

VENTILATION SOLUTIONS FOR HOMES

VMC

VENTILATION
SYSTEMS
FOR **HOMES**

PRESSURISATION OF **STAIRCASES,**
LOBBIES AND EVACUATION ROUTES
IN THE EVENT OF FIRE

CAR PARK
VENTILATION



IDEAL FOR PASSIVE
HOMES



ENERGY SAVINGS



Well-being and comfort
at home with
efficient ventilation
from SODECA

SODECA, specialist in efficient ventilation solutions for healthy and quality indoor air	4
Summary of SODECA's residential ventilation solutions	6
GENERAL INFORMATION ABOUT RESIDENTIAL VENTILATION	
Controlled mechanical ventilation for homes	8
Single-family residence and collective residential ventilation	11
Single flow and double flow systems	12
Double flow with heat recovery systems	13
Housing rehabilitation	14
BUILDING REFERENCE REGULATIONS	
ANSI/ASHRAE Standard 62.2. Ventilation and Indoor Air Quality in Residential Buildings	15
Passivhaus Certification	16
VENTILATION SOLUTIONS FOR HOMES	
SINGLE-FAMILY residence ventilation	17
· Single flow	18
· Single flow. Airhome One KIT	20
· Double flow with heat recovery	23
· Double flow with heat recovery. Airhome KIT	30
· Accessories	31
COLLECTIVE residential ventilation	33
· Single flow	34
· Single flow with constant pressure control	36
· Double flow with heat recovery	38
PRESSURISATION SOLUTIONS FOR STAIRCASES, LOBBIES AND EVACUATION ROUTES IN THE EVENT OF FIRE	40
VENTILATION SOLUTIONS FOR CAR PARKS	42
OTHER SOLUTIONS	44



The environmental management system at SODECA's headquarters is ISO 14001 certified by Bureau Veritas

SODECA, specialist in efficient ventilation solutions for healthy and quality indoor air





Adequate ventilation is essential for well-being and comfort at home. SODECA's ventilation solutions for homes are designed to provide a healthy environment efficiently. SODECA's extensive experience in the industrial ventilation field allows it to apply all the knowledge acquired in demanding environments to improve the indoor air of all types of buildings.

Since its beginnings, SODECA has grown by seeking the best path, always innovating and

providing the best customer service, respecting the environment and promoting energy efficiency. This approach, focused on the well-being of people and sustainability, drives SODECA to continue advancing towards a healthier and more comfortable future in enclosed environments. For this reason, ventilation and air treatment solutions meet the highest quality standards and comply with current regulations, ensuring that the air we breathe in our homes is safe and healthy.

Ventilation in **SINGLE-FAMILY** residences



**Efficient ventilation to
comply with regulations
and improve quality of life**

We offer adapted ventilation solutions for homes, with systems that improve the air quality in living spaces. We also design specific solutions for the pressurisation of staircases in emergency situations and ventilation for car parks, guaranteeing safety and regulatory compliance.

**Pressurisation of staircases,
lobbies and evacuation routes
in the event of fire**
EN 12101-6 standard

Ventilation systems for homes

Código Técnico de la Edificación (CTE)
(Technical Building Code)
Royal Decree 235/2013
Passivhaus Certification



Ventilation in **COLLECTIVE** housing



Ventilation solutions for healthy and sustainable spaces

Our systems for collective housing provide centralised ventilation for multiple homes, optimising energy consumption and ensuring uniform distribution of clean air. These solutions can be complemented with pressurisation systems and ventilation in common areas, such as staircases and car parks, maximising efficiency and safety in buildings.

Pressurisation of staircases, lobbies and evacuation routes in the event of fire
EN 12101-6 standard

Ventilation systems for homes

Código Técnico de la Edificación (CTE) (Technical Building Code)
Royal Decree 235/2013
Passivhaus Certification

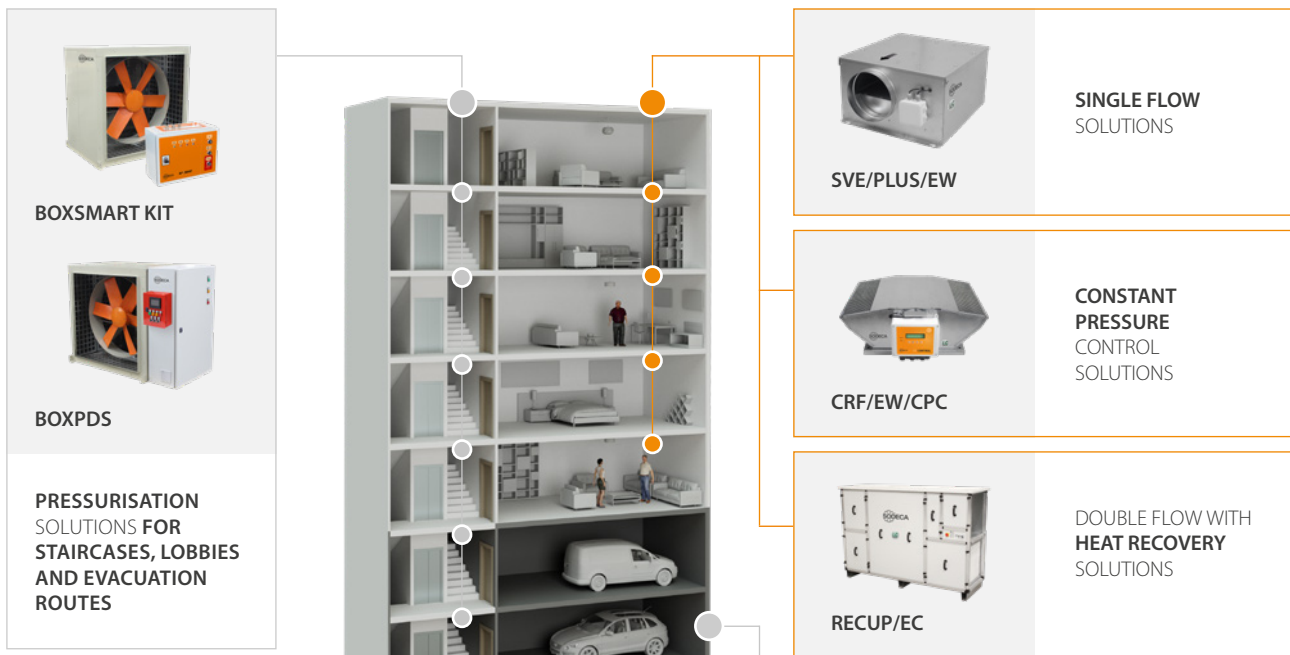

Car park ventilation

CTE DB SI y DB HS, and the UNE 100166 standard

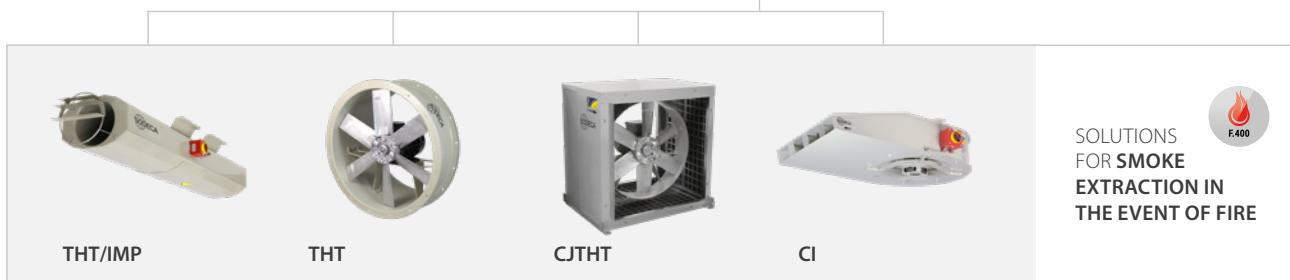

CONTROLLED MECHANICAL VENTILATION FOR HOMES



POLLUTANTS

- Allergens
 - Mites
 - Animals
 - Pollen
- VOC (Volatile Organic Compounds)
- CO (Carbon Monoxide)
 - Paint
 - Glues
 - Solvents
 - Bleaches
 - Ammonia
- Humidity
- Water vapour
- Odours
- Burned gases
- Hydrocarbons
- CO₂ (Carbon Dioxide)
- Fine particles
 - Smoke
 - Tobacco
 - Radon gas

30%
of the European population suffers from allergies
and is affected by bad indoor air quality.

50%
of homes are contaminated, and children are affected the most,
given that, due to their constitution and development, they inhale double the pollutants of an adult.

90%
the time we spend in enclosed spaces where pollutants that we inhale are concentrated.

Indoor air is 8 times more polluted than outdoor air.
In large population centres, pollution is very high, which is why the air entering the system must be filtered to prevent pollutants from entering the home.

CONTROLLED MECHANICAL VENTILATION (CMV)

Systems with controlled mechanical ventilation and purification filter the outside air in order to retain pollen, fine particles and bacteria, while the inside air is extracted to release CO₂, humidity and volatile organic compounds (VOCs).



THE CTE (TECHNICAL BUILDING CODE) AND CONTROLLED MECHANICAL VENTILATION

The Technical Building Code (CTE) establishes the standards and rules to be applied to ensure effective ventilation of the home, guaranteeing greater comfort for the occupants and protecting the home against condensation.

RISK OF CONTAGION

According to some scientists, **in poorly ventilated indoor spaces, the risk of contracting airborne diseases can be up to 20 times higher than outside.**

RISK OF MOISTURE AND CONDENSATION

Homes in the past suffered from air infiltration due to their poor airtightness, which led to significant energy losses. Currently, however, they tend to have reinforced air-tightness, which is the cause of deficient inside air and can lead to the risk of condensation. Controlled Mechanical Ventilation (CMV) is therefore indispensable.

RADON GAS

Radon is a naturally occurring radioactive gas that can be found suspended in indoor spaces, such as homes and workplaces. It is currently estimated that it is the second cause of lung cancer in Spain, only behind tobacco, causing up to 14% of these conditions. Controlled Mechanical Ventilation (CMV) strategies can remove the danger of radon exposure.

Ventilation control



SELF-REGULATING CONTROL

The system is based on maintaining a constant, permanent flow rate in each part of the dwelling. It's the simplest form of control. The fans are used in combination with constant flow rate nozzles during the extraction process.



SENSOR CONTROL

This system is based on ventilating at a variable flow rate, depending on the readings of one or more sensors. It maintains optimum air quality, with minimum energy consumption.



Controlled Mechanical Ventilation System



IDEAL FOR PASSIVE HOMES



ENERGY SAVINGS

Controlled Mechanical Ventilation (CMV) systems are an integrated solution designed to optimise their quality in enclosed spaces and provide healthy and comfortable indoor environments.

It is essential to have advanced systems that ensure adequate ventilation, reducing the accumulation of pollutants and maintaining a safe environment at all times. SODECA's Controlled Mechanical

Ventilation solutions are focused on energy efficiency, sustainability and the well-being of those occupying the space.

“Thanks to an efficiency of up to 92%, a CMV system pays for itself in less than two years, recouping the investment made and allowing us to achieve considerable savings year after year.”



FILTRATION

Controlled mechanical ventilation and purification systems filter the outside air to retain pollen, fine particles and bacteria.



AIR TREATMENT UNITS

CMV solutions improve the quality of indoor spaces by allowing the entry of filtered air and removing exhaust air and humidity.



THERMAL AND ACOUSTIC INSULATION

Reduced noise and vibration, greater energy efficiency and durability. Thermal insulation also reduces heat and cold, losses, resulting in significant energy and economic savings.



SINGLE-FAMILY RESIDENCE AND COLLECTIVE RESIDENTIAL VENTILATION

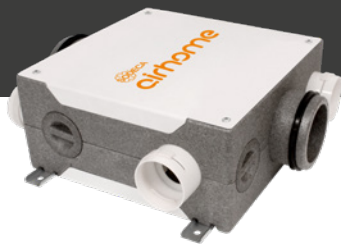

SINGLE-FAMILY RESIDENCE VENTILATION

This ventilation system is precisely adapted to the particular needs of each home, considering the characteristics and dimensions of the space. Thanks to a detailed analysis of the air inlets and outlets, constant and efficient air renewal is guaranteed, which significantly improves the quality of the indoor environment.

Occupants can fully control the operation of the system, adjusting it to their comfort preferences and optimising energy consumption, by adapting it to the actual demand of each home.

In addition, by not depending on a centralised system, the usual drawbacks associated with shared systems are eliminated.

Each home has its own ventilation system, which facilitates its maintenance and gives residents greater autonomy and control over their environment.



COLLECTIVE RESIDENTIAL VENTILATION

This centralised system is designed to manage air renewal in multiple homes, being ideal for residential buildings, offices or public spaces.

Air management is an essential aspect to maintain a healthy and comfortable environment for occupants. Implementing a single, centralised system helps to more efficiently control the airflow, ensuring adequate circulation throughout the building and helping to improve the indoor air quality.

The main advantages of this system include the reduced initial cost, as unifying the operation from a single point minimises equipment and installation costs. Maintenance is also centralised, which reduces the burden of responsibility for residents and makes the system easier to manage. The simplified design of this system makes it an ideal option for buildings with similar structures, as it facilitates both planning and implementation, reducing the complexity of the project and the space required, by eliminating the installation of individual units in each home.

In both cases, for both single-family residence and collective residential ventilation, single flow and double flow systems can be used.

SINGLE FLOW AND DOUBLE FLOW SYSTEMS

There are two types of systems available for installing controlled mechanical ventilation in homes



SINGLE FLOW SYSTEM

In this system, fresh air enters the home due to pressure differences, through openings in the façade.

Exhaust air inside the home is expelled through an extract fan, thus ensuring continuous renewal of the indoor air.

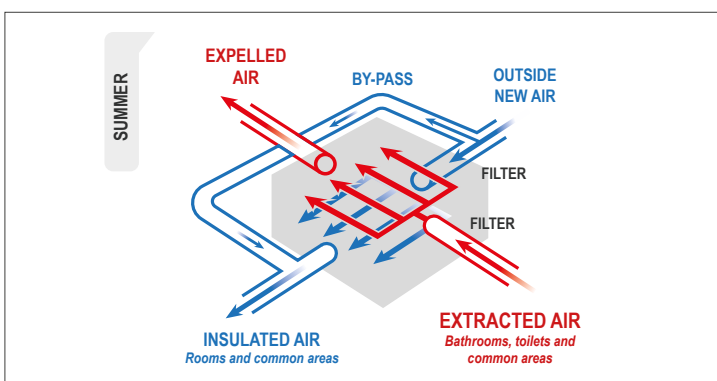
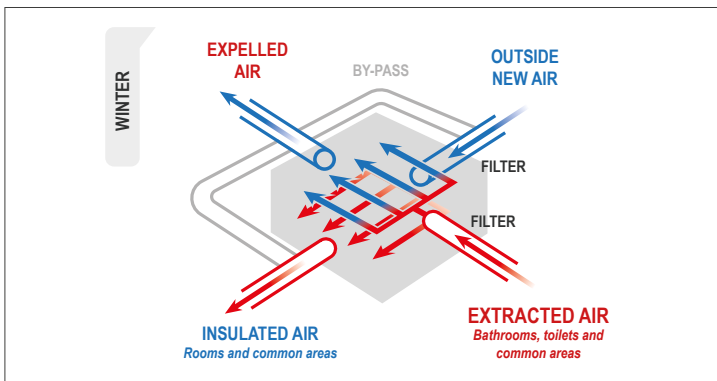
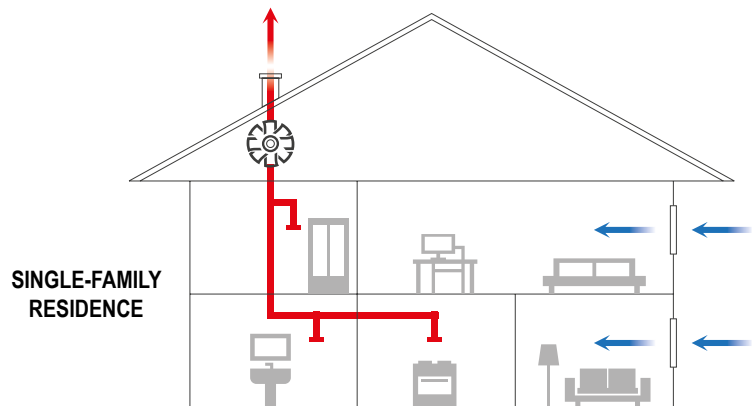

DOUBLE FLOW SYSTEM

This double flow system improves energy efficiency and comfort by crossing the supply and extraction flows to maintain a pleasant temperature inside the home.

In winter, it pre-heats the outside air before introducing it into the home, while in summer it cools it, ensuring constant air renewal with minimum energy loss. This helps maintain a comfortable environment throughout the year with reduced energy consumption. This technology has a heat exchanger that can be of the enthalpy type, ideal for environments with excess or lack of humidity, or heat-sensitive. It also incorporates inlet and outlet filters and fans with EC technology.

DOUBLE FLOW WITH HEAT RECOVERY SYSTEMS

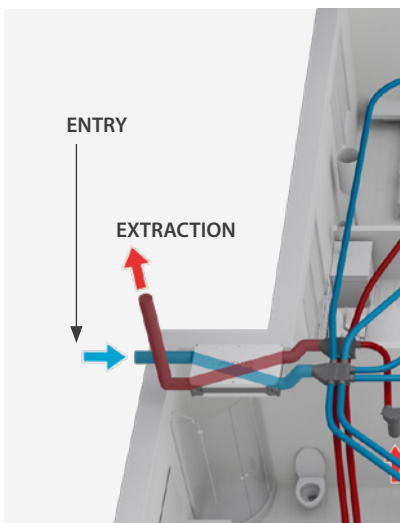
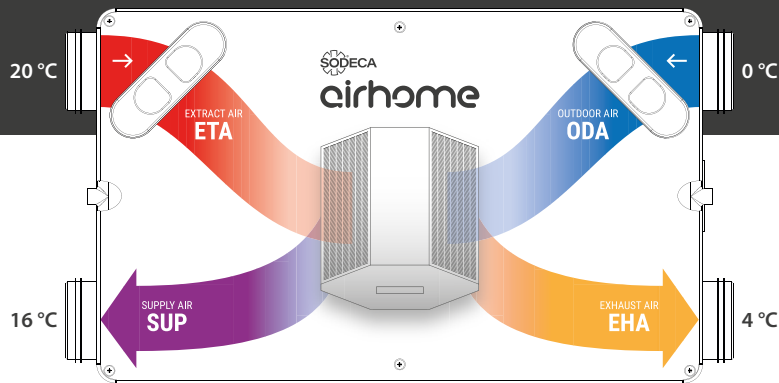

Cross-flow panels

85-90% thermal efficiency
With no leaks between air circuits

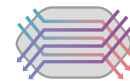

ENTHALPY-TYPE OR HEAT SENSITIVE HEAT EXCHANGER

Heat exchangers may be the heat-sensitive or the enthalpy type. The heat-sensitive heat exchanger recovers heat present in the air, while the enthalpy type heat exchanger also recovers humidity, so efficiency may be greater in very humid environments (they still require regular cleaning for safe operation).

The heat exchanger component in the recovery unit transfers heat from the exhaust air extraction circuit to the external clean air supply circuit. The greater the thermal efficiency of the exchanger, the less need there will be to supply additional air conditioning.

Types of installation



FALSE CEILING

Low-profile equipment with access to components through the side or base.



ROOF

Equipment for outdoor operation, with lateral access to components. They may require accessories for protection against the rain or other elements.



WALL

Compact equipment with front access.

Housing rehabilitation



Energy efficiency

Energy efficiency and housing rehabilitation addresses several key aspects, with economic and environmental benefits:

- Reduced energy consumption
- Economic savings
- Reduced polluting emissions



Indoor air quality

Indoor air quality is a fundamental aspect in housing rehabilitation, with direct impacts on the health of residents and the preservation of the building:

- Improved health
- Conservation of the existing building



Comfort

Comfort in housing rehabilitation addresses different dimensions to ensure a pleasant and functional environment. Considering thermal comfort, sound and odour control significantly improves the experience of living in the rehabilitated space:

- Thermal comfort
- Sound control
- Odour control



Innovative technologies

Integrating innovative technologies in housing rehabilitation provides advanced functionalities, efficiency and comfort:

- Home automation
- Heat recovery

SODECA SOLUTIONS



AIRHOME-150



AIRHOME-200/300



AIRHOME-350/V



EVP



EVM



UNIREC



EDMF



EDQUIET/S



EDD



AIRHOME ONE

ANSI/ASHRAE Standard 62.2. Ventilation and Indoor Air Quality in Residential Buildings



Standard 62.2 is the consensus document developed by the **American Society of Heating, Refrigerating and Air-Conditioning Engineers (ASHRAE)** to address Indoor Air Quality issues in homes.

This standard describes the **minimum ventilation requirements** considered necessary to reduce pollutants in living spaces.



Minimum ventilation requirements in dwellings

The standard establishes the guidelines to calculate the minimum ventilation flow rate in dwellings based on the total area, the number of rooms and whether or not mechanical filtration is used.

The double flow with heat recovery units allow this ventilation to be implemented efficiently, enabling savings in annual heating and air conditioning consumption.

Furthermore, the use of units with a minimum filtration of F6 (MERV 11) allows the design flow rate to be reduced by 20%, due to the "Filtration Credit" included in the standard. In this regard, AIRHOME models even exceed this requirement by incorporating F7 filters (MERV 13).



Passivhaus Certification



Passivhaus certification is a voluntary standard that certifies new or renovated buildings that are designed to maximise energy efficiency and indoor air quality, while reducing greenhouse gas emissions.

The certification is closely linked to the climate of the environment, as thermal insulation requirements vary depending on weather conditions. The certification is therefore subdivided into specific climate sections, differentiated from each other in terms of temperature, from the coldest to the warmest.

At SODECA we optimise the comfort and energy efficiency of your home, regardless of the climate

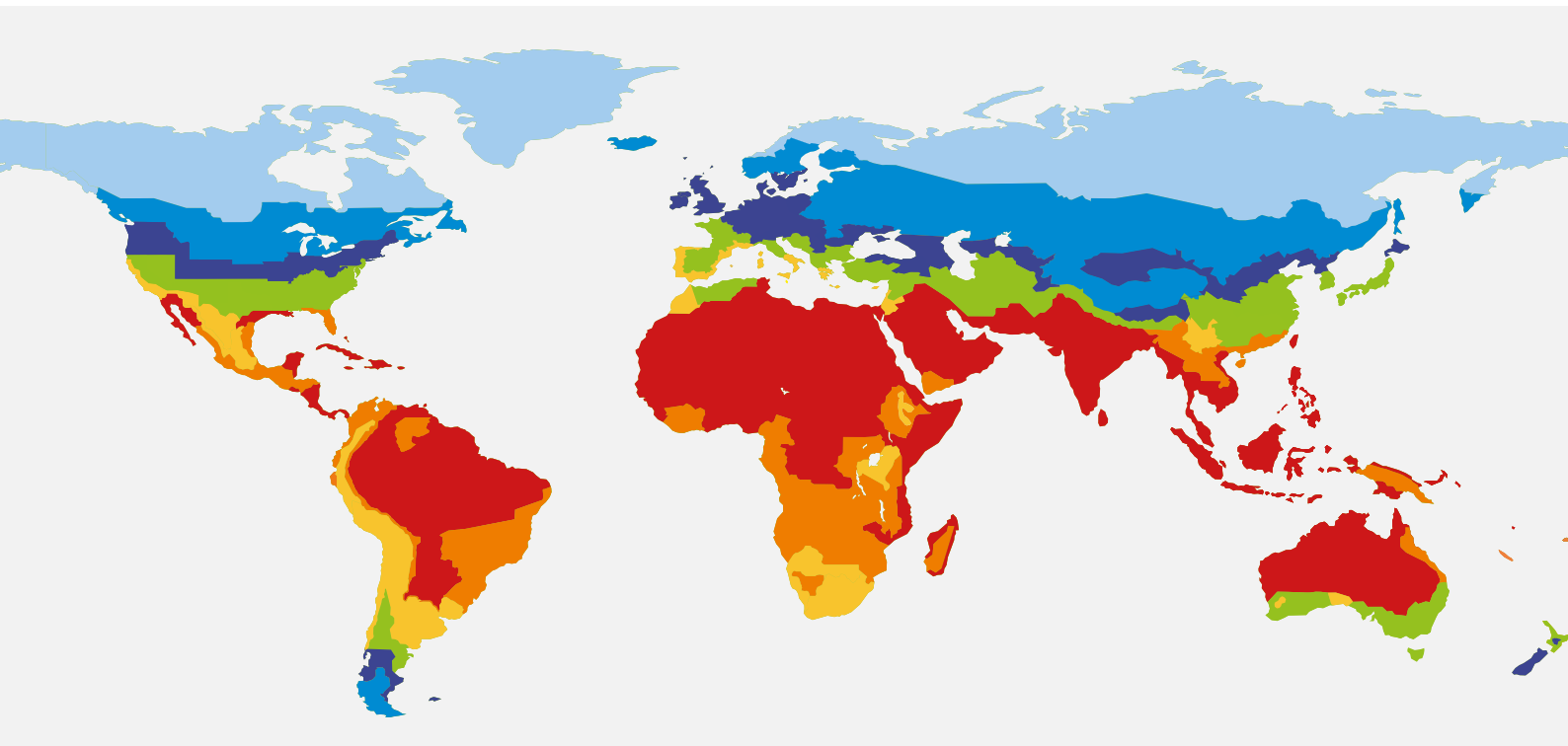

VENTILATION SOLUTIONS FOR HOMES

SINGLE-FAMILY RESIDENCE VENTILATION



SINGLE FLOW SYSTEM



AIRHOME ONE



EVM



EVP

DOUBLE FLOW WITH HEAT RECOVERY SYSTEM

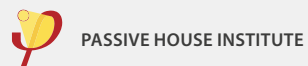

AIRHOME-150



AIRHOME-200/300

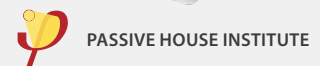

AIRHOME-350/V



UNIREC

SINGLE-FAMILY residence ventilation SINGLE FLOW



Single flow ventilation enables **the simple renewal of indoor air**, extracting air from humid areas such as the kitchen and bathrooms in the home through ducts to the outside. The renewed air is introduced through the air inlets in bedrooms and living/

dining rooms (dry rooms). The single-flow system automatically guarantees the extraction flow rates and a daily and permanent renewal of air in the home required by current regulations.



The perfect solution to meet the minimum requirements of current regulations

Benefits



Renews air simply and efficiently



Simple maintenance and assembly



Reduces humidity, condensation and dilutes pollutants

SINGLE-FAMILY
residence ventilation
SINGLE FLOW



Controlled Mechanical Ventilation System

This system is based on air sweep ventilation by extracting exhaust air through the wet rooms. Fresh air enters through grilles in the dry rooms.

**Maximum flow rate of
298 m³/h**

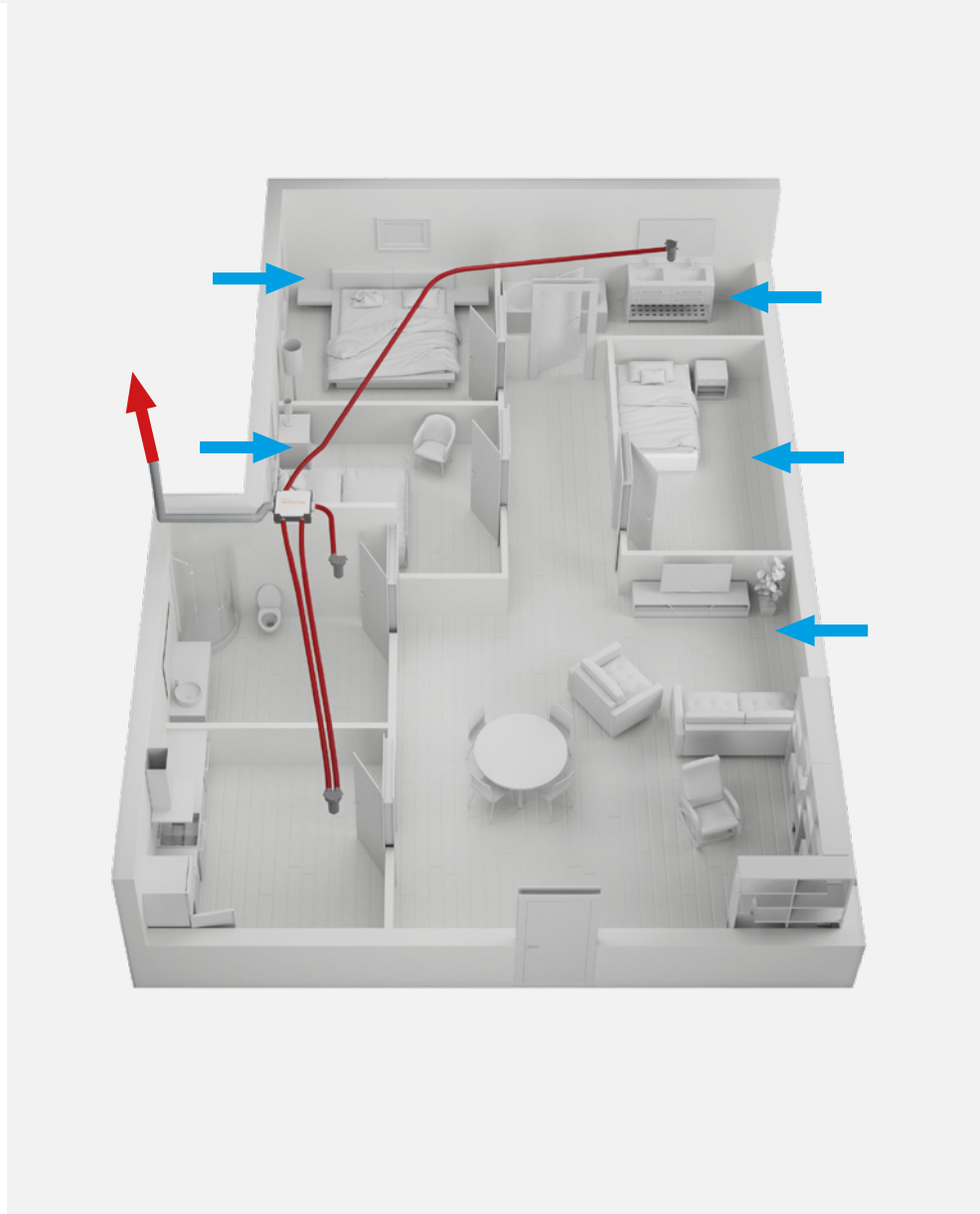

SODECA SOLUTIONS



AIRHOME ONE



EVP



EVM

SINGLE-FAMILY residence ventilation
SINGLE FLOW
AIRHOME ONE KIT



AIRHOME ONE

2H/1B



This type of home, which includes three dry rooms (living room and two bedrooms) and two wet rooms (bathroom and kitchen) **according to CTE must be ventilated with a minimum flow rate of 86.4 m³/h.**

SODECA recommends the following flows:

- **EXTRACTION**
- Kitchen: 60 m³/h
- Bathroom: 30 m³/h

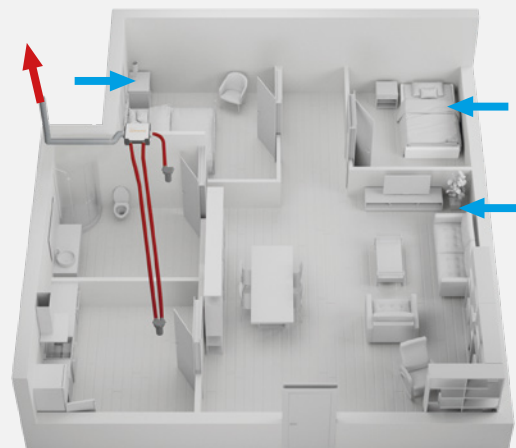

SINGLE-FAMILY residence ventilation
SINGLE FLOW
AIRHOME ONE KIT

3H/2B



3 BED-ROOMS



2 BATH-ROOMS

This type of home, which includes four dry rooms (living room and three bedrooms) and three wet rooms (two bathrooms and kitchen) **according to CTE must be ventilated with a minimum flow rate of 118.8 m³/h.**

SODECA recommends the following flows:

■ EXTRACTION

Kitchen: 60 m³/h

Bathroom: 30 m³/h

Bathroom: 30 m³/h

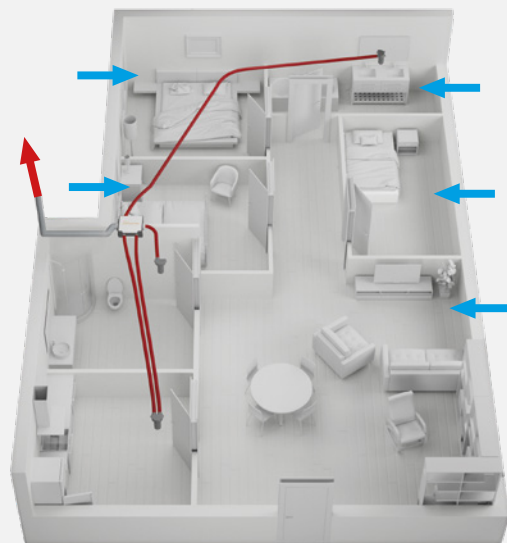

4H/2B



4 BED-ROOMS



2 BATH-ROOMS

This type of home, which includes five dry rooms (living room and four bedrooms) and three wet rooms (two bathrooms and kitchen) **according to CTE must be ventilated with a minimum flow rate of 118.8 m³/h.**

SODECA recommends the following flows:

■ EXTRACTION

Kitchen: 60 m³/h

Bathroom: 30 m³/h

Bathroom: 30 m³/h

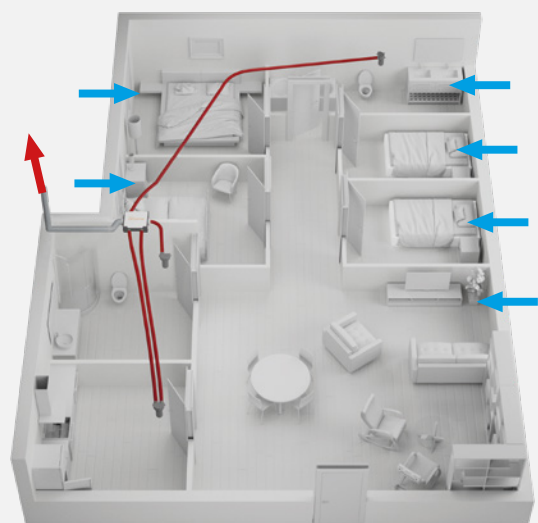

SINGLE-FAMILY residence ventilation
SINGLE FLOW
AIRHOME ONE KIT

BASIC OPTION

COMPONENTS:

ITEM CODE	PRODUCT NAME	QUANTITY
1508272	AIRHOME ONE BASIC	1
ITEM CODE	PRODUCT NAME	QUANTITY
1508274	KIT-AIRHOME ONE BASIC:	1
Contains:		
	VMC-PL 2X75	3
	VMC-CSR 75 25m	1
	VMC-EXT DN125	3
	VMC-RC 125	3
	BE-AC 125	3

AIRHOME ONE KIT

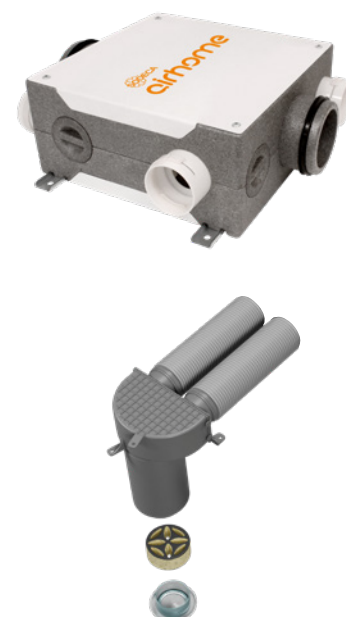

PREMIUM OPTION

Ventilation system with CO₂ temperature and humidity sensors included.

COMPONENTS:

ITEM CODE	PRODUCT NAME	QUANTITY
1508273	AIRHOME ONE PREMIUM	1
ITEM CODE	PRODUCT NAME	QUANTITY
1508275	KIT-AIRHOME ONE PREMIUM:	1
Contains:		
	VMC-PL 2X75	3
	VMC-CSR 75 25m	1
	VMC-EXT DN125	3
	VMC-RC 125	3
	BE-AC 125	3

SINGLE-FAMILY residence ventilation
**DOUBLE FLOW WITH
 HEAT RECOVERY**



Double flow ventilation with heat recovery allows indoor air to be renewed by extracting exhaust, energy-laden air from wet rooms. Outdoor air enters through the dry rooms. This area is treated inside the heat recovery unit, where the energy

of the extracted air is used, and it is also filtered to ensure better air quality. This process and increase in air renewal inside the homes ensures spaces free of pollutants, microbes, viruses and allergens.



AIRHOME solutions recover the existing energy in homes to reduce the carbon footprint

Benefits



Control airflow by zones and with low noise level









Ensure optimal air quality thanks to its filtration system



Avoid energy losses. Energy savings

SINGLE-FAMILY residence ventilation
DOUBLE FLOW WITH HEAT RECOVERY

 CONTROLLED MECHANICAL VENTILATION	 COUNTERFLOW PLATE HEAT EXCHANGER	 HIGH EFFICIENCY AND LOW CONSUMPTION
 THERMAL AND ACOUSTIC INSULATION	 EC TECHNOLOGY MOTORS	 BUILT-IN BY-PASS



Low noise level
Very quiet with only 26dB(A)



Low-profile compact design
210 mm high (Airhome 150)

SINGLE-FAMILY residence ventilation
DOUBLE FLOW WITH HEAT RECOVERY



Interchangeable nozzles
according to the position of the unit



Easy installation
on false ceiling or wall



Removable F7
high-efficiency filters



Condensate exhaust
for enthalpy-type or heat
sensitive heat exchanger

SINGLE-FAMILY residence ventilation
DOUBLE FLOW WITH HEAT RECOVERY



Ventilation control
Smarthome-Aidoo Pro

It uses MODBUS communications, allowing remote and intuitive control of the equipment. Smooth and reliable connection between the control system and equipment, enabling monitoring and adjustment from anywhere via an app. Modern and easy-to-use solution to control the operation of the ventilation systems both in commercial and residential environments.

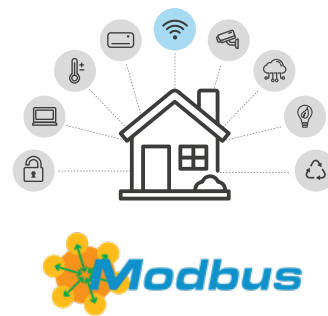

Remote control and IAQ sensors
 (T, RH, CO₂, TCOV) built in

Compatible with
Modbus RTU

SINGLE-FAMILY residence ventilation
DOUBLE FLOW WITH HEAT RECOVERY

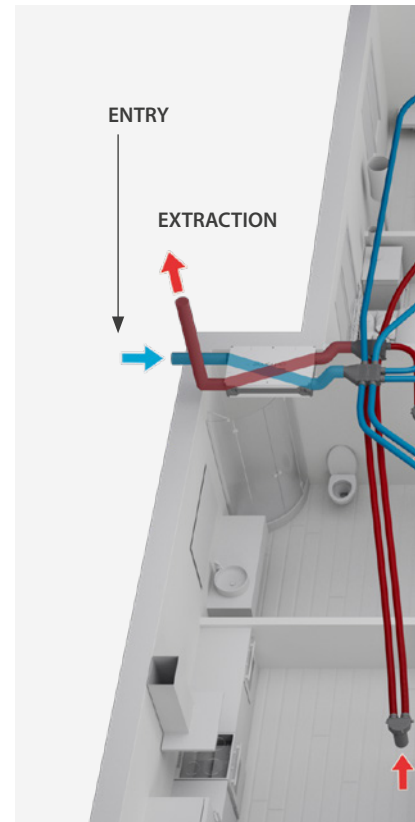
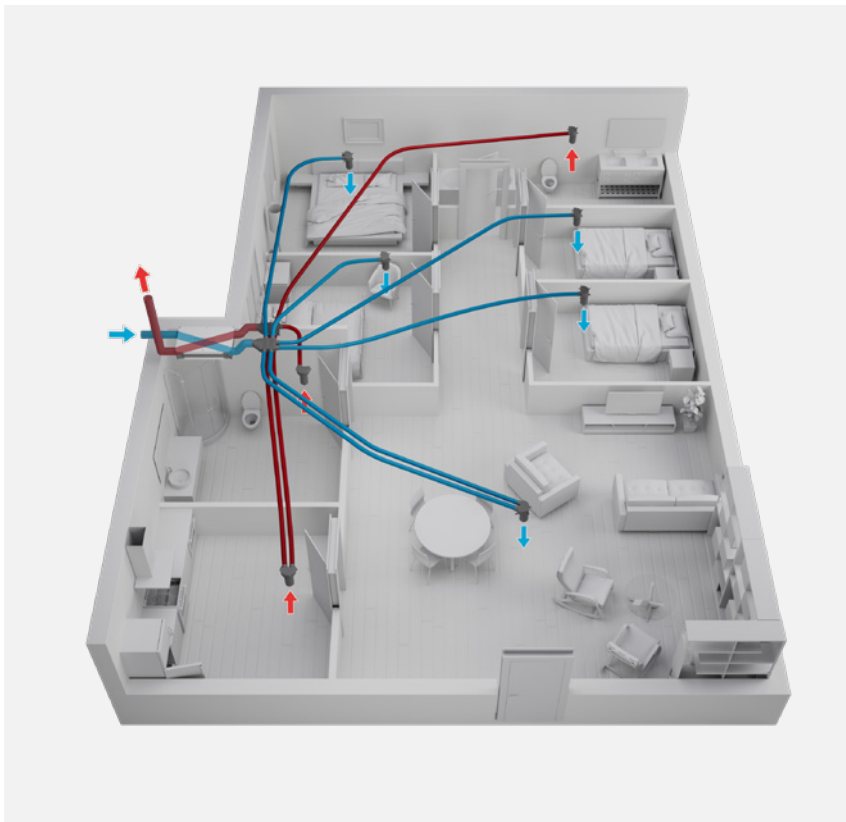

Cross-flow panels

85-90% thermal efficiency. With no leaks between air circuits.

SODECA **SOLUTIONS**

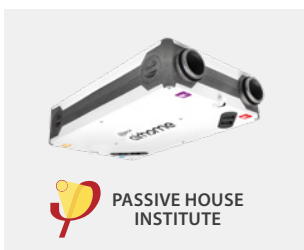

AIRHOME-150



AIRHOME-200/300



AIRHOME-350/V



UNIREC

SINGLE-FAMILY residence ventilation
DOUBLE FLOW WITH HEAT RECOVERY

2H/1B

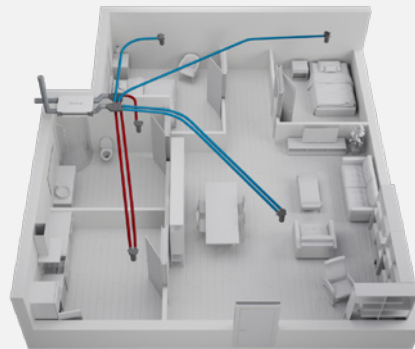

This type of home, which includes three dry rooms (living room and two bedrooms) and two wet rooms (bathroom and kitchen) **according to CTE must be ventilated with a minimum flow rate of 86.4 m³/h.**

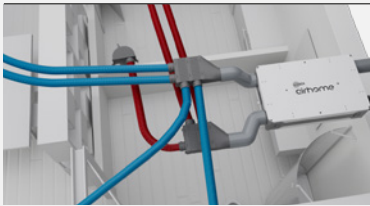

SODECA recommends the following flows:

■ EXTRACTION
 Kitchen: 60 m³/h
 Bathroom: 30 m³/h

■ ENTRY
 Master bedroom: 30 m³/h
 Bedroom: 15 m³/h
 Living room: 45 m³/h

COMPONENTS:

ITEM CODE	PRODUCT NAME	QUANTITY
-----------	--------------	----------

1353781	AIRHOME-150	1
---------	--------------------	---

ITEM CODE	PRODUCT NAME	QUANTITY
-----------	--------------	----------

1501058	KIT-AIRHOME-2H/1B	1
---------	--------------------------	---

Contains:

	AIRHOME-150	1
	BE-AC-125	2
	BI-AC-125	3
	VMC-CLP 125 + 4X75	2
	VMC-PL 2X75	5
	VMC-EXT DN125	5
	VMC-RC 125	5
	VMC-CSR 75 50M	1
	VMC-JG 75 50U	1

KIT-AIRHOME-2H/1B

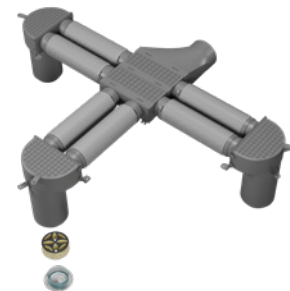

SINGLE-FAMILY residence ventilation
DOUBLE FLOW WITH HEAT RECOVERY
AIRHOME KIT

3H/2B



3 BED-ROOMS



2 BATH-ROOMS

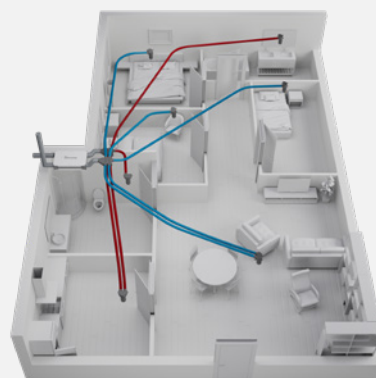

This type of home, which includes four dry rooms (living room and three bedrooms) and three wet rooms (two bathrooms and kitchen) **according to CTE must be ventilated with a minimum flow rate of 118.8 m³/h.**



SODECA recommends the following flows:

■ EXTRACTION

- Kitchen: 60 m³/h
- Bathroom: 30 m³/h
- Bathroom: 30 m³/h

■ ENTRY

- Master bedroom: 30 m³/h
- Bedroom: 15 m³/h
- Bedroom: 15 m³/h
- Living room: 60 m³/h

COMPONENTS:

ITEM CODE	PRODUCT NAME	QUANTITY
-----------	--------------	----------

1353781	AIRHOME-150	1
---------	--------------------	---

ITEM CODE	PRODUCT NAME	QUANTITY
-----------	--------------	----------

1501059	KIT-AIRHOME-3H/2B	1
---------	--------------------------	---

Contains:

	AIRHOME-150	1
	BE-AC-125	3
	BI-AC-125	4
	VMC-CLP 125 + 4X75	2
	VMC-ME 2X75	1
	VMC-PL 2X75	7
	VMC-EXT DN125	7
	VMC-RC 125	7
	VMC-CSR 75 50M	2
	VMC-JG 75 50U	1

KIT-AIRHOME-3H/2B



SINGLE-FAMILY residence ventilation
DOUBLE FLOW WITH HEAT RECOVERY
AIRHOME KIT

4H/2B



4 BED-ROOMS



2 BATH-ROOMS

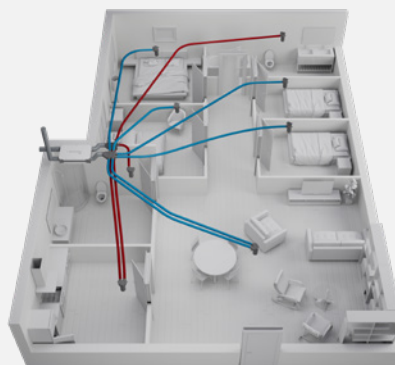

This type of home, which includes five dry rooms (living room and four bedrooms) and three wet rooms (two bathrooms and kitchen) **according to CTE must be ventilated with a minimum flow rate of 118.8 m³/h.**

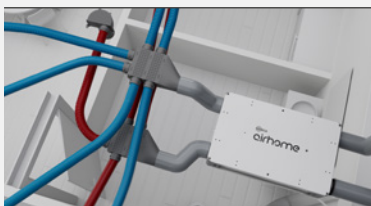

SODECA recommends the following flows:

■ EXTRACTION

- Kitchen: 60 m³/h
- Bathroom: 30 m³/h
- Bathroom: 30 m³/h

■ ENTRY

- Master bedroom: 30 m³/h
- Bedroom: 15 m³/h
- Bedroom: 15 m³/h
- Bedroom: 15 m³/h
- Living room: 45 m³/h

COMPONENTS:

ITEM CODE	PRODUCT NAME	QUANTITY
-----------	--------------	----------

1353781	AIRHOME-150	1
---------	--------------------	---

ITEM CODE	PRODUCT NAME	QUANTITY
-----------	--------------	----------

1501060	KIT-AIRHOME-4H/2B	1
---------	--------------------------	---

Contains:

	AIRHOME-150	1
	BE-AC-125	3
	BI-AC-125	5
	VMC-CLP 125 + 4X75	2
	VMC-ME 2X75	1
	VMC-PL 2X75	8
	VMC-EXT DN125	8
	VMC-RC 125	8
	VMC-CSR 75 50M	3
	VMC-JG 75 50U	1

KIT-AIRHOME-4H/2B



ACCESSORIES

Accessories for ventilation in homes
AIRHOME KIT

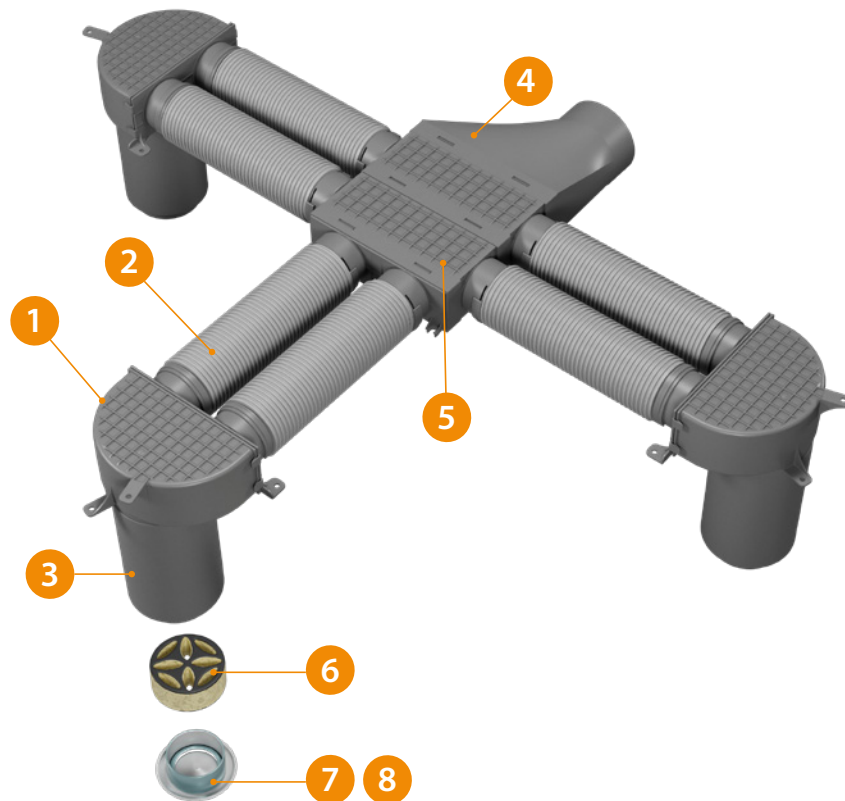

INCLUDED IN THE KIT:





ITEM CODE	1505609	1505618	1505612	1505607	1505606	1505613	1023946	1023950
PRODUCT NAME	VMC-PL 2X75	VMC-CSR 75 50M	VMC-EXT DN125	VMC-CLP 125 + 4X75	VMC-ME 2X75	VMC-RC 125	BE-AC 125	BI-AC 125

The 1505617 VMC-JG 75 50U code is not represented, but it is included in the kit.

ACCESSORIES

Accessories for ventilation in homes
AIRHOME KIT

	ITEM CODE	PRODUCT NAME		ITEM CODE	PRODUCT NAME
	1023946	BE-AC-125		1353044 1353046	VMC-ADR 125 VMC-ADR 160
	1023950	BI-AC-125		1352997 1352999	VMC-ADK 125 VMC-ADK 160
	1505613	VMC-RC 125		1353008 1353010	VMC-ADL 125 VMC-ADL 160
	1505609	VMC-PL 2X75		1353040 1353042	VMC-AN 125 VMC-AN 160
	1505612	VMC-EXT DN125		1505616	VMC-R 75
	1505618 1505619	VMC-CSR 75 50M VMC-CSR 75 25M		1505617	VMC-JG 75 50U
	1505606	VMC-ME 2X75		1505620	VMC-CUTTER
	1505607 1505608	VMC-CLP 125 + 4X75 VMC-CLP 160 + 4X75		1505621	VMC-PLNC
	1505610 1505611	VMC-CCP 125 + 8X75 VMC-CCP 160 + 8X75		1505622	VMC-TPN 75
	1505614 1505615	VMC-BL 125 10M VMC-BL 160 10M		1505623	VMC-MGT 75

COLLECTIVE RESIDENTIAL VENTILATION

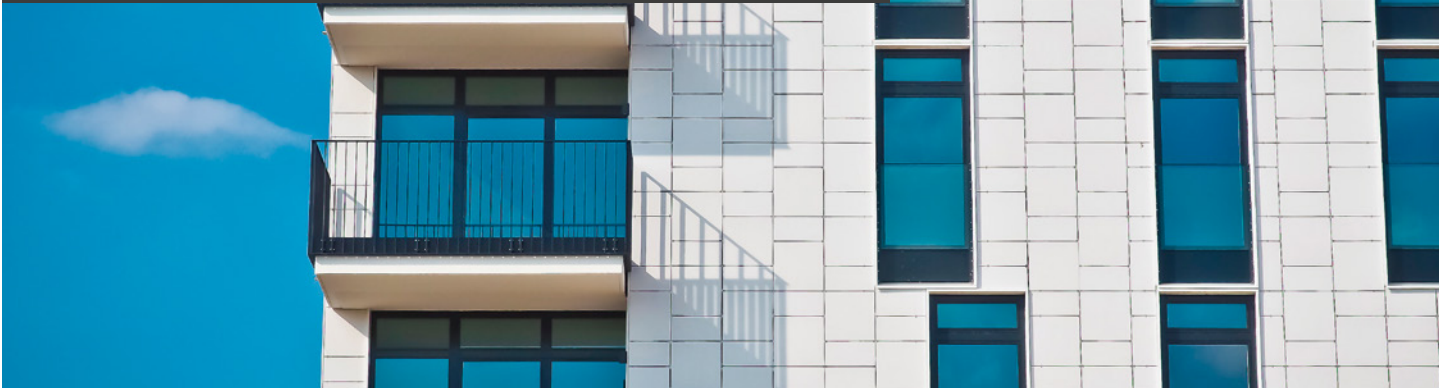

SINGLE FLOW SYSTEM



SVE/PLUS/EW

CONSTANT PRESSURE CONTROL



CRF/EW/CPC

DOUBLE FLOW WITH HEAT RECOVERY SYSTEM

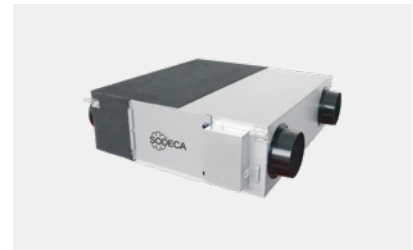

REB



CRF/EW



RECUP/EC BS



CTD



RECUP/EC H

COLLECTIVE residential ventilation SINGLE FLOW

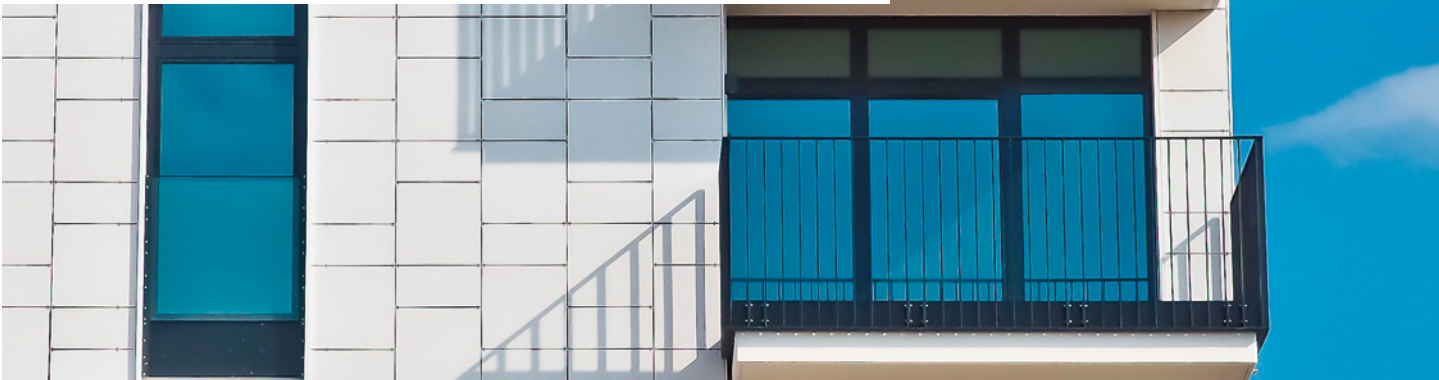

The single flow collective residential ventilation system is an efficient solution to renew air in buildings with multiple homes. It extracts the exhaust air from wet rooms such as kitchens and bathrooms through

ducts to the outside, and also introduces fresh air into dry rooms such as bedrooms and living room/dining rooms through the air inlets.



Simpler installation and maintenance

Benefits



Improves comfort by extracting exhaust air



Renews air simply



Easy to maintain

COLLECTIVE residential ventilation
SINGLE FLOW

A system that combines natural air entry into dry rooms, and an extraction system via ducts in wet rooms.

It allows flow rate regulation through adjustable nozzles. The main advantage is **its simplicity, as it does not require a dual duct system.**

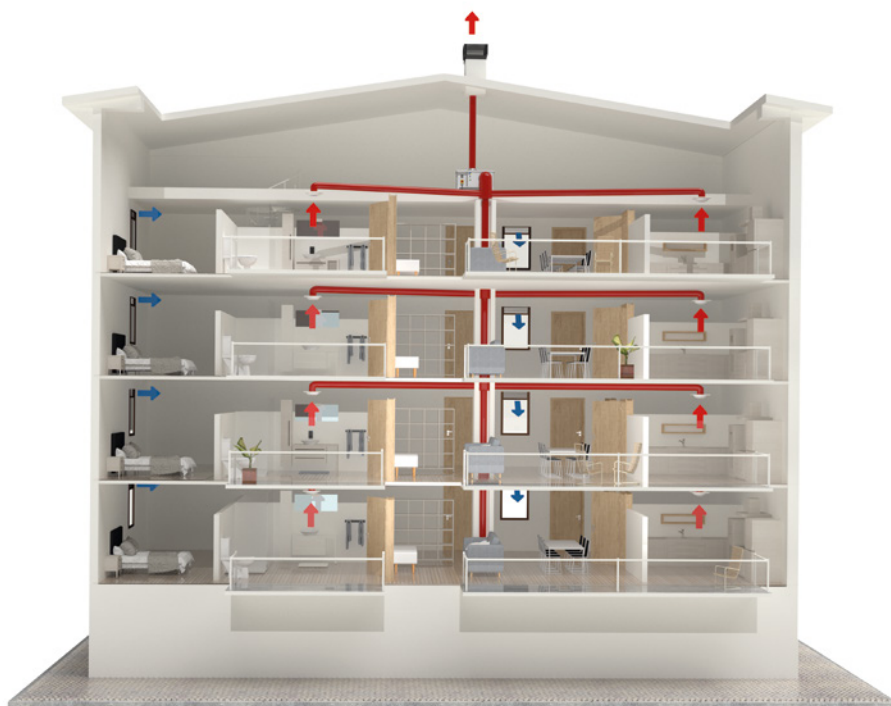

SODECA **SOLUTIONS**



SVE/PLUS/EW



CRF/EW



CTD

COLLECTIVE residential ventilation SINGLE FLOW WITH CONSTANT PRESSURE CONTROL



The CPC system allows the fan to operate automatically, using a built-in pressure sensor and electronic control to adjust the speed of the ventilation unit to the requirements of each facility. This allows a constant pressure in the duct system regardless of the number of homes and the number of extraction inlets, thereby adapting the airflow to the needs of each home.

This control system, which acts with our EC TECHNOLOGY fans, provides the best solution for all kinds of facilities, obtaining much higher energy cost savings than any other unit. It also maintains a perfect balance between the ventilation needs of each home, minimal power consumption and low noise level.



Single flow mechanical ventilation
ideal for collective facilities

Benefits



Guarantees good
air quality



Energy savings of 70%, thanks
to the EC TECHNOLOGY and
speed control



Ensures constant pressure
in duct system

COLLECTIVE residential ventilation
SINGLE FLOW WITH CONSTANT PRESSURE CONTROL



SODECA's fans with CPC have been especially designed for controlled mechanical ventilation systems in multi-family or communal buildings.

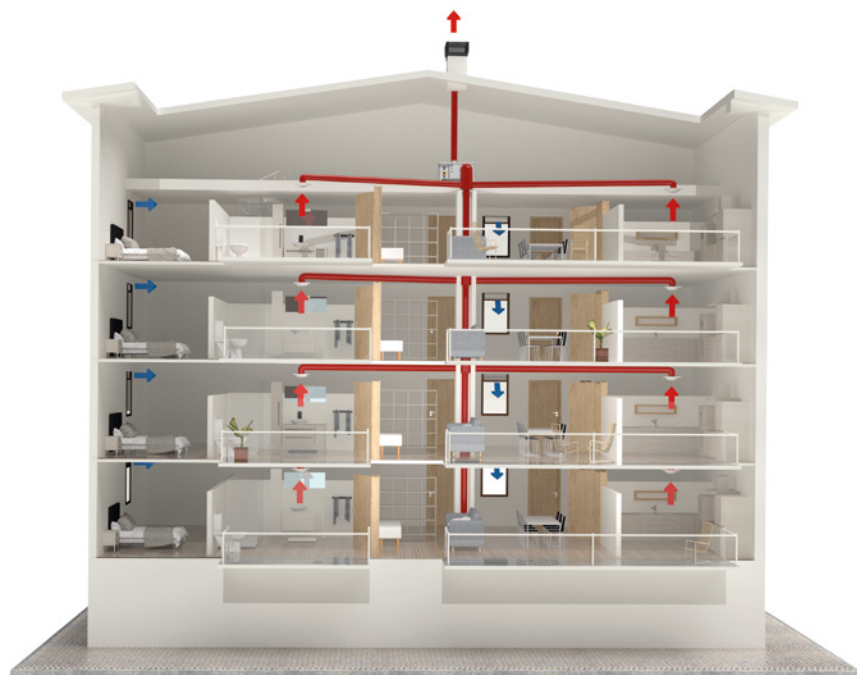

↑ EXTRACTION

The following models can be used for extraction, taking into account that the CJV/EW/T model also has the F-400 certification for work at 400 °C/2 h, making it suitable for extracting smoke in the event of a fire in the home: SVE/PLUS/EW/CPC - CJBD/EC/CPC - CJV/EW - CRF/EW/CPC.

SODECA SOLUTIONS



CRF/EW/CPC

COLLECTIVE residential ventilation DOUBLE FLOW WITH HEAT RECOVERY



Collective residential ventilation with heat recovery system is an efficient solution for recovering heat from the air extracted from wet rooms and using it to control the temperature of the air that enters dry rooms. This reduces energy consumption and improves indoor air quality, preventing the growth

of mould and mildew. In short, it is a sustainable and beneficial solution for the health and comfort of occupants. A double flow CMV recovers a high percentage of energy in dwellings using a community heat recovery unit.



Efficient, sustainable and beneficial for people's comfort and economic savings

Benefits



Improves indoor air quality



Energy saving of up to 95% thanks to SODECA's efficient technologies



Reduces the environmental impact of the home

COLLECTIVE residential ventilation
DOUBLE FLOW WITH HEAT RECOVERY

Systems with controlled mechanical ventilation filter the outside air in order to retain pollen, fine particles and bacteria, while the inside air is extracted to release CO₂, humidity and volatile organic compounds (VOCs).

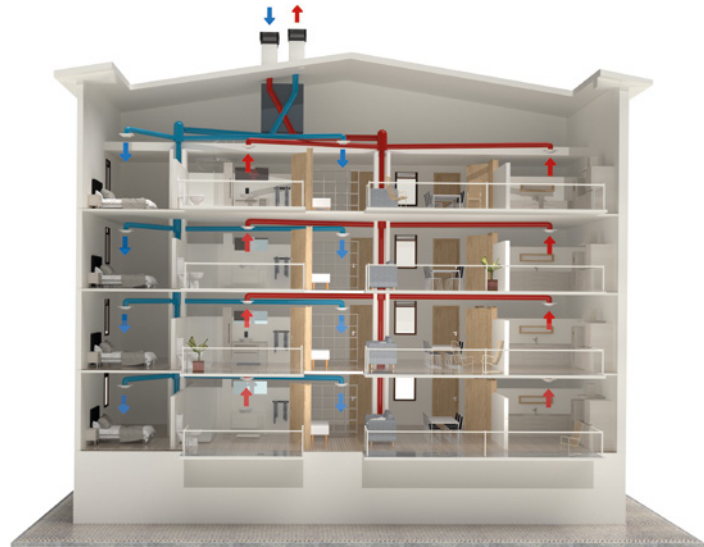

ENERGY SAVINGS

In the past, homes suffered from air infiltration due to their low airtightness, resulting in significant energy losses. However, homes nowadays are characterised by their high level of airtightness causing poor ventilation and increasing

condensation risk. For this reason it is vital to have Controlled Mechanical Ventilation (CMV) systems. Opting for this type of technology not only improves energy efficiency, but also helps to reduce energy costs.

SODECA's heat recovery units play a key role by ventilating, filtering and disinfecting air in indoor spaces. They also help recover a significant part of the energy, resulting in additional benefits to improve the energy efficiency of the home.

SODECA SOLUTIONS



REB



RECUP/EC BS



RECUP/ECH

PRESSURISATION SOLUTIONS FOR STAIRCASES, LOBBIES AND EVACUATION ROUTES IN THE EVENT OF FIRE



Pressurisation control systems protect evacuation routes in the event of fire, preventing the entry of smoke through air overpressure. If the doors are opened or in the event of air leaks, the system reacts

by increasing the flow rate. This guarantees that the escape routes are always free of smoke in an emergency situation.

Functions of the pressurisation system for evacuation routes



Equipped with all the components required for proper operation in accordance with standard EN 12101-6 (fan, pressure sensor, hatch, speed controller, PLC, etc.)



Allows **automatic controlling** the flow when the door is open (speed criteria) and maintain a minimum differential pressure (50 Pa) in cases where the door is closed **in accordance with the requirements set out in European standard EN 12101-6.**



They are supplied **integrated and ready for operation** (Plug&Play system).



The system incorporates an **activation in safe mode when a fire alarm signal is activated** and safe mode of operation when the doors are open due to an overpressure condition.



The **control panel** has status indicator lights and **an automatic or manual system power selector.**



It is **connected to the Building Management System (BMS)** or SCADA and may get the status of all the equipment via a remote connection depending on the model. Also, **a remote communications panel may be added for use by the fire department or other users.**



A motorised hatch and smoke detector may be used to manage air intake.

Inlet
of outside air

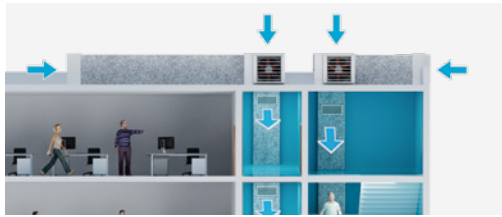

Pressurisation
air exhaust

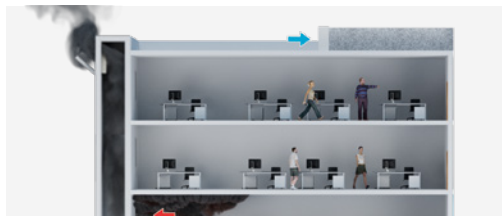

Pressurisation of
lobbies.
Joint
pressurisation
of all lobbies

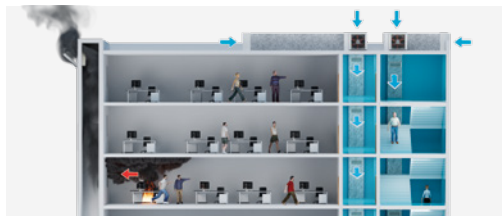

Pressurisation
of lobbies.
Individual
pressurisation
of lobbies

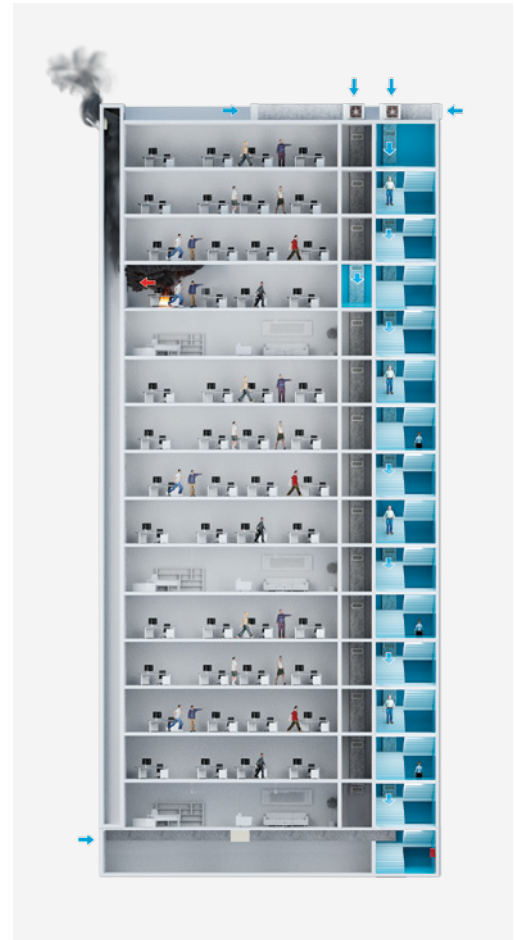
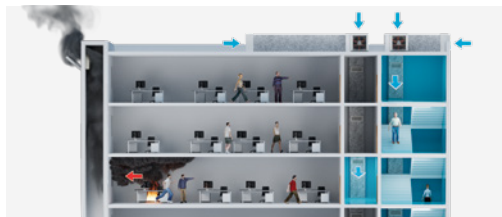

High-rise buildings

SODECA SOLUTIONS

Full range



HATCH PDS



KIT BOXPDS
KIT BOXPDS SMART



KIT BOXSMART
KIT BOXSMART II



KIT BOXSMART FLAP



KIT BOXPRES PLUS
KIT BOXPRES PLUS II



KIT SOBREPRESIÓN



PDS LOBBY CONTROL



KIT BOXSMART EC

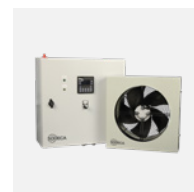

PRESSKIT

Advanced

Basic

VENTILATION SOLUTIONS FOR CAR PARKS



It is essential for the ventilation system for car parks to be **reliable throughout the years to ensure it is safe for users**. In car parks, ventilation may be natural or forced. In the latter, **fans must be**

installed to properly move the air and maintain the required conditions of safety and comfort under normal conditions as well as in the event of a fire.

Functions of ventilation for car parks



Equipped with all the components required for proper operation, in accordance with CTE DB SI and DB HS, and standard UNE 100166 depending on each application.

Car park ventilation systems are installed to carry out three functions:



Control smoke in the event of a fire, to help occupants evacuate as well as help fire fighters extinguish the fire.



Maintain the **concentration of contaminating gases** emitted by vehicles under control.



Maintain the **concentration of explosive gases** generated by possible vehicle fuel leaks under control.

These three functions are integrated in a single system that is capable of providing a flow adapted to the needs at any given time with the aim of optimising the system's power consumption.

Mechanical ventilation
through duct systems

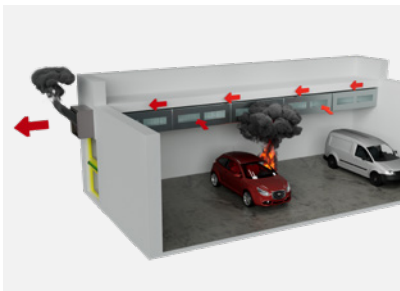

Mechanical ventilation
assisted by impulse ventilation

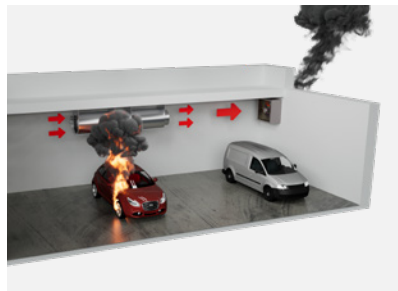

Natural ventilation
assisted by impulse ventilation

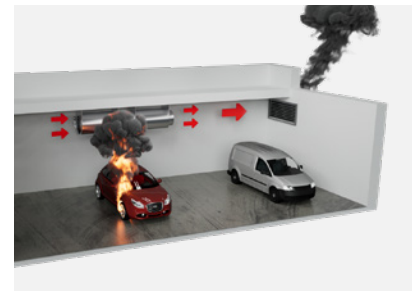

SODECA SOLUTIONS



IMMERSED

Installation of fan for immersed operation in fire risk zone

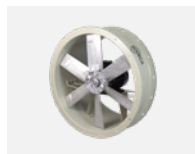

THT



CJTHT/PLUS



CJTHT/ATEX



THT/HATCH



CJBDT



CBDT



TCR



THT/WALL-F



CJS



CJMD



OUTDOOR

Installation of outdoor fans in fire risk zones



TCR/R



CJTCR/R



TCMP



CJMP



CJTX-C



CJSX



CJSRX



CJLINE



JET FAN

Installation of jet fan in the fire risk zone



THT/IMP-O



THT/IMP-L



CI

OTHER SOLUTIONS

In-line duct fans



SV
Low-noise, in-line duct extract fans mounted inside an acoustic casing.



SV/FILTER
Low-noise, in-line duct fans with different filtering stages.



TIRACANO
Chimney smoke extract fans.



EDD
Household extract fans with a modern appearance and design.

Roof-mounted extract fans



CTD
Centrifugal roof-mounted extract fans for household ventilation.



RCH
Chimney extract fan and cap for hybrid extraction in community housing.



NEOLINEO
In-line duct extract fans with a detachable body and small size and long-life ball bearings.

Bathroom extract fans



EDMF
Extra-flat bathroom extract fans with a modern appearance and design.



EDQUIET/S
Low-consumption household extract fans with very low noise levels.



CL/PLUS/EC
In-line duct fans for rectangular ducts with a 40 mm thick acoustic casing to reduce noise and EC Technology motor.

OVERPRESSURE CALCULATION IN STAIRCASES AREAS



Make it easy with **QuickFan!**

**QUICKFAN, THE SOFTWARE USED FOR
MAKING CALCULATIONS AND DESIGNING
VENTILATION PROJECTS**

TOOLS FOR ENGINEERING FIRMS
AND TECHNICAL DEPARTMENTS

Available in:



QUICKFAN

SODECA  SELECTOR

**Selecting the most suitable product for your
ventilation installation is now easier than ever**

Through the projects module for QuickFan and by downloading the designs in CAD 3D or REVIT, you can design ventilation projects, make calculations and obtain full technical reports in just a few minutes



Easy search



Personalise
reports



Always
updated



Reports in
minutes





HEADQUARTER

Sodeca, S.L.U.

Pol. Ind. La Barricona
Carrer del Metall, 2
E-17500 Ripoll
Girona, SPAIN
Tel. +34 93 852 91 11
General sales:
comercial@sodeca.com
Export sales:
ventilation@sodeca.com

PRODUCTION PLANT

Sodeca, S.L.U.

Ctra. de Berga, km 0,7
E-08580 Sant Quirze de Besora
Barcelona, SPAIN
Tel. +34 93 852 91 11
General sales:
comercial@sodeca.com
Export sales:
ventilation@sodeca.com

RED COMERCIAL ESPAÑA

Barcelona

Sr. Jesús Cuadras
Pol. Ind. La Barricona
Carrer del Metall, 2
E-17500 Ripoll
Girona, SPAIN
Tel. +34 93 852 91 11
Móvil: 639 077 346
jcuadras@sodeca.com
Provincias: Barcelona,
Tarragona, Lleida y Girona

Baleares

Sr. Miquel Àngel Morán
Móvil: 682 912 100
baleares@sodeca.com
Provincias: Baleares

Bilbao

Pitalven S.L.
Sr. Jon Garin
Pza. Jaro de Arana, 3 4º
48012 Bilbao
Tel. 94 421 42 23
Móvil: 615 749 646
jgarin@sodeca.com
Provincias: Vizcaya,
Guipúzcoa, Álava, Santander,
Navarra y Rioja

Canarias

Srta. Ana Terrones
Móvil: 676 340 543
canarias@sodeca.com
Provincias: Islas Canarias

A Coruña

Sr. Ricard Fernández
Rua a Granxa, 2B (Lorbe)
15177 Oleiros
Tel. 98 162 81 96
Móvil: 615 145 104
rfernandez@sodeca.com
Provincias: A Coruña, Lugo,
Ourense y Pontevedra

Gijón

Sr. Iván Herrera
Móvil: 689 804 734
asturias@sodeca.com
Provincias: Asturias y León

Madrid

Sr. José María de Bernardo
Pol.Ind. Miralcampo
Calle Aluminio, 12
19200 Azuqueca de Henares
Tel. 91 366 70 45
91 366 60 45
Móvil: 670 744 420
sodecacentro@sodeca.com
Provincias: Madrid, Toledo,
Ciudad Real, Guadalajara,
Segovia, Ávila y Cuenca

Murcia

Sr. Francisco José Hurtado
Apartado de Correos 6103
30080 Murcia
Móvil: 675 767 025
hurtado@sodeca.com
Provincias: Murcia, Almería,
Granada y Jaén

Sevilla

Sr. Manuel Zambrano
Pol.Ind. Los Llanos
Calle Extremadura, 169 F
41909 Salteras
Sevilla
Móvil: 606 663 814
mzambrano@sodeca.com
sevilla@sodeca.com
Provincias: Sevilla, Huelva,
Cádiz, Córdoba, Málaga,
Cáceres y Badajoz

Valencia

Tacifer S.L.
Sr. Javier Talens
Timoneda, 8, 1º
46008 Valencia
Tel. 96 384 14 80
Móvil: 670 696 289
javiertalens@sodeca.com
csebastian@sodeca.com
Provincias: Valencia, Castellón,
Alicante y Albacete

Valladolid

Sr. Xavier Formentí
Móvil: 679 559 099
sodecacastilla@sodeca.com
Provincias: Salamanca,
Valladolid, Palencia, Burgos y
Zamora

Zaragoza

Hernández Silbe S.L.
Srta. Silvia Hernández
Alfonso I, casa 15
50410 Cuarte de Huerva
Zaragoza
Móvil: 630 263 224
sodecaragon@sodeca.com
Provincias: Huesca, Zaragoza,
Teruel y Soria



EUROPE

FINLAND

Sodeca Finland, Oy

HUITTINEN
Sales and Warehouse
Mr. Kai Yli-Sipilä
Metsälinnankatu 26
FI-32700 Huittinen
Tel. + 358 400 320 125
orders.finland@sodeca.com

FINLAND

Sodeca Finland, Oy

VANTAA
Sales and Warehouse
Ainontie 12
FI-01630 Vantaa

Smoke Extraction

Mr. Antti Kontkanen
Tel. +358 400 237 434
akontkanen@sodeca.com
Mrs. Kaisa Partanen
Tel. +358 451 308 038
kpartanen@sodeca.com

Industrial Applications

Mr. Jarno Pikkumäki
Tel. +358 407 723 472
jpikkumaki@sodeca.com

ITALIA

Sodeca Italia

Viale del Lavoro, 28
37036 San Martino B.A.
(VR), ITALY
Tel. +39 045 87 80 140
vendite@sodeca.com

NORWAY

Sodeca Norge AS

Per Krohgs vei 4C
1065 Oslo
NORWAY
Tel. +47 23 28 80 90
post@sodeca.no

PORTUGAL

Sodeca Portugal, Unip. Lda.

PORTO
Rua Veloso Salgado 1120/1138
4450-801 Leça de Palmeira
Tel. +351 229 991 100
geral@sodeca.pt

LISBOA

Pq. Emp. da Granja Pav. 29
2625-607 Vialonga
Tel. +351 219 748 491
geral@sodeca.pt

ALGARVE

Rua da Alegria, 33
8200-569 Ferreiras
Tel. +351 289 092 586
geral@sodeca.pt

UNITED KINGDOM

Sodeca Fans UK, Ltd.

Mr. Mark Newcombe
Tamworth Enterprise Centre
Philip Dix House, Corporation
Street, Tamworth, B79 7DN
UNITED KINGDOM
Tel. +44 (0) 1827 216 109
sales@sodeca.co.uk

AMERICA

CHILE

Sodeca Ventiladores, SpA.

Sra. Sofia Ormazábal
Santa Bernardita 12.005
(Esquina con Puerta Sur)
Bodegas b24 a b26,
San Bernardo, Santiago, CHILE
Tel. +56 22 840 5582
ventas.chile@sodeca.com

COLOMBIA

Sodeca Latam, S.A.S.

Sra. Luisa Stella Prieto
Calle7 No. 13 A-44
Manzana 4 Lote 1, Montana
Mosquera, Cundinamarca
Bogotá, COLOMBIA
Tel. +57 1 756 4213
ventascolombia@sodeca.co

PERU

Sodeca Perú, S.A.C.

Sr. Jose Luis Jiménez
C/ Mariscal Jose Luis de
Orbegoso 331. Urb. El pino.
15022, San Luis. Lima, PERÚ
Tel. +51 1 326 24 24
Cel. +51 994671594
comercial@sodeca.pe

VENTILATION SOLUTIONS FOR HOMES



HEADQUARTER

Sodeca, S.L.U.

Pol. Ind. La Barricona
Carrer del Metall, 2
E-17500 Ripoll
Girona, SPAIN
Tel. +34 93 852 91 11
General sales: comercial@sodeca.com
Export sales: ventilation@sodeca.com

PRODUCTION PLANT

Sodeca, S.L.U.

Ctra. de Berga, km 0,7
E-08580 Sant Quirze de Besora
Barcelona, SPAIN
Tel. +34 93 852 91 11
General sales: comercial@sodeca.com
Export sales: ventilation@sodeca.com

