



# 60 Hz

## GENERAL CATALOGUE



### HEAD OFFICE

Ctra. de Berga, km 0,7  
E-08580 SANT QUIRZE DE BESORA  
Barcelona - SPAIN  
Tel. +34 93 852 91 11  
Fax +34 93 852 90 42  
General sales: [comercial@sodeca.com](mailto:comercial@sodeca.com)  
Export sales: [ventilation@sodeca.com](mailto:ventilation@sodeca.com)





## OUR COMMITMENT TO THE ENVIRONMENT

Sodeca has begun a new stage of study and design of new trends in ventilation which will help to preserve the environment and to make the energy saving which so much concerns today's society.



### EFFICIENT WORK

SODECA is pleased to present its new efficient, high performance "Efficient Work" fans, equipped with high-tech motors for greater energy savings. These new products exceed the requirements of the Ecodesign ErP Directive of 2009/125/CE and the (EU) regulation 327/2011 governing fans and adhere to the KYOTO goals adopted by the EU for cutting greenhouse gas emissions.

**SODECA** focuses its business activity on the manufacture of industrial fans, ventilation systems and smoke extractor fans for fire protection since it was set up in 1983.

The fans and extractor fans manufactured by **SODECA** are present in Europe and in many other parts of the world due to their quality and the research and development methods used.

Our quality procedures, certified by BUREAU VERITAS in accordance with ISO 9001:2015, are another reason why **SODECA** is positioned as one of the best and most recognised fan manufacturer in Europe.

There is no doubt that the most important element in achieving our objectives is the human factor and the professionals who work in the company and offer not only ventilation equipment but solutions to all the needs of our customers in the ventilation sector.

We offer them the option of visiting our facilities in Sant Quirze de Besora, with a developed surface area of more than 16,000 m<sup>2</sup>, to see our fan production plant, which complies with the highest quality requirements and with the ISO and AMCA standards.

This catalogue contains just a few of all the options we offer. Please contact us and we will place all our experience and staff at your disposal.



SODECA S.L.U. main facilities in E-08580 SANT QUIRZE DE BESORA



# INDUSTRIAL FANS AND EXTRACTOR UNITS

Since it was first established, Sodeca has specialised in the design and manufacture of fans and their accessories for industrial applications.

The combination of its experience gained over decades of working with fans and the technology provided by the engineers employed in its different departments has allowed Sodeca to occupy a leading international position as a fan manufacturer.

Industrial applications require an important capacity to adapt to the specifications of each project and flexibility in production in order to comply with the real needs of each client.

To comply with this objective, Sodeca has a standard products line and a specially-manufactured products line for building fans that meet the demands of our clients.

For many years, we have constantly invested in the development of processes and applications aimed at manufacturing and supplying special industrial fans with extremely tight deadlines in terms of their design and production.

The teamwork of our engineering department, in conjunction with universities and technological centres, and the close cooperation between the design departments of our external partners has made it possible to obtain new industrial fan solutions in a very short space of time.

During our history, we have developed all manner of fan technology for industrial applications in all parts of the world. Our aim is to continue to invest in this sector in order to become one of the most reputed global industrial fan manufacturers.



**IN-LINE DUCT EXTRACTOR FANS**

12

<b>SVE</b>	<b>SVE/PLUS</b>	<b>NEOLINEO/V</b>	<b>NEOSILENT</b>	<b>EDMF</b>
 <p>In-line duct extractor fans</p> <p style="text-align: right;">13</p>	 <p>In-line duct extractor fans with 40-mm acoustic insulation</p> <p style="text-align: right;">13</p>	 <p>Small, in-line duct extractor fans with a detachable body</p> <p style="text-align: right;">19</p>	 <p>In-line duct extractor fans</p> <p style="text-align: right;">21</p>	 <p>Extra-flat bathroom extractor fans with a modern appearance and design</p> <p style="text-align: right;">24</p>

**AXIAL EXTRACTOR FANS**

26

<b>HC</b>	<b>HGI</b>	<b>HCD</b>	<b>HCH</b>	<b>HCT</b>
 <p>Wall-mounted axial fans with IP55 motors</p> <p style="text-align: right;">27</p>	 <p>Axial fans with large diameters</p> <p style="text-align: right;">33</p>	 <p>Wall-mounted axial fans with small diameters</p> <p style="text-align: right;">35</p>	 <p>Extremely robust wall-mounted, tubular, axial fans</p> <p style="text-align: right;">37</p>	 <p>Extremely robust wall-mounted, tubular, axial fans</p> <p style="text-align: right;">37</p>
<b>CJHCH</b>	<b>HCT/IMP-C</b>	<b>HCT/IMP</b>	<b>HFW</b>	<b>HTP</b>
 <p>Axial ventilation units with acoustically-isolated box</p> <p style="text-align: right;">49</p>	 <p>Long-range, circular, one-way or reversible jet fans</p> <p style="text-align: right;">52</p>	 <p>Long-range one-way or reversible jet fans</p> <p style="text-align: right;">54</p>	 <p>Hot dip galvanised tubular fans</p> <p style="text-align: right;">57</p>	 <p>High pressure tubular axial extractor fans</p> <p style="text-align: right;">62</p>
<b>HGT HGTX</b>	<b>HPX</b>	<b>HBA</b>		
 <p>Tubular axial fans with large diameters and direct drive motors.</p> <p style="text-align: right;">75</p>	 <p>Tubular axial fans with external motors</p> <p style="text-align: right;">102</p>	 <p>Forked tubular axial fans</p> <p style="text-align: right;">105</p>		

## CENTRIFUGAL EXTRACTOR FANS

107

## CI-CO



Long-range, low profile, centrifugal induction jet fans

110

## CMX



VENT-SET belt-driven centrifugal extractor fans fitted with reaction impeller

111

## CBD

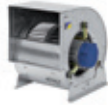

Low-pressure, double inlet, centrifugal fans with direct-drive motors

120

## CJBD/ALG



Ventilation units made of aluminium profiles and galvanised sheet steel with acoustic insulation

123

## CBX



Centrifugal, double inlet, belt-driven fans

126

## CBXC



Centrifugal, double inlet, belt-driven fans

126

## CBXR



Centrifugal, double inlet, belt-driven fans

126

## CBXT



Centrifugal, double inlet, belt-driven fans

126

## CJBX/ALG



Belt-driven ventilation units made of aluminium profiles and galvanised sheet steel with acoustic insulation

136

## CDXR



Double inlet, belt-driven fans

144

## CDXRT



Double inlet, belt-driven fans

144

## CJDXR



Double inlet, belt-driven ventilation units

144

## CSXR



Single inlet, belt-driven fans

153

## CSXRT



Single inlet, belt-driven fans

153

## CJSXR



Single inlet, belt-driven ventilation units a transmission

153

## TSA



Single inlet, belt-driven fans

165

## TSAT



Single inlet, belt-driven fans

165

## CJTSA



Single inlet, belt-driven ventilation units

165

## CJBR



Soundproof ventilation units with sandwich-panel and linear airflow between the inlet and outlet.

173

## CMP



Medium pressure, centrifugal fans fitted with sheet steel or aluminium impeller

175

## CMR



Extremely robust, medium pressure, centrifugal fans

183

## CMA



Medium pressure, centrifugal fans with cast aluminium impeller

188

## CPV



Centrifugal fans made of anti-corrosive plastic material

191

## CA



High pressure centrifugal fans made of cast aluminium

196

## CAS



High pressure centrifugal fans made of sheet steel

199

## CAS-S









High pressure, centrifugal fans made of sheet steel with acoustic attenuators

199

**ROOF-MOUNTED EXTRACTOR FANS**

205











<p><b>VC-HDU</b></p>  <p>Centrifugal roof-mounted extractor fans, with vertical air outlet</p> <p>208</p>	<p><b>CXT</b></p>  <p>Roof-mounted, belt-driven centrifugal fans with a vertical or horizontal air impulsion design</p> <p>217</p>	<p><b>RFH</b></p>  <p>400 °C/2h centrifugal roof-mounted extractor fans, with horizontal air outlet</p> <p>222</p>	<p><b>RFV</b></p>  <p>400 °C/2h centrifugal roof-mounted extractor fans, with vertical air outlet</p> <p>222</p>	<p><b>CRF</b></p>  <p>Roof-mounted centrifugal extractor fans, with low noise level</p> <p>227</p>
<p><b>HT</b></p>  <p>Roof-mounted axial extractor fans with flat bases</p> <p>230</p>	<p><b>HTMH</b></p>  <p>Roof-mounted multifunctional extractor fans for large flow rates</p> <p>233</p>	<p><b>HTMV</b></p>  <p>Roof-mounted axial extractor fans with vertical air outlet</p> <p>240</p>		

**F-300 AND F-400 EXTRACTOR FANS FOR SMOKE EVACUATION IN CAR PARKS AND SIMILAR**

F-400 CERTIFICATION



267

<p><b>THT</b></p>  <p>400 °C/2h and 300 °C/2h tubular axial extractor fans</p> <p>272</p>	<p><b>CJTHT</b></p>  <p>Axial fans 400°C/2h and 300°C/2h With sound-proofed box</p> <p>325</p>	<p><b>THT/IMP</b></p>  <p>300 °C/2h and 400 °C/2h long-range one-way or reversible jet fans with a circular or octagonal design</p> <p>331</p>	<p><b>CI</b></p>  <p>300 °C/2h and 400 °C/2h long range, induction centrifugal fans</p> <p>335</p>	<p><b>HTMF</b></p>  <p>400 °C/2h and 300 °C/2h roof-mounted multifunctional extractor fans</p> <p>336</p>
<p><b>THT/ROOF</b></p>  <p>400 °C/2h and 300 °C/2h roof-mounted axial extractor fans with vertical air outlet</p> <p>343</p>	<p><b>TCR/R</b></p>  <p>400 °C/2h centrifugal extractor fan with reaction impeller</p> <p>346</p>	<p><b>CJTCR/R</b></p>  <p>400 °C/2h extractor fan units with reaction impeller</p> <p>346</p>	<p><b>CJTX-C</b></p>  <p>400 °C/2h extractor fan units with motor and belt drive inside box</p> <p>351</p>	<p><b>CJSX</b></p>  <p>400 °C/2h belt-driven, single inlet extractor fan units</p> <p>359</p>
<p><b>CSX</b></p>  <p>400 °C/2h belt-driven centrifugal extractor fans with reaction impeller</p> <p>365</p>				

**STAIRCASE OVERPRESSURE KIT**

374

<p><b>KIT SOBREPRESIÓN</b></p>  <p>Pressurisation system for staircases, escape routes or confinement</p> <p>381</p>	<p><b>KIT BOXPDS</b></p>  <p>Pressurisation equipment for staircases, escape routes and fire fighting lobbies</p> <p>385</p>	<p><b>HATCH PDS</b></p>  <p>Pressurisation equipment for staircases, escape routes and fire fighting lobbies</p> <p>387</p>
---	---	--

ATEX CERTIFIED

**ATEX EXTRACTOR FANS FOR EXPLOSIVE ATMOSPHERES**



ERC



390

**HCDF**



Axial extractor fans with a square frame and ATEX Ex d certification

397

**HDF**



Axial fans with a circular frame and ATEX Ex d certification

397

**HCH/ATEX**



Extremely robust, wall-mounted axial extractor fans with ATEX certification

400

**HCT/ATEX**



Extremely robust, wall-mounted axial extractor fans with ATEX certification

400

**CMA/ATEX**



Medium pressure, centrifugal fans made of cast aluminium, with ATEX certification

404

**CMP/ATEX**



Wall-mounted medium pressure, centrifugal fans fitted with multi-blade impeller and with ATEX certification

406

**CMR/ATEX**



Extremely robust, medium pressure, centrifugal extractor fans fitted with reaction impeller and with ATEX certification

410

**HEAT RECOVERY UNITS • AIR FILTER AND TREATMENT UNITS**

413

**RECUP**



Configurable heat recovery units with cross-flow plates for horizontal (H) or vertical (V) installation

419

**SV/FILTER**



Low-noise, in-line duct extractor fans with different filtering phases.

423

**UFR**



Filter units acoustically insulated with sandwich panel

427

**UDT**



Ventilation units with air treatment systems and direct drive motors

431

**UDTX**



Belt-driven ventilation units with air treatment systems

437

**AIR CURTAINS**

445

**ECONOMIC**



Economical air curtains for small commercial establishments.

447



# NEW TOOL FOR ENGINEERING FIRMS AND TECHNICAL DEPARTMENTS

## PROJECT MODULE

### *Prepare technical reports in minutes*

- . Select hundreds of models in a single step
- . Mass load your data in Excel.
- . Edit and process the technical data sheets.
- . Print out the report with a contents table and cover, edit it or send it to another QuickFan.



Easy search



Personalise reports



Always updated



Reports in minutes



## OVERPRESSURE CALCULATION IN STAIRCASE AREAS

- . Rapid calculation of the necessary staircase over pressure flow rate for the most common systems, in accordance with UNE-EN 12101:2006.
- . Easily configure the design for each floor or for evacuation route areas.



## 3D CAD MODELS

- . Download our fans in 3D Cad from our website.
- . Choose from among more than 40 available Cad formats, including Revit.
- . More than 2,000 models and configurations available.

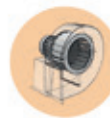

Models CAD 3D



Formats available



Always updated



Reports in minutes



Available in:





# COMPLIANCE WITH STANDARDS

**SODECA fans and extractors comply with the following standards:**

<b>QUALITY</b>	
<b>ISO 9001:2015</b>	Sistemas de gestión de la calidad. Requisitos. Quality management systems -- Requirements
<b>TRIALS</b>	
<b>UNE-EN ISO 5801</b>	Ventiladores industriales. Ensayos de comportamiento en circuitos normalizados. Industrial fans -- Performance testing using standardized airways
<b>AMCA 210-07</b>	Ventiladores industriales. Métodos de ensayos de ventiladores y su representación de ensayos. Laboratory Methods of Testing Fans for Aerodynamic Performance Rating
<b>UNE EN ISO 13350</b>	Ventiladores industriales. Ensayos de comportamiento de ventiladores de chorro. Industrial fans -- Performance testing of jet fans
<b>ISO 13348</b>	Industrial fans -- Tolerances, methods of conversion and technical data presentation
<b>HIGH TEMPERATURE FANS</b>	
<b>EN 12101-3</b>	Sistemas de control de humos y calor. Parte 3: Especificaciones para aireadores extractores de humos y calor mecánicos. Smoke and heat control systems - Part 3: Specification for powered smoke and heat exhaust ventilators
<b>ACOUSTICS</b>	
<b>EN ISO 3744</b>	Acústica. Determination of the acoustic power levels of noise sources based on acoustic pressure. Método de ingeniería para condiciones de campo libre sobre un plano reflectante. Acoustics -- Determination of sound power levels of noise sources using sound pressure. Engineering method in an essentially free field over a reflecting plane
<b>BALANCING AND VIBRATIONS</b>	
<b>ISO 1940-1</b>	Vibraciones mecánicas. Calidad de equilibrado Mechanical vibration -- Balance quality requirements for rotors in a constant (rigid) state -- Part 1: Specification and verification of balance tolerances
<b>ISO 10816-1</b>	Vibraciones mecánicas. Evaluación de las vibraciones de máquinas Mechanical vibration -- Evaluation of machine vibration by measurements on non-rotating parts -- Part 1: General guidelines
<b>ISO 14694</b>	Ventiladores industriales. Especificaciones para equilibrado y niveles de vibración Industrial fans -- Specifications for balance quality and vibration levels
<b>SAFETY (EC Declaration of Conformity)</b>	
<b>EN ISO 12100-1</b>	Seguridad de las máquinas. Conceptos básicos, principios generales para el diseño. Parte 1: Terminología básica, metodología. Safety of machinery -- Basic concepts, general principles for design -- Part 1: Basic terminology, methodology
<b>EN ISO 12100-2</b>	Seguridad de las máquinas. Conceptos básicos, principios generales para el diseño. Parte 2: Principios técnicos. Safety of machinery -- Basic concepts, general principles for design -- Part 2: Technical principles
<b>UNE EN 60204-1</b>	Seguridad de las máquinas. Equipo eléctrico de las máquinas. Parte 1: Requisitos generales. Safety of machinery - Electrical equipment of machines - Part 1: General requirements
<b>EN ISO 13857</b>	Seguridad de máquinas. Distancias de seguridad para impedir que se alcancen zonas peligrosas con los miembros superiores e inferiores. Safety of machinery -- Safety distances to prevent danger zones being reached by upper and lower limbs
<b>UNE EN ISO 12499</b>	Ventiladores industriales. Seguridad mecánica en los ventiladores Industrial fans -- Mechanical safety of fans -- Guarding
<b>DIRECTIVES AND REGULATIONS</b>	
<b>Directive 2006/42/CE</b>	Directiva de máquinas Machinery Directive
<b>Directive 2014/35/UE</b>	Directiva de baja tensión Low Voltage Directive
<b>Directive 2014/30/UE</b>	Directiva compatibilidad electromagnética EMC Directive
<b>Regulation 305/2011</b>	Directiva productos de construcción Construction Products Directive (CPR)
<b>Directive 2009/125/CE</b>	Directiva de requisitos de diseño ecológico para productos que utilizan energía. Ecodesign Requirements for Energy-related Products Directive
<b>AEX EXECUTIONS</b>	
<b>ATEX directive 2014/34/UE</b>	Aparatos y sistemas de protección para uso en atmósferas potencialmente explosivas Equipment and protective systems intended for use in potentially explosive atmospheres
<b>EN 14986</b>	Diseño de ventiladores para trabajar en atmósferas potencialmente explosivas. Design of fans working in potentially explosive atmospheres
<b>EN 13463-1</b>	Equipos no eléctricos destinados a atmósferas potencialmente explosivas. Parte 1: Requisitos y metodología básica. Non-electrical equipment for use in potentially explosive atmospheres - Part 1: Basic method and requirements
<b>EN 1127-1</b>	Explosive atmospheres. Prevención y protección contra la explosión. Parte 1: Conceptos básicos y metodología. Explosive atmospheres - Explosion prevention and protection - Part 1: Basic concepts and methodology

WORLD WIDE

**SODECA** Group

**350**

Staff  
Empleados  
Personnel  
Personal

**5**

Presence on 5 continents  
Presencia en 5 continentes  
Présence sur 5 continents  
Präsenz auf 5 Kontinenten

**5**

Production plants  
Plantas de producción  
Usines de production  
Fertigungsanlagen

**1**

European Centre for Research  
Centro europeo de Investigación  
Centre européen pour la recherche  
Europäisches Zentrum für die Forschung

**117**

Commercial presence in 117 countries  
Presencia comercial en 117 países  
La présence commerciale dans 117 pays  
Kommerzielle Präsenz in 117 Ländern

**7**

World Branches  
Filiales en el mundo  
Implantations mondiales  
Niederlassungen

**4200**

Products in catalogue  
Productos en catálogo  
Produits du catalogue  
Produkte im Katalog

**ISO 9001:2015**

Quality  
Calidad  
Qualité  
Qualität

**Erp 2015/2016/2018**



Efficiency  
Eficiencia  
Efficacité  
Leistungsfähigkeit

**AMCA 210-07**

Trials  
Ensayos  
Essais  
Studien

**EN-12101-3**



Trials temperature  
Ensayos temperatura  
Essais température  
Test Temperatur

**ISO 3744**

Acoustic  
Acustica  
Acoustique  
Akustisch

**ISO 1940-1**

Balanced  
Equilibrado  
Équilibré  
Ausgeglichen

**EN-ISO 12100**

Security  
Seguridad  
Sécurité  
Sicherheit

**Directive  
2009/125/EC**

Directives  
Directivas  
Directives  
Richtlinien

**EN-14986**

ATEX



5

Production plants

7

World Branches

117

Commercial presence  
in 117 countries

5

Continents

**SODECA** Group

HEAD OFFICE



Sodeca S.L.U.

Ctra. de Berga, km 0,7  
E-08580 SANT QUIRZE DE BESORA  
Barcelona, SPAIN  
Tel. +34 93 852 91 11  
Fax +34 93 852 90 42  
General sales: comercial@sodeca.com  
Export sales: ventilation@sodeca.com  
[www.sodeca.com](http://www.sodeca.com)



SUBSIDIARIES

**SODECA** Colombia

**COLOMBIA**  
**Sodeca Latam S.A.S**  
Sra. Luisa Stella Prieto  
Calle7 No. 13 A-44  
Manzana 4 Lote1  
Mosquera, Cundinamarca  
Bogotá, COLOMBIA  
Tel. +57 1 756 4213  
[ventascolombia@sodeca.co](mailto:ventascolombia@sodeca.co)

**SODECA** Chile

**CHILE**  
**Sodeca Ventiladores Ltda**  
Sr. Frederic Cousquer  
Santa Bernardita 12.005  
(Esquina con Puerta Sur)  
Bodegas 24 a 26,  
San Bernardo Santiago, CHILE  
Tel. +56 22 840 5582  
[ventas.chile@sodeca.com](mailto:ventas.chile@sodeca.com)

**ZONA CARIBE**  
**Sodeca Cuba**  
Residencial Miramar  
Apto. Nº 108, Ave. 7ma  
Nº 1805 entre 18 y 20,  
Miramar Playa, Havana, CUBA  
Tel. +537 20 43721  
[carlos@sodeca.co.cu](mailto:carlos@sodeca.co.cu)

**SODECA** Perú

**PERÚ**  
**Sodeca Perú SAC**  
Sr. Jose Luis Jimenez  
C/ Mariscal Jose Luis de  
Orbegoso 331. Urb. El pino.  
15022, San Luis. Lima, PERÚ  
Tel. +51 1 326 24 24  
Cel. +51 994671594  
[comercial@sodeca.pe](mailto:comercial@sodeca.pe)

**SODECA** Finland

**FINLAND**  
**Sodeca Finland Oy**  
Mr. Kai Yli-Sipilä  
Metsälinnankatu 30, PL2  
FI-32700 Huittinen  
FINLAND  
Tel. + 358 400 320 125  
[orders.finland@sodeca.com](mailto:orders.finland@sodeca.com)

**SODECA** Portugal

**PORTUGAL**  
**Sodeca Portugal**  
**Unipessoal Lda**  
PORTO  
Rua Veloso Salgado 120/1138  
4450-801 Leça de Palmeira  
Tel. +351 229 991 100  
Fax. +351 229 991 119  
[geral@sodeca.pt](mailto:geral@sodeca.pt)

**PORTUGAL**  
**Sodeca Portugal**  
**Unipessoal Lda**  
LISBOA  
Parque Empresarial da Granja  
Pavilhão 8, 2625-607 Vialonga  
Tel. +351 219 748 491  
Fax. +351 219 748 493  
[geral@sodeca.pt](mailto:geral@sodeca.pt)

**PORTUGAL**  
**Sodeca Portugal**  
**Unipessoal Lda**  
ALGARVE  
Rua da Alegria S/N  
8200-557 Cortesões  
Tel. +351 913 615 773  
[geral@sodeca.pt](mailto:geral@sodeca.pt)

**SODECA** Fans UK

**UNITED KINGDOM**  
**Sodeca Fans UK Ltd**  
Mr. Mark Newcombe  
Tamworth Enterprise Centre  
Philip Dix House  
Corporation Street  
Tamworth, B79 7DN  
UNITED KINGDOM  
Tel. +44 (0) 1827 264 435  
[sales@sodeca.co.uk](mailto:sales@sodeca.co.uk)

PRODUCTION  
PLANTS

**SODECA** Group  
Production plant

SANT QUIRZE DE BESORA  
Barcelona - SPAIN

**SODECA** Group  
Production plant

MADRID  
SPAIN

**SODECA** Group  
pideca

TORELLÓ  
Barcelona - SPAIN

**SODECA** Group  
Production plant

BOGOTÁ  
COLOMBIA

**SODECA** Group  
Production plant

SANTIAGO DE CHILE  
CHILE

**IN-LINE DUCT EXTRACTOR FANS**

12

**SVE**

In-line duct  
extractor fans

13

**SVE/PLUS**

In-line duct  
extractor fans  
with 40-mm  
acoustic  
insulation

13

**NEOLINEO/V**

Small, in-line  
duct extractor  
fans with a  
detachable  
body

19

**NEOSILENT**

In-line duct extractor fans

21

**EDMF**

Extra-flat  
bathroom  
extractor fans  
with a modern  
appearance  
and design

24

# SVE SVE/PLUS

**SVE: Low-noise, in-line duct extractor fans mounted inside an acoustic casing**

**SVE/PLUS: In-line, low noise duct fans mounted inside a 40 mm Phonoabsorbent acoustic casing**



Folding inspection cover, except models 100-125-150/L-160/L

**Fan:**

- Acoustic casing coated with phonoabsorbent material.
- Impeller with reaction blades except models 100-125-150-160-200/H, with multi-blade impeller.
- Standardised intake and impulsion flanges allowing for easy installation in ducts.
- Fitted with a folding inspection cover, except models 100-125-150/L-160/L.
- Support feet built into the box, for easy installation.
- Linear air flow direction.

**Motor:**

- External rotor motors with built-in thermal protector, class F, with ball bearings, IP54 protection.
- Adjustable, single-phase 220V 60Hz.
- Maximum temperature of air to be carried: +50 °C.

**Finish:**

- Anti-corrosive galvanised sheet steel.

OrdercodeSBuilt-in switch

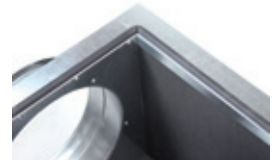

40 mm acoustic insulation model SVE/PLUS

**Order code**

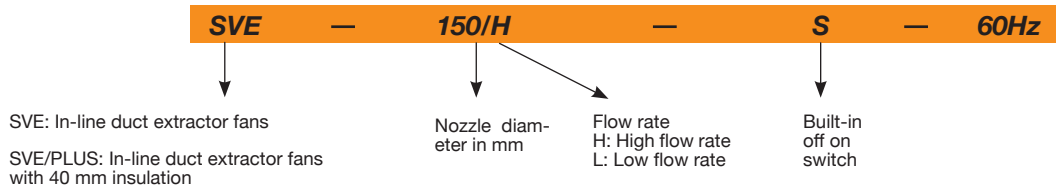

**Technical characteristics**

60Hz

Model	Speed (r/min)	Maximum admissible current 220V (A)	Max. electric power (kW)	Maximum flow rate (m³/h)	Irradiated sound level dB(A)	Approx. weight (kg)	Type of impeller
SVE-100/L	2160	0.45	0.10	290	44.10	5.5	Forward
SVE-125/H	2676	0.75	0.18	370	55.65	6.0	Forward
SVE-125/L	1800	0.45	0.10	310	45.15	5.5	Forward
SVE-150/H	2160	1.00	0.25	490	54.60	7.0	Forward
SVE-150/L	2160	0.45	0.10	355	54.60	6.0	Forward
SVE-160/H	2700	1.00	0.25	490	54.60	7.0	Forward
SVE-200/H	1680	0.75	0.18	760	44.10	12.0	Forward
SVE-200/L	3180	0.70	0.18	640	50.48	9.0	Backward
SVE-250/H	2880	0.75	0.18	1140	64.05	11.0	Backward
SVE-250/L	3300	0.75	0.17	705	55.65	9.5	Backward
SVE-315/H	1680	0.65	0.14	1315	48.30	17.5	Backward
SVE-350/H	1680	0.95	0.20	1555	46.20	21.5	Backward
SVE-400/H	1620	1.80	0.30	2310	48.30	27.0	Backward

### Technical characteristics

Model	Speed (r/min)	Maximum admissible current 220V (A)	Max. electric power (kW)	Maximum flow rate (m <sup>3</sup> /h)	Irradiated sound level dB(A)	Approx. weight (kg)	Type of impeller
SVE/PLUS-100/L	2160	0.45	0.10	290	28.35	9.0	Forward
SVE/PLUS-125/H	2808	0.75	0.18	370	39.90	9.5	Forward
SVE/PLUS-125/L	2160	0.45	0.10	310	29.40	9.0	Forward
SVE/PLUS-150/H	2700	1.00	0.25	490	37.80	12.0	Forward
SVE/PLUS-150/L	2160	0.45	0.10	355	27.30	9.5	Forward
SVE/PLUS-160/H	2700	1.00	0.25	490	37.80	12.0	Forward
SVE/PLUS-160/L	2160	0.45	0.10	355	27.30	9.5	Forward
SVE/PLUS-200/H	1680	0.75	0.18	760	39.90	16.5	Forward
SVE/PLUS-200/L	3180	0.70	0.18	640	38.85	13.5	Backward
SVE/PLUS-250/H	2880	0.75	0.18	1140	46.20	15.0	Backward
SVE/PLUS-250/L	3300	0.75	0.17	705	37.80	14.0	Backward
SVE/PLUS-315/H	1680	0.65	0.14	1315	43.05	23.0	Backward
SVE/PLUS-350/H	1680	0.85	0.20	1555	39.90	29.5	Backward
SVE/PLUS-400/H	1620	1.20	0.30	2310	43.05	33.0	Backward

### Acoustic characteristics

The values given are determined by measuring the sound power in dB(A) obtained in a free field at a distance equivalent to twice the size of the fan plus the impeller diameter, with a minimum of 1.5 m.

Sound power spectrum Lw(A) in dB(A) per Hz frequency band.

Model	63	125	250	500	1000	2000	4000	8000	Model	63	125	250	500	1000	2000	4000	8000
SVE-100/L	23	31	36	35	34	35	31	25	SVE/PLUS-100/L	20	31	34	30	25	29	27	24
SVE-125/H	23	33	37	35	34	35	31	25	SVE/PLUS-125/H	30	43	45	40	35	39	37	34
SVE-125/L	21	31	32	34	35	36	32	26	SVE/PLUS-125/L	20	33	35	30	25	29	27	24
SVE-150/H	33	43	47	45	44	45	41	35	SVE/PLUS-150/H	28	41	40	39	36	40	38	35
SVE-150/L	31	41	42	44	45	46	42	36	SVE/PLUS-150/L	18	31	30	29	26	30	28	25
SVE-160/H	31	41	42	44	45	46	42	36	SVE/PLUS-160/H	28	41	40	39	36	40	38	35
SVE-200/H	28	39	46	47	47	45	42	33	SVE/PLUS-160/L	18	31	30	29	26	30	28	25
SVE-200/L	29	40	47	48	48	46	43	34	SVE/PLUS-200/H	26	40	45	43	39	40	39	33
SVE-250/H	27	37	42	48	47	46	43	35	SVE/PLUS-200/L	25	39	44	42	38	39	38	32
SVE-250/L	35	45	50	56	55	54	51	43	SVE/PLUS-250/H	32	45	48	51	46	48	47	42
SVE-315/H	30	40	45	52	53	51	48	39	SVE/PLUS-250/L	24	37	40	43	38	40	39	34
SVE-350/H	29	39	43	50	51	49	47	38	SVE/PLUS-315/H	27	40	43	47	44	45	44	38
SVE-400/H	32	42	46	53	54	52	50	41	SVE/PLUS-350/H	26	39	41	45	42	43	43	37
									SVE/PLUS-400/H	29	42	44	48	45	46	46	40

### Dimensions mm

#### SVE

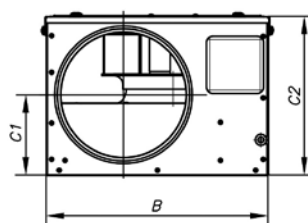
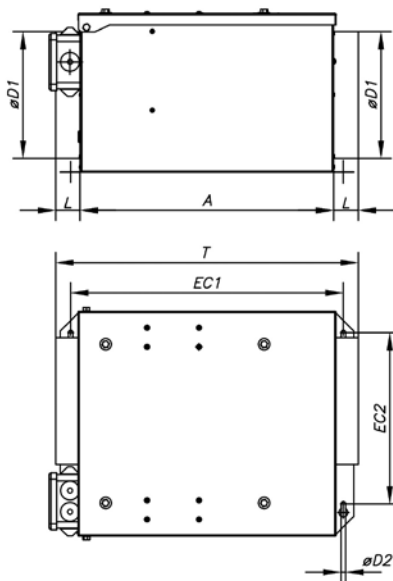

Model	A	B	C1	C2	øD1	L	øD2	EC1	EC2	T
SVE-100/L	300	265	82.5	180	100	36	7	330	205	372
SVE-125/L	300	265	80.5	180	125	36	7	330	205	372
SVE-125/H	300	265	80.5	180	125	36	7	330	205	372
SVE-150/L	300	265	88.5	180	150	40	7	330	205	380
SVE-150/H	300	260	100	195	150	40	7	330	190	380
SVE-160/H	300	260	100	195	160	40	7	330	190	380
SVE-200/L	400	350	127	250	200	40	7	430	270	480
SVE-200/H	400	350	127	250	200	40	7	430	270	480
SVE-250/L	400	350	142	290	250	48	7	430	280	496
SVE-250/H	400	350	142	290	250	48	7	430	280	496
SVE-315/H	515	480	175	355	315	48	7	545	405	610
SVE-350/H	575	545	211.5	410	350	58	7	605	445	690
SVE-400/H	650	610	230	455	400	74	7	680	520	800

Dimensions mm

SVE/PLUS

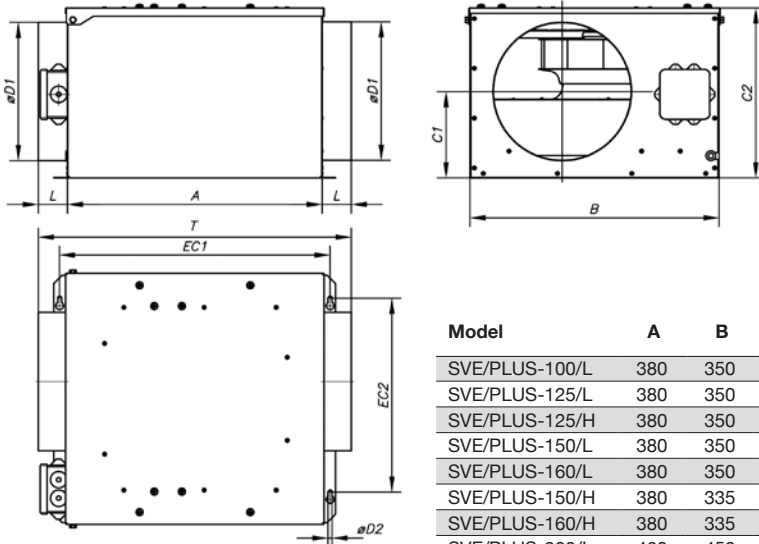

Model	A	B	C1	C2	øD1	L	øD2	EC1	EC2	T
SVE/PLUS-100/L	380	350	100	230	100	35	7	410	290	450
SVE/PLUS-125/L	380	350	100	230	125	35	7	410	290	450
SVE/PLUS-125/H	380	350	100	230	125	35	7	410	290	450
SVE/PLUS-150/L	380	350	110	230	150	35	7	410	290	450
SVE/PLUS-160/L	380	350	110	230	160	35	7	410	290	450
SVE/PLUS-150/H	380	335	165	265	150	37.5	7	405	265	455
SVE/PLUS-160/H	380	335	165	265	160	37.5	7	405	265	455
SVE/PLUS-200/L	460	450	162	285	200	37.5	7	490	380	535
SVE/PLUS-200/H	460	450	162	285	200	37.5	7	490	380	535
SVE/PLUS-250/L	460	450	156	310	250	52.5	7	490	380	565
SVE/PLUS-250/H	460	450	156	310	250	52.5	7	490	380	565
SVE/PLUS-315/H	565	540	210	390	315	57.5	9	595	440	680
SVE/PLUS-350/H	650	600	233.5	435	350	57.5	9	680	525	765
SVE/PLUS-400/H	650	680	263.5	500	400	77.5	9	680	600	805

Characteristic curves

Q= Flow rate in m<sup>3</sup>/h, m<sup>3</sup>/s and cfm

Pe= Static pressure in mmH<sub>2</sub>O, Pa and inwg.

SVE

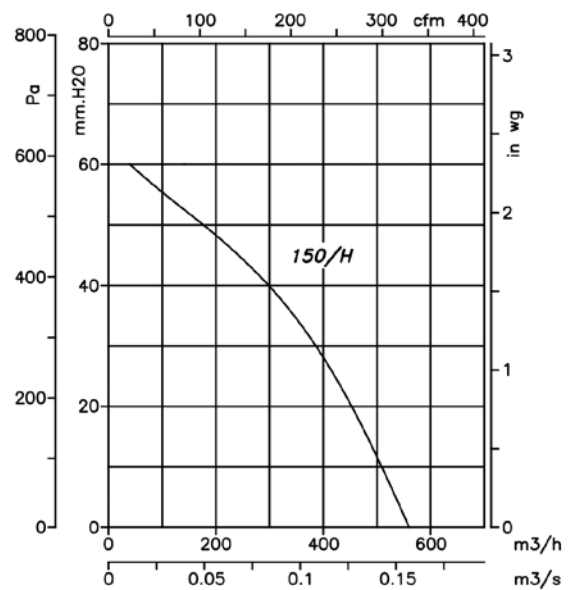
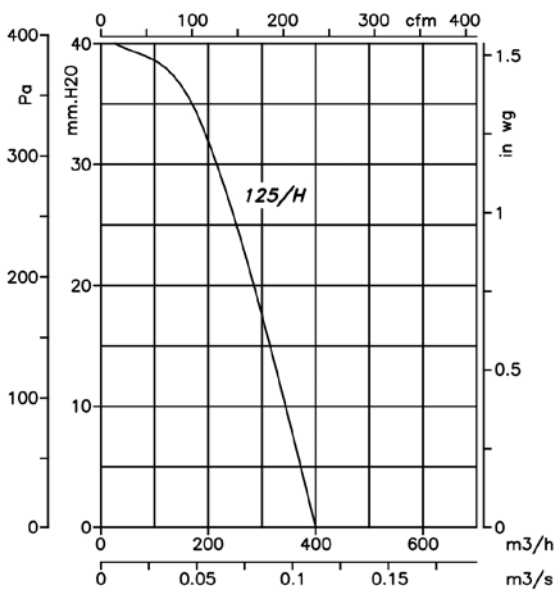

**Characteristic curves**

Q= Flow rate in m<sup>3</sup>/h, m<sup>3</sup>/s and cfm

Pe= Static pressure in mmH<sub>2</sub>O, Pa and inwg.

**SVE**

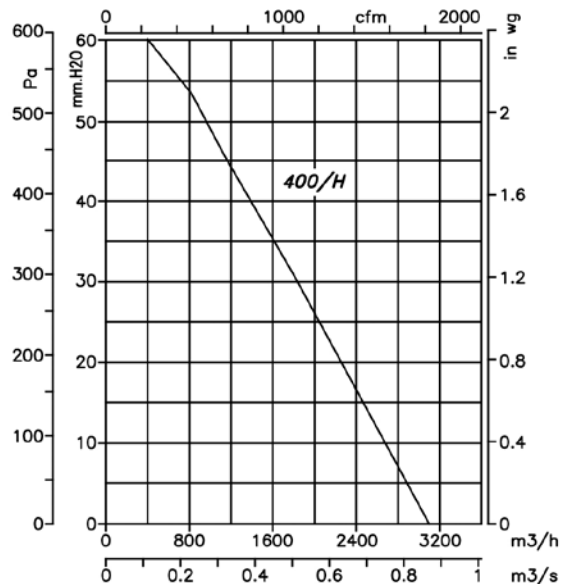
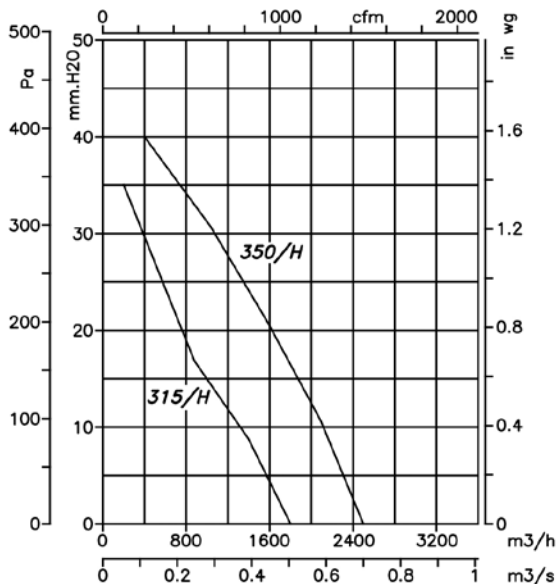
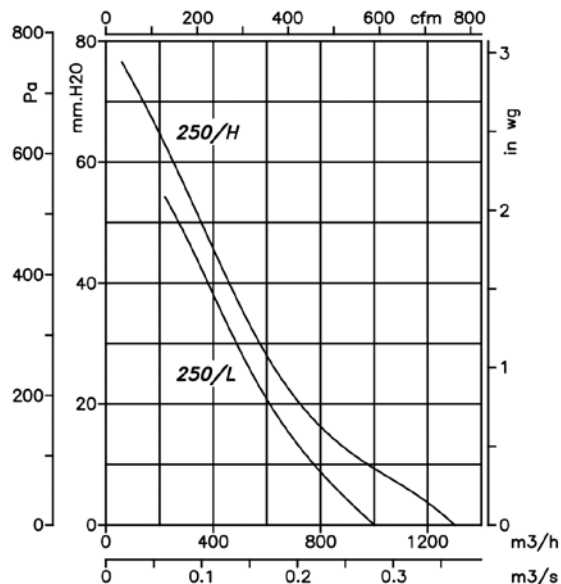
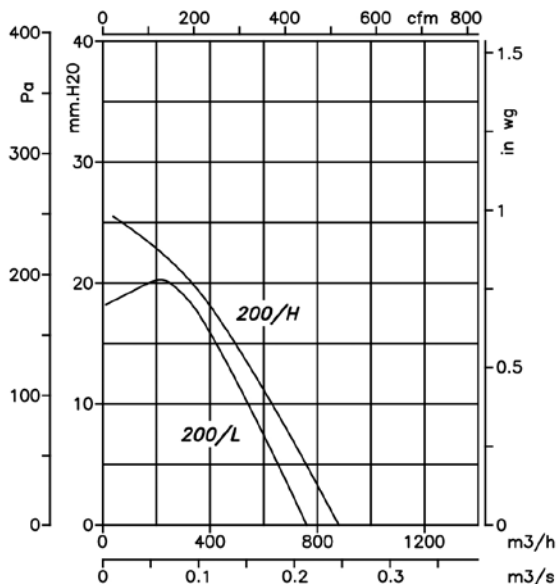



**Characteristic curves**

Q= Flow rate in m<sup>3</sup>/h, m<sup>3</sup>/s and cfm

Pe= Static pressure in mmH<sub>2</sub>O, Pa and inwg.

**SVE/PLUS**

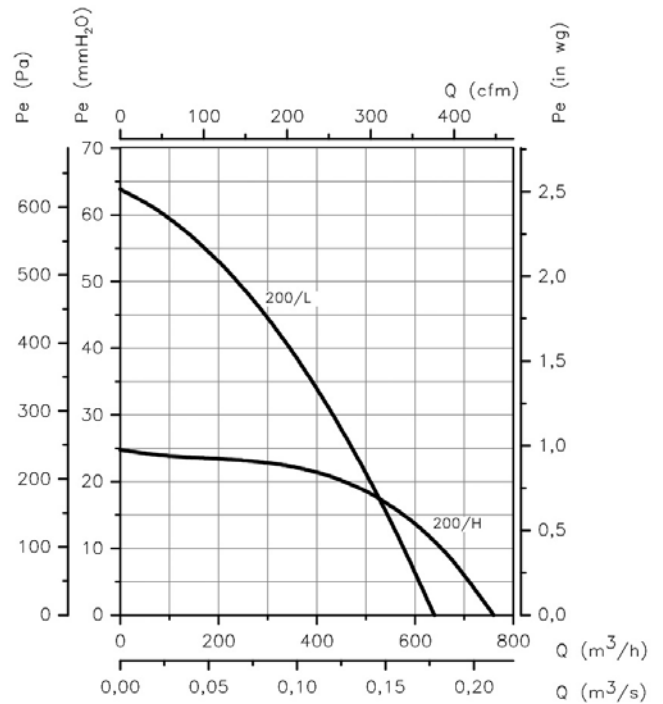
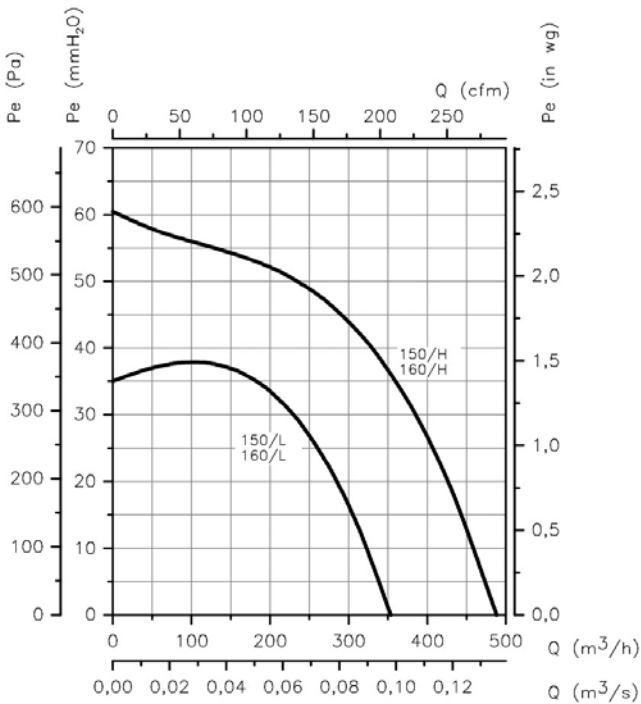
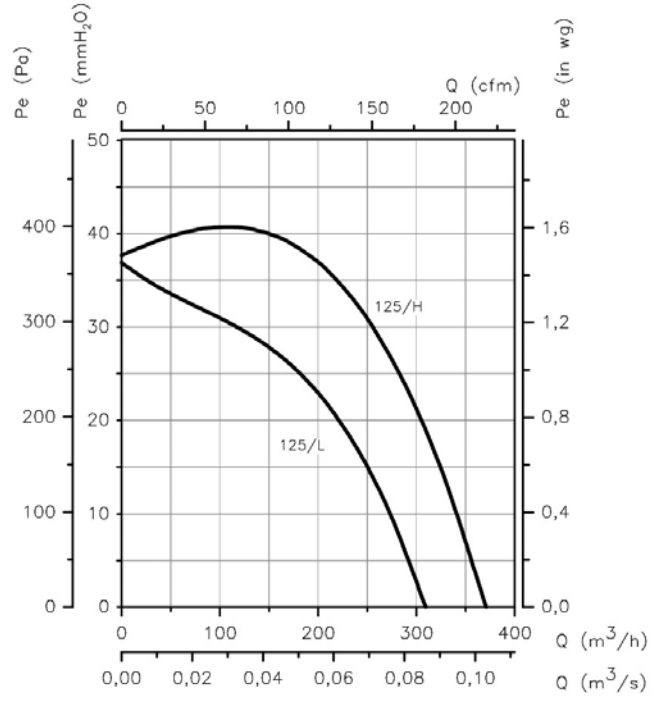
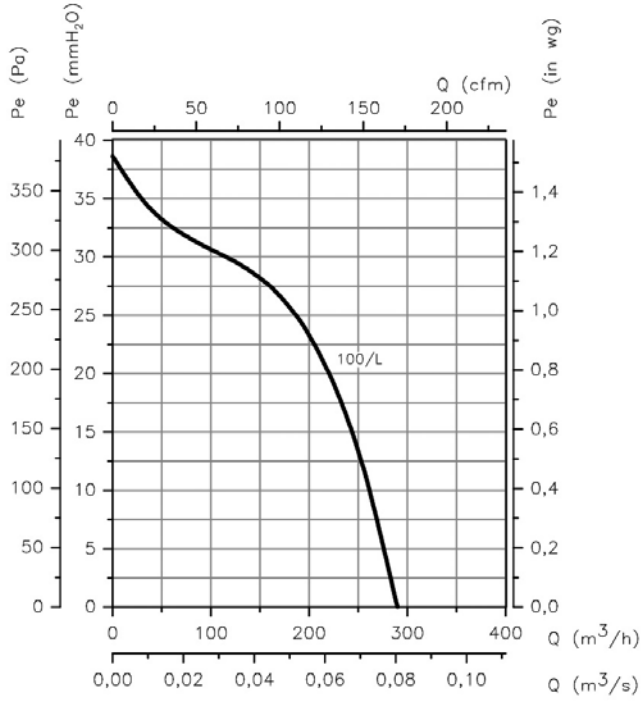

**Characteristic curves**

Q= Flow rate in m<sup>3</sup>/h, m<sup>3</sup>/s and cfm

Pe= Static pressure in mmH<sup>2</sup>O, Pa and inwg.

**SVE/PLUS**

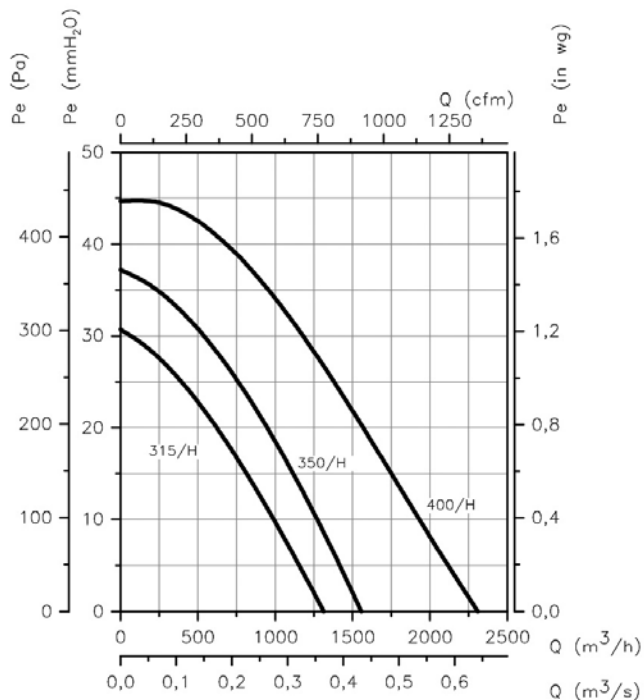
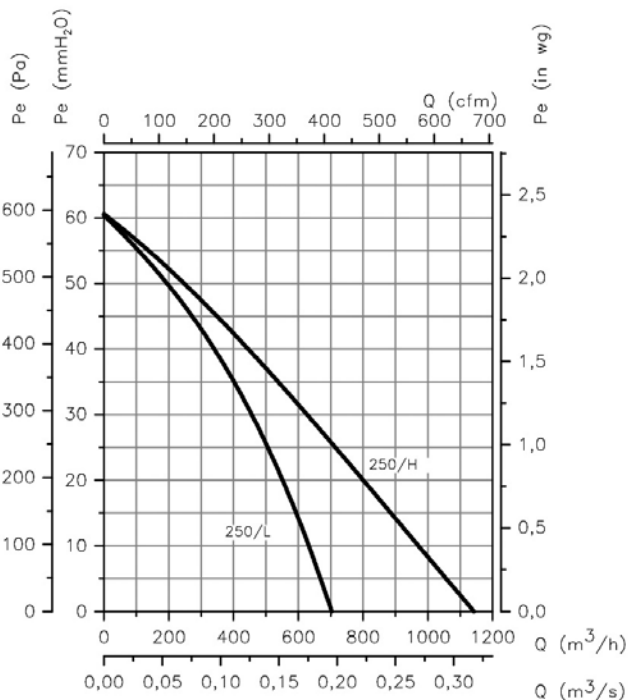

**Accessories**



# NEOLINEO/V

*In-line duct extractor fans with a detachable body and small size and durable ball bearings*



#### Fan:

- Casing made of self-extinguishing V0 plastic material
- External terminal box with variable position
- Easy, rapid installation

#### Motor:

- 2-speed, adjustable motors with durable ball bearings and IPX4 protection
- Single-phase 110/120V. 60Hz or 220V 60Hz
- Operating temperature -10 °C + 60 °C

#### Finish:

- Made of V0 white, plastic, self-extinguishing material

### Order code

<b>NEOLINEO/V</b>	—	<b>100</b>	—	<b>(Q)</b>	—	<b>(T)</b>	—	<b>1</b>	—	<b>60HZ</b>
↓		↓		↓		↓		↓		
NEOLINEO/V: In-line duct extractor fans with a detachable body		Nozzle diameter in mm		Q reference, low flow rate level		Reference T, with a built-in timer		1: 110V 60Hz power supply 2: 220V 60Hz power supply		

### Technical characteristics

**60Hz**

Model	Speed (r/min) min/max	Maximum admissible current (A) min/max	Max. electric power (kW) min/max	Max. flow rate (m <sup>3</sup> /h) min/max	Irradiated sound level* dB(A) min/max	Approx. weight (kg)
NEOLINEO 100/V	2180 / 2385	0,11 / 0,21	0,021 / 0,033	145 / 187	26 / 30	1,5
NEOLINEO 125/V	1950 / 2455	0,18 / 0,27	0,023 / 0,037	220 / 280	28 / 35	1,4
NEOLINEO 150/V	1680 / 2460	0,17 / 0,27	0,030 / 0,060	405 / 520	30 / 35	2,7
NEOLINEO 160/V	1680 / 2460	0,17 / 0,27	0,030 / 0,060	405 / 520	30 / 35	2,7
NEOLINEO 200/V	1915 / 2380	0,34 / 0,48	0,076 / 0,108	830 / 1040	32 / 38	4,0
NEOLINEO 250/V	1955 / 2440	0,54 / 0,79	0,125 / 0,177	1110 / 1400	45 / 55	7,8
NEOLINEO 315/V	1890 / 2430	1,00 / 1,42	0,230 / 0,320	1570 / 2050	49 / 58	11,9

\*Irradiated sound pressure levels obtained at a distance of 3 metres in a free field, with rigid intake/discharge tubes.

### Dimensions mm

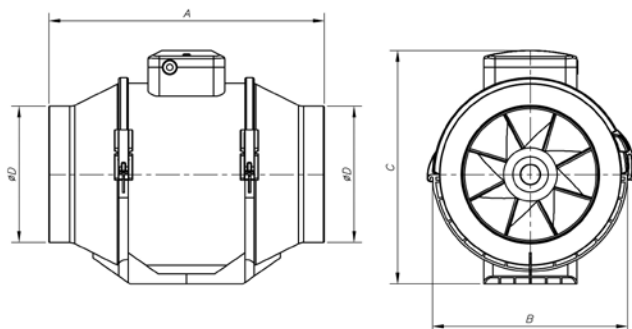

Model	A	B	C	øD
NEOLINEO 100/V	246	126	190	96
NEOLINEO 125/V	246	126	190	123
NEOLINEO 150/V	295	185	250	148
NEOLINEO 160/V	295	185	250	158
NEOLINEO 200/V	296	209	261	197
NEOLINEO 250/V	383	256	320	247
NEOLINEO 315/V	445	323	408	310

**Characteristic curves**

Q= Flow rate in m<sup>3</sup>/h      Pe= Static pressure in Pa

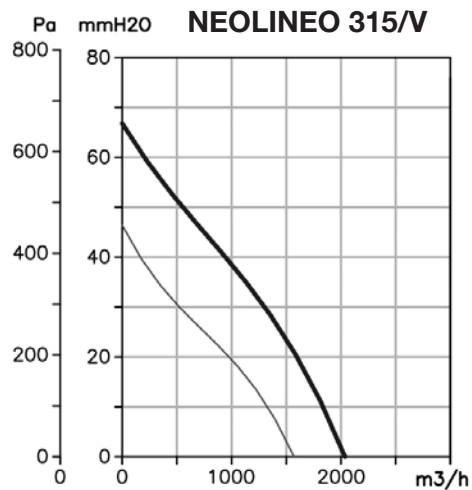
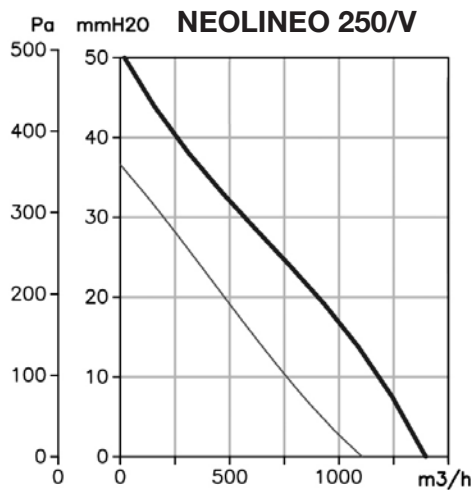
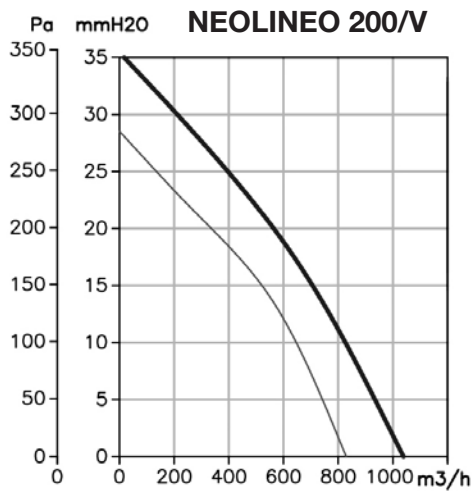
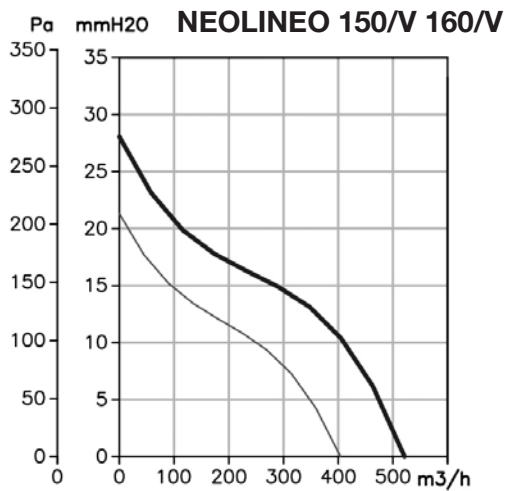
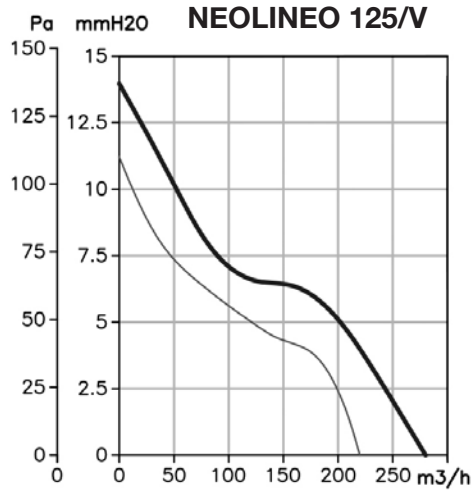
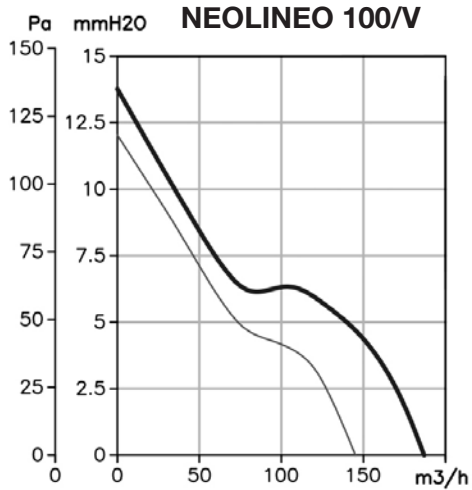

# NEOSILENT

**Low-noise, in-line duct extractor fans fitted with durable ball bearings.**



**Fan:**

- Sheet steel casing.
- Thermal and acoustic insulation with rockwool.
- Internal perforated casing to facilitate noise absorption.
- External terminal box.
- Easy, rapid installation.

**Motor:**

- 2-speed motors with durable ball bearings and IPX4 protection.
- Single-phase 110-120V 60 Hz or 220/240V 60Hz.
- Operating temperature: -10 °C +60 °C.

**Finish:**

- Grey anticorrosive polymer coating.

**Order code**

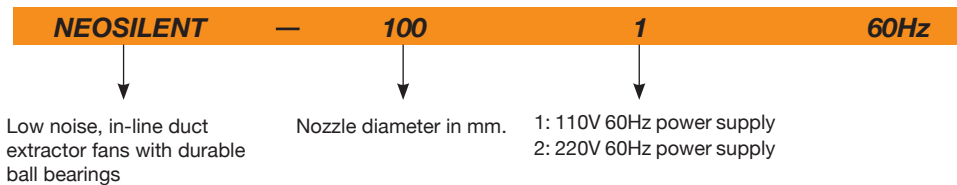

**Technical characteristics**



Model	Speed (r/min)	Maximum current (A)	Max. electric power (kW)	Maximum flow rate (m³/h)	Irradiated sound level* (dBA)	Approx. weight (kg)
	min./max.	min./max.	min./max.	min./max.	min./max.	
NEOSILENT 100	2030 / 2630	0.10/0.11	0.024 / 0.026	170 / 240	24 / 29	4.6
NEOSILENT 125	1650 / 2310	0.11/0.13	0.025 / 0.030	230 / 340	23 / 28	4.6
NEOSILENT 150	1970 / 2645	0.20/0.23	0.045 / 0.052	405 / 555	26 / 33	6.1
NEOSILENT 200	2015 / 2445	0.35/0.49	0.078 / 0.110	810 / 1020	31 / 36	8.0
NEOSILENT 250	1965 / 2495	0.52/0.79	0.127 / 0.178	1050 / 1330	34 / 38	15.0
NEOSILENT 315	1975 / 2545	0.93/1.41	0.213 / 0.313	1530 / 1950	36 / 40	25.0

\*Irradiated sound pressure levels obtained at a distance of 3 metres in a free field, with rigid intake/discharge tubes.

**Acoustic characteristics**

Sound power spectrum Lw(A) in dB(A) per Hz frequency band

Model	63	125	250	500	1000	2000	4000	8000
NEOSILENT 100	15	14	17	25	29	21	22	14
NEOSILENT 125	17	20	23	27	28	22	21	15
NEOSILENT 150	19	22	39	35	36	33	24	21
NEOSILENT 200	22	30	31	38	41	42	29	22
NEOSILENT 250	25	33	48	41	53	49	41	29
NEOSILENT 315	25	32	41	51	55	52	49	37

Dimensions mm

NEOSILENT 100...150

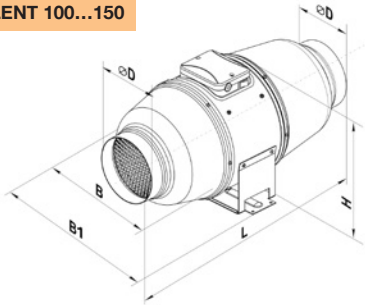

Model	ØD	B	B1	L	H
NEOSILENT 100	98	215	243	505	237
NEOSILENT 125	123	215	243	474	237
NEOSILENT 150	147	247	274	580	260

NEOSILENT 200...315

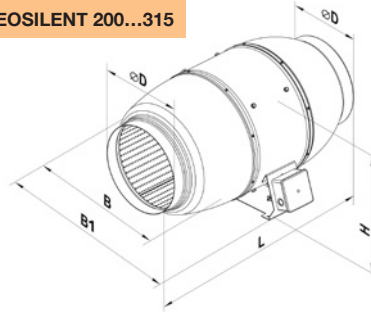

Model	ØD	B	B1	L	H
NEOSILENT 200	198	293	386	550	295
NEOSILENT 250	248	358	445	658	360
NEOSILENT 315	313	432	520	780	434

Characteristic curves

Q= Flow rate in m³/h      Pe= Static pressure in Pa

NEOSILENT 100

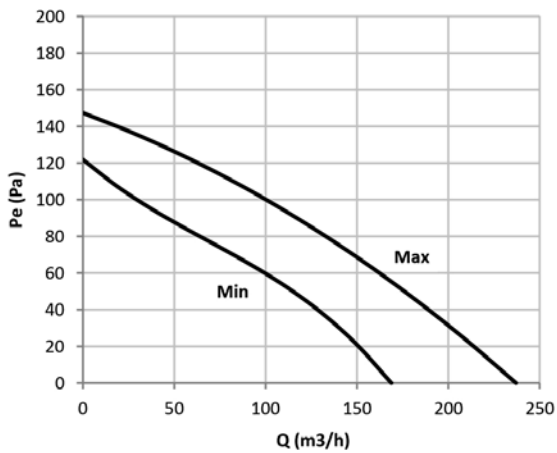

NEOSILENT 125

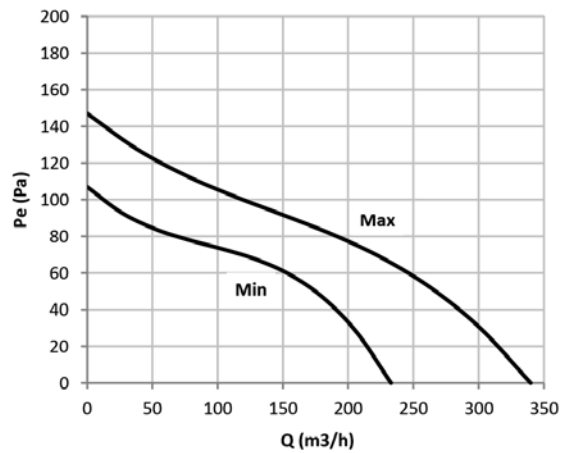

NEOSILENT 150

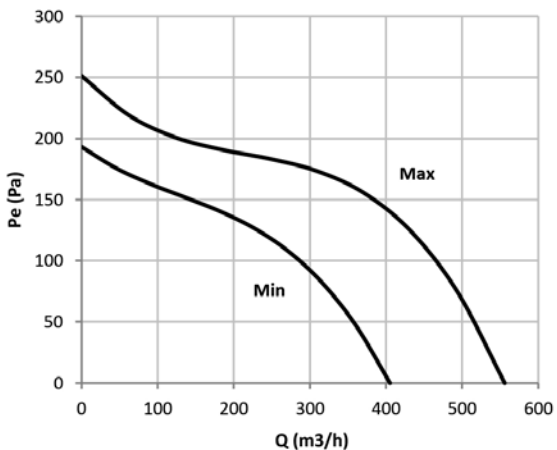

NEOSILENT 200

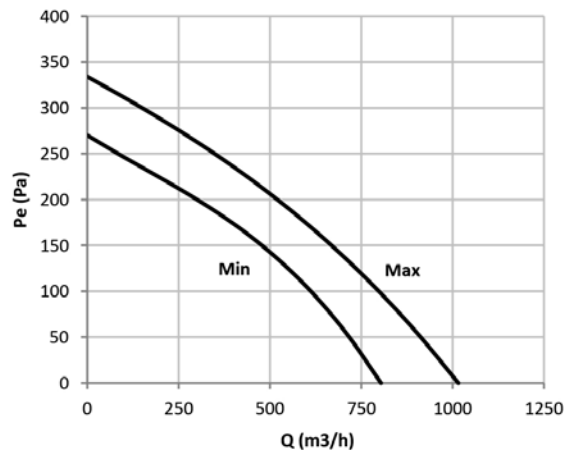

## Characteristic curves

Q= Flow rate in m<sup>3</sup>/h      Pe= Static pressure in Pa

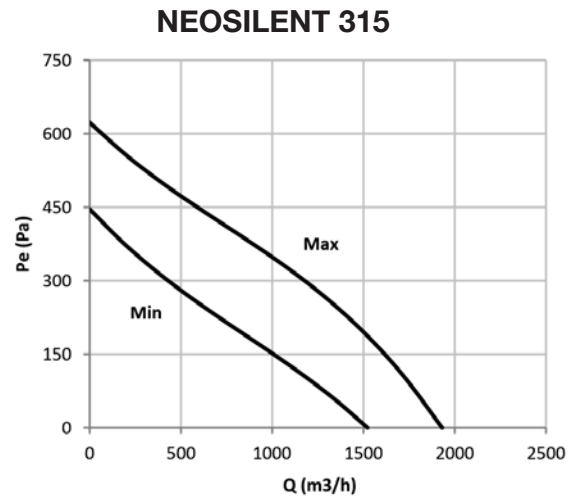
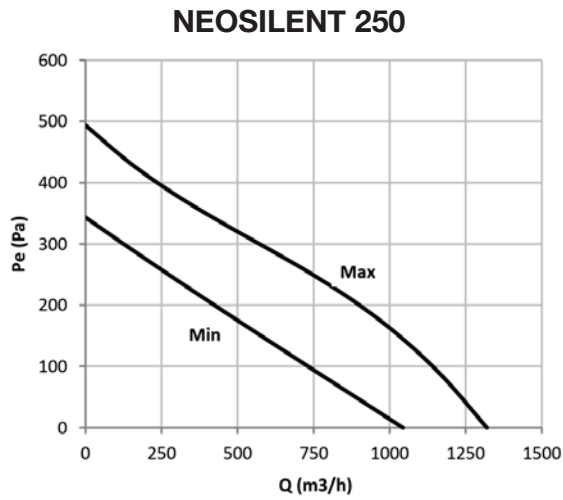

## Accessories

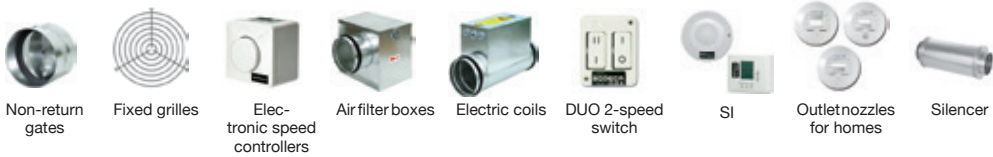

# EDMF



## Extra-flat bathroom extractor fans with a modern appearance and design

- Architectural integration with the bathroom elements.
- Ultra-silent.
- Extra-flat design with a thickness of just 17 mm.
- High performance thanks to its aerodynamic design.
- Can be easily and quickly installed.

### Construction:

- White finish.
- Non-return hatch built into all models.
- Made with recyclable materials.

### Motor:

- Single phase 110V 60Hz or 220V 60Hz as per order.

### Version

- BASIC: operates with a light switch or a separate switch.
- TIMER: operates with an adjustable electronic timer.
- LL: Long life ball bearings.



## Order code

<b>EDMF</b>	—	<b>LL</b>	—	<b>1</b>	—	<b>60Hz</b>
↓		↓		↓		
Extra-flat bathroom extractor fans with a modern appearance and design		Long life ball bearings		1: 110V 60Hz power supply 2: 220V 60Hz power supply		

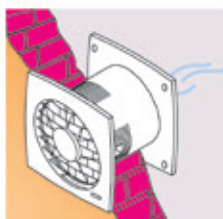

## Technical characteristics

**60Hz**

Model	Version	Speed (rpm)	Max. electric power (kW)	Max. flow rate (m <sup>3</sup> /h)	Sound pressure dB(A)	Weight (kg)
EDMF-100	Basic	2300	14	95	34	0.58
EDMF-100-T	Timer	2300	14	95	34	0.58
EDMF-100-LL	LL	2300	14	95	34	0.58
EDMF-100-LL-T	LL/Timer	2300	14	95	34	0.58
EDMF-120	Basic	2400	16	180	35	0.74
EDMF-120-T	Timer	2400	16	180	35	0.74
EDMF-120-LL	LL	2400	16	180	35	0.74
EDMF-150	Basic	2400	24	292	38	0.92
EDMF-150-T	Timer	2400	24	292	38	0.92
EDMF-150-LL	LL	2400	24	292	38	0.92

## Dimensions mm

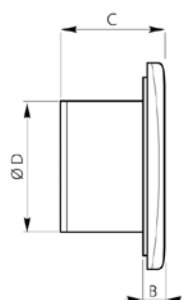
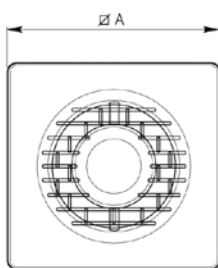

Model	∅A	B	C	∅D
EDMF-100	150	12.5	108	98
EDMF-100-T	150	12.5	108	98
EDMF-100-LL	150	12.5	108	98
EDMF-100-LL-T	150	12.5	108	98
EDMF-120	176	12.5	114	124
EDMF-120-T	176	12.5	114	124
EDMF-120-LL	176	12.5	114	124
EDMF-150	205	13	132	149
EDMF-150-T	205	13	132	149
EDMF-150-LL	205	13	132	149



**Characteristic curves**

Q= Flow rate in m<sup>3</sup>/h and m<sup>3</sup>/s. Pe= Static pressure in Pa.

**EDMF 100**

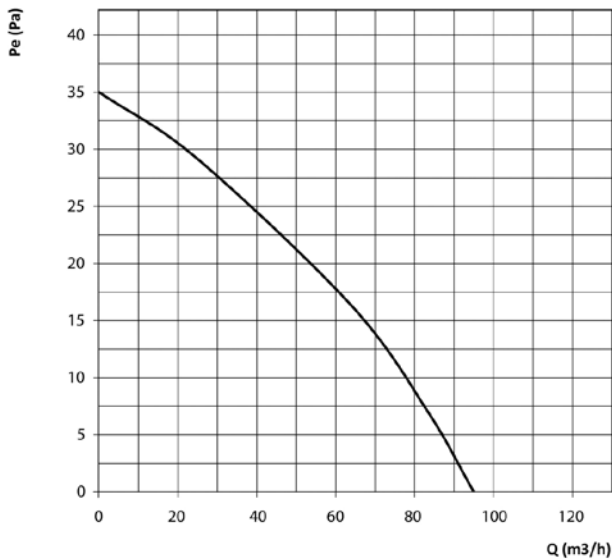

**EDMF 125**

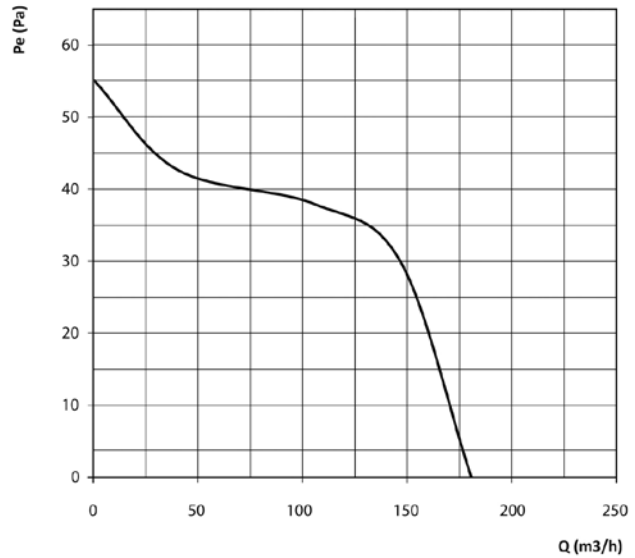

**EDMF 150**

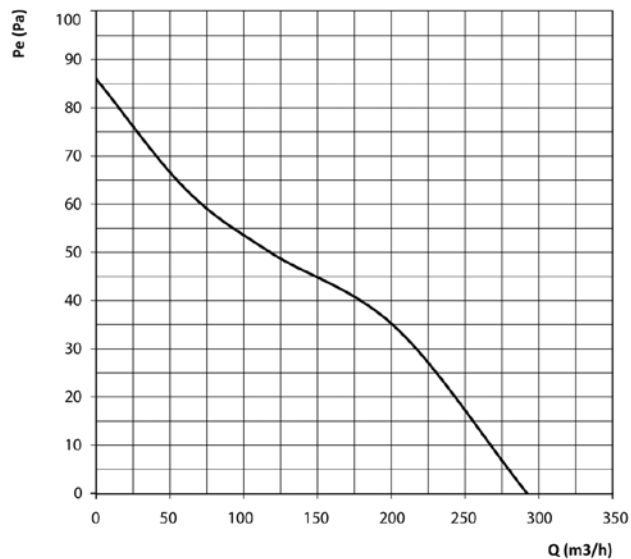

**Accessories**



Decorative grille



Overpressure blind



Electronic speed controllers

**AXIAL EXTRACTOR FANS**

<p><b>HC</b></p>  <p>Wall-mounted axial fans with IP55 motors</p> <p>27</p>	<p><b>HGI</b></p>  <p>Axial fans with large diameters</p> <p>33</p>	<p><b>HCD</b></p>  <p>Wall-mounted axial fans with small diameters</p> <p>35</p>	<p><b>HCH</b></p>  <p>Extremely robust wall-mounted, tubular, axial fans</p> <p>37</p>	<p><b>HCT</b></p>  <p>Extremely robust wall-mounted, tubular, axial fans</p> <p>37</p>
<p><b>CJHCH</b></p>  <p>Axial ventilation units with acoustically-isolated box</p> <p>49</p>	<p><b>HCT/IMP-C</b></p>  <p>Long-range, circular, one-way or reversible jet fans</p> <p>52</p>	<p><b>HCT/IMP</b></p>  <p>Long-range one-way or reversible jet fans</p> <p>54</p>	<p><b>HFW</b></p>  <p>Hot dip galvanised tubular fans</p> <p>57</p>	<p><b>HTP</b></p>  <p>High pressure tubular axial extractor fans</p> <p>62</p>
<p><b>HGT HGTX</b></p>  <p>Tubular axial fans with large diameters and direct drive motors.</p> <p>75</p>	<p><b>HPX</b></p>  <p>Tubular axial fans with external motors</p> <p>102</p>	<p><b>HBA</b></p>  <p>Forked tubular axial fans</p> <p>105</p>		

# HC

## Wall-mounted axial fans with IP55 motors

Wall-mounted axial fans with reinforced plastic rotor made of fibreglass.



HC



HC  
71 80  
90.100

**Fan:**

- Sheet steel support frame.
- Fibreglass reinforced polyamide-6 rotor.
- Anti-contact protective grille pursuant to standard UNE-EN ISO 12499.
- Models 71, 80, 90 and 100, protective grille supplied as an accessory.
- Airflow direction from Motor to Impeller.

**Motor:**

- IE3 efficiency motors for powers equal to or greater than 0.75kW except single-phase, 2-speed and 8-pole.
- Class F motors with ball bearings, IP55 protection, except single-phase models from size 45 to size 63, IP54 protection. With 1 or 2 speed, depending on model.
- Multi voltage motor, special design valid for 220/380V 60Hz, 254/440V 60Hz, 265/460V 60Hz, 277/480V 60Hz.
- Operating temperature: -25°C +60 °C.

**Finish:**

- Anti-corrosive finish of polyester resin polymerised at 190 °C, previously degreased with phosphate-free nanotechnological treatment.

**On request:**

- Motor, rotor and grille unit (version F).
- Rotor motor unit, version G.
- Airflow direction from Impeller to Motor.
- Special windings for different voltages.

### Order code

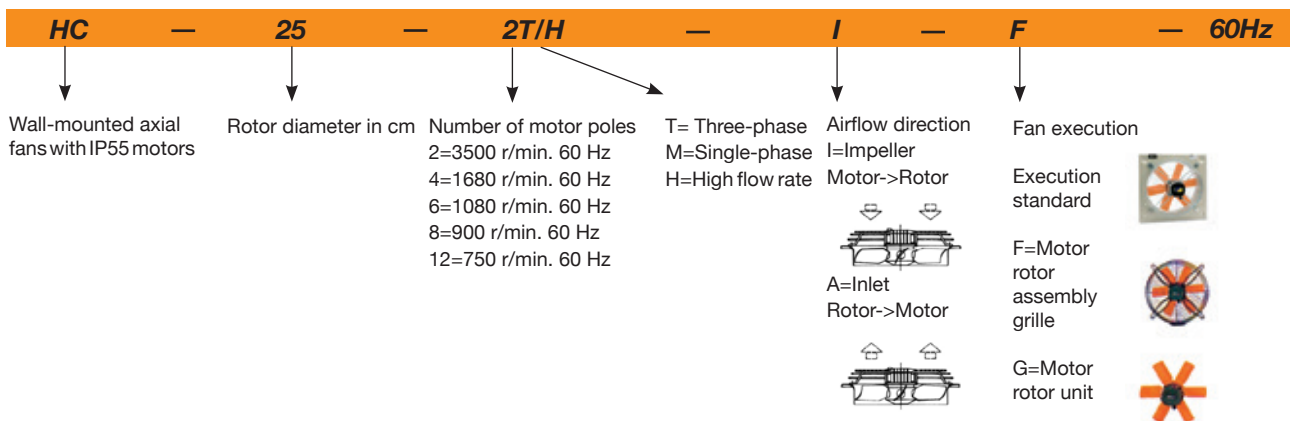

### Technical characteristics

60Hz

Model	Speed (r/min)	Maximum admissible current (A)		Installed power (kW)	Max. flow rate (m³/h)	Sound pressure level dB(A)	Approx. weight (kg)
		220-277V	380-480V				
HC-25-2T/H	2730	0.74	0.43	0.12	2200	64	5
HC-25-2M/H	2770	0.98		0.12	2200	64	5
HC-25-4T/H	1320	0.96	0.56	0.10	1300	51	5
HC-25-4M/H	1380	0.65		0.10	1300	51	5
HC-31-2T/H	2750	1.21	0.70	0.18	3650	72	6
HC-31-2M/H	2700	1.85		0.18	3600	72	6
HC-31-4T/H	1320	0.96	0.56	0.10	2400	54	6
HC-31-4M/H	1380	1.03		0.10	2400	54	6
HC-35-2T/H	2710	1.92	1.11	0.37	6050	76	8

### Technical characteristics

Model	Speed (r/min)	Maximum admissible current (A)		Installed power (kW)	Max. flow rate (m <sup>3</sup> /h)	Sound pressure level dB(A)	Approx. weight (kg)
		220-277V	380-480V				
HC-35-4T/H	1320	0.96	0.56	0.10	3550	58	7
HC-35-4M/H	1380	1.03		0.10	3550	58	7
HC-40-4T/H	1350	1.66	0.96	0.25	5200	63	10
HC-40-4M/H	1370	2.00		0.25	5200	63	10
HC-40-6T/H	900	1.51	0.87	0.25	3700	55	10
HC-40-6M/H	970	1.30		0.25	3700	55	10
HC-45-4T/H	1370	2.02	1.17	0.37	7300	66	14
HC-45-4M/H	1400	2.76		0.37	7300	66	14
HC-45-6T/H	900	1.51	0.87	0.25	5150	57	14
HC-45-6M/H	950	1.50		0.25	5150	57	14
HC-50-4T/H	1380	2.92	1.69	0.55	10200	69	18
HC-50-4M/H	1350	5.02		0.55	10200	69	18
HC-50-6T/H	900	2.24	1.30	0.37	6300	59	18
HC-50-6M/H	900	2.69		0.37	6300	59	18
HC-56-4T/H IE3	1400	4.03	2.32	1.10	13000	72	24
HC-56-4/8T/H	1440 / 710		2.9 / 1.3	1.10/0.25	13000/6500	72/57	24
HC-56-6T/H	900	2.24	1.30	0.37	8300	61	19
HC-56-6M/H	900	2.69		0.37	8300	61	19
HC-63-4T/H IE3	1400	4.03	2.32	1.10	16450	74	26
HC-63-4/8T/H	1440 / 710		2.9 / 1.3	1.10/0.25	16450/8225	74/59	26
HC-63-6T/H	900	2.24	1.30	0.37	12350	64	21
HC-63-6M/H	890	3.00		0.37	12350	64	21
HC-71-4T/H IE3	1430	5.96	3.44	1.50	22150	78	35
HC-71-4/8T/H	1420 / 700		3.5 / 1.5	1.50/0.37	22200/11100	78/63	35
HC-71-6T/H IE3	945	3.90	2.20	0.75	17300	66	36
HC-71-6M/H IE3	900	4.97		0.75	15600	65	36
HC-80-4T/H IE3	1445	10.96	6.33	3.00	33000	82	55
HC-80-4/8T/H	1430 / 710		6.5 / 2.3	3.0/0.60	33000/16500	82/67	53
HC-80-6T/H IE3	945	3.90	2.20	0.75	22000	71	45
HC-90-4T/H IE3	1440	14.10	8.12	4.00	43700	86	68
HC-90-4/8T/H	1430 / 710		8.2 / 2.9	4.00/0.80	43700/21850	86/69	74
HC-90-6T/H IE3	955	6.42	3.71	1.50	33300	76	60
HC-90-8T/H	695	3.53	2.04	0.55	19800	69	54
HC-100-4T/H IE3	1440		11.60	5.50	54000	88	85
HC-100-4/8T/H	1450 / 720		11.8 / 3.8	5.50/1.10	54000/27000	88/73	95
HC-100-6T/H IE3	955	6.42	3.71	1.50	37000	78	63
HC-100-8T/H	705	4.68	2.70	0.75	26950	72	61

### Acoustic characteristics

The indicated values are determined by measuring the sound pressure level and sound power in dB(A) obtained in a free field at a distance equivalent to twice the size of the fan plus the rotor diameter, with a minimum of 1.5 m.

Sound power spectrum Lw(A) in dB(A) per Hz frequency band

Model	63	125	250	500	1000	2000	4000	8000	Model	63	125	250	500	1000	2000	4000	8000
25-2T/H	38	48	65	65	73	69	62	53	63-4/8T/H	43	60	73	80	85	86	81	74
25-4T/H	25	35	52	52	60	56	49	40	63-6T/H	33	50	63	70	75	76	71	64
31-2T/H	46	56	73	73	81	77	70	61	71-4T/H	47	64	77	84	89	90	85	78
31-4T/H	28	38	55	55	63	59	52	43	71-4/8T/H	47	64	77	84	89	90	85	78
35-2T/H	50	60	77	77	85	81	74	65	71-6T/H	35	52	65	72	77	78	73	66
35-4T/H	32	42	59	59	67	63	56	47	80-4T/H	60	81	88	93	96	92	85	74
40-4T/H	28	45	57	65	70	70	66	59	80-4/8T/H	60	81	88	93	96	92	85	74
40-6T/H	20	37	49	57	62	62	58	51	80-6T/H	49	70	77	82	85	81	74	63
45-4T/H	33	50	63	70	75	76	71	64	90-4T/H	64	85	92	97	100	96	89	78
45-6T/H	24	41	54	61	66	67	62	55	90-4/8T/H	64	85	92	97	100	96	89	78
50-4T/H	36	53	66	73	78	79	74	67	90-6T/H	54	75	82	87	90	86	79	68
50-6T/H	26	43	56	63	68	69	64	57	90-8T/H	47	68	75	80	83	79	72	61
56-4T/H	39	56	69	76	81	82	77	70	100-4T/H	68	88	96	101	103	100	93	82
56-4/8T/H	39	56	69	76	81	82	77	70	100-4/8T/H	68	88	96	101	103	100	93	82
56-6T/H	28	45	58	65	70	71	66	59	100-6T/H	58	78	86	91	93	90	83	72
63-4T/H	43	60	73	80	85	86	81	74	100-8T/H	52	72	80	85	87	84	77	66

Dimensions mm

HC 25...63

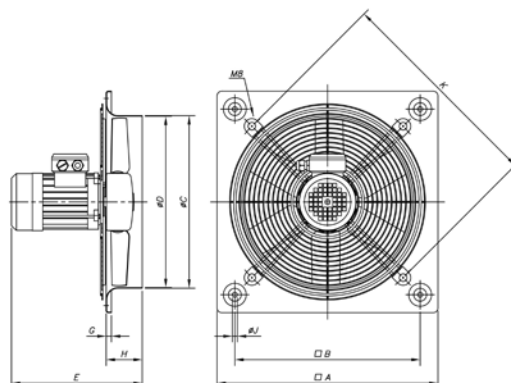

Model	A	B	ØC	ØD	E	G	H	ØJ	K
HC-25	330	275	262	260	241	11	56	8.5	310
HC-31-2	400	336	310.5	308	264.5	11	65	8.5	380
HC-31-4	400	336	310.5	308	245.5	11	65	8.5	380
HC-35-2	465	390	362.5	360	310	11	76	10.5	450
HC-35-4	465	390	362.5	360	261	11	76	10.5	450
HC-40-4.../H	532	452	412.5	410	332	11	97.5	10.5	500
HC-40-6.../H	532	452	412.5	410	332	11	97.5	10.5	500
HC-45-4.../H	596	504	462.5	460	339	11	105	10.5	560
HC-45-6.../H	596	504	462.5	460	339	11	105	10.5	560
HC-50-4T/H	665	562	516.5	514	376	11	115	10.5	640
HC-50-4M/H	665	562	516.5	514	376	11	115	10.5	640
HC-50-6.../H	665	562	516.5	514	336	11	115	10.5	640
HC-56-4T/H	710	630	563	560	374	15	115	10.5	721
HC-56-6.../H	710	630	563	560	351	15	115	10.5	721
HC-63-4T/H	800	710	638	635	399	15	140	10.5	820
HC-63-6.../H	800	710	638	635	376	15	140	10.5	820

HC 71...100

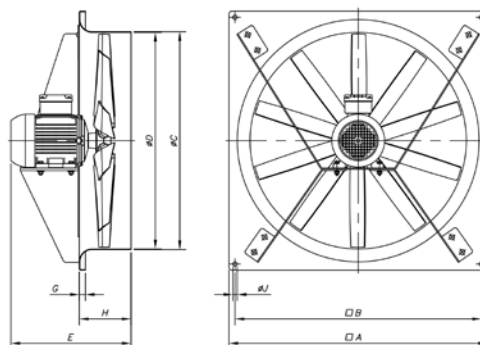

Model	A	B	ØC	ØD	E	G	H	ØJ
HC-71-4T/H	850	810	715	711	395	20	170	14.5
HC-71-6T/H	850	810	715	711	395	20	170	14.5
HC-80-4T/H	970	910	801	797	500	20	210	14.5
HC-80-6T/H	970	910	801	797	458	20	210	14.5
HC-90-4T/H	1170	1110	918	914	511	20	210	14.5
HC-90-6T/H	1170	1110	918	914	500	20	210	14.5
HC-90-8T/H	1170	1110	918	914	455	20	210	14.5
HC-100-4T/H	1170	1110	1003	999	548	20	220	14.5
HC-100-6T/H	1170	1110	1003	999	498	20	220	14.5
HC-100-8T/H	1170	1110	1003	999	498	20	220	14.5

**Characteristic curves**

Q= Flow rate in m<sup>3</sup>/h, m<sup>3</sup>/s and cfm.

Pe= Static pressure in mm H<sub>2</sub>O, Pa and inwg.

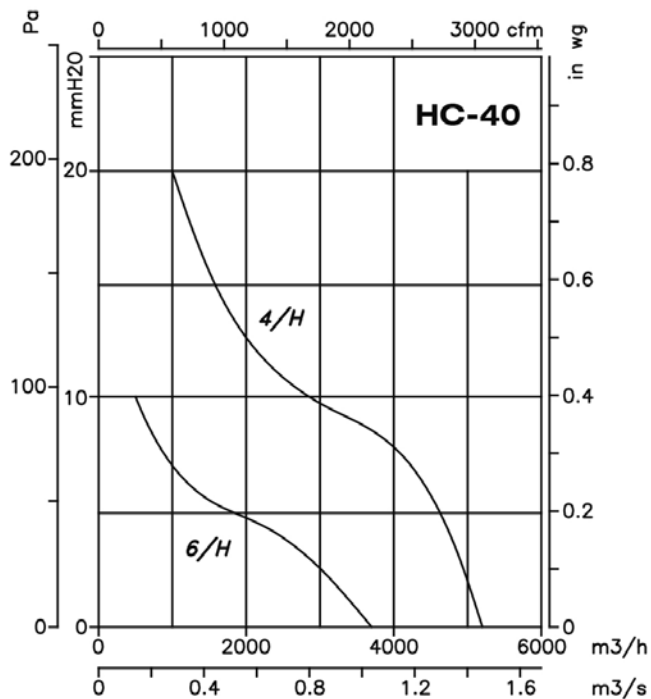
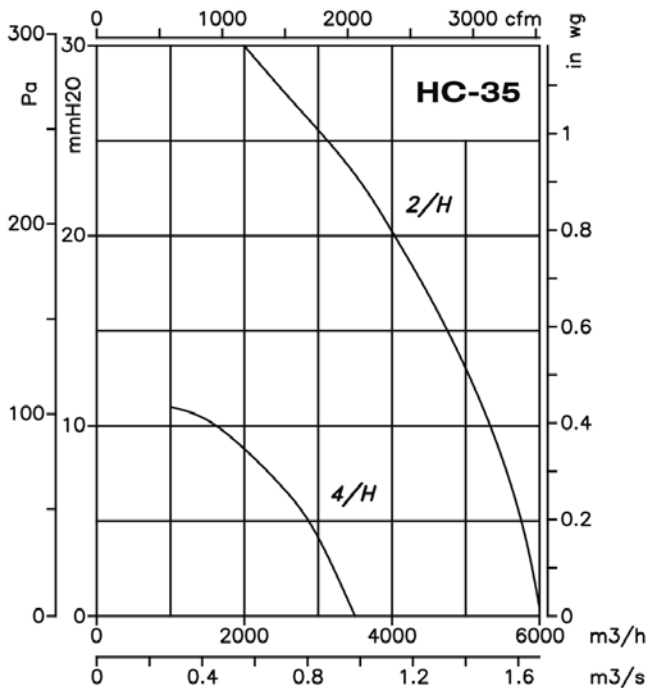
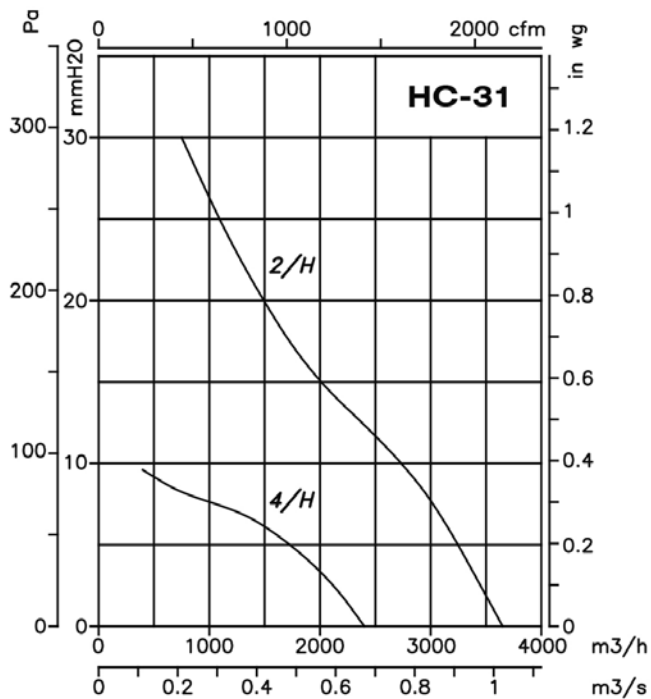
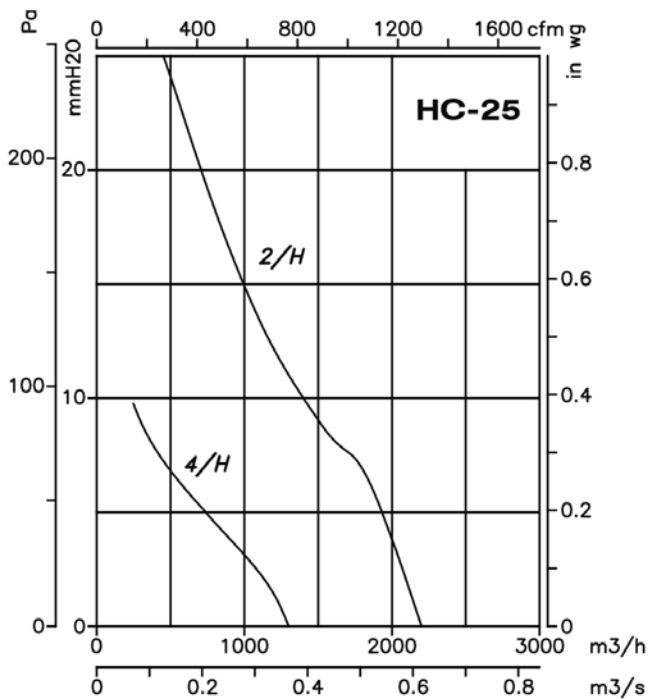

**Characteristic curves**

Q= Flow rate in m<sup>3</sup>/h, m<sup>3</sup>/s and cfm.

Pe= Static pressure in mm H<sub>2</sub>O, Pa and inwg.

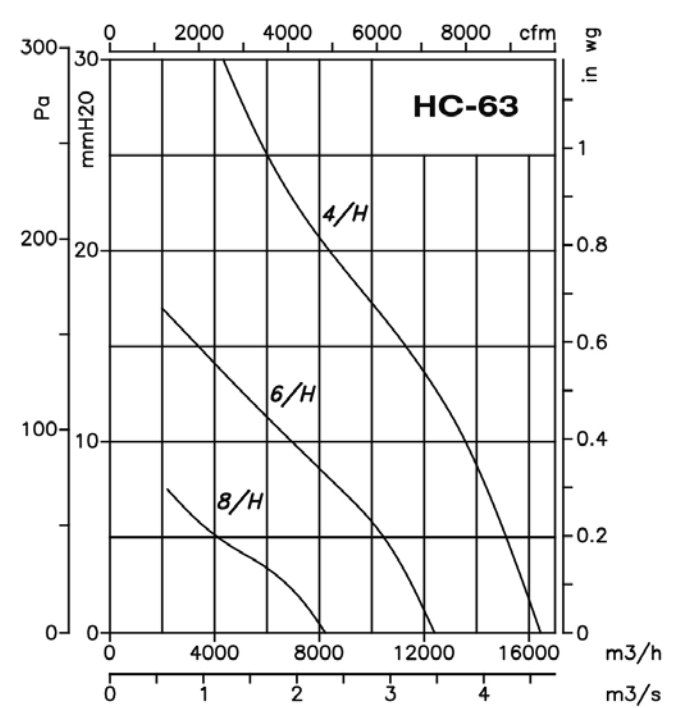
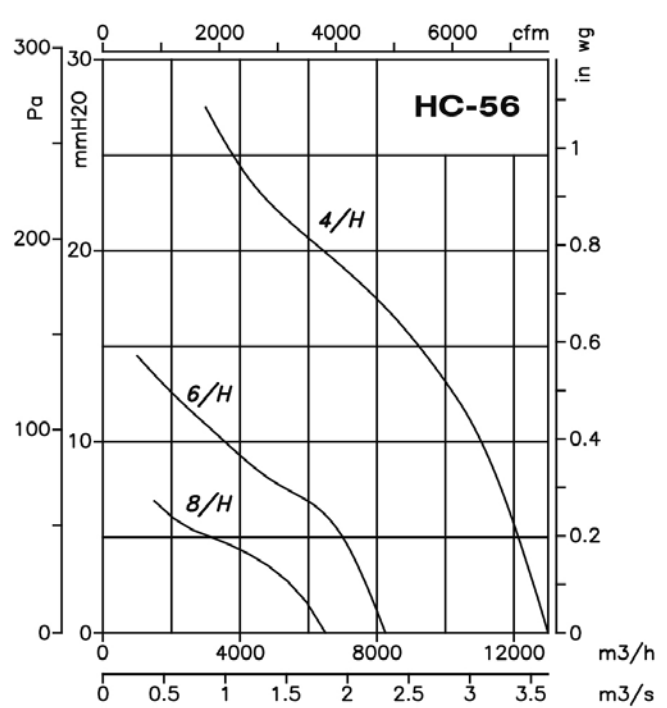
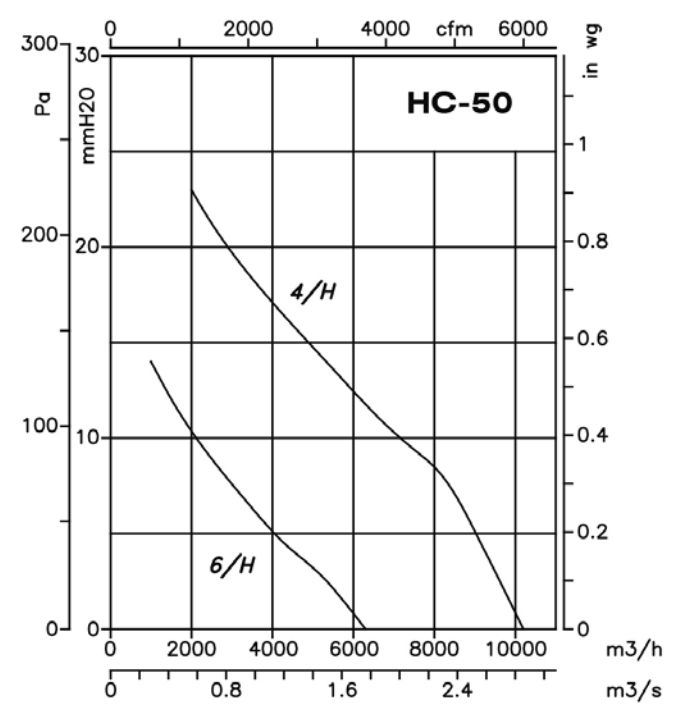
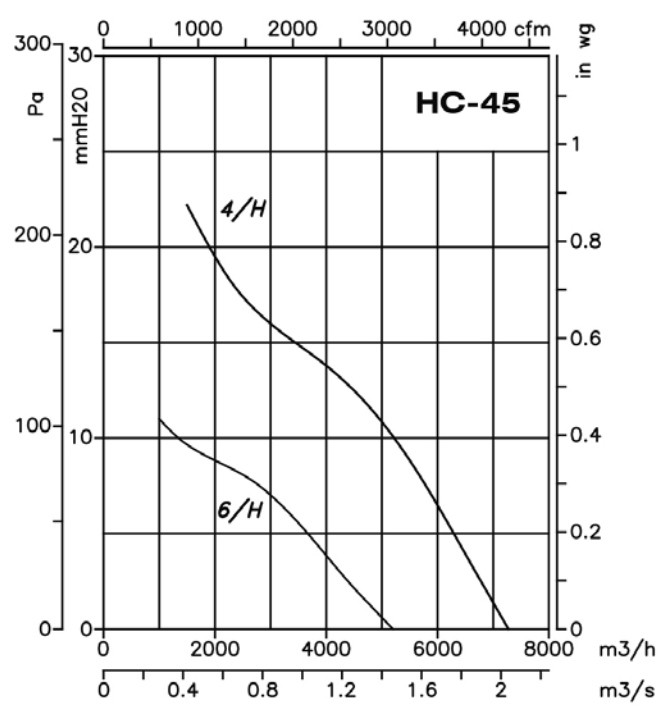

**Characteristic curves**

Q= Flow rate in m<sup>3</sup>/h, m<sup>3</sup>/s and cfm.

Pe= Static pressure in mm H<sub>2</sub>O, Pa and inwg.

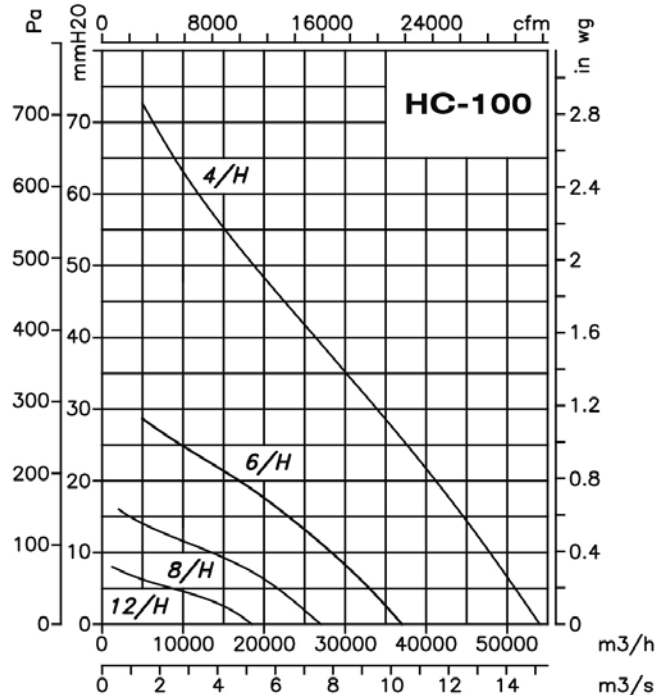
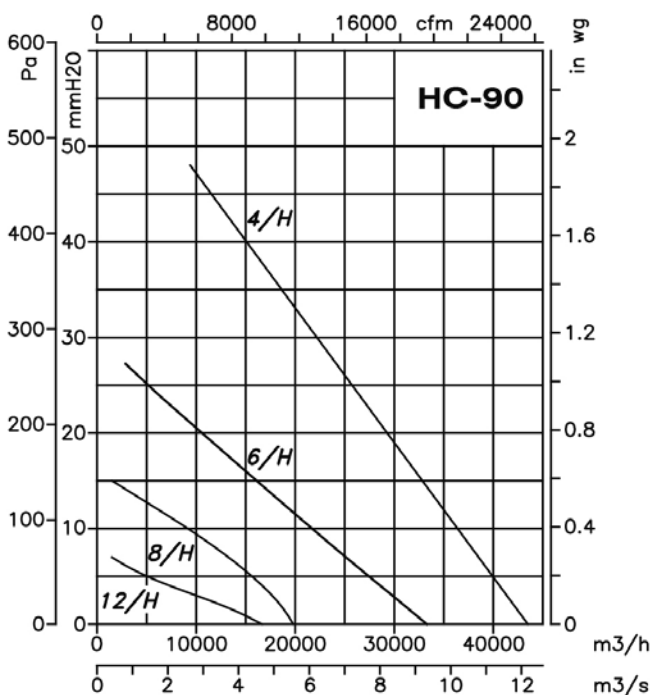
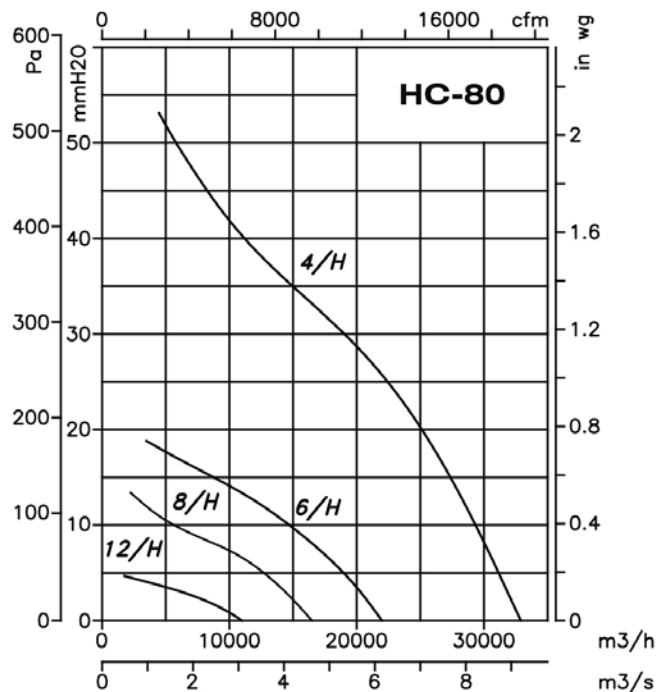
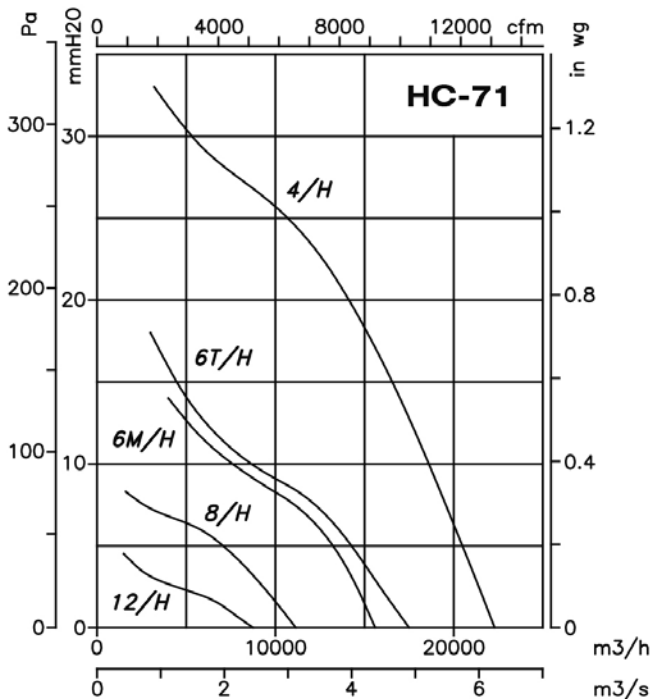

**Accessories**





# HGI



## Axial fans with large diameters

Wall-mounted axial fans designed for large airflows at low speed with automatic opening blind.

### Fan:

- Sheet steel support frame.
- Galvanised sheet steel structure.
- Galvanised sheet steel rotor.
- Anti-contact protective grille pursuant to standard UNE-EN ISO 12499:2010.
- Specially designed for use in farms and greenhouses.
- Airflow direction from Motor to Impeller.

### Motor:

- IE3 efficiency motors for powers equal to or greater than 0.75kW except single-phase, 2-speed and 8-pole.

- Class F motors with ball bearings and IP55 protection.
- Multi voltage motor, special design valid for 220/380V 60Hz, 254/440V 60Hz, 265/460V 60Hz, 277/480V 60Hz.
- Operating temperature: -25 °C+ 50 °C.

### Finish:

- Anti-corrosive finished galvanised sheet steel.

### On request:

- Without blind and with protective grille on the impulsion side.
- Special windings for different voltages.

## Order code

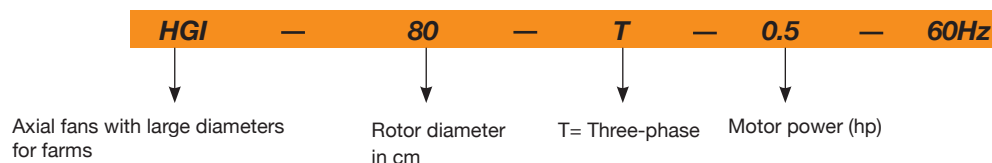

**60Hz**

## Technical characteristics

Model	Speed (r/min)	Maximum admissible current (A)		Installed power (kW)	Maximum flow rate (m <sup>3</sup> /h)	Sound pressure level dB(A)	Approx. weight (kg)
		220-277V	380-480V				
HGI-80-T-0.5	570	1.70	1.00	0.37	16000	63	48
HGI-80-T-0,75	630	2.40	1.40	0.55	18000	65	49
HGI-100-T-0.5	398	2.10	1.20	0.37	25000	62	63
HGI-100-T-0,75	472	2.80	1.60	0.55	29000	65	64
HGI-100-T-1	503	3.50	2.00	0.75	32000	66	66
HGI-125-T-1	437	3.50	2.00	0.75	38000	69	87
HGI-125-T-1,5	485	4.80	2.80	1.10	43000	72	90

## Acoustic characteristics

The indicated values are determined by measuring the sound pressure level and sound power in dB(A) obtained in a free field at a distance equivalent to twice the size of the fan plus the rotor diameter, with a minimum of 1.5 m.

Sound power spectrum Lw(A) in dB(A) frequency band in [Hz]

Model	63	125	250	500	1000	2000	4000	8000	Model	63	125	250	500	1000	2000	4000	8000
HGI-80-T-0.5	57	64	72	74	72	69	66	58	HGI-100-T-1	61	69	77	79	77	74	70	63
HGI-80-T-0,75	59	66	74	76	74	71	68	60	HGI-125-T-1	64	72	80	82	80	77	73	66
HGI-100-T-0,5	57	65	73	75	73	70	66	59	HGI-125-T-1,5	67	75	83	85	83	80	76	69
HGI-100-T-0,75	60	68	76	78	76	73	69	62									

**Characteristic curves**

Q= Flow rate in m<sup>3</sup>/h, m<sup>3</sup>/s and cfm.

Pe= Static pressure in mm H<sub>2</sub>O, Pa and inwg.

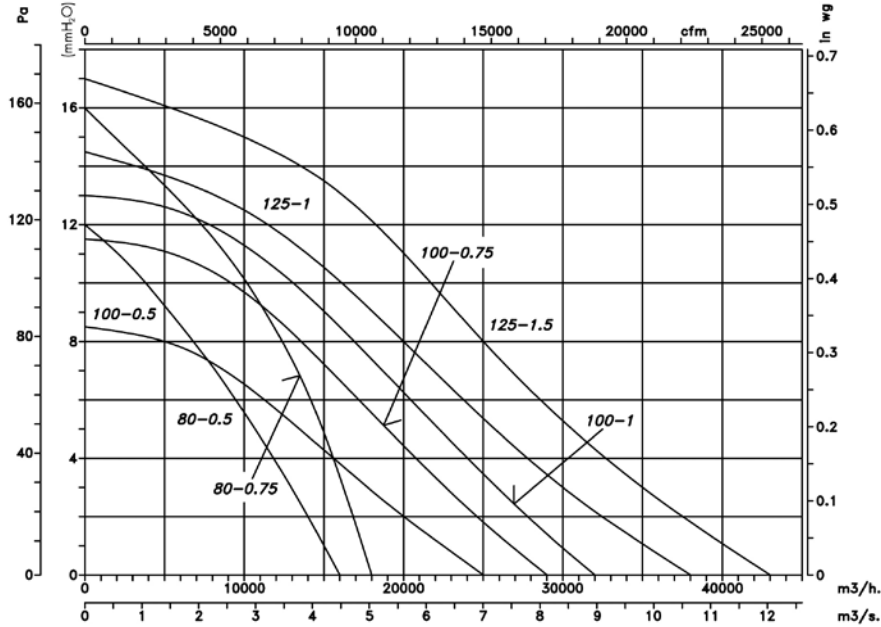

**Dimensions mm**

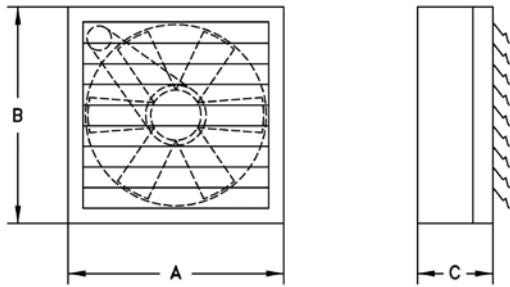

Model	A	B	C
HGI-80	925	925	427
HGI-100	1125	1125	447
HGI-125	1375	1375	480

**Accessories**



# HCD

## Wall-mounted axial fans with small diameters



Wall-mounted axial fans with an aluminium sheet rotor, split capacitor motors and built-in connection cable.

**Fan:**

- Sheet steel support frame.
- Aluminium sheet rotor.
- Anti-contact protective grille pursuant to standard UNE-EN ISO 12499.
- Airflow direction from Motor to Impeller.

**Motor:**

- Class B motors with self-lubricating friction bearings, IP44 protection, except model 40 fitted with an F class motor with ball bearings and IP54 protection.
- Single-phase 110V/120V. 60Hz or 220V 60Hz.
- Operating temperature: -25 °C+ 50 °C.

**Finish:**

- Anti-corrosive finish of polyester resin polymerised at 190 °C, previously degreased with phosphate-free nanotechnological treatment.

**On request:**

- Special windings for different voltages.

### Order code

**HCD — 20 — 4M — 1 — 60Hz**

Wall-mounted axial fans with small diameters

Rotor diameter in cm

Number of motor poles  
4=1680 r/min. 60 Hz

M=Single-phase

1: 110V 60Hz power supply  
2: 220V 60Hz power supply

### Technical characteristics

60Hz

Model	Speed (r/min)	Maximum admissible current (A)		Absorb. power desc. Free (W)	Max. flow rate (m <sup>3</sup> /h)	Sound pressure level dB(A)	Approx. weight (kg)
		110V	220V				
HCD-20-4M	1580	0.45	0.21	36	560	38	1.15
HCD-25-4M	1550	0.63	0.25	50	960	43	1.60
HCD-30-4M	1550	0.76	0.51	76	1350	48	2.15
HCD-35-4M	1460	1.53	0.80	115	1820	53	6.20
HCD-40-4M	1550	2.20	1.10	180	3100	57	7.20

### Dimensions mm

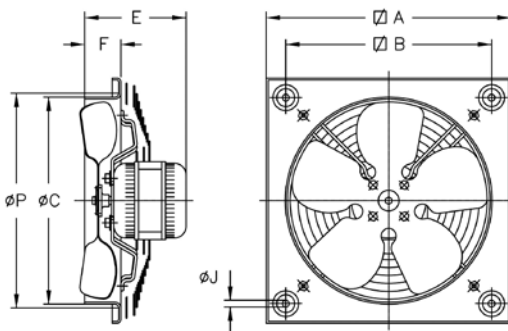

Model	ØA	ØB	ØC	E	F	ØJ	ØP
HCD-20	266	222	211	104.5	34	9	240
HCD-25	330	275	262	105.5	56	10.5	290
HCD-30	400	336	311	153	75	10.5	348
HCD-35	465	390	363	166	86	10.5	410
HCD-40	532	452	413	276	97.5	10.5	460

**Characteristic curves**

Q= Flow rate in m<sup>3</sup>/h, m<sup>3</sup>/s and cfm.

Pe= Static pressure in mm H<sub>2</sub>O, Pa and inwg.

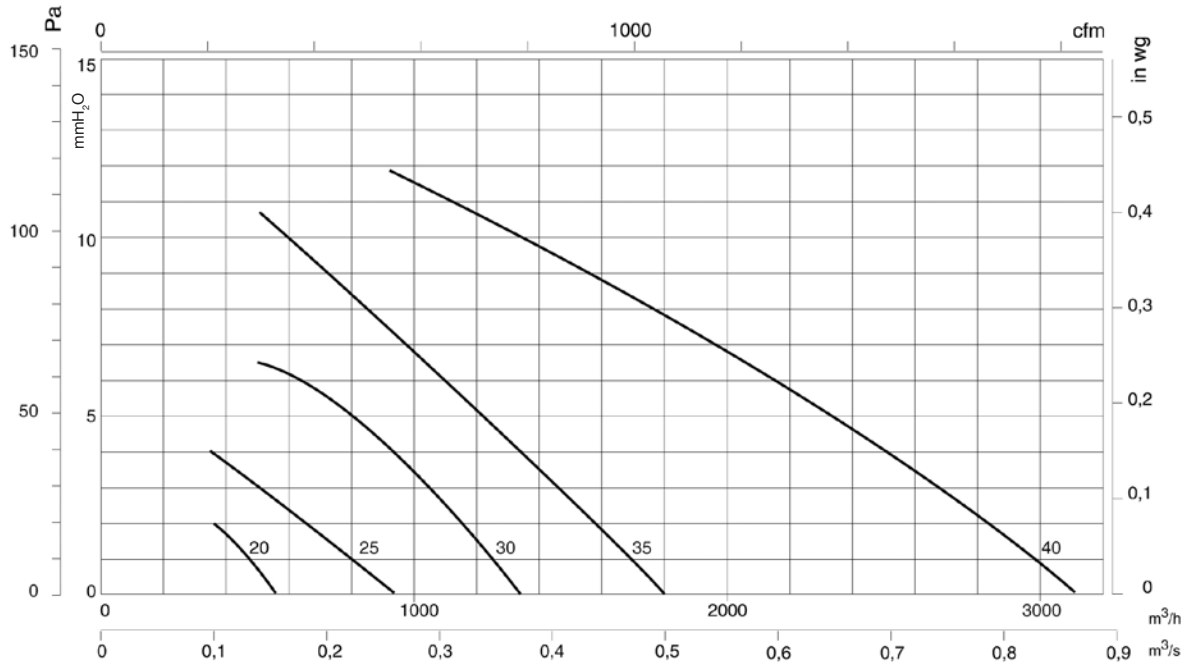

**Accessories**

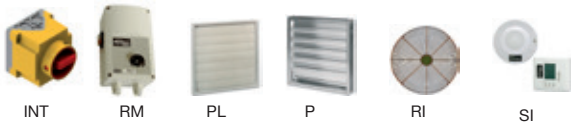

# HCH HCT

## Extremely robust wall-mounted, axial or tubular fans

Axial or tubular wall-mounted fans, PL version fitted with a plastic rotor and AL version with an aluminium rotor.

**Fan:**

- Airflow direction from Motor to Impeller.
- PL version in fibreglass-reinforced polyamide-6 rots and AL version in cast aluminium.  
Models HCT-40-2T and HCT-45-2T only in AL version.
- HCH: Sheet steel support ring.
- HCT: Tubular casing in sheet steel with external terminal box.

**Motor:**

- IE3 efficiency motors for powers equal to or greater than 0.75kW except single-phase, 2-speed and 8-pole.
- Class F motors with ball bearings, IP55 protection, except single-phase models from size 45 to size 56, IP54 protection. 1 or 2 speeds, depending on model.
- Multi voltage motor, special design valid for 220/380V 60Hz, 254/440V 60Hz, 265/460V 60Hz, 277/480V 60Hz.
- Operating temperature: -25 °C.+ 50 °C.

**Finish:**

- Anti-corrosive finish of polyester resin polymerised at 190 °C, previously degreased with phosphate-free nanotechnological treatment.

**On request:**

- Airflow direction from Impeller to Motor.
- Rotors 100% reversible.
- Special windings for different voltages.
- ATEX-certified Category 2.



HCH



HCT

### Order code

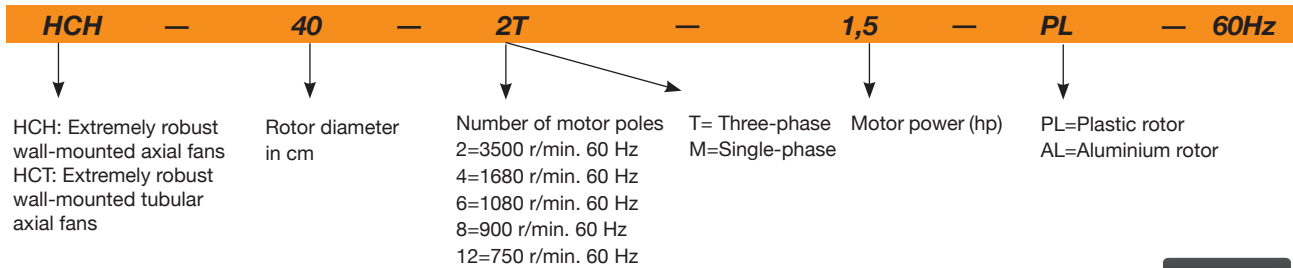

### Technical characteristics

60Hz

Model	Speed (r/min)	Maximum admissible current (A)		Installed power (kW)	Maximum flow rate (m <sup>3</sup> /h)	Sound pressure level dB(A)	Approx. weight	
		220-277V	380-480V				HCH	HCT
HCT 25-2T	3204	0.64	0.37	0.09	1950	64		7
HCT 25-2M	3312	0.79		0.09	1950	64		7
HCT 25-4T	1584	0.65	0.38	0.09	1000	50		7
HCT 25-4M	1656	0.65		0.10	1000	50		7
HCT 31-2T	3300	1.21	0.70	0.18	2900	70		8
HCT 31-2M	3336	1.42		0.18	2900	70		8
HCT 31-4T	1584	0.65	0.38	0.09	1550	52		8
HCT 31-4M	1656	0.65		0.10	1550	52		8
HCH HCT 35-2T	3252	1.92	1.11	0.37	5750	77	9	12
HCT 35-2M	3336	2.53		0.37	5750	77		12
HCH HCT 35-4T	1584	0.65	0.38	0.09	3100	59	7	10
HCT 35-4M	1656	0.65		0.10	3100	59		10
HCH HCT 40-2T-1.5	3432	4.20	2.40	1.10	8800	84	17	25
HCH HCT 40-4T-0.33	1620	1.66	0.96	0.25	5150	64	13	21
HCT 45-2T-2	3324	5.44	3.13	1.50	10650	86		31
HCT 45-2T-3	3462	7.77	4.47	2.20	12750	88		34
HCT 45-2/4T-3	3492 / 1704		5.00 / 1.60	2.20 / 0.60	12750/6375	88/73		33
HCH HCT 45-4T-0.5	1644	2.02	1.17	0.37	7100	68	15	24
HCH HCT 45-4M-0.5	1680	2.76		0.37	7100	68	15	24
HCH 45-6T-0.33	1080	1.51	0.87	0.25	4750	55	14	
HCH 45-6M-0.33	1140	1.30		0.25	4750	55	15	
HCT 50-4T-0.75	1656	2.92	1.69	0.55	10400	70		28
HCH HCT 56-4T-0.75	1656	2.92	1.69	0.55	11050	72	21	33
HCH HCT 56-4M-0.75	1740	4.40		0.55	11050	72	21	33

### Technical characteristics

Model	Speed (r/min)	Maximum admissible current (A)		Installed power (kW)	Maximum flow rate (m <sup>3</sup> /h)	Sound pressure level dB(A)	Approx. weight	
		220-277V	380-480V				HCH	HCT
HCH HCT 56-4T-1	1692	3.10	1.79	0.75	12950	73	22	34
HCH HCT 56-4/8T-1	1716 / 852		2.00 / 0.90	0.75 / 0.20	12950/6475	73/58	23	35
HCH HCT 56-4T-1.5	1680	4.03	2.32	1.10	14000	74	26	37
HCH HCT 56-4/8T-1.5	1728 / 852		2.90 / 1.30	1.10 / 0.25	14000/7000	74/59	24	35
HCH HCT 56-4T-2	1716	5.96	3.44	1.50	15300	75	28	39
HCH HCT 56-4/8T-2	1704 / 840		3.50 / 1.50	1.50 / 0.37	15300/7650	75/60	28	39
HCH HCT 56-6T-0.33	1080	1.51	0.87	0.25	8500	61	18	30
HCH HCT 56-6M-0.33	1140	1.85		0.25	8400	61	19	31
HCH HCT 56-6T-0.5	1080	2.24	1.30	0.37	9300	61	20	32
HCH HCT 56-6T-0.75	1080	2.99	1.73	0.55	10000	62	22	34
HCH HCT 63-4T-1	1692	3.10	1.79	0.75	14150	73	27	42
HCH HCT 63-4/8T-1	1716 / 852		2.00 / 0.90	0.75 / 0.20	14150/7075	73/58	27	43
HCH HCT 63-4T-1.5	1680	4.03	2.32	1.10	17000	74	30	45
HCH HCT 63-4/8T-1.5	1728 / 852		2.90 / 1.30	1.10 / 0.25	17000/8500	74/59	29	44
HCH HCT 63-4T-2	1716	5.96	3.44	1.50	18900	75	33	48
HCH HCT 63-4/8T-2	1704 / 840		3.50 / 1.50	1.50 / 0.37	18900/9450	75/60	32	48
HCH HCT 63-4T-3	1734	8.36	4.83	2.20	22100	76	41	57
HCH HCT 63-4/8T-3	1716 / 852		4.90 / 1.70	2.20 / 0.45	22100/11050	76/61	38	54
HCH HCT 63-4T-4	1734	10.96	6.33	3.00	25400	77	43	59
HCH HCT 63-4/8T-4	1716 / 852		6.50 / 2.30	3.00 / 0.60	25400/12700	77/62	42	57
HCH HCT 63-6T-0.5	1080	2.24	1.30	0.37	12150	64	25	40
HCH HCT 63-6M-0.5	1080	2.69		0.37	12150	64	25	40
HCH HCT 63-6T-0.75	1080	2.99	1.73	0.55	12750	65	27	42
HCH HCT 63-6T-1	1134	3.90	2.20	0.75	13800	66	33	48
HCH HCT 63-6/12T-1	1122 / 522		2.20 / 0.87	0.75 / 0.15	13800/6900	66/51	32	47
HCH HCT 71-4T-1.5	1680	4.03	2.32	1.10	19750	78	33	52
HCH HCT 71-4/8T-1.5	1728 / 852		2.90 / 1.30	1.10 / 0.25	19600/9800	78/63	32	51
HCH HCT 71-4T-2	1716	5.96	3.44	1.50	21100	79	36	55
HCH HCT 71-4/8T-2	1704 / 840		3.50 / 1.50	1.50 / 0.37	21100/10550	79/64	35	54
HCH HCT 71-4T-3	1734	8.36	4.83	2.20	23950	81	45	64
HCH HCT 71-4/8T-3	1716 / 852		4.90 / 1.70	2.20 / 0.45	24150/12075	81/66	42	61
HCH HCT 71-4T-4	1734	10.96	6.33	3.00	29400	82	47	66
HCH HCT 71-4/8T-4	1716 / 852		6.50 / 2.30	3.00 / 0.60	29550/14775	82/67	46	64
HCH HCT 71-6T-0.75	1080	2.99	1.73	0.55	15150	67	29	49
HCH HCT 71-6M-0.75	1080	3.84		0.55	15150	67	29	49
HCH HCT 71-6T-1	1134	3.90	2.20	0.75	17250	68	36	55
HCH HCT 71-6/12T-1	1122 / 522		2.20 / 0.87	0.75 / 0.15	17150/8575	68/53	35	54
HCH HCT 71-6T-1.5	1134	4.88	2.82	1.10	20950	69	38	57
HCH HCT 71-6/12T-1.5	1140 / 564		3.00 / 1.15	1.10 / 0.18	20950/10475	69/54	37	56
HCH HCT 80-4T-3	1734	8.36	4.83	2.20	28000	82	53	72
HCH HCT 80-4/8T-3	1716 / 852		4.90 / 1.70	2.20 / 0.45	28000/14000	82/67	50	69
HCH HCT 80-4T-4	1734	10.96	6.33	3.00	32700	83	55	74
HCH HCT 80-4/8T-4	1716 / 852		6.50 / 2.30	3.00 / 0.60	32700/16350	83/68	54	73
HCH HCT 80-4T-5.5	1728	14.10	8.12	4.00	37200	84	60	79
HCH HCT 80-4/8T-5.5	1716 / 852		8.20 / 2.90	4.00 / 0.80	37200/18600	84/69	66	85
HCH HCT 80-6T-1	1134	3.90	2.20	0.75	20600	71	44	64
HCH HCT 80-6/12T-1	1122 / 522		2.20 / 0.87	0.75 / 0.15	20600/10300	71/56	43	63
HCH HCT 80-6T-1.5	1134	4.88	2.82	1.10	24250	72	46	66
HCH HCT 80-6/12T-1.5	1140 / 564		3.00 / 1.15	1.10 / 0.18	24250/12125	72/57	45	65
HCH HCT 80-6T-2	1146	6.42	3.71	1.50	28000	73	52	71
HCH HCT 80-6/12T-2	1164 / 564		4.60 / 1.90	1.50 / 0.25	28000/14000	73/58	62	81
HCH HCT 80-6T-3	1146	9.30	5.30	2.20	32500	74	57	76
HCH HCT 80-6/12T-3	1128 / 564		5.60 / 2.20	2.20 / 0.37	32500/16250	74/59	62	81
HCH HCT 80-8T-0.5	840	2.77	1.60	0.37	16600	69	43	63
HCH HCT 80-8T-0.75	834	3.53	2.04	0.55	19600	70	45	65
HCH HCT 80-8T-1	846	4.68	2.70	0.75	22150	71	50	69
HCH HCT 90-4T-4	1734	10.96	6.33	3.00	37750	87	62	90
HCH HCT 90-4/8T-4	1716 / 852		6.50 / 2.30	3.00 / 0.60	37750/18875	87/72	61	88
HCH HCT 90-4T-5.5	1728	14.10	8.12	4.00	41850	89	67	95
HCH HCT 90-4/8T-5.5	1716 / 852		8.20 / 2.90	4.00 / 0.80	41850/20925	89/74	73	101
HCH HCT 90-4T-7.5	1728		11.60	5.50	47000	91	83	109
HCH HCT 90-4/8T-7.5	1740 / 864		11.80 / 3.80	5.50 / 1.10	47000/23500	91/76	93	119
HCH HCT 90-4T-10	1746		14.20	7.50	53000	92	94	120
HCH HCT 90-4T-10	1758		13.90	7.50	53000	92	110	136
HCH HCT 90-4/8T-10	1752 / 870		15.30 / 5.40	7.50 / 1.50	53000/26500	92/77	98	124
HCH HCT 90-6T-2	1146	6.42	3.71	1.50	30000	77	59	87
HCH HCT 90-6/12T-2	1164 / 564		4.60 / 1.90	1.50 / 0.25	30000/15000	77/62	69	97

**Technical characteristics**

Model	Speed (r/min)	Maximum admissible current (A)		Installed power (kW)	Maximum flow rate (m³/h)	Sound pressure level dB(A)	Approx. weight	
		220-277V	380-480V				HCH	HCT
HCH HCT 90-6T-3	1146	9.30	5.30	2.20	35000	78	64	92
HCH HCT 90-6/12T-3	1128 / 564		5.60 / 2.20	2.20 / 0.37	35000/17500	78/63	69	97
HCH HCT 90-6T-4	1152	12.70	7.30	3.00	40000	79	88	114
HCH HCT 90-6/12T-4	1152 / 576		9.00 / 3.50	3.00 / 0.55	40000/20000	79/64	87	113
HCH HCT 90-8T-1	846	4.68	2.70	0.75	22400	71	57	85
HCH HCT 90-8T-1.5	846	5.63	3.25	1.10	24150	72	60	88
HCH HCT 90-8T-2	846	7.10	4.10	1.50	26300	73	71	99
HCH HCT 90-8T-3	846	9.53	5.50	2.20	30150	74	98	124
HCH HCT 100-4T-7,5	1728		11.60	5.50	52500	92	91	121
HCH HCT 100-4/8T-7.5	1740 / 864		11.80 / 3.80	5.50 / 1.10	52500/26250	92/77	101	128
HCH HCT 100-4T-10	1746		14.20	7.50	58500	93	102	131
HCH HCT 100-4T-10	1758		13.90	7.50	58500	93	118	147
HCH HCT 100-4/8T-10	1752 / 870		15.30 / 5.40	7.50 / 1.50	58500/29250	93/78	106	135
HCH HCT 100-4T-15	1752		20.20	11.00	68000	94	125	160
HCH HCT 100-4T-15	1764		20.90	11.00	68000	94	150	185
HCH HCT 100-4/8T-15	1764 / 870		23.20 / 8.70	11.00 / 2.80	68000/34000	94/79	125	160
HCH HCT 100-4T-20	1752		27.50	15.00	71850	95	144	179
HCH HCT 100-4T-20	1758		27.90	15.00	71850	95	161	196
HCH HCT 100-4/8T-20	1752 / 870		31.72 / 11.75	15.00 / 3.80	72450/36225	95/80	140	175
HCH HCT 100-6T-3	1146	9.30	5.30	2.20	40500	82	72	103
HCH HCT 100-6/12T-3	1128 / 564		5.60 / 2.20	2.20 / 0.37	40500/20250	82/67	77	108
HCH HCT 100-6T-4	1152	12.70	7.30	3.00	46950	83	96	125
HCH HCT 100-6/12T-4	1152 / 576		9.00 / 3.50	3.00 / 0.55	46950/23475	83/68	95	124
HCH HCT 100-6T-5.5	1152	16.50	9.46	4.00	52000	84	104	133
HCH HCT 100-6/12T-5.5	1164 / 576		4.00 / 11.00	4.00 / 0.65	52000/26000	84/69	100	129
HCH HCT 100-8T-1.5	846	5.63	3.25	1.10	32500	76	67	99
HCH HCT 100-8T-2	846	7.10	4.10	1.50	33850	77	79	110
HCH HCT 100-8T-3	846	9.53	5.50	2.20	35150	77	106	135
HCH HCT 100-8T-4	846	12.82	7.40	3.00	37800	78	114	143

**Acoustic characteristics**

The indicated values are determined by measuring the sound pressure level and sound power in dB(A) obtained in a free field at a distance equivalent to twice the size of the fan plus the rotor diameter, with a minimum of 1.5 m.

Sound power spectrum Lw(A) in dB(A) per Hz frequency band

Model	63	125	250	500	1000	2000	4000	8000	Model	63	125	250	500	1000	2000	4000	8000
25-2	35	50	69	68	69	68	63	54	71-4-1.5	55	75	83	88	90	87	80	69
25-4	21	36	55	54	55	54	49	40	71-8-1.5 (2v)	40	60	68	73	75	72	65	54
31-2	41	56	75	74	75	74	69	60	71-4-2	56	76	84	89	91	88	81	70
31-4	23	38	57	56	57	56	51	42	71-8-2 (2v)	41	61	69	74	76	73	66	55
35-2	48	63	82	81	82	81	76	67	71-4-3	58	78	86	91	93	90	83	72
35-4	30	45	64	63	64	63	58	49	71-8-3 (2v)	43	63	71	76	78	75	68	57
40-2	55	70	89	88	89	88	83	74	71-4-4	59	79	87	92	94	91	84	73
40-4	35	50	69	68	69	68	63	54	71-8-4 (2v)	44	64	72	77	79	76	69	58
45-2-2	51	68	80	88	93	93	89	82	71-6-0.75	44	64	72	77	79	76	69	58
45-2-3	53	70	82	90	95	95	91	84	71-6-1	45	65	73	78	80	77	70	59
45-4-3 (2v)	38	55	67	75	80	80	76	69	71-12-1 (2v)	30	50	58	63	65	62	55	44
45-4-0.5	33	50	62	70	75	75	71	64	71-6-1.5	46	66	74	79	81	78	71	60
45-6	20	37	49	57	62	62	58	51	71-12-1.5 (2v)	31	51	59	64	66	63	56	45
50-4	37	54	67	74	79	80	75	68	80-4-3	59	79	87	92	94	91	84	73
56-4-0.75	47	67	75	80	82	79	72	61	80-8-3 (2v)	44	64	72	77	79	76	69	58
56-4-1	48	68	76	81	83	80	73	62	80-4-4	60	80	88	93	95	92	85	74
56-8-1 (2v)	33	53	61	66	68	65	58	47	80-8-4 (2v)	45	65	73	78	80	77	70	59
56-4-1.5	49	69	77	82	84	81	74	63	80-4-5.5	61	81	89	94	96	93	86	75
56-8-1.5 (2v)	34	54	62	67	69	66	59	48	80-8-5.5 (2v)	46	66	74	79	81	78	71	60
56-4-2	50	70	78	83	85	82	75	64	80-6-1	48	68	76	81	83	80	73	62
56-8-2 (2v)	35	55	63	68	70	67	60	49	80-12-1 (2v)	33	53	61	66	68	65	58	47
56-6-0.33	36	56	64	69	71	68	61	50	80-6-1.5	49	69	77	82	84	81	74	63
56-6-0.5	36	56	64	69	71	68	61	50	80-12-1.5 (2v)	34	54	62	67	69	66	59	48
56-6-0.75	37	57	65	70	72	69	62	51	80-6-2	50	70	78	83	85	82	75	64
63-4-1	50	70	78	83	85	82	75	64	80-12-2 (2v)	35	55	63	68	70	67	60	49
63-8-1 (2v)	35	55	63	68	70	67	60	49	80-6-3	51	71	79	84	86	83	76	65
63-4-1.5	51	71	79	84	86	83	76	65	80-12-3 (2v)	36	56	64	69	71	68	61	50
63-8-1.5 (2v)	36	56	64	69	71	68	61	50	80-8-0.5	46	66	74	79	81	78	71	60
63-4-2	52	72	80	85	87	84	77	66	80-8-0.75	47	67	75	80	82	79	72	61
63-8-2 (2v)	37	57	65	70	72	69	62	51	80-8-1	48	68	76	81	83	80	73	62
63-4-3	53	73	81	86	88	85	78	67	80-4-4	65	86	93	98	101	97	90	79
63-8-3 (2v)	38	58	66	71	73	70	63	52	90-8-4 (2v)	50	71	78	83	86	82	75	64
63-4-4	54	74	82	87	89	86	79	68	90-4-5.5	67	88	95	100	103	99	92	81
63-8-4 (2v)	39	59	67	72	74	71	64	53	90-8-5.5 (2v)	52	73	80	85	88	84	77	66
63-6-0.5	41	61	69	74	76	73	66	55	90-4-7.5	69	90	97	102	105	101	94	83
63-6-0.75	42	62	70	75	77	74	67	56	90-8-7.5 (2v)	54	75	82	87	90	86	79	68
63-6-1	43	63	71	76	78	75	68	57	90-4-10	70	91	98	103	106	102	95	84
63-12-1 (2v)	28	48	56	61	63	60	53	42	90-8-10 (2v)	55	76	83	88	91	87	80	69

### Acoustic characteristics

The indicated values are determined by measuring the sound pressure level and sound power in dB(A) obtained in a free field at a distance equivalent to twice the size of the fan plus the rotor diameter, with a minimum of 1.5 m.

Sound power spectrum Lw(A) in dB(A) per Hz frequency band

Model	63	125	250	500	1000	2000	4000	8000	Model	63	125	250	500	1000	2000	4000	8000
90-6-2	55	76	83	88	91	87	80	69	100-4-15	74	94	102	107	109	106	99	88
90-12-2 (2v)	40	61	68	73	76	72	65	54	100-8-15 (2v)	59	79	87	92	94	91	84	73
90-6-3	56	77	84	89	92	88	81	70	100-4-20	75	95	103	108	110	107	100	89
90-12-3 (2v)	41	62	69	74	77	73	66	55	100-8-20 (2v)	60	80	88	93	95	92	85	74
90-6-4	57	78	85	90	93	89	82	71	100-6-3	62	82	90	95	97	94	87	76
90-12-4 (2v)	42	63	70	75	78	74	67	56	100-12-3 (2v)	47	67	75	80	82	79	72	61
90-8-1	49	70	77	82	85	81	74	63	100-6-4	63	83	91	96	98	95	88	77
90-8-1.5	50	71	78	83	86	82	75	64	100-12-4 (2v)	48	68	76	81	83	80	73	62
90-8-2	51	72	79	84	87	83	76	65	100-6-5.5	64	84	92	97	99	96	89	78
90-8-3	52	73	80	85	88	84	77	66	100-12-5.5 (2v)	49	69	77	82	84	81	74	63
100-4-7.5	72	92	100	105	107	104	97	86	100-8-1.5	56	76	84	89	91	88	81	70
100-8-7.5 (2v)	57	77	85	90	92	89	82	71	100-8-2	57	77	85	90	92	89	82	71
100-4-10	73	93	101	106	108	105	98	87	100-8-3	57	77	85	90	92	89	82	71
100-8-10 (2v)	58	78	86	91	93	90	83	72	100-8-4	58	78	86	91	93	90	83	72

### Dimensions mm

#### HCH

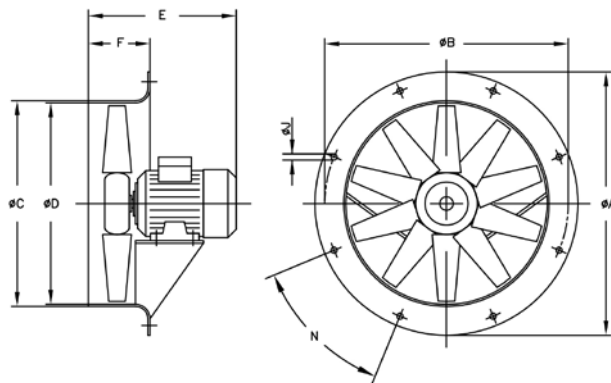

Model	ØA	ØB	ØC	ØD	E																F	ØJ	N
					0.16	0.33	0.5	0.75	1	1.5	2	3	4	5.5	7.5	10	15	20					
HCH-35-2	425	395	358	355	-	-	285	-	-	-	-	-	-	-	-	-	-	-	110	10	8x45°		
HCH-35-4	425	395	358	355	257	-	-	-	-	-	-	-	-	-	-	-	-	-	110	10	8x45°		
HCH-40-2	490	450	414	410	-	-	-	-	-	314	-	-	-	-	-	-	-	-	120	12	8x45°		
HCH-40-4	490	450	414	410	-	305	-	-	-	-	-	-	-	-	-	-	-	-	120	12	8x45°		
HCH-45-4	540	500	464	460	-	-	295	-	-	-	-	-	-	-	-	-	-	-	120	12	8x45°		
HCH-45-6	540	500	464	460	-	295	-	-	-	-	-	-	-	-	-	-	-	-	120	12	8x45°		
HCH-56-4	660	620	564	560	-	-	-	316	316	330	354	-	-	-	-	-	-	-	120	12	12x30°		
HCH-56-6	660	620	564	560	-	298	316	316	-	-	-	-	-	-	-	-	-	-	120	12	12x30°		
HCH-63-4	730	690	645	640	-	-	-	-	332	340	366	420	420	-	-	-	-	-	150	12	12x30°		
HCH-63-6	730	690	645	640	-	-	332	332	340	-	-	-	-	-	-	-	-	-	150	12	12x30°		
HCH-71-4	810	770	715	710	-	-	-	-	-	334	360	430	430	-	-	-	-	-	150	12	16x22°30'		
HCH-71-6	810	770	715	710	-	-	-	323	334	360	-	-	-	-	-	-	-	-	150	12	16x22°30'		
HCH-80-4	900	860	805	800	-	-	-	-	-	-	-	425	425	445	-	-	-	-	180	12	16x22°30'		
HCH-80-6	900	860	805	800	-	-	-	-	360	386	425	445	-	-	-	-	-	-	180	12	16x22°30'		
HCH-80-8	900	860	805	800	-	-	380	386	410	-	-	-	-	-	-	-	-	-	180	12	16x22°30'		
HCH-90-4	1015	970	906	900	-	-	-	-	-	-	-	436	430	465	465	-	-	-	180	12	16x22°30'		
HCH-90-6	1015	970	906	900	-	-	-	-	-	-	436	430	465	-	-	-	-	-	180	12	16x22°30'		
HCH-90-8	1015	970	906	900	-	-	-	-	436	436	430	460	-	-	-	-	-	-	180	12	16x22°30'		
HCH-100-4	1115	1070	1006	1000	-	-	-	-	-	-	-	-	-	503	503	612	612	200	15	16x22°30'			
HCH-100-6	1115	1070	1006	1000	-	-	-	-	-	-	440	503	503	-	-	-	-	-	200	15	16x22°30'		
HCH-100-8	1115	1070	1006	1000	-	-	-	-	433	440	503	503	-	-	-	-	-	-	200	15	16x22°30'		



Dimensions mm

HCT

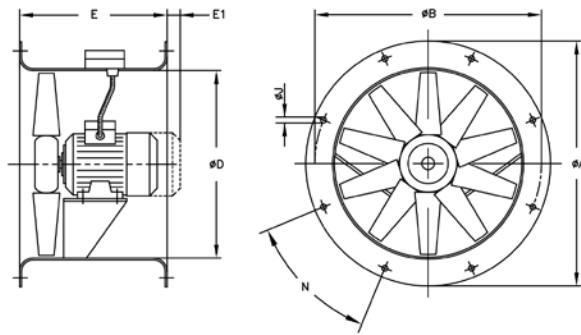

Model	ØA	ØB	ØD	E	E1	ØJ	N
HCT-25	310	280	240	230	10	10	4x90°
HCT-31	350	320	280	270	-	10	4x90°
HCT-35	425	395	355	280	-	10	8x45°
HCT-40	490	450	410	320	-	12	8x45°
HCT-45	540	500	460	360	-	12	8x45°
HCT-50	600	560	514	360	-	12	12x30°
HCT-56	660	620	560	400	-	12	12x30°
HCT-63	730	690	640	430	-	12	12x30°
HCT-71	810	770	710	500	-	12	16x22°30'
HCT-80	900	860	800	500	-	12	16x22°30'
HCT-90	1015	970	900	500	-	15	16x22°30'
HCT-100	1115	1070	1000	600	-	15	16x22°30'
HCT-100-4T-15	1115	1070	1000	700	-	15	16x22°30'
HCT-100-4T-20	1115	1070	1000	700	-	15	16x22°30'

Characteristic curves

Q= Flow rate in m³/h, m³/s and cfm.

Pe= Static pressure in mm H<sub>2</sub>O, Pa and inwg.

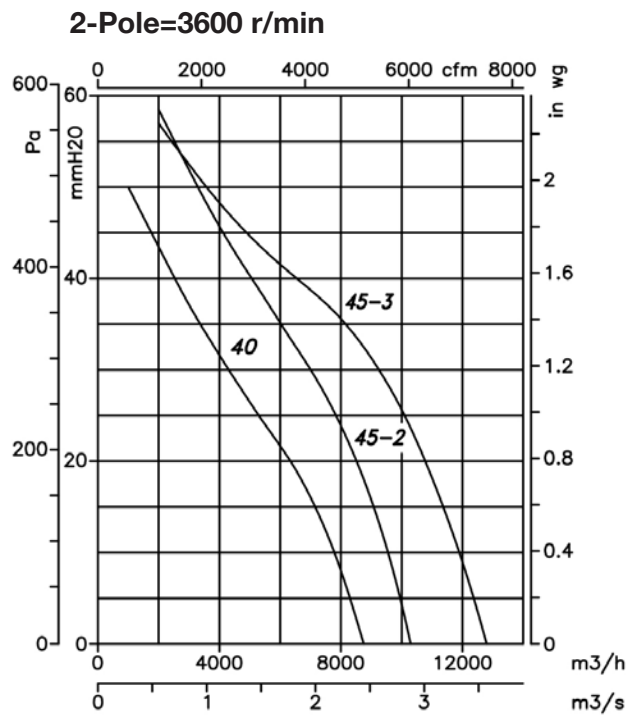
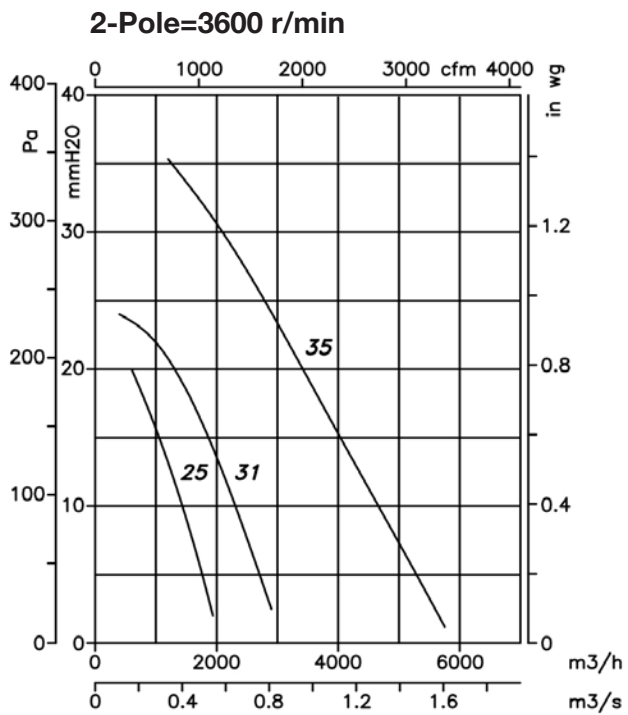

**Characteristic curves**

Q= Flow rate in m<sup>3</sup>/h, m<sup>3</sup>/s and cfm.

Pe= Static pressure in mm H<sub>2</sub>O, Pa and inwg.

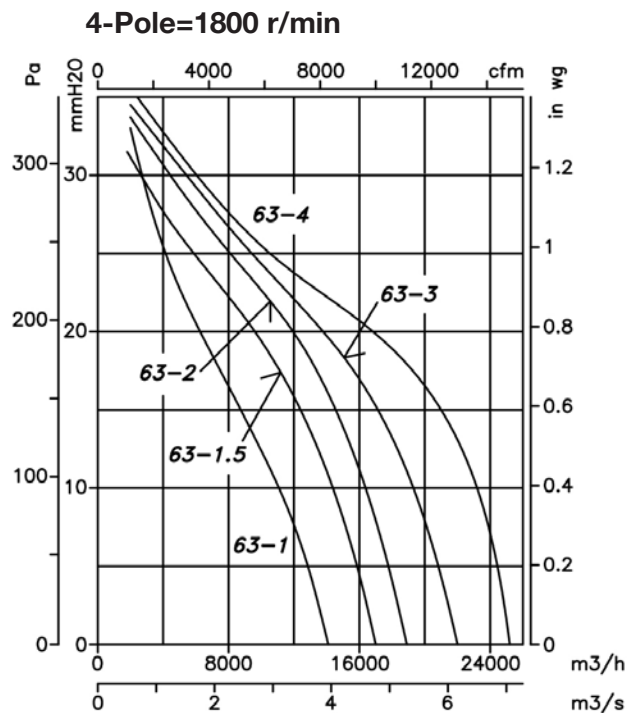
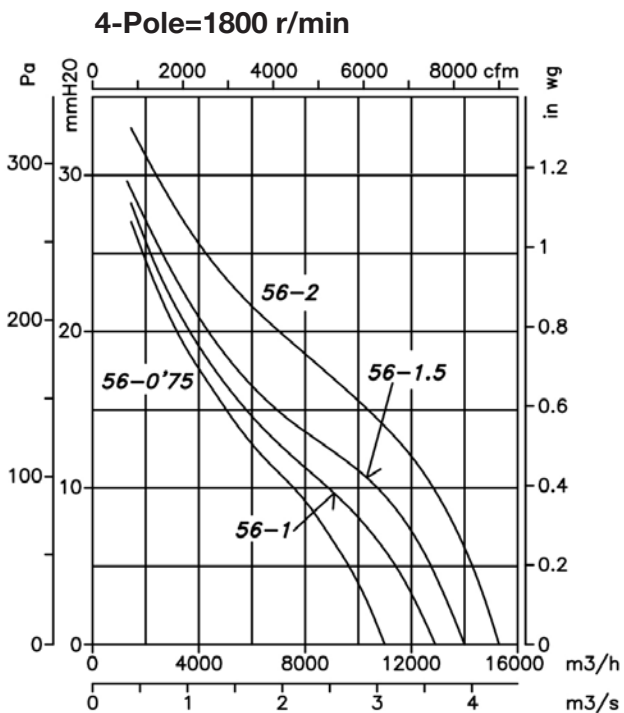
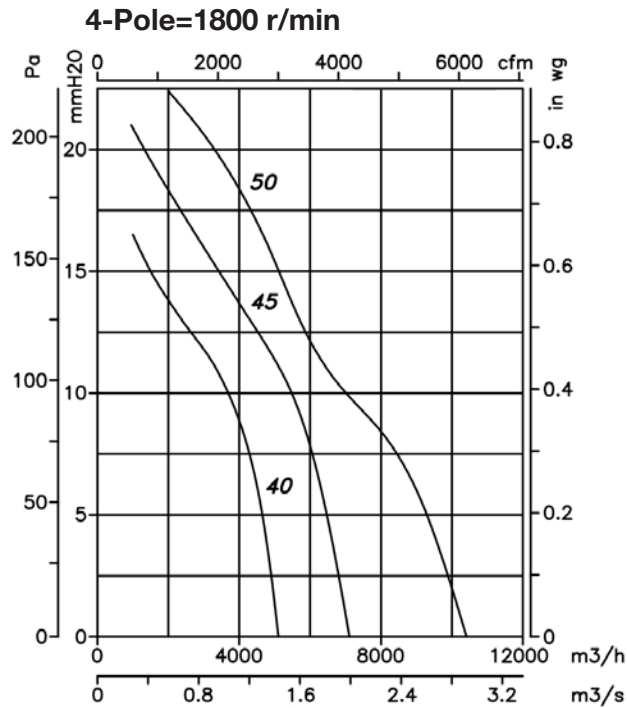
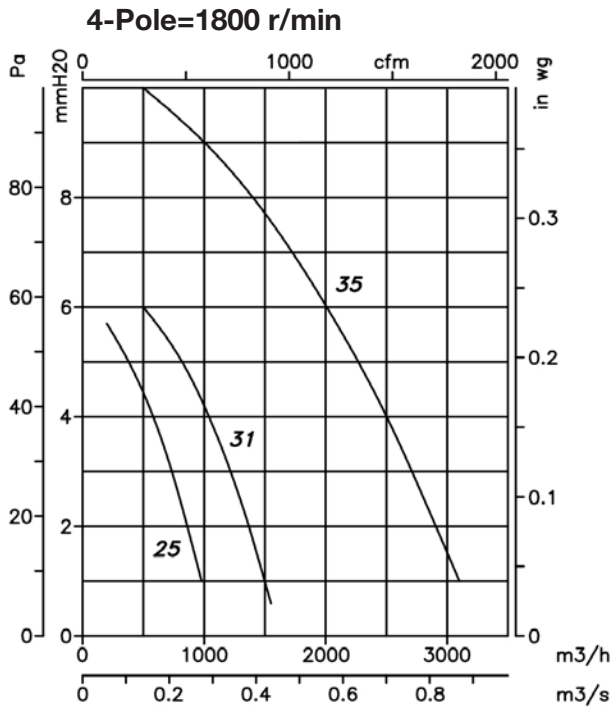

**Characteristic curves**

Q= Flow rate in m<sup>3</sup>/h, m<sup>3</sup>/s and cfm.

Pe= Static pressure in mm H<sub>2</sub>O, Pa and inwg.

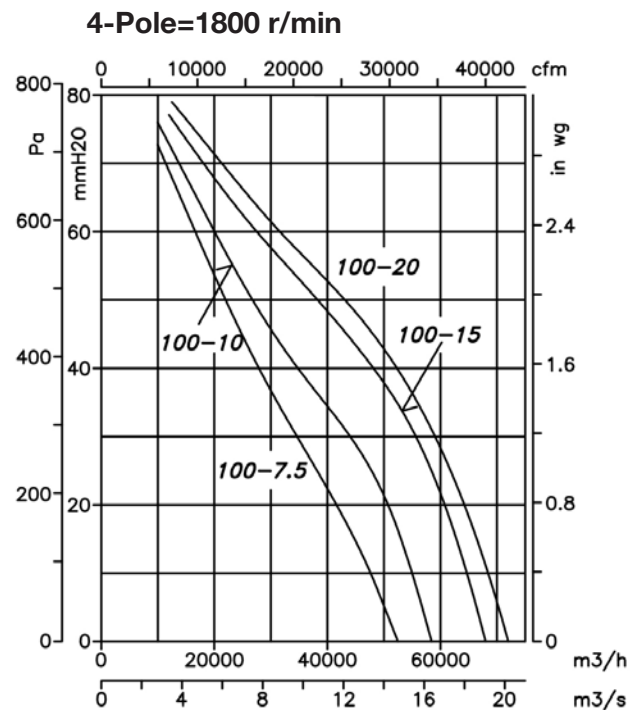
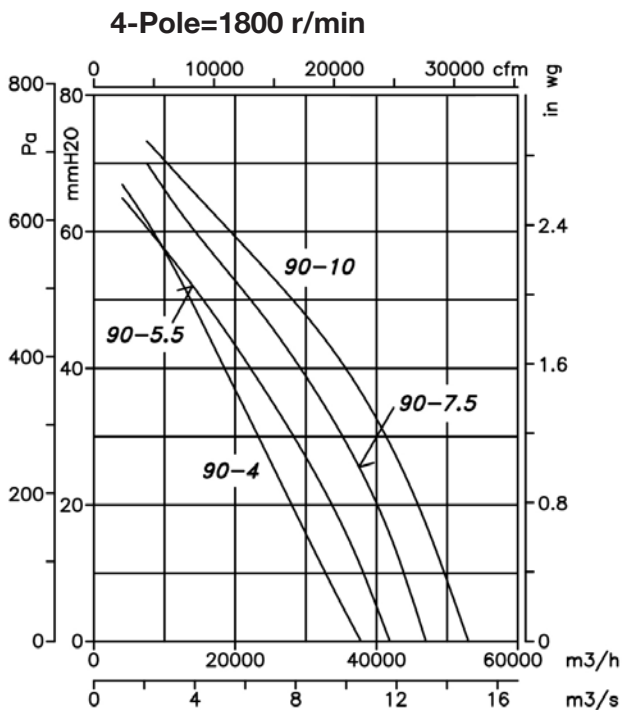
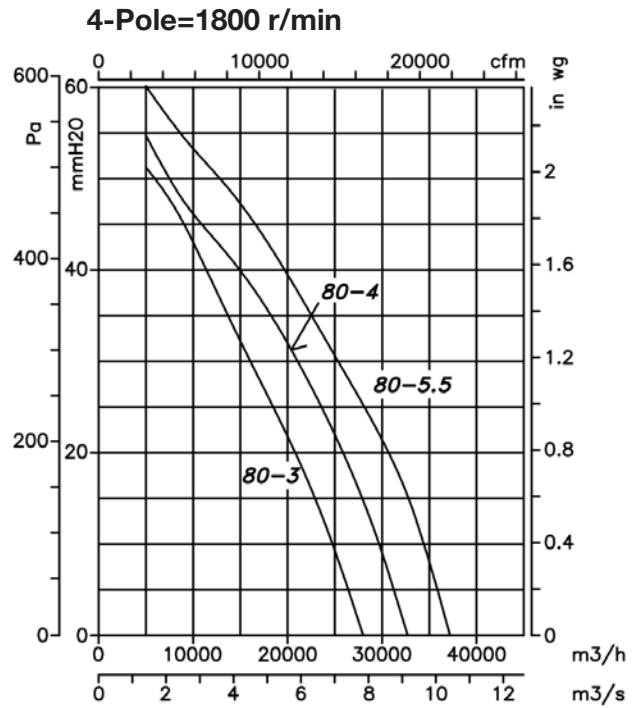
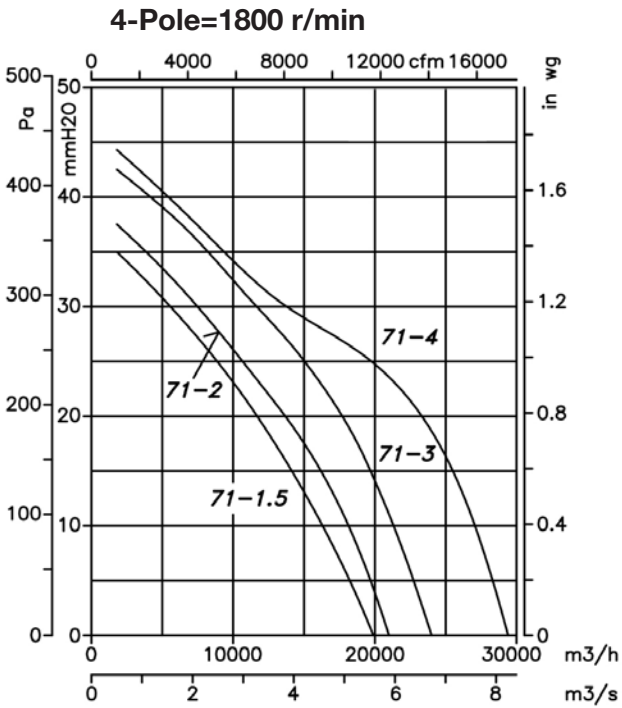

**Characteristic curves**

Q= Flow rate in m<sup>3</sup>/h, m<sup>3</sup>/s and cfm.

Pe= Static pressure in mm H<sub>2</sub>O, Pa and inwg.

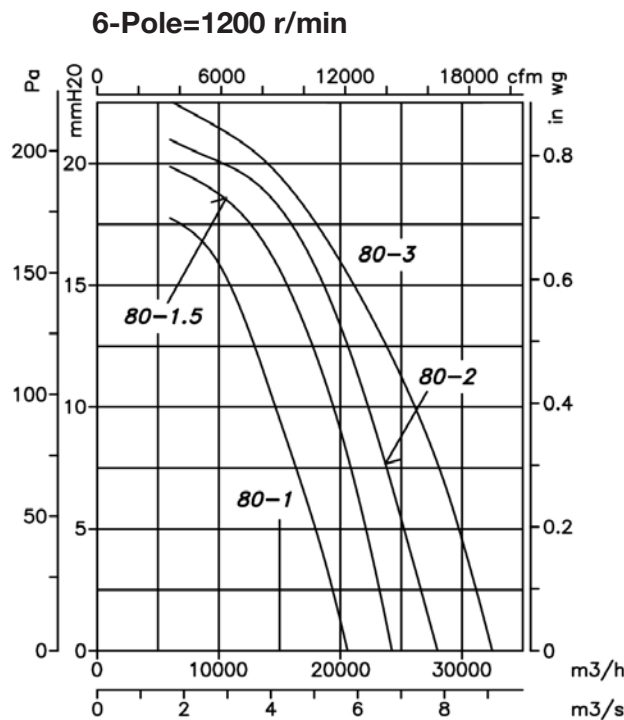
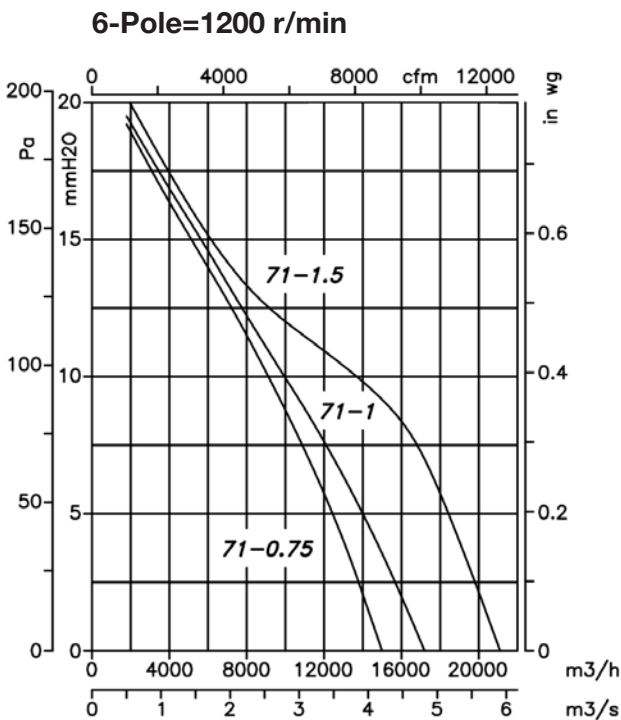
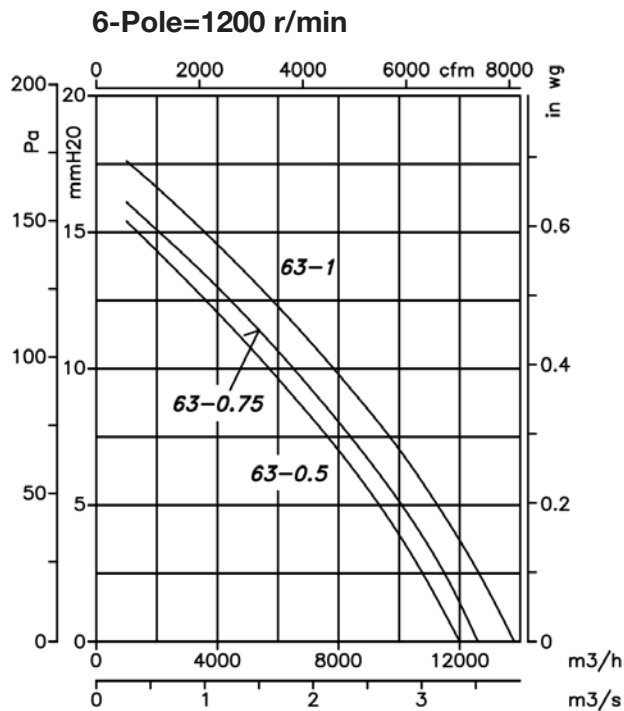
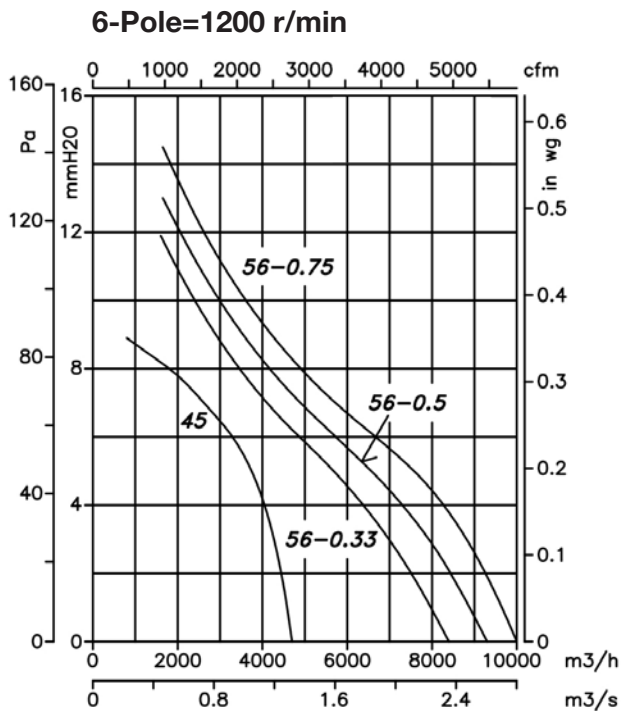

**Characteristic curves**

Q= Flow rate in m<sup>3</sup>/h, m<sup>3</sup>/s and cfm.

Pe= Static pressure in mm H<sub>2</sub>O, Pa and inwg.

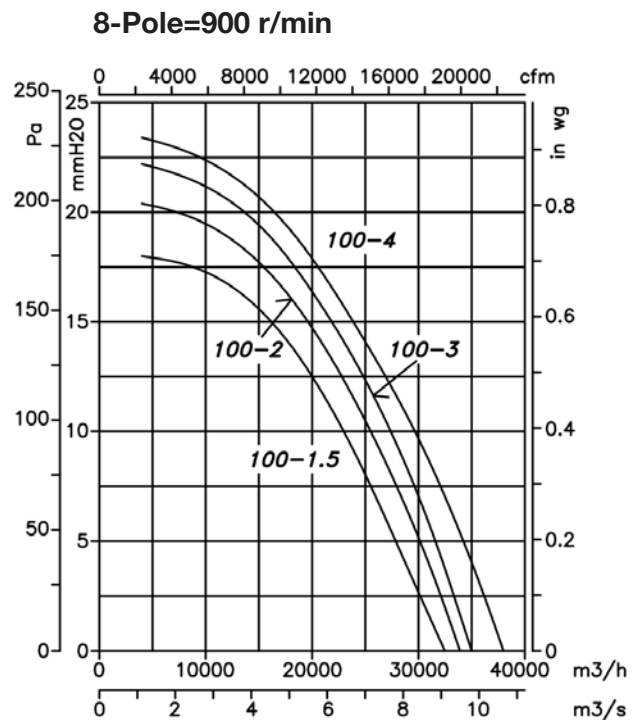
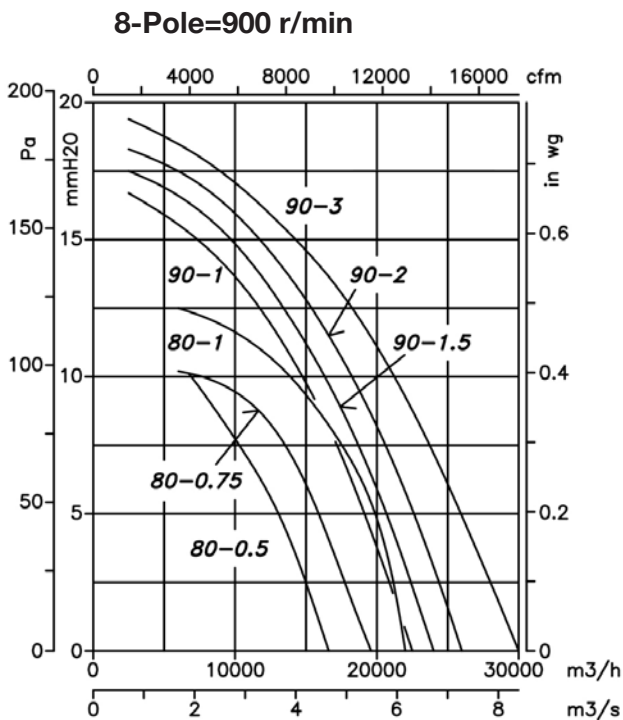
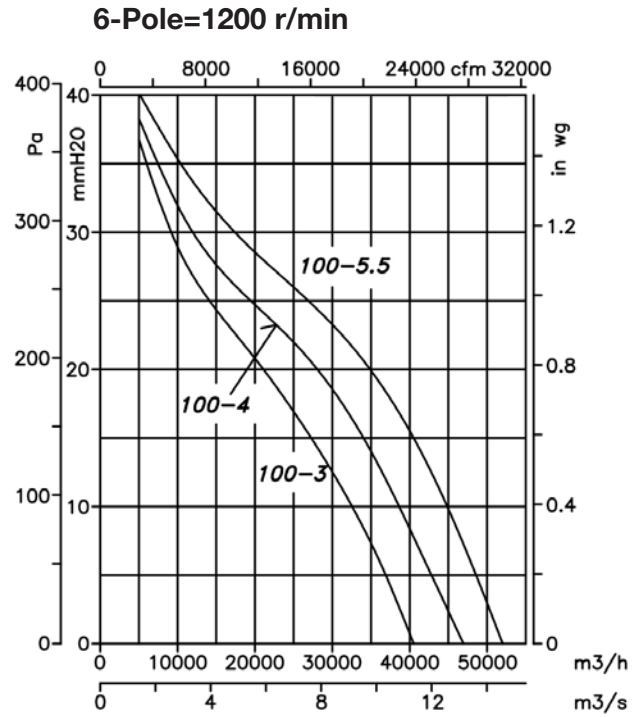
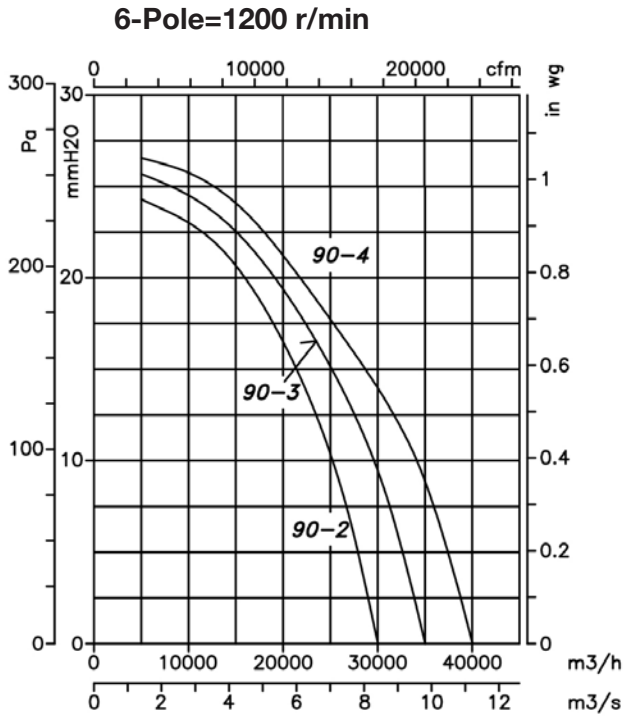

**Characteristic curves**

Q= Flow rate in m<sup>3</sup>/h, m<sup>3</sup>/s and cfm.

Pe= Static pressure in mm H<sub>2</sub>O, Pa and inwg.

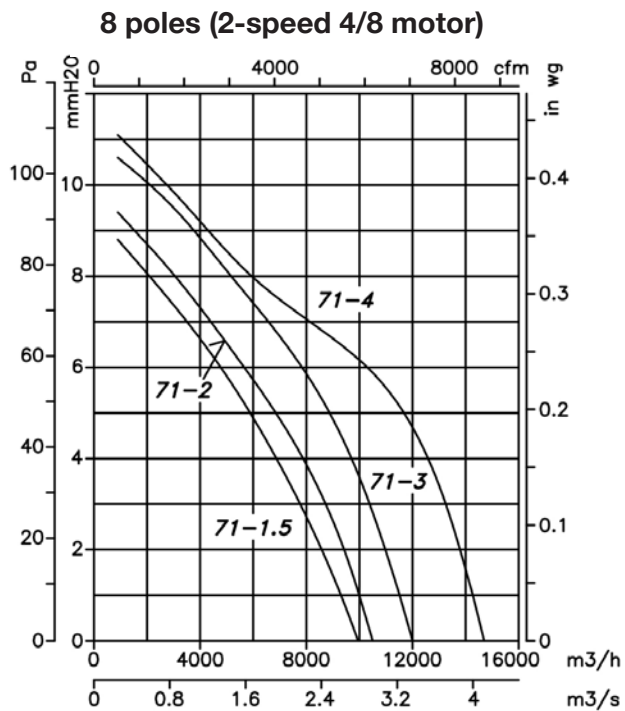
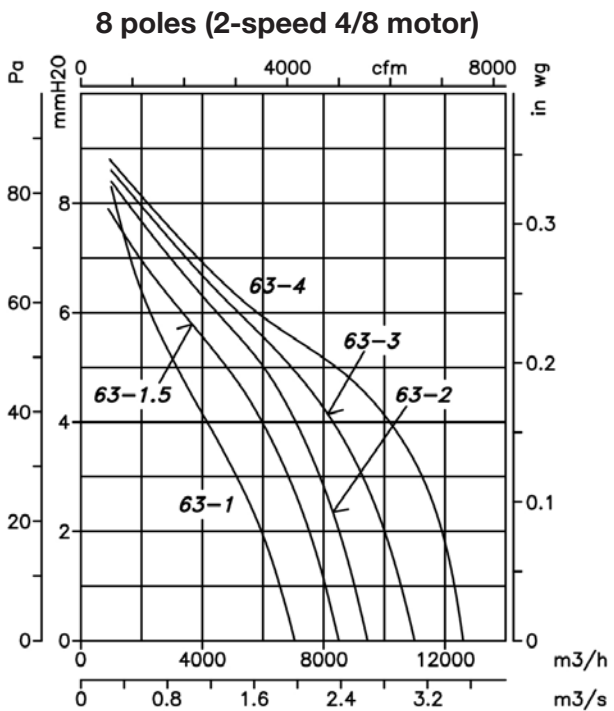
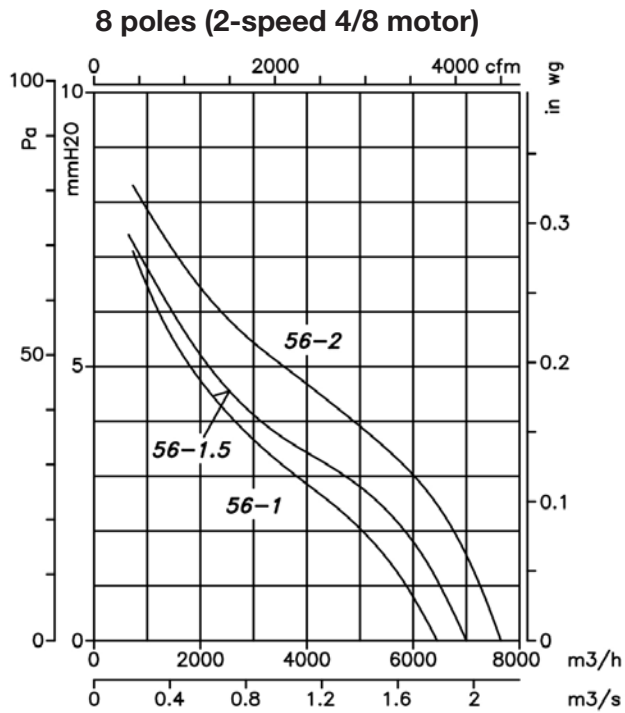
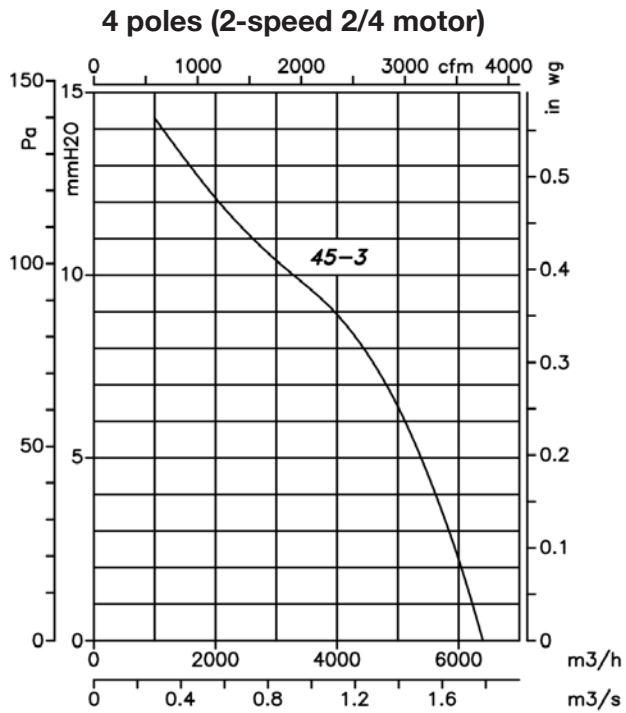

**Characteristic curves**

Q= Flow rate in m<sup>3</sup>/h, m<sup>3</sup>/s and cfm.

Pe= Static pressure in mm H<sub>2</sub>O, Pa and inwg.

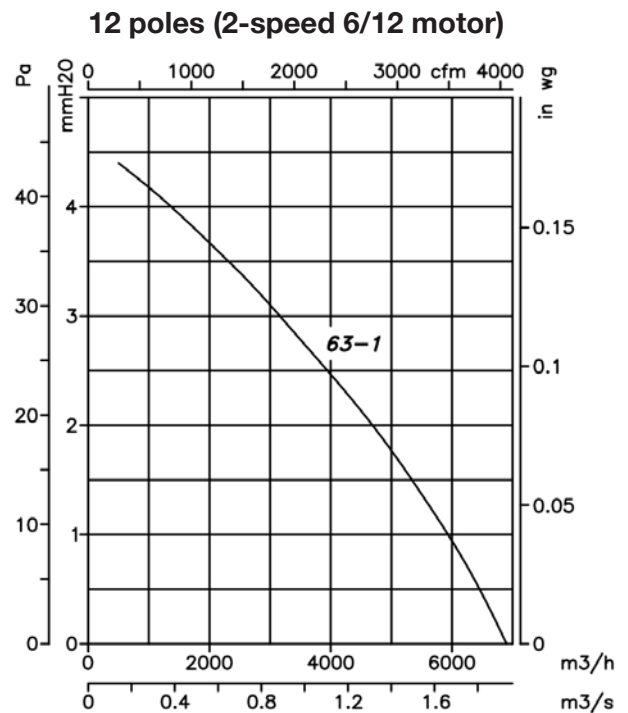
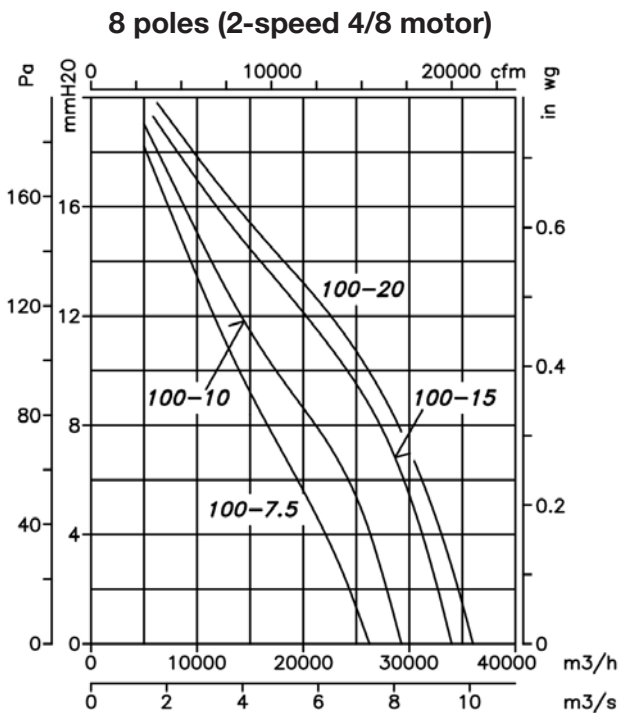
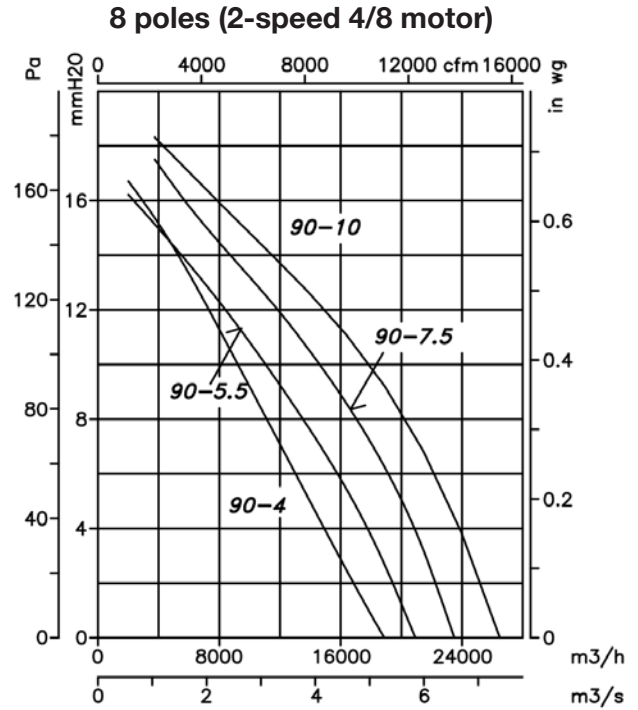
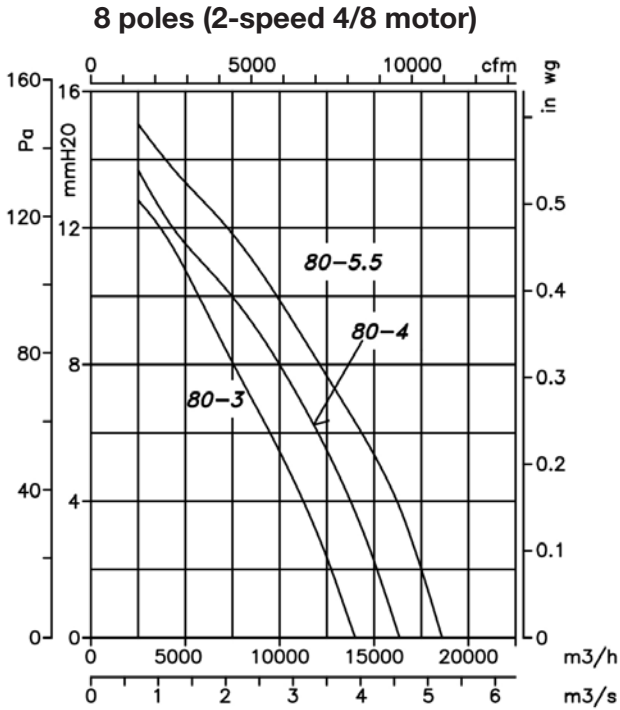

**Characteristic curves**

Q= Flow rate in m<sup>3</sup>/h, m<sup>3</sup>/s and cfm.

Pe= Static pressure in mm H<sub>2</sub>O, Pa and inwg.

**12 poles (2-speed 6/12 motor)**

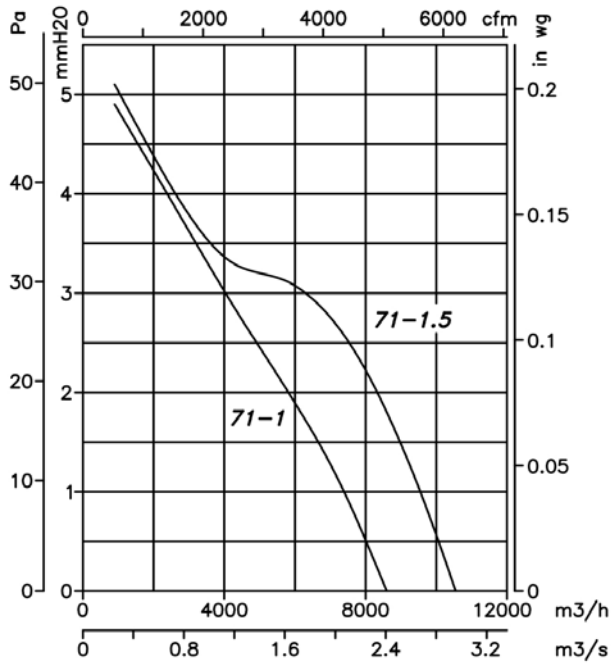

**12 poles (2-speed 6/12 motor)**

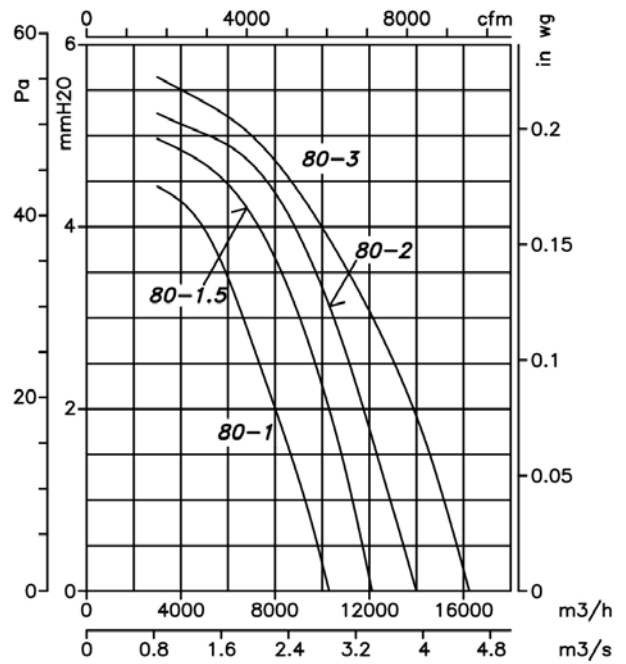

**12 poles (2-speed 6/12 motor)**

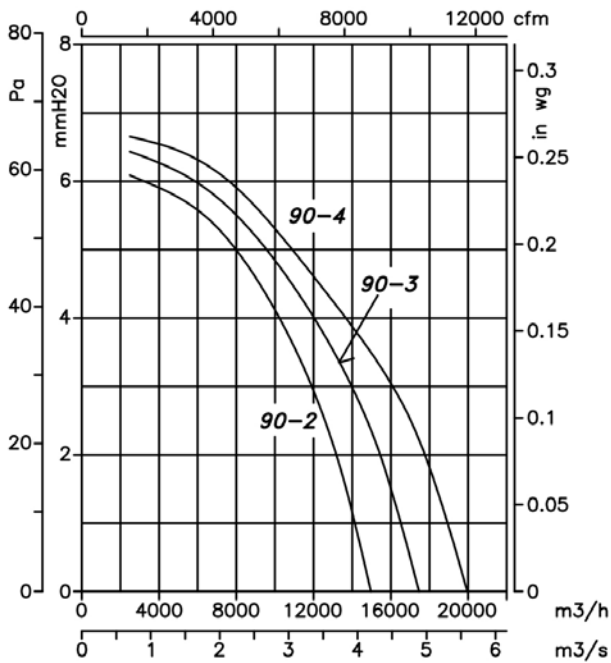

**12 poles (2-speed 6/12 motor)**

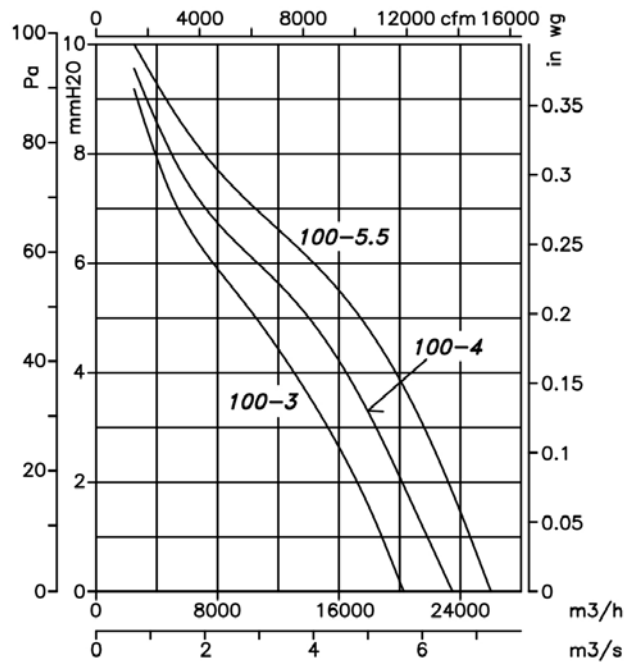

**Accessories**

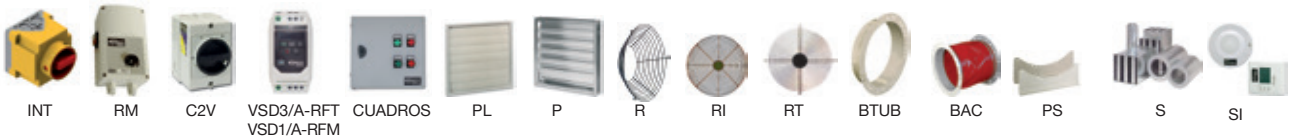





### Technical characteristics

Model	Speed (r/min)	Maximum admissible current (A)		Installed capacity (kW)	Maximum airflow (m³/h)	Sound pres- sure level dB(A)	Approx. weight (Kg)
		220-277 V	380-480 V				
CJHCH-71-4T-3	1722	7,93	4,56	2,20	23950	78	89,3
CJHCH-71-4/8T-3	1716 / 852		4,90 / 1,70	2,20 / 0,45	24150/12075	78 / 63	86,3
CJHCH-71-4T-4	1728	10,70	6,15	3,00	29400	79	91,3
CJHCH-71-4/8T-4	1716 / 852		6,50 / 2,30	3,00 / 0,60	29550/14775	79 / 64	89,7
CJHCH-71-6T-0.75	1080	2,99	1,73	0,55	15150	65	73,2
CJHCH-71-6M-0.75	1080	3,84		0,55	15150	65	73,2
CJHCH-71-6T-1	1128	3,36	1,93	0,75	17250	66	80,3
CJHCH-71-6T-1.5	1134	4,68	2,69	1,10	20950	67	82,3
CJHCH-80-4T-3	1722	7,93	4,56	2,20	28000	79	97,3
CJHCH-80-4/8T-3	1716 / 852		4,90 / 1,70	2,20 / 0,45	28000/14000	79 / 64	94,3
CJHCH-80-4T-4	1728	10,70	6,15	3,00	32700	80	99,3
CJHCH-80-4/8T-4	1716 / 852		6,50 / 2,30	3,00 / 0,60	32700/16350	80 / 65	97,7
CJHCH-80-4T-5.5	1740	13,90	8,00	4,00	37200	81	104,2
CJHCH-80-4/8T-5.5	1716 / 852		8,20 / 2,90	4,00 / 0,80	37200/18600	81 / 66	110,2
CJHCH-80-6T-1	1128	3,36	1,93	0,75	20600	69	88,3
CJHCH-80-6T-1.5	1134	4,68	2,69	1,10	24250	70	90,3
CJHCH-80-6T-2	1140	6,43	3,70	1,50	28000	71	96,3
CJHCH-80-6T-3	1140	9,08	5,22	2,20	32500	72	101,2
CJHCH-90-4T-4	1728	10,70	6,15	3,00	37750	84	123,2
CJHCH-90-4/8T-4	1716 / 852		6,50 / 2,30	3,00 / 0,60	37750/18875	84 / 69	121,6
CJHCH-90-4T-5.5	1740	13,90	8,00	4,00	41850	86	128,1
CJHCH-90-4/8T-5.5	1716 / 852		8,20 / 2,90	4,00 / 0,80	41850/20925	86 / 71	134,1
CJHCH-90-4T-7.5	1758		10,30	5,50	47000	88	143,5
CJHCH-90-4/8T-7.5	1740 / 864		11,80 / 3,80	5,50 / 1,10	47000/23500	88 / 73	153,5
CJHCH-90-4T-10	1758		13,90	7,50	53000	89	154,5
CJHCH-90-4/8T-10	1752 / 870		15,30 / 5,40	7,50 / 1,50	53000/26500	89 / 74	158,5
CJHCH-90-6T-2	1140	6,43	3,70	1,50	30000	75	120,2
CJHCH-90-6T-3	1140	9,08	5,22	2,20	35000	76	125,1
CJHCH-90-6T-4	1164	12,00	6,91	3,00	40000	77	148,5
CJHCH-100-4T-7.5	1758		10,30	5,50	52500	89	152,1
CJHCH-100-4/8T-7.5	1740 / 864		11,80 / 3,80	5,50 / 1,10	52500/26250	89 / 74	162,1
CJHCH-100-4T-10	1758		13,90	7,50	58500	90	163,1
CJHCH-100-4/8T-10	1752 / 870		15,30 / 5,40	7,50 / 1,50	58500/29250	90 / 75	167,1
CJHCH-100-4T-15	1764		20,90	11,00	68000	91	185,7
CJHCH-100-4/8T-15	1764 / 870		23,20 / 8,70	11,00 / 2,80	68000/34000	91 / 76	185,7
CJHCH-100-4T-20	1758		27,90	15,00	71850	92	204,7
CJHCH-100-4/8T-20	1752 / 870		31,72 / 11,75	15,00 / 3,80	72450/36225	92 / 77	200,7
CJHCH-100-6T-3	1140	9,08	5,22	2,20	40500	80	133
CJHCH-100-6T-4	1164	12,00	6,91	3,00	46950	81	157,1
CJHCH-100-6T-5.5	1152	15,60	8,99	4,00	52000	82	165,1

### Acoustic features

The specified values are determined according to free field measurements of pressure and sound levels in dB(A) at an equivalent distance of twice the fan's span plus the impeller's diameter, with a minimum of 1.5 m.

Espectro de potencia sonora Lw(A) en dB(A) por banda de frecuencia en Hz

Model	63	125	250	500	1000	2000	4000	8000	Model	63	125	250	500	1000	2000	4000	8000
56-4-0.75	44	64	72	77	79	76	69	58	71-8-1.5 (2v)	37	57	65	70	72	69	62	51
56-4-1	45	65	73	78	80	77	70	59	71-4-2	53	73	81	86	88	85	78	67
56-8-1 (2v)	30	50	58	63	65	62	55	44	71-8-2 (2v)	38	58	66	71	73	70	63	52
56-4-1.5	46	66	74	79	81	78	71	60	71-4-3	55	75	83	88	90	87	80	69
56-8-1.5 (2v)	31	51	59	64	66	63	56	45	71-8-3 (2v)	40	60	68	73	75	72	65	54
56-4-2	47	67	75	80	82	79	72	61	71-4-4	56	76	84	89	91	88	81	70
56-6-0.33	34	54	62	67	69	66	59	48	71-8-4 (2v)	41	61	69	74	76	73	66	55
56-6-0.5	34	54	62	67	69	66	59	48	71-6-0.75	42	62	70	75	77	74	67	56
56-6-0.75	35	55	63	68	70	67	60	49	71-6-1	43	63	71	76	78	75	68	57
63-4-1	47	67	75	80	82	79	72	61	71-6-1.5	44	64	72	77	79	76	69	58
63-8-1 (2v)	32	52	60	65	67	64	57	46	80-4-3	56	76	84	89	91	88	81	70
63-4-1.5	48	68	76	81	83	80	73	62	80-8-3 (2v)	41	61	69	74	76	73	66	55
63-8-1.5 (2v)	33	53	61	66	68	65	58	47	80-4-4	57	77	85	90	92	89	82	71
63-4-2	49	69	77	82	84	81	74	63	80-8-4 (2v)	42	62	70	75	77	74	67	56
63-8-2 (2v)	34	54	62	67	69	66	59	48	80-4-5.5	58	78	86	91	93	90	83	72
63-4-3	50	70	78	83	85	82	75	64	80-8-5.5 (2v)	43	63	71	76	78	75	68	57
63-8-3 (2v)	35	55	63	68	70	67	60	49	80-6-1	46	66	74	79	81	78	71	60
63-4-4	51	71	79	84	86	83	76	65	80-6-1.5	47	67	75	80	82	79	72	61
63-8-4 (2v)	36	56	64	69	71	68	61	50	80-6-2	48	68	76	81	83	80	73	62
63-6-0.5	39	59	67	72	74	71	64	53	80-6-3	49	69	77	82	84	81	74	63
63-6-0.75	40	60	68	73	75	72	65	54	90-4-4	62	83	90	95	98	94	87	76
63-6-1	41	61	69	74	76	73	66	55	90-8-4 (2v)	47	68	75	80	83	79	72	61
71-4-1.5	52	72	80	85	87	84	77	66	90-4-5.5	64	85	92	97	100	96	89	78

**Acoustic features**

Model	63	125	250	500	1000	2000	4000	8000	Model	63	125	250	500	1000	2000	4000	8000
90-8-5.5 (2v)	49	70	77	82	85	81	74	63	100-4-10	70	90	98	103	105	102	95	84
90-4-7.5	66	87	94	99	102	98	91	80	100-8-10 (2v)	55	75	83	88	90	87	80	69
90-8-7.5 (2v)	51	72	79	84	87	83	76	65	100-4-15	71	91	99	104	106	103	96	85
90-4-10	67	88	95	100	103	99	92	81	100-8-15 (2v)	56	76	84	89	91	88	81	70
90-8-10 (2v)	52	73	80	85	88	84	77	66	100-4-20	72	92	100	105	107	104	97	86
90-6-2	53	74	81	86	89	85	78	67	100-8-20 (2v)	57	77	85	90	92	89	82	71
90-6-3	54	75	82	87	90	86	79	68	100-6-3	60	80	88	93	95	92	85	74
90-6-4	55	76	83	88	91	87	80	69	100-6-4	61	81	89	94	96	93	86	75
100-4-7.5	69	89	97	102	104	101	94	83	100-6-5.5	62	82	90	95	97	94	87	76
100-8-7.5 (2v)	54	74	82	87	89	86	79	68									

**Dimensions in mm**

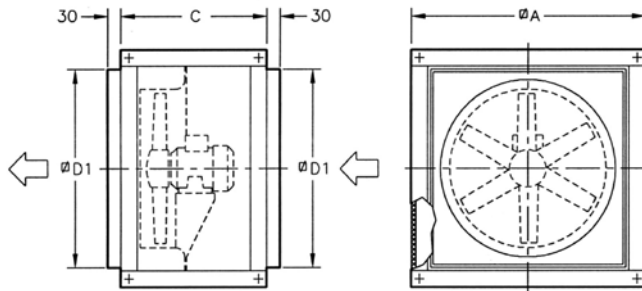

Model	∅A	C	∅D1
CJHCH-56/63	825	550	690
CJHCH-71/80	1000	650	850
CJHCH-90/100	1200	750	1050

**Characteristic curves and efficiency data**

See characteristic curves on HCH-HCT series

**Accessories**

See accessories section.



# HCT/IMP-C

Long-range, circular, one-way or reversible jet fans



Deflector for increasing range

Long range one-way or reversible jet fans with a circular design for air movement and CO extraction in car parks.

#### Fan:

- One-way or reversible fan unit formed by a fan, silencers, deflectors and supports.
- Adjustable rotors designed to produce great thrusts.
- Anti-contact protective grille pursuant to standard UNE-EN ISO 12499.
- Deflector to increase the air range on the impulsion side. Reversible models are fitted with deflectors on both sides.
- High attenuation silencers with thermal and acoustic insulation.
- Air direction from Motor to Impeller or 100 % reversible.
- Circular casing in painted sheet steel.

#### Motor:

- Class F motors with ball bearings, IP55 protection and with 1 or 2 speeds, depending on model.
- Three-phase 380-440V. 60Hz.
- Maximum temperature of air to be carried: -20 °C +40 °C.

with phosphate-free nanotechnological treatment.

#### On request:

#### Finish:

- Anti-corrosive finish of polyester resin polymerised at 190 °C, previously degreased

- Thrust features different from those indicated.
- Version approved for smoke evacuation in accordance with standard EN 12101-3 (see THT/IMP series).
- INT series safety switch built into the fan.

## Order code

<b>HCT/IMP-C</b>	—	<b>UNI</b>	—	<b>38</b>	—	<b>2/4T</b>	—	<b>1.5</b>	—	<b>60Hz</b>
↓		↓		↓		↓		↓		
HCT/IMP: Long-range, circular, one-way or reversible jet fans		Airflow direction UNI: One-way REV: Reversible		Rotor diameter in cm		Number of motor poles 2=3500 r/min. 60 Hz 4=1680 r/min. 60 Hz 6=1080 r/min. 60 Hz 8=900 r/min. 60 Hz 12=750 r/min. 60 Hz		T=Three-phase Motor power (hp)		

## Technical characteristics

60Hz

Model	Speed (r/min)	Maximum current (A)		Flow rate (m <sup>3</sup> /h)	Thrust (N)	Speed impulsion (m/s)	Installed power (kW)	Sound pressure LpA at 10m dB(A)	Approx. weight (kg)
		220-254 V	380-440 V						
<b>One-way</b>									
HCT/IMP-C-UNI-40-4T-0.33	1620	1.66	0.96	5150	19	10.8	0.25	38	88
HCT/IMP-C-UNI-45-4T-0.5	1644	2.02	1.17	7100	28	11.9	0.37	43	120
HCT/IMP-C-UNI-50-4T-0.75	1656	2.92	1.69	10300	47	13.8	0.55	47	186
HCT/IMP-C-UNI-31-2/4T	3432 / 1716		1.50 / 0.55	4260 / 2130	21/ 5	15.6 / 7.8	0.55 / 0.15	51 / 36	65
HCT/IMP-C-UNI-35-2/4T	3450 / 1716		2.10 / 0.80	6360 / 3180	36/ 9	17.8 / 8.9	0.85 / 0.20	52 / 37	70
HCT/IMP-C-UNI-38-2/4T-1.5	3480 / 1740		2.90 / 1.10	8450 / 4225	57/ 15	20.7 / 10.3	1.10 / 0.25	47 / 32	89
HCT/IMP-C-UNI-40-2/4T-1.5	3480 / 1740		2.90 / 1.10	9250 / 4625	60/ 15	20.4 / 10.2	1.10 / 0.25	53 / 38	98
HCT/IMP-C-UNI-45-2/4T-2	3528 / 1752		4.40 / 1.40	10800 / 5400	62/ 15	18.1 / 9.0	1.50 / 0.37	57 / 42	132
HCT/IMP-C-UNI-45-2/4T-3	3516 / 1740		5.70 / 1.80	13200 / 6600	92/ 23	22.1 / 11.0	2.20 / 0.60	58 / 43	133
HCT/IMP-C-UNI-50-2/4T-6	3516 / 1740		10.00 / 3.20	19700 / 9850	165/ 41	26.4 / 13.2	4.50 / 1.30	60 / 45	220
<b>Reversible</b>									
HCT/IMP-C-REV-40-4T-0.33	1620	1.66	0.96	4895	17	10.3	0.25	37	90
HCT/IMP-C-REV-45-4T-0.5	1644	2.02	1.17	6745	25	11.3	0.37	42	120
HCT/IMP-C-REV-50-4T-0.75	1656	2.92	1.69	9785	43	13.1	0.55	46	233
HCT/IMP-C-REV-31-2/4T	3432 / 1716		1.50 / 0.55	3840 / 1920	17/ 4	14.1 / 7.0	0.55 / 0.15	50 / 35	63
HCT/IMP-C-REV-35-2/4T	3450 / 1716		2.10 / 0.80	5940 / 2970	31/ 8	16.7 / 8.3	0.85 / 0.20	51 / 36	70
HCT/IMP-C-REV-38-2/4T-2	3528 / 1752		4.40 / 1.40	8200 / 4100	54/ 14	20.1 / 10.0	1.50 / 0.37	49 / 34	91
HCT/IMP-C-REV-40-2/4T-2	3528 / 1752		4.40 / 1.40	9250 / 4625	60/ 15	20.4 / 10.2	1.50 / 0.37	52 / 37	100
HCT/IMP-C-REV-45-2/4T-2	3528 / 1752		4.40 / 1.40	10300 / 5150	56/ 14	17.2 / 8.6	1.50 / 0.37	56 / 41	131
HCT/IMP-C-REV-45-2/4T-3	3516 / 1740		5.70 / 1.80	12800 / 6400	87/ 22	21.4 / 10.7	2.20 / 0.60	57 / 42	133
HCT/IMP-C-REV-50-2/4T-6	3516 / 1740		10.00 / 3.20	19000 / 9500	153/ 38	25.4 / 12.7	4.50 / 1.30	60 / 45	267

## Dimensions mm

### C: Circular casing

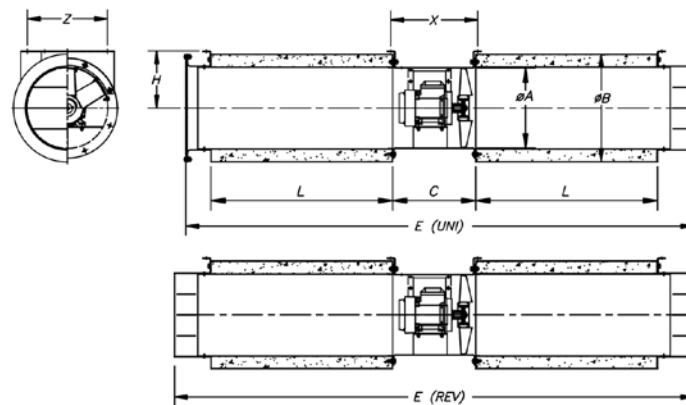

Model	ØA	ØB	C	L	Ød	E (UNI)	E (REV)	H	X	Z
HCT/IMP-C-31	315	415	320	700	10	1956	2000	220	345	275
HCT/IMP-C-35	355	460	325	700	12	1960	2005	250	346	300
HCT/IMP-C-38	380	415	340	1000	12	2570	2620	225	530	517
HCT/IMP-C-40	410	510	340	950	12	2485	2540	280	376	340
HCT/IMP-C-45	460	630	360	950	12	2500	2554	355	396	440

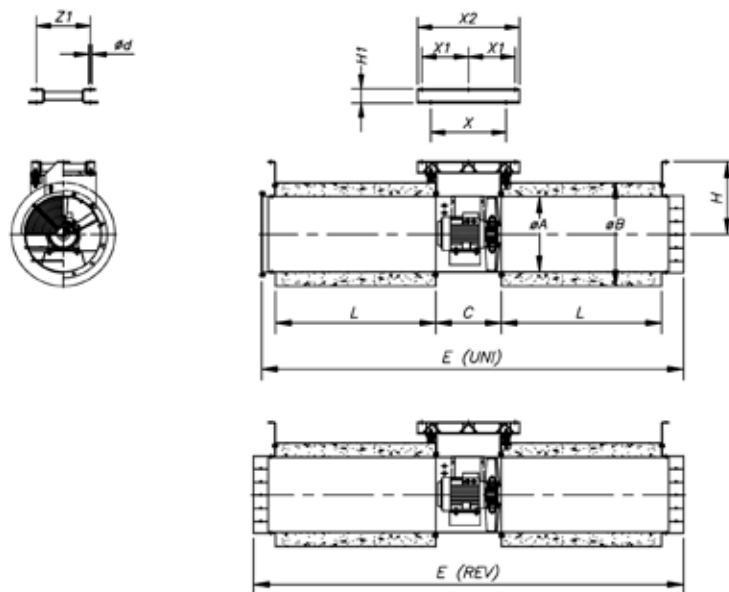

Model	ØA	ØB	C	L	Ød	E(UNI)	E(REV)	H	H1-	X	X1	X2	Z	Z1
HCT/IMP-C-50	514	710	450	1100	12	2895	2950	498	80	518	320	700	380	370

## Accessories



INT

C2V

AET

CENTRAL CO

VSD

P-400

# HCT/IMP

## Long-range one-way or reversible jet fans

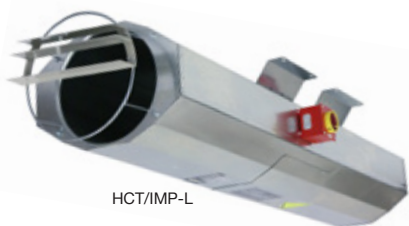

HCT/IMP-L

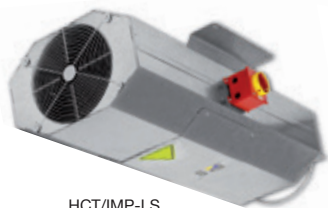

HCT/IMP-LS

Long range one-way or reversible jet fans with an octagonal design for air movement and CO extraction in car parks.

### Fan:

- One-way or reversible fan unit formed by a fan, silencers, deflectors and supports.
- Adjustable rotors designed to produce great thrusts.
- Anti-contact protective grille pursuant to standard UNE-EN ISO 12499.
- Deflector to increase the air range on the impulsion side. Reversible models are fitted with deflectors on both sides.
- High attenuation silencers with thermal and acoustic insulation.
- INT series safety switch built into the fan (HCT/IMP-L)
- Air direction from Motor to Rotor or 100 % reversible.
- HCT/IMP-L: Galvanised sheet steel casing.
- HCT/IMP-LS: Short length galvanised sheet steel casing.

### Motor:

- Class F motors with ball bearings, IP55 protection and with 1 or 2 speeds, depending on model.
- Three-phase 380-440V. 60Hz.
- Maximum temperature of air to be carried: -20 °C +40 °C.

### On request:

- Thrust features different from those indicated.
- Version approved for smoke evacuation in accordance with standard EN 12101-3 (see THT/IMP series).

### Finish:

- Anticorrosive finish galvanised sheet steel.

## Order code

<b>HCT/IMP</b>	—	<b>L</b>	—	<b>UNI</b>	—	<b>38</b>	—	<b>2/4T</b>	—	<b>1,5</b>	—	<b>60Hz</b>
HCT/IMP: Large range jet fans		Design L: Galvanised sheet steel casing. LS: Small-sized casing		Airflow direction UNI: One-way REV: Reversible		Rotor diameter in cm		Number of motor poles 2=3500 r/min. 60 Hz 4=1680 r/min. 60 Hz		T=Three-phase		Motor power (hp)

60Hz

## Technical characteristics

Model	Speed (r/min)	Maximum current (A)	Flow rate (m <sup>3</sup> /h)	Thrust (N)	Speed impulsion (m/s)	Installed power (kW)	Sound pressure LpA at 10m dB(A)	Approx. weight (kg)
<b>One-way</b>								
HCT/IMP-L-UNI-29-2/4T	3432 / 1716	2,60 / 0,95	-	4000 / 2000	21 / 5	16,8 / 8,4	0,55 / 0,15	37 / 22
HCT/IMP-L-UNI-35-2/4T	3450 / 1716	3,64 / 1,39	-	6360 / 3180	36 / 9	17,8 / 8,9	0,85 / 0,20	52 / 37
HCT/IMP-L-UNI-38-2/4T-1.5	3480 / 1740	5,02 / 1,91	-	8450 / 4225	57 / 15	20,7 / 10,3	1,10 / 0,25	47 / 32
HCT/IMP-L-UNI-40-2/4T-1.5	3480 / 1740	5,02 / 1,91	-	9250 / 4625	60 / 15	20,4 / 10,2	1,10 / 0,25	53 / 38
HCT/IMP-L-UNI-45-2/4T-2	3528 / 1752	7,62 / 2,42	-	10800 / 5400	62 / 15	18,1 / 9,0	1,50 / 0,37	57 / 42
HCT/IMP-L-UNI-45-2/4T-3	3516 / 1740	9,87 / 3,12	-	13200 / 6600	92 / 23	22,1 / 11,0	2,20 / 0,60	58 / 43
HCT/IMP-L-UNI-50-2/4T-6	3516 / 1740	17,32 / 5,54	-	19700 / 9850	165 / 41	26,4 / 13,2	4,50 / 1,30	60 / 45
HCT/IMP-LS-UNI-29-2/4T	3432 / 1716	2,60 / 0,95	-	4000 / 2000	21 / 5	16,8 / 8,4	0,55 / 0,15	39 / 24
HCT/IMP-LS-UNI-35-2/4T	3450 / 1716	3,64 / 1,39	-	6360 / 3180	36 / 9	17,8 / 8,9	0,85 / 0,20	54 / 39
HCT/IMP-LS-UNI-38-2/4T-1.5	3480 / 1740	5,02 / 1,91	-	8450 / 4225	57 / 15	20,7 / 10,3	1,10 / 0,25	49 / 34
HCT/IMP-LS-UNI-40-2/4T-1.5	3480 / 1740	5,02 / 1,91	-	9250 / 4625	60 / 15	20,4 / 10,2	1,10 / 0,25	55 / 40
HCT/IMP-LS-UNI-45-2/4T-2	3528 / 1752	7,62 / 2,42	-	10800 / 5400	62 / 15	18,1 / 9,0	1,50 / 0,37	59 / 44
HCT/IMP-LS-UNI-45-2/4T-3	3516 / 1740	9,87 / 3,12	-	13200 / 6600	92 / 23	22,1 / 11,0	2,20 / 0,60	60 / 45
HCT/IMP-LS-UNI-50-2/4T-6	3516 / 1740	17,32 / 5,54	-	19700 / 9850	165 / 41	26,4 / 13,2	4,50 / 1,30	62 / 47
HCT/IMP-L-UNI-29-2T-0.75	3312	2,57	1,49	4000	21	16,8	0,55	37
HCT/IMP-L-UNI-35-2T-1.5 IE3	3396	4,03	2,32	6360	36	17,8	1,1	52
HCT/IMP-L-UNI-38-2T-1.5 IE3	3396	4,03	2,32	8450	57	20,7	1,1	47
HCT/IMP-L-UNI-40-2T-1.5 IE3	3396	4,03	2,32	9250	60	20,4	1,1	53
HCT/IMP-L-UNI-45-2T-2 IE3	3450	5,34	3,07	10800	62	18,1	1,5	57
HCT/IMP-L-UNI-45-2T-3 IE3	3492	7,32	4,21	13200	92	22,1	2,2	58
HCT/IMP-L-UNI-50-2T-5.5 IE3	3480	13	7,5	19700	165	26,4	4	60

Technical characteristics

Model	Speed (r/min)	Maximum current (A)		Flow rate (m <sup>3</sup> /h)	Thrust (N)	Speed impulsion (m/s)	Installed power (kW)	Sound pressure LpA at 10m dB(A)	Approx. weight (kg)
		220-277 V	380-440V						
<b>One-way</b>									
HCT/IMP-LS-UNI-29-2T-0.75	3312	2,57	1,49	4000	21	16,8	0,55	39	59
HCT/IMP-LS-UNI-35-2T-1.5 IE3	3396	4,03	2,32	6360	36	17,8	1,1	54	62
HCT/IMP-LS-UNI-38-2T-1.5 IE3	3396	4,03	2,32	8450	57	20,7	1,1	49	80
HCT/IMP-LS-UNI-40-2T-1.5 IE3	3396	4,03	2,32	9250	60	20,4	1,1	55	87
HCT/IMP-LS-UNI-45-2T-2 IE3	3450	5,34	3,07	10800	62	18,1	1,5	59	117
HCT/IMP-LS-UNI-45-2T-3 IE3	3492	7,32	4,21	13200	92	22,1	2,2	60	128
HCT/IMP-LS-UNI-50-2T-5.5 IE3	3480	13	7,5	19700	165	26,4	4	62	195
HCT/IMP-L-UNI-29-4T-0.12	1584	0,65	0,38	1550	3	6,5	0,09	26	63
HCT/IMP-L-UNI-35-4T-0.12	1584	0,65	0,38	3210	10	9,3	0,09	33	59
HCT/IMP-L-UNI-38-4T-0.25	1620	1,23	0,71	4440	16	10,9	0,18	36	86
HCT/IMP-L-UNI-40-4T-0.33	1620	1,66	0,96	5170	20	11,4	0,25	38	96
HCT/IMP-L-UNI-45-4T-0.33	1620	1,66	0,96	5960	21	10,4	0,25	42	129
HCT/IMP-L-UNI-45-4T-0.5	1644	2,02	1,17	7100	29	12,4	0,37	43	118
HCT/IMP-L-UNI-50-4T-0.75	1656	2,92	1,69	10380	51	14,7	0,55	47	203
HCT/IMP-LS-UNI-29-4T-0.12	1584	0,65	0,38	1550	3	6,5	0,09	28	49
HCT/IMP-LS-UNI-35-4T-0.12	1584	0,65	0,38	3210	10	9,3	0,09	35	45
HCT/IMP-LS-UNI-38-4T-0.25	1620	1,23	0,71	4440	16	10,9	0,18	38	68
HCT/IMP-LS-UNI-40-4T-0.33	1620	1,66	0,96	5170	20	11,4	0,25	40	75
HCT/IMP-LS-UNI-45-4T-0.33	1620	1,66	0,96	5960	21	10,4	0,25	44	101
HCT/IMP-LS-UNI-45-4T-0.5	1644	2,02	1,17	7100	29	12,4	0,37	45	90
HCT/IMP-LS-UNI-50-4T-0.75	1656	2,92	1,69	10380	51	14,7	0,55	49	156

Model	Speed (r/min)	Maximum current (A)		Flow rate (m <sup>3</sup> /h)	Thrust (N)	Speed impulsion (m/s)	Installed power (kW)	Sound pressure LpA at 10m dB(A)	Approx. weight (kg)
		220-277 V	380-440V						
<b>Reversible</b>									
HCT/IMP-L-REV-29-2/4T	3432 / 1716	2,60 / 0,95	-	3400 / 1700	15 / 4	14,3 / 7,1	0,55 / 0,15	38 / 23	67
HCT/IMP-L-REV-35-2/4T	3450 / 1716	3,64 / 1,39	-	5940 / 2970	31 / 8	16,7 / 8,3	0,85 / 0,20	51 / 36	70
HCT/IMP-L-REV-38-2/4T-2	3528 / 1752	7,62 / 2,42	-	8200 / 4100	54 / 14	20,1 / 10,0	1,50 / 0,37	49 / 34	97
HCT/IMP-L-REV-40-2/4T-2	3528 / 1752	7,62 / 2,42	-	9250 / 4625	60 / 15	20,4 / 10,2	1,50 / 0,37	52 / 37	106
HCT/IMP-L-REV-45-2/4T-2	3528 / 1752	7,62 / 2,42	-	10300 / 5150	56 / 14	17,2 / 8,6	1,50 / 0,37	56 / 41	139
HCT/IMP-L-REV-45-2/4T-3	3516 / 1740	9,87 / 3,12	-	12800 / 6400	87 / 22	21,4 / 10,7	2,20 / 0,60	57 / 42	141
HCT/IMP-L-REV-50-2/4T-6	3516 / 1740	17,32 / 5,54	-	19000 / 9500	153 / 38	25,4 / 12,7	4,50 / 1,30	60 / 45	284
HCT/IMP-LS-REV-29-2/4T	3432 / 1716	2,60 / 0,95	-	3400 / 1700	15 / 4	14,3 / 7,1	0,55 / 0,15	40 / 25	55
HCT/IMP-LS-REV-35-2/4T	3450 / 1716	3,64 / 1,39	-	5940 / 2970	31 / 8	16,7 / 8,3	0,85 / 0,20	53 / 38	56
HCT/IMP-LS-REV-38-2/4T-2	3528 / 1752	7,62 / 2,42	-	8200 / 4100	54 / 14	20,1 / 10,0	1,50 / 0,37	51 / 36	77
HCT/IMP-LS-REV-40-2/4T-2	3528 / 1752	7,62 / 2,42	-	9250 / 4625	60 / 15	20,4 / 10,2	1,50 / 0,37	53 / 39	85
HCT/IMP-LS-REV-45-2/4T-2	3528 / 1752	7,62 / 2,42	-	10300 / 5150	56 / 14	17,2 / 8,6	1,50 / 0,37	58 / 43	111
HCT/IMP-LS-REV-45-2/4T-3	3516 / 1740	9,87 / 3,12	-	12800 / 6400	87 / 22	21,4 / 10,7	2,20 / 0,60	59 / 44	113
HCT/IMP-LS-REV-50-2/4T-6	3516 / 1740	17,32 / 5,54	-	19000 / 9500	153 / 38	25,4 / 12,7	4,50 / 1,30	62 / 47	227
HCT/IMP-L-REV-29-2T-0.75	3312	2,57	1,49	3400	15	14,3	0,55	38	71
HCT/IMP-L-REV-35-2T-1.5 IE3	3396	4,03	2,32	5940	31	16,7	1,1	51	76
HCT/IMP-L-REV-38-2T-2 IE3	3450	5,34	3,07	8200	54	20,1	1,5	49	102
HCT/IMP-L-REV-40-2T-2 IE3	3450	5,34	3,07	9250	60	20,4	1,5	52	111
HCT/IMP-L-REV-45-2T-2 IE3	3450	5,34	3,07	10300	56	17,2	1,5	56	144
HCT/IMP-L-REV-45-2T-3 IE3	3492	7,32	4,21	12800	87	21,4	2,2	57	156
HCT/IMP-L-REV-50-2T-5.5 IE3	3480	13	7,5	19000	153	25,4	4	60	292
HCT/IMP-LS-REV-29-2T-0.75	3312	2,57	1,49	3400	15	14,3	0,55	40	59
HCT/IMP-LS-REV-35-2T-1.5 IE3	3396	4,03	2,32	5940	31	16,7	1,1	53	62
HCT/IMP-LS-REV-38-2T-2 IE3	3450	5,34	3,07	8200	54	20,1	1,5	51	82
HCT/IMP-LS-REV-40-2T-2 IE3	3450	5,34	3,07	9250	60	20,4	1,5	53	90
HCT/IMP-LS-REV-45-2T-2 IE3	3450	5,34	3,07	10300	56	17,2	1,5	58	116
HCT/IMP-LS-REV-45-2T-3 IE3	3492	7,32	4,21	12800	87	21,4	2,2	59	128
HCT/IMP-LS-REV-50-2T-5.5 IE3	3480	13	7,5	19000	153	25,4	4	62	235
HCT/IMP-L-REV-29-4T-0.12	1584	0,65	0,38	1475	3	6,2	0,09	27	61
HCT/IMP-L-REV-35-4T-0.12	1584	0,65	0,38	3050	9	8,8	0,09	34	59
HCT/IMP-L-REV-38-4T-0.33	1620	1,66	0,96	4220	15	10,3	0,25	37	86
HCT/IMP-L-REV-40-4T-0.33	1620	1,66	0,96	4910	18	10,9	0,25	39	95
HCT/IMP-L-REV-45-4T-0.33	1620	1,66	0,96	5660	19	9,9	0,25	43	128
HCT/IMP-L-REV-45-4T-0.5	1644	2,02	1,17	6745	26	11,8	0,37	44	118
HCT/IMP-L-REV-50-4T-0.75	1656	2,92	1,69	9860	46	13,9	0,55	48	253
HCT/IMP-LS-REV-29-4T-0.12	1584	0,65	0,38	1475	3	6,2	0,09	29	49
HCT/IMP-LS-REV-35-4T-0.12	1584	0,65	0,38	3050	9	8,8	0,09	36	45
HCT/IMP-LS-REV-38-4T-0.33	1620	1,66	0,96	4220	15	10,3	0,25	39	66
HCT/IMP-LS-REV-40-4T-0.33	1620	1,66	0,96	4910	18	10,9	0,25	41	74
HCT/IMP-LS-REV-45-4T-0.33	1620	1,66	0,96	5660	19	9,9	0,25	45	100
HCT/IMP-LS-REV-45-4T-0.5	1644	2,02	1,17	6745	26	11,8	0,37	46	90
HCT/IMP-LS-REV-50-4T-0.75	1656	2,92	1,69	9860	46	13,9	0,55	50	196

### Dimensions mm

L: Galvanised sheet steel casing.  
LS: Small-sized casing

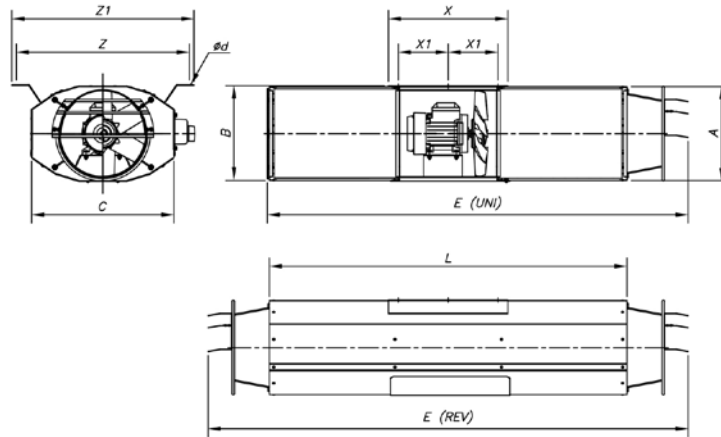

Model	A	B	C	ød	E (UNI)	E (REV)	L	X	X1	Z	Z1
HCT/IMP-LS-29	319,5	324	479	12x26	1410	1610	1200	400	167	580	610
HCT/IMP-L-29	319,5	324	479	12x26	2210	2410	2000	400	167	580	610
HCT/IMP-LS-35	383	386	523	12x26	1410	1610	1200	400	167	614	644
HCT/IMP-L-35	383	386	523	12x26	2210	2410	2000	400	167	614	644
HCT/IMP-LS-38	406	409	550	12x26	1410	1610	1200	400	170	640	670
HCT/IMP-L-38	406	409	550	12x26	2210	2410	2000	400	170	640	670
HCT/IMP-LS-40	436	439	582	12x26	1410	1610	1200	400	170	670	700
HCT/IMP-L-40	436	439	582	12x26	2210	2410	2000	400	170	670	700
HCT/IMP-LS-45	486	489	630	12x26	1410	1610	1200	400	170	724	754
HCT/IMP-L-45	486	489	630	12x26	2210	2410	2000	400	170	724	754
HCT/IMP-LS-50	546	549	742	12x26	1445	1675	1200	580	255	778	808
HCT/IMP-L-50	546	549	742	12x26	2245	2475	2000	580	255	778	808

### For use in garages

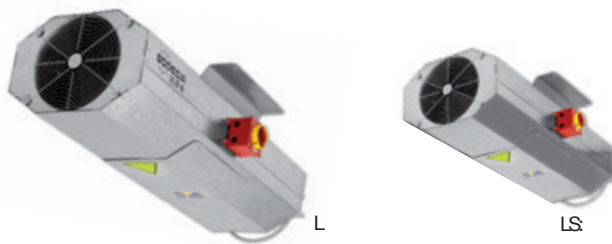

### Accessories





# HFW

## Hot dip galvanised tubular fans

Tubular axial fans designed with four support arms to reduce vibrations and fitted with an aerodynamic aluminium low-consumption rotor.



### Fan:

- Airflow direction from Motor to Impeller.
- AL version rotors made of cast aluminium.
- Support ring made of sheet steel with double flange and cable gland for motor power supply.
- Hot dip galvanised sheet steel tubular casing.

### Motor:

- IE3 efficiency motors for powers equal to or greater than 0.75kW except single-phase, 2-speed and 8-pole.
- Class F motors with ball bearings and IP55 protection.
- Multi voltage motor, special design valid for 220/380V 60Hz, 254/440V 60Hz, 265/460V 60Hz, 277/480V 60Hz.
- Operating temperature: -25°C +50 °C.

### Finish:

- Hot dip galvanised.

### On request:

- Airflow direction from Impeller to Motor.
- Fibreglass-reinforced polyamide PL version rotors.
- Rotors 100% reversible.
- Special windings for different voltages.
- ATEX-certified Category 2

## Order code

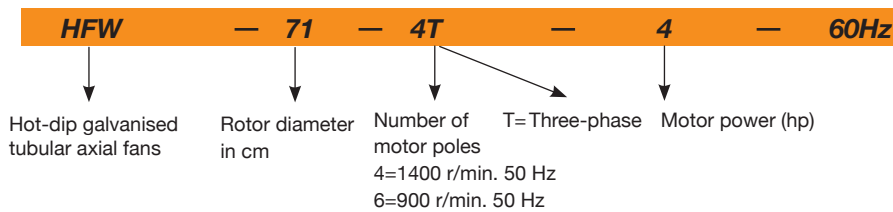

60Hz

## Technical characteristics

Model	Speed (r/min)	Max. admissible current (A)		Installed power (kW)	Blade inclination angle (°)	Max. flow rate (m³/h)	Sound pressure level dB(A)	Approx. weight (kg)
		220-277V	380-480V					
HFW-56-4T-1	1692	3.10	1.79	0.75	22	11250	76.65	28
HFW-56-4T-1.5	1680	4.03	2.32	1.10	30	13600	77.70	32
HFW-56-4T-2	1716	5.96	3.44	1.50	36	15050	78.75	30
HFW-56-6T-0.75	1092	2.59	1.49	0.55	38	10150	65.10	23
HFW-63-4T-1	1692	3.10	1.79	0.75	14	15200	76.65	29
HFW-63-4T-1.5	1680	4.03	2.32	1.10	20	17800	77.70	32
HFW-63-4T-2	1716	5.96	3.44	1.50	24	19300	78.75	35
HFW-63-4T-3	1734	8.36	4.83	2.20	32	22150	79.80	43
HFW-63-4T-4	1734	10.96	6.33	3.00	38	24250	80.85	45
HFW-63-6T-0.75	1092	2.59	1.49	0.55	28	13600	68.25	29
HFW-63-6T-1	1134	3.90	2.20	0.75	38	15900	69.30	35
HFW-71-4T-1.5	1680	4.03	2.32	1.10	12	19500	81.90	35
HFW-71-4T-2	1716	5.96	3.44	1.50	14	20900	82.95	38
HFW-71-4T-3	1734	8.36	4.83	2.20	22	25100	85.05	47
HFW-71-4T-4	1734	10.96	6.33	3.00	28	27500	86.10	49
HFW-71-6T-0.75	1092	2.59	1.49	0.55	20	16100	70.35	31
HFW-71-6T-1	1134	3.90	2.20	0.75	26	17300	71.40	38
HFW-71-6T-1.5	1134	4.88	2.82	1.10	34	19950	72.45	40
HFW-80-4T-3	1734	8.36	4.83	2.20	12	25450	86.10	55
HFW-80-4T-4	1734	10.96	6.33	3.00	16	30250	87.15	57
HFW-80-4T-5.5	1728	14.10	8.12	4.00	18	32750	88.20	62
HFW-80-6T-1.5	1134	4.88	2.82	1.10	18	21450	75.60	48
HFW-80-6T-2	1146	6.42	3.71	1.50	26	25950	76.65	54
HFW-80-6T-3	1146	9.30	5.30	2.20	32	29950	77.70	59
HFW-90-4T-4	1734	10.96	6.33	3.00	8	33600	91.35	66
HFW-90-4T-5.5	1728	14.10	8.12	4.00	12	38900	93.45	71
HFW-90-4T-7.5	1728		10.60	5.50	18	46150	95.55	87
HFW-90-4T-10 IE3	1758		8.06	7.50	22	50150	96.60	98
HFW-90-6T-2	1146	6.42	3.71	1.50	16	28800	80.85	63
HFW-90-6T-3	1146	9.30	5.30	2.20	24	34000	81.90	68
HFW-90-6T-4	1152	12.70	7.30	3.00	30	38900	82.95	92
HFW-100-4T-7.5	1728		10.60	5.50	10	46850	96.60	95
HFW-100-4T-10 IE3	1758		8.06	7.50	16	57400	97.65	106
HFW-100-4T-15 IE3	1764		20.90	11.00	22	66300	98.70	129
HFW-100-4T-20 IE3	1764		28.30	15.00	28	76150	99.75	148
HFW-100-6T-3	1146	9.30	5.30	2.20	16	37600	86.10	76
HFW-100-6T-4	1152	12.70	7.30	3.00	20	41150	87.15	100
HFW-100-6T-5.5	1152	16.50	9.46	4.00	26	47800	88.20	108

## Acoustic characteristics

The indicated values are determined by measuring the sound pressure level and sound power in dB(A) obtained in a free field at a distance equivalent to twice the size of the fan plus the rotor diameter, with a minimum of 1.5 m.

Sound power spectrum Lw(A) in dB(A) per Hz frequency band

Model	63	125	250	500	1000	2000	4000	8000	Model	63	125	250	500	1000	2000	4000	8000
HFW-56-4T-1	48	68	76	81	83	80	73	62	HFW-80-4T-4	56	76	84	89	91	88	81	74
HFW-56-4T-1.5	49	69	77	82	84	81	74	63	HFW-80-4T-5.5	56	76	84	89	91	88	81	70
HFW-56-4T-2	50	70	78	83	85	82	75	64	HFW-80-6T-1.5	49	66	74	79	81	78	71	60
HFW-56-6T-0.75	37	57	65	70	72	69	62	51	HFW-80-6T-2	50	67	75	80	82	79	72	61
HFW-63-4T-1	50	70	78	83	85	82	75	64	HFW-80-6T-3	51	68	76	81	83	80	73	62
HFW-63-4T-1.5	48	68	76	81	83	80	73	65	HFW-90-4T-4	61	82	89	94	97	93	86	79
HFW-63-4T-2	52	68	76	81	83	80	73	66	HFW-90-4T-5.5	60	81	88	93	96	92	85	74
HFW-63-4T-3	53	70	78	83	85	82	77	67	HFW-90-4T-7.5	59	80	87	92	95	91	84	73
HFW-63-4T-4	54	71	79	84	86	83	78	68	HFW-90-4T-10	58	79	86	91	94	90	83	72
HFW-63-6T-0.75	42	60	68	73	75	72	65	56	HFW-90-6T-2	58	79	86	91	94	90	83	72
HFW-63-6T-1	43	62	70	75	77	74	67	57	HFW-90-6T-3	56	70	77	82	85	81	74	63
HFW-71-4T-1.5	54	74	82	87	89	86	79	69	HFW-90-6T-4	57	72	79	84	87	83	76	65
HFW-71-4T-2	53	73	81	86	88	85	78	70	HFW-100-4T-7.5	64	84	92	97	99	96	89	78
HFW-71-4T-3	58	72	80	85	87	84	77	71	HFW-100-4T-10	62	82	90	95	97	94	87	76
HFW-71-4T-4	59	73	81	86	88	85	78	72	HFW-100-4T-15	61	81	89	94	96	93	86	75
HFW-71-6T-0.75	44	63	72	74	76	73	66	55	HFW-100-4T-20	63	83	91	96	98	95	88	77
HFW-71-6T-1	45	65	73	75	77	74	67	56	HFW-100-6T-3	61	72	80	85	87	84	77	66
HFW-71-6T-1.5	46	66	71	76	78	75	68	57	HFW-100-6T-4	64	72	80	85	87	84	77	66
HFW-80-4T-3	57	77	85	90	92	89	82	73	HFW-100-6T-5.5	64	73	81	86	88	85	78	67

## Dimensions mm

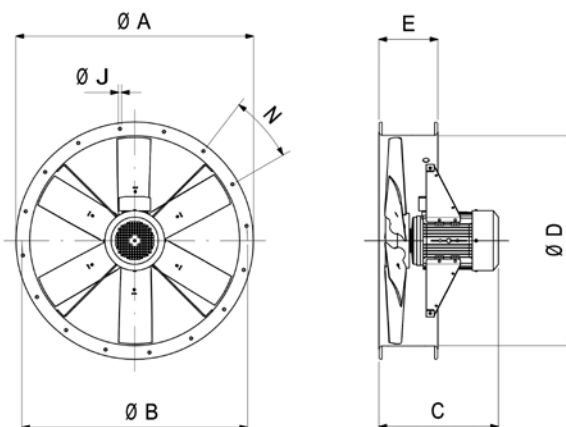

	ØA	ØB	0.75	1	1.5	2	3	C	4	5.5	7.5	10	15	20	ØD	E	ØJ	N
HFW-56-4	665	620	-	330	380	380	-	-	-	-	-	-	-	-	560	225	12	12x30°
HFW-56-6	665	620	330	-	-	-	-	-	-	-	-	-	-	-	560	225	12	12x30°
HFW-63-4	735	690	-	379	429	429	470	470	-	-	-	-	-	-	640	225	12	12x30°
HFW-63-6	735	690	379	429	-	-	-	-	-	-	-	-	-	-	640	225	12	12x30°
HFW-71-4	815	770	-	-	389	389	430	430	-	-	-	-	-	-	710	225	12	16x22°30'
HFW-71-6	815	770	339	389	389	-	-	-	-	-	-	-	-	-	710	225	12	16x22°30'
HFW-80-4	905	860	-	-	-	-	436	436	460	-	-	-	-	-	800	225	12	16x22°30'
HFW-80-6	905	860	-	-	395	436	460	-	-	-	-	-	-	-	800	225	12	16x22°30'
HFW-90-4	1018	970	-	-	-	-	-	401	425	485	525	-	-	-	900	225	15	16x22°30'
HFW-90-6	1018	970	-	-	-	401	425	485	-	-	-	-	-	-	900	225	15	16x22°30'
HFW-100-4	1118	1070	-	-	-	-	-	-	-	488	528	643	703	1000	225	15	16x22°30'	
HFW-100-6	1118	1070	-	-	-	-	428	488	528	-	-	-	-	-	1000	225	15	16x22°30'

## Accessories

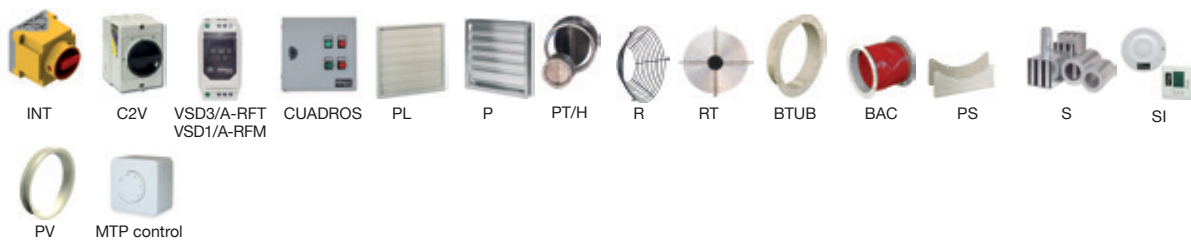

**Characteristic curves**

Q= Flow rate in m<sup>3</sup>/h, m<sup>3</sup>/s and cfm.

Pe= Static pressure in mm H<sub>2</sub>O, Pa and inwg.

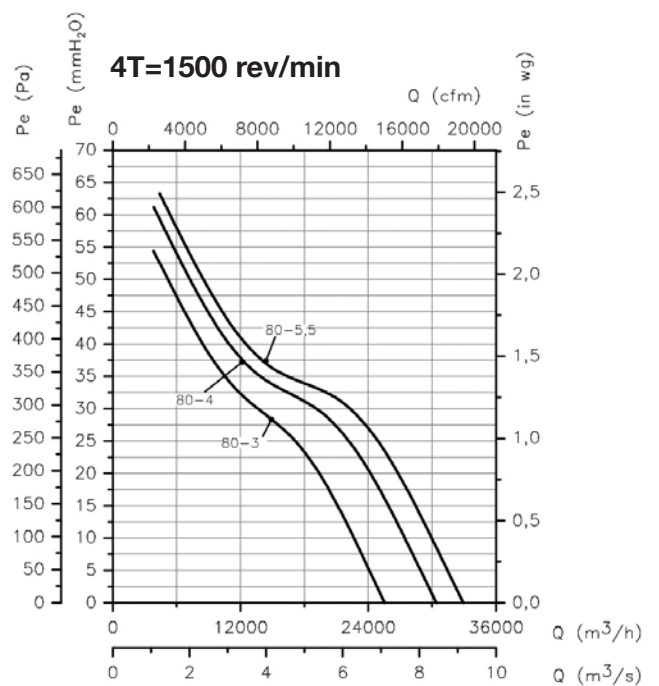
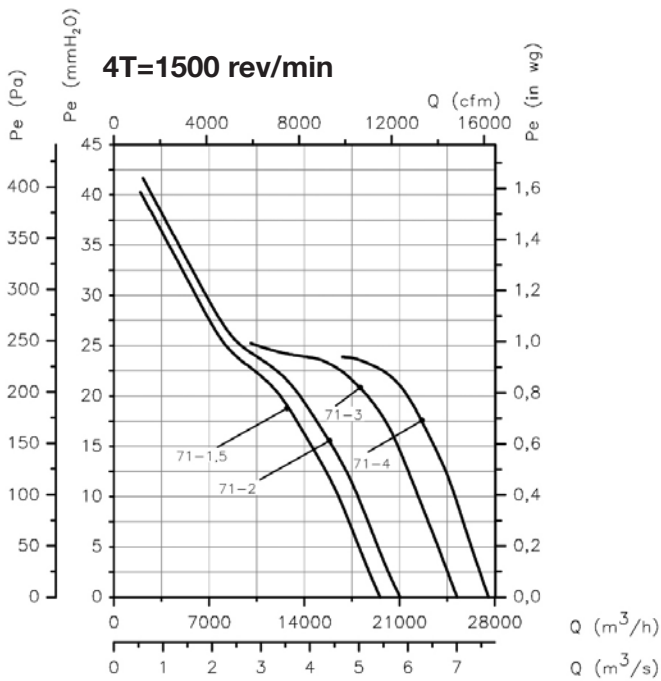
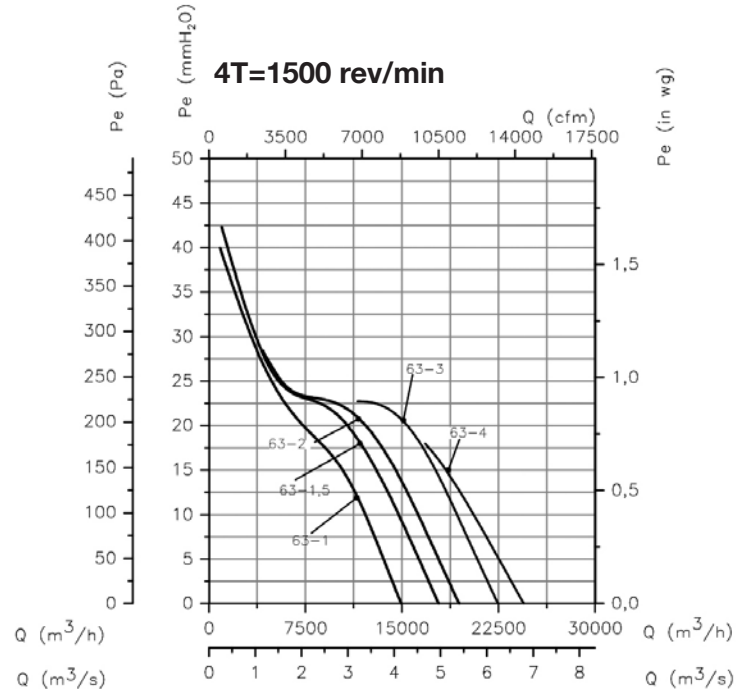
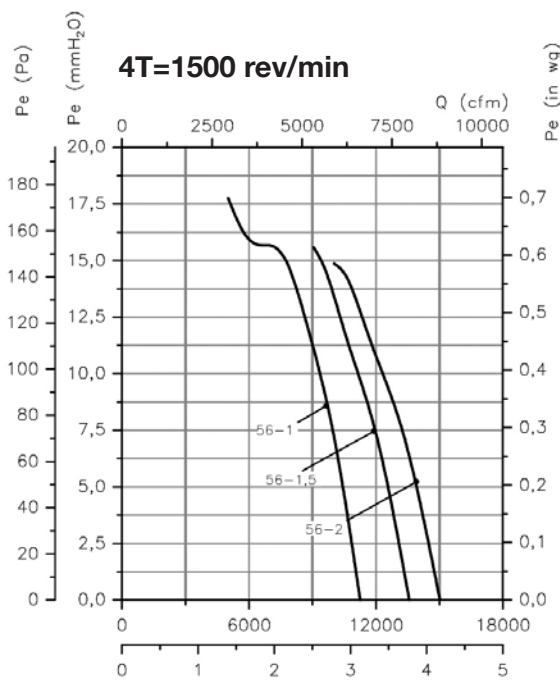

**Characteristic curves**

Q= Flow rate in m<sup>3</sup>/h, m<sup>3</sup>/s and cfm.

Pe= Static pressure in mm H<sub>2</sub>O, Pa and inwg.

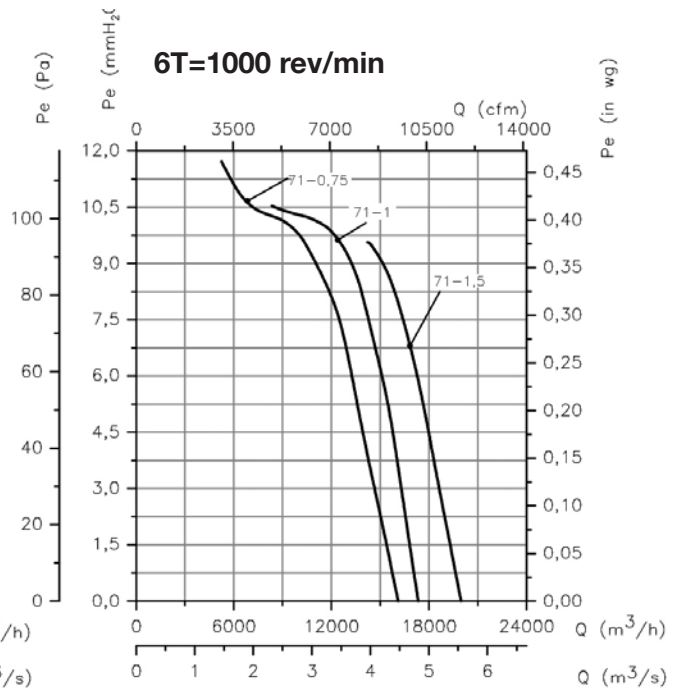
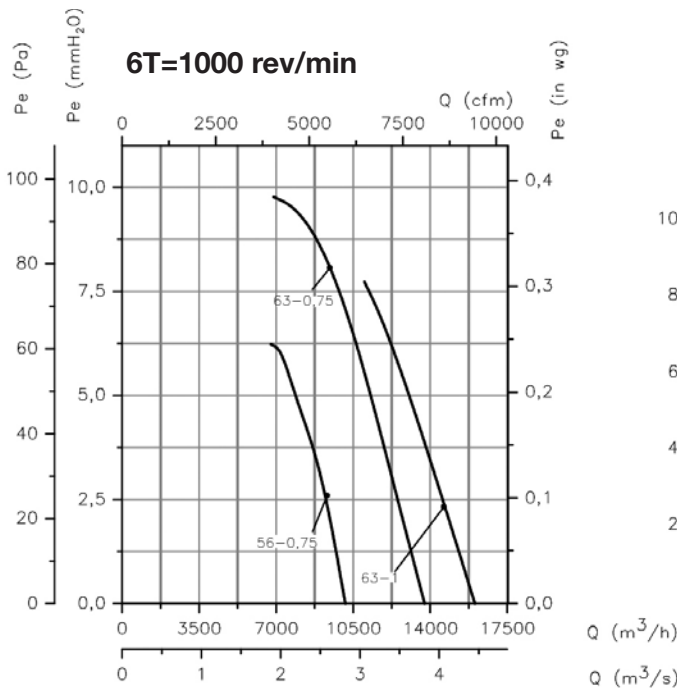
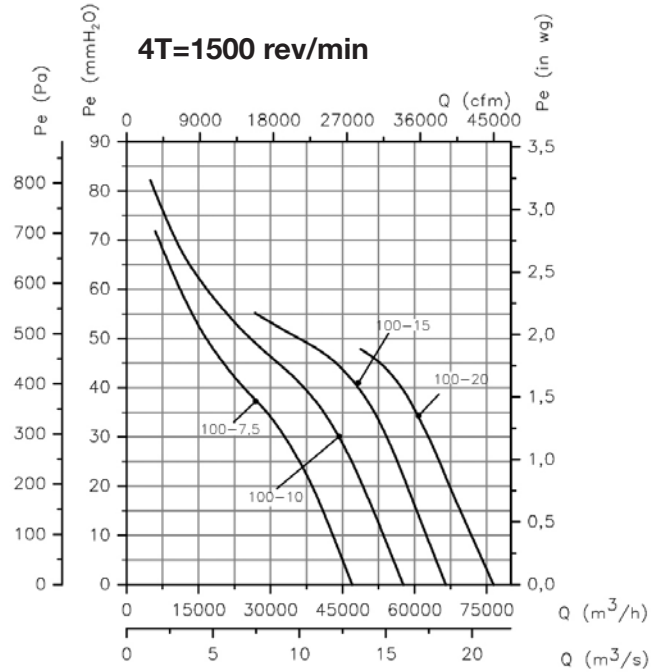
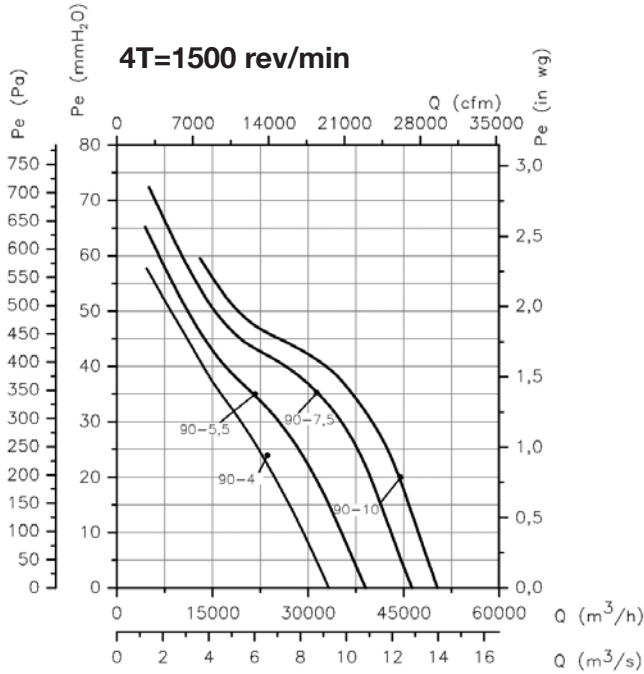

**Characteristic curves**

Q= Flow rate in m<sup>3</sup>/h, m<sup>3</sup>/s and cfm.

Pe= Static pressure in mm H<sub>2</sub>O, Pa and inwg.

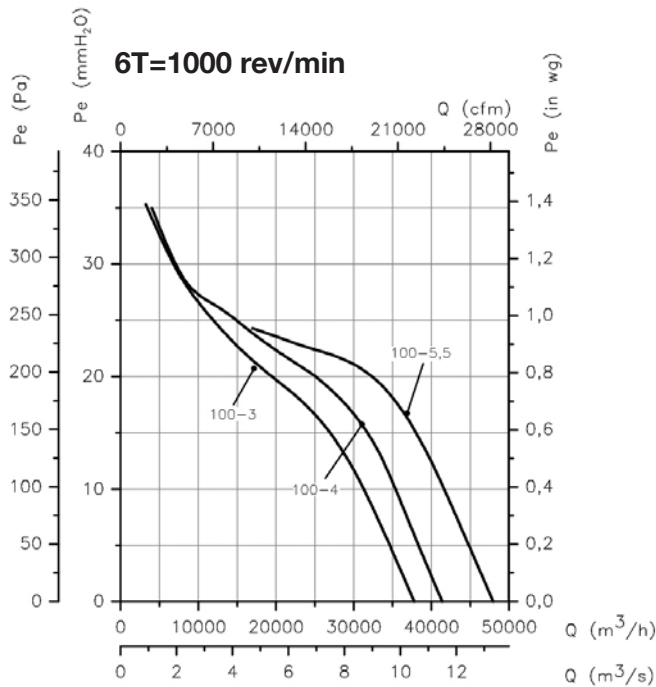
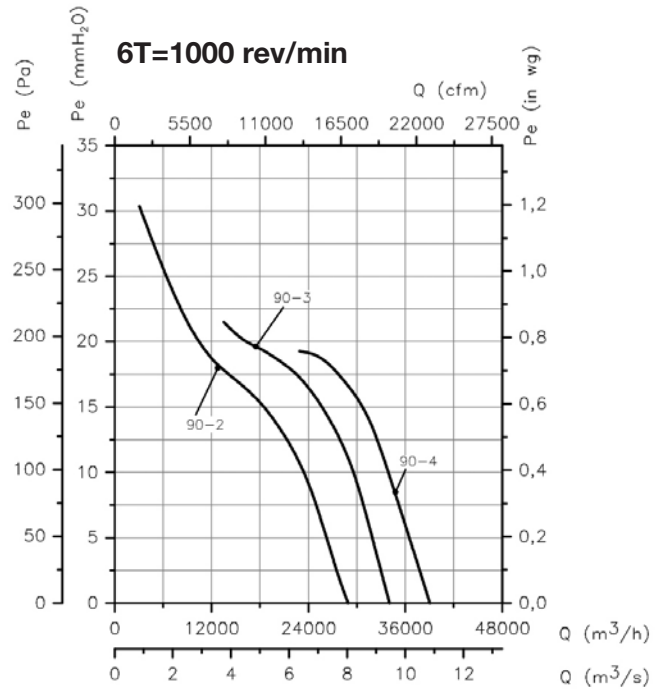
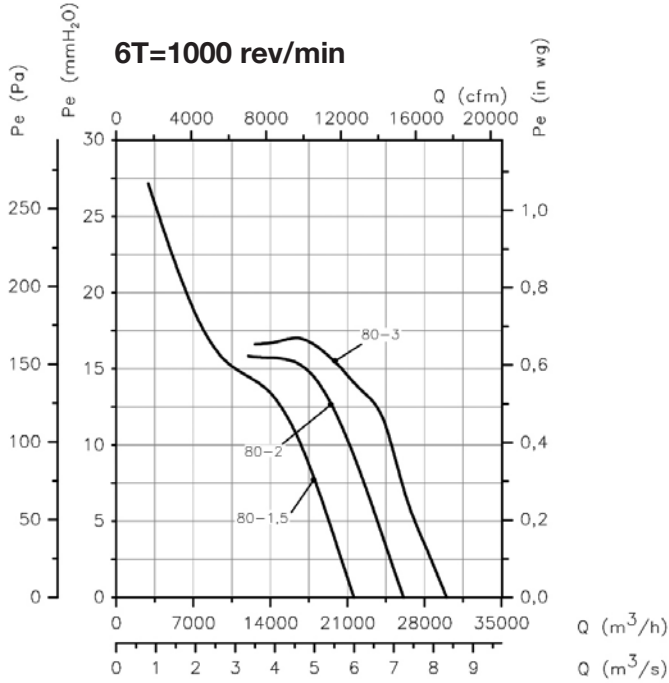



**Technical characteristics**

Model	Speed (r/min)	Maximum admissible current (A)		Installed power (kW)	Maximum flow rate (m³/h)	Approx. weight (kg)	NPS dB(A)
		220-277V	380-480V				
HTP-80-4T-5.5	1740	15.30	8.80	4.00	19750	152	86
HTP-80-4T-7.5	1740	-	11.20	5.50	23150	166	86
HTP-80-4T-10	1740	-	15.30	7.50	29600	177	87
HTP-80-4T-15	1740	-	20.90	11.00	35550	217	91
HTP-90-4T-7.5	1740	-	11.20	5.50	25400	196	90
HTP-90-4T-10	1740	-	15.30	7.50	29700	207	90
HTP-90-4T-15	1740	-	20.90	11.00	35900	247	90
HTP-90-4T-20	1740	-	28.50	15.00	45050	266	94
HTP-90-4T-25	1775	-	34.50	18.50	47850	294	95
HTP-90-4T-30	1775	-	40.90	22.00	53850	311	97
HTP-100-4T-15	1740	-	20.90	11.00	40950	282	93
HTP-100-4T-20	1740	-	28.50	15.00	50750	301	93
HTP-100-4T-25	1775	-	34.50	18.50	55300	329	93
HTP-100-4T-30	1775	-	40.90	22.00	59350	346	96
HTP-100-4T-40	1775	-	55.30	30.00	71900	401	98
HTP-125-4T-40	1775	-	55.30	30.00	69400	503	100
HTP-125-4T-50	1775	-	68.00	37.00	79650	525	100
HTP-125-4T-60	1775	-	81.30	45.00	89750	558	100
HTP-125-4T-75	1775	-	98.90	55.00	97200	599	100
HTP-125-4T-100	1775	-	135.00	75.00	126050	674	104
HTP-125-4T-125	1775	-	163.00	90.00	144450	703	105

**Acoustic characteristics**

The indicated values are determined by measuring the sound pressure and power levels in dB(A), obtained in a free field at a distance equivalent to twice the size of the fan plus the diameter of the rotor, with a minimum of 1.5 m.

Model Lp dB(A)	Sound power spectrum Lw(A) in dB(A) per Hz frequency band										Model Lp dB(A)										
	63	125	250	500	1000	2000	4000	8000	63	125		250	500	1000	2000	4000	8000				
HTP-50-2T-4	80	57	77	85	90	92	89	82	71	HTP-80-4T-4	86	58	75	86	95	96	96	93	86		
HTP-50-2T-5.5	81	58	78	86	91	93	90	83	72	HTP-80-4T-5.5	86	58	76	86	95	96	96	93	86		
HTP-56-2T-5.5	86	63	83	91	96	98	95	88	77	HTP-80-4T-7.5	86	58	76	86	95	96	96	93	86		
HTP-56-2T-10	87	64	84	92	97	99	96	89	78	HTP-80-4T-10	87	59	77	87	97	98	98	94	88		
HTP-63-2T-10	94	70	82	92	104	105	104	99	91	HTP-80-4T-15	91	63	81	91	101	102	102	99	92		
HTP-63-2T-15	94	70	82	92	104	105	104	99	91	HTP-90-4T-7.5	90	62	79	90	99	100	100	97	90		
HTP-63-2T-20	97	73	85	95	107	108	107	102	94	HTP-90-4T-10	90	62	80	90	99	100	100	97	90		
HTP-63-2T-25	98	74	86	96	108	109	108	103	95	HTP-90-4T-15	90	62	80	90	100	101	101	98	91		
HTP-63-2T-30	99	75	87	97	109	110	109	104	96	HTP-90-4T-20	94	66	83	94	103	104	104	101	94		
HTP-63-4T-1.5	79	55	67	77	89	90	89	84	76	HTP-90-4T-25	95	67	85	95	104	105	105	102	95		
HTP-63-4T-2	79	55	67	77	89	90	89	84	76	HTP-90-4T-30	97	69	87	97	107	108	108	104	98		
HTP-63-4T-3	83	59	71	81	93	94	93	88	80	HTP-100-4T-15	93	65	83	93	102	103	103	100	93		
HTP-63-4T-4	84	60	72	82	94	95	94	89	81	HTP-100-4T-20	93	65	82	93	102	103	103	100	93		
HTP-71-2T-15	93	65	83	93	102	104	103	100	93	HTP-100-4T-25	93	65	83	93	102	103	103	100	93		
HTP-71-2T-20	95	67	85	95	104	106	105	102	95	HTP-100-4T-30	96	67	85	96	105	106	106	103	96		
HTP-71-2T-25	95	67	85	95	104	106	105	102	95	HTP-100-4T-40	98	70	88	98	107	108	108	105	98		
HTP-71-2T-30	95	67	85	95	104	106	105	102	95	HTP-125-4T-20	100	72	89	100	109	110	110	107	100		
HTP-71-2T-40	98	70	88	98	107	109	108	105	98	HTP-125-4T-50	100	72	90	100	109	110	110	107	100		
HTP-71-4T-2	83	55	73	83	92	93	93	90	83	HTP-125-4T-60	100	72	89	100	109	110	110	107	100		
HTP-71-4T-3	83	55	72	83	92	93	93	90	83	HTP-125-4T-75	100	72	90	100	110	111	111	108	101		
HTP-71-4T-4	84	56	74	84	94	95	95	91	85	HTP-125-4T-100	104	76	93	104	113	114	114	111	104		
HTP-71-4T-5.5	87	59	77	87	97	98	98	95	88	HTP-125-4T-125	105	77	95	105	114	115	115	112	105		
HTP-71-4T-7.5	90	62	80	90	100	101	101	97	91												

**Dimensions mm**

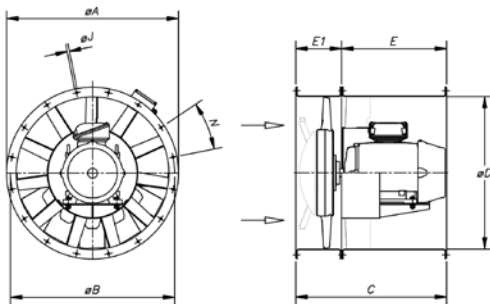

Model	Power	ØA	ØB	ØD	E	E1	C	ØJ	N
HTP-50-2T	4/5.5	600	560	514	-	-	400	12	12x30°
HTP-56-2T	5.5/10	660	620	560	-	-	500	12	12x30°
HTP-63-2T	10/15/20/25/30	730	690	640	650	220	870	13	12x30°
HTP-63-4T	1.5/2/3/4	730	690	640	340	220	560	13	12x30°
HTP-71-2T	15/20/25/30/40	810	770	710	700	240	940	13	16x22°30'
HTP-71-4T	2/3/4/5.5/7.5	810	770	710	420	240	660	13	16x22°30'
HTP-80-4T	4 / 5.5	900	860	800	360	240	600	15	16x22°30'
HTP-80-4T	7.5 / 10 / 15	900	860	800	600	240	840	15	16x22°30'
HTP-90-4T	7.5 / 10	1015	970	900	420	250	670	15	16x22°30'
HTP-90-4T	15 / 20 / 25 / 30	1015	970	900	650	250	900	15	16x22°30'
HTP-100-4T	15 / 20	1115	1070	1000	600	270	870	15	16x22°30'
HTP-100-4T	25 / 30 / 40	1115	1070	1000	700	270	970	15	16x22°30'
HTP-125	40 / 50 / 60 / 75	1365	1320	1250	900	300	1100	15	20x18°
HTP-125	100 / 125	1365	1320	1250	950	300	1250	15	20x18°

## SELECTION EXAMPLE

### Characteristic curves

Q= Flow rate in m<sup>3</sup>/h, m<sup>3</sup>/s and cfm.

Pe= Static pressure in mmH<sub>2</sub>O, Pa and inwg.

### HTP-63-4T

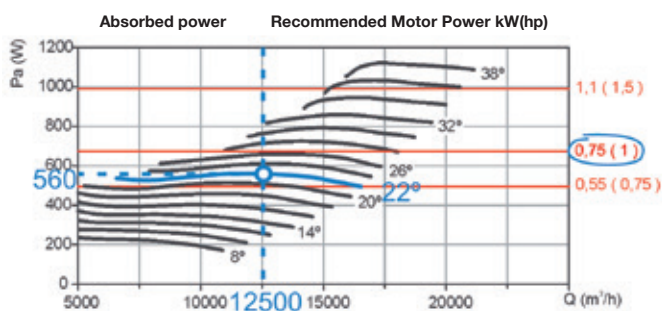
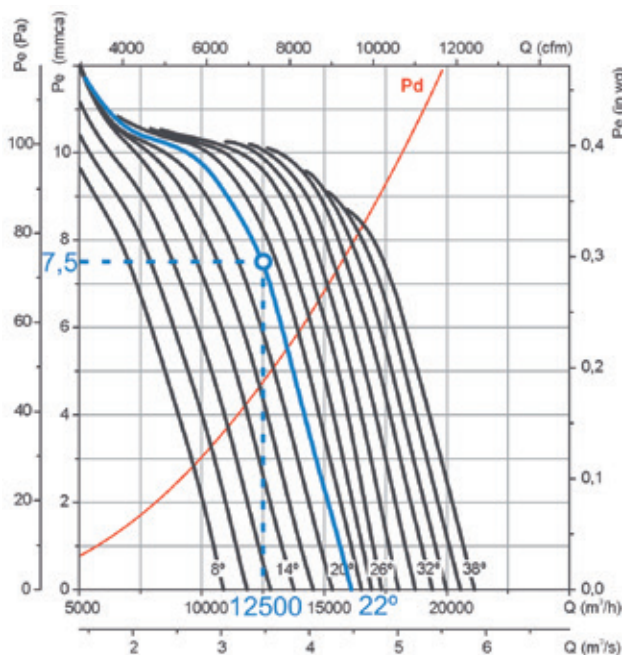

### Starting data

- Working point:
- Flow rate: 12,500 m<sup>3</sup>/h
- Load loss: 7.5 mm H<sub>2</sub>O

### Equipment selection steps

#### On the pressure graph:

1. Mark the working point defined by the flow rate (12,500 m<sup>3</sup>/h) and the load loss (7.5 mm H<sub>2</sub>O).
2. Select the nearest equipment curve above the working point. In this case, a blade angle curve of 22° is obtained.

#### On the power graph:

3. Mark the working point defined by the working flow rate (12,500 m<sup>3</sup>/h) and the selected blade angle curve (22°).
4. Read the absorbed power on the left power axis. Pa= 560 W at the working point.
5. Find the nearest straight red line above the working point. The installed motor power is given on the right side of the graph. In this case, 0.75 kW or 1 hp

## ORDER CODE EXAMPLE

**HTP** — **63** — **4T** — **1** — **22°**

↓  
Tubular, high pressure,  
axial extractor fans

↓  
Rotor diameter  
in cm

↓  
Number of motor poles  
4=1680 r/min. 60 Hz  
6=1080 r/min. 60 Hz  
8=900 r/min. 60 Hz

↓  
T= Three-phase  
M=Single-phase

↓  
Motor power  
(hp)

↓  
Blade inclina-  
tion angle



**Characteristic curves**

Q= Flow rate in m<sup>3</sup>/h, m<sup>3</sup>/s and cfm.

Pe= Static pressure in mm H<sub>2</sub>O, Pa and inwg.

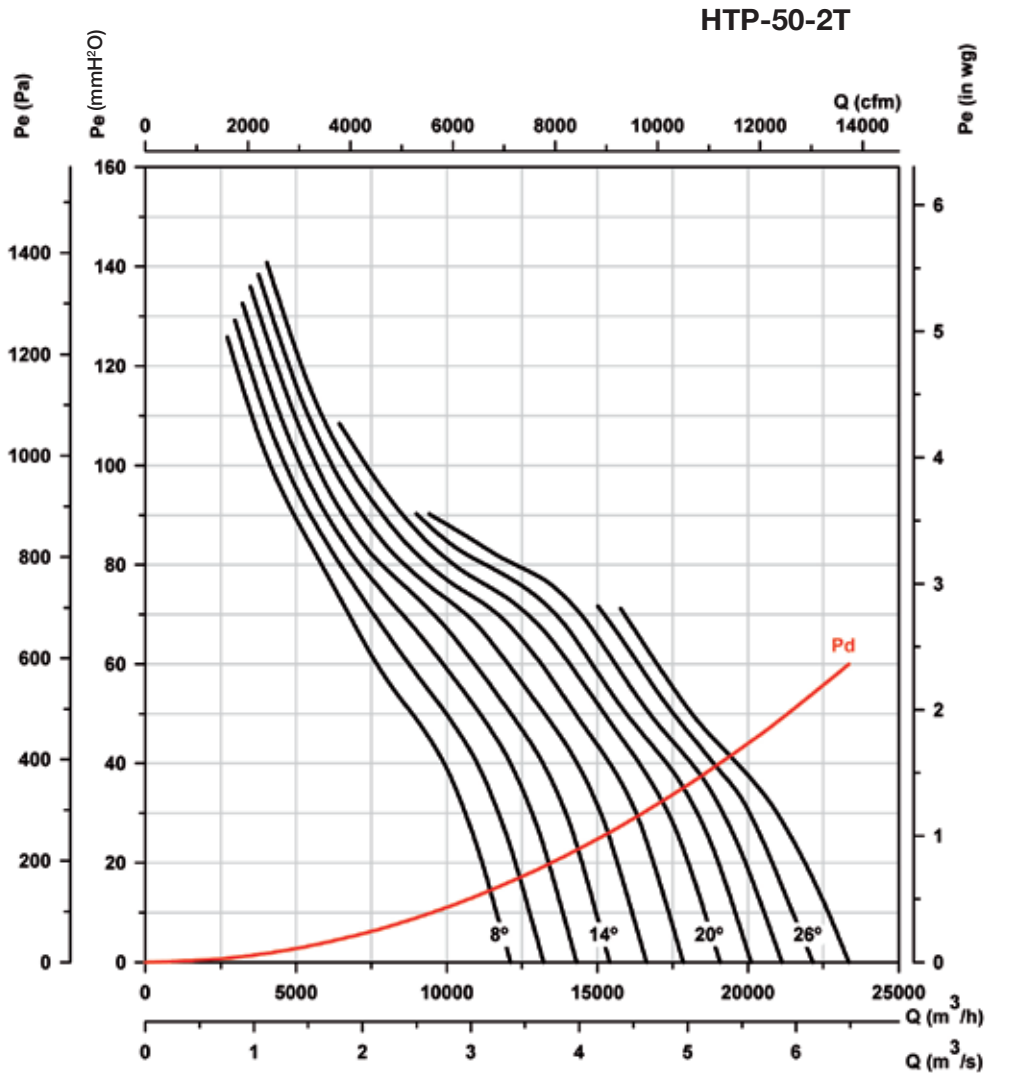

**Absorbed power**

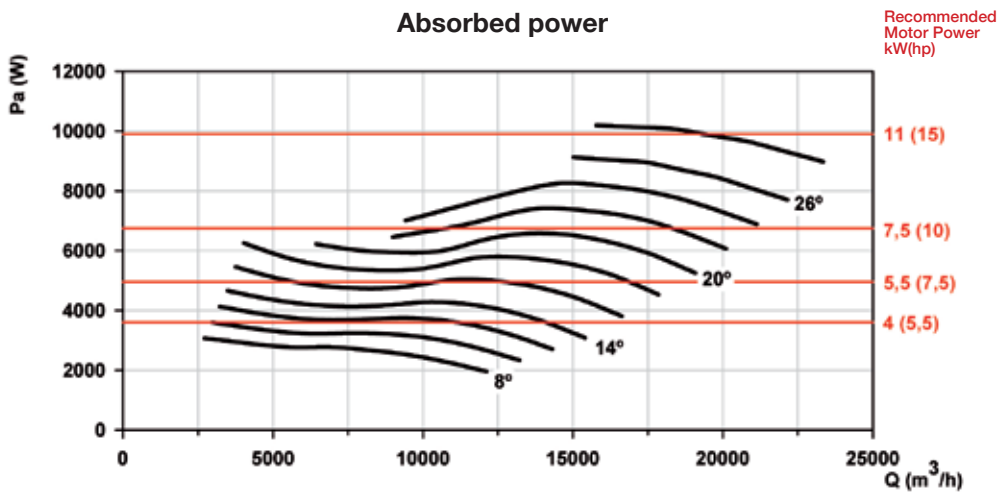

**Characteristic curves**

Q= Flow rate in m<sup>3</sup>/h, m<sup>3</sup>/s and cfm.

Pe= Static pressure in mm H<sup>2</sup>O, Pa and inwg.

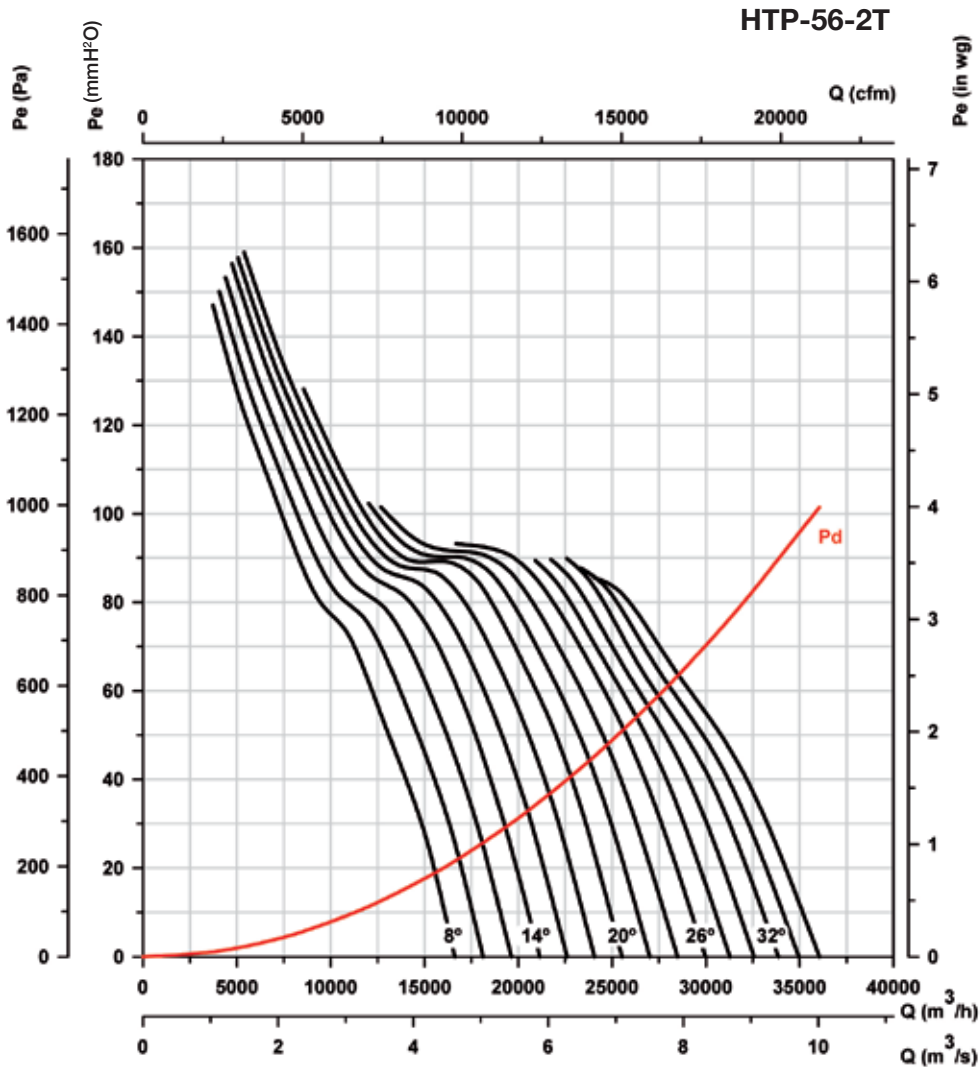

Absorbed power

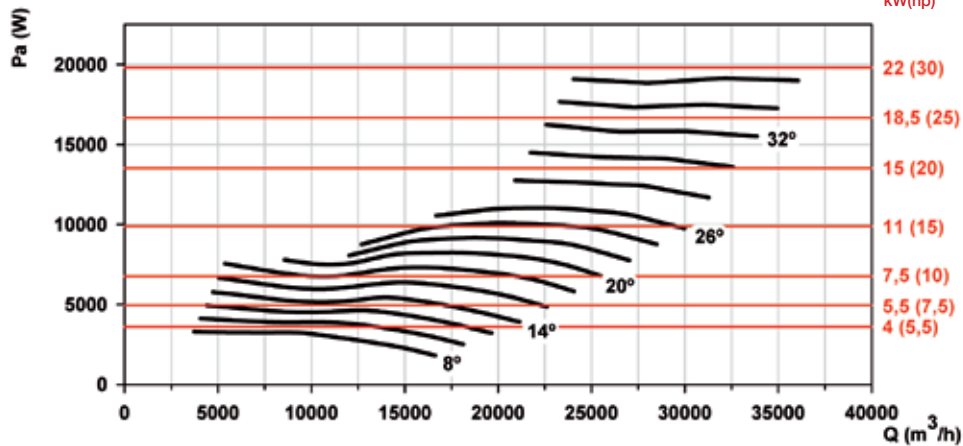

Recommended Motor Power kW(hp)

**Characteristic curves**

Q= Flow rate in m<sup>3</sup>/h, m<sup>3</sup>/s and cfm.

Pe= Static pressure in mm H<sub>2</sub>O, Pa and inwg.

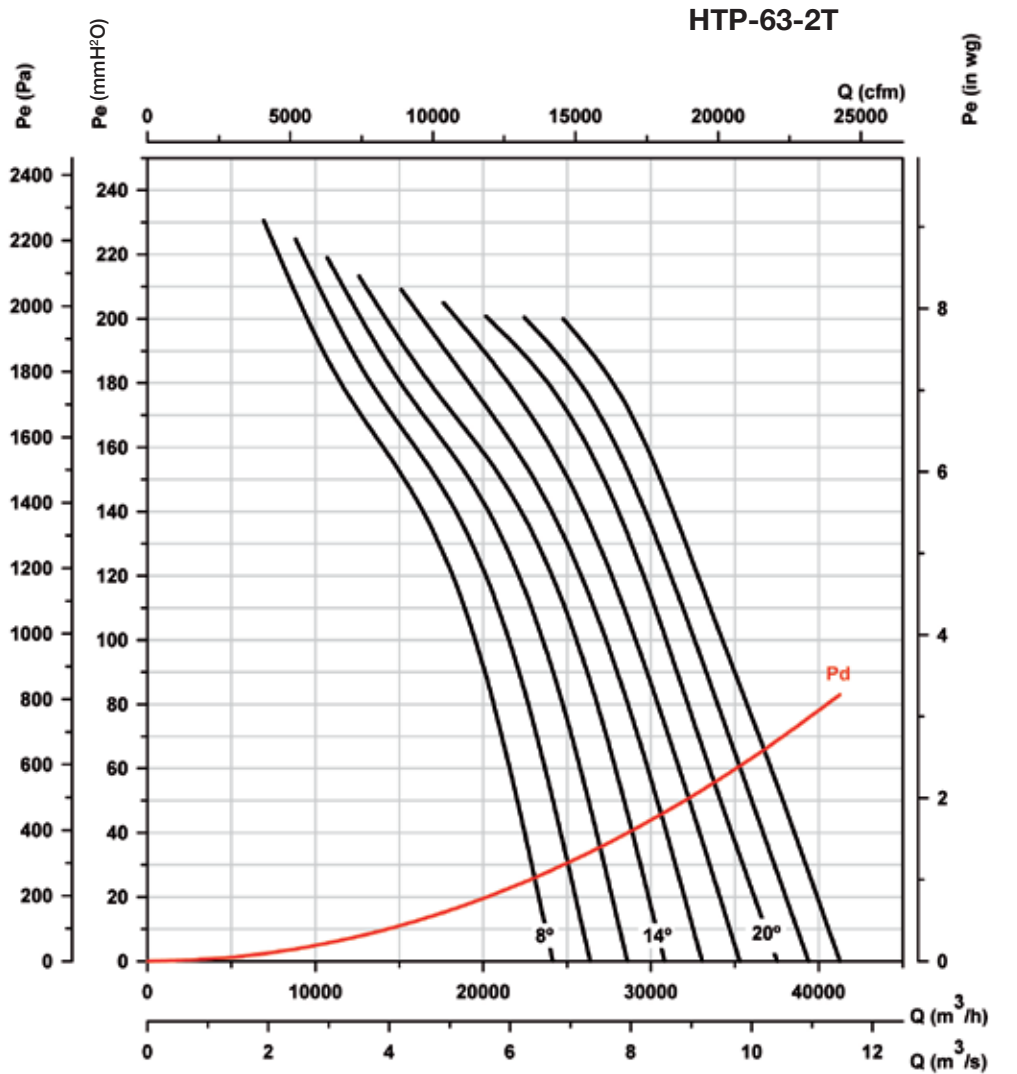

Absorbed power

Recommended Motor Power kW(hp)

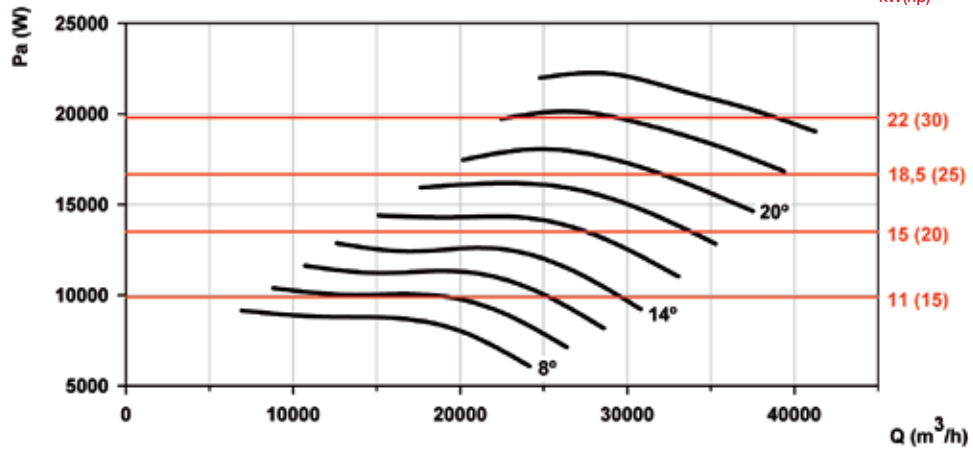

**Characteristic curves**

Q= Flow rate in m<sup>3</sup>/h, m<sup>3</sup>/s and cfm.

Pe= Static pressure in mm H<sub>2</sub>O, Pa and inwg.

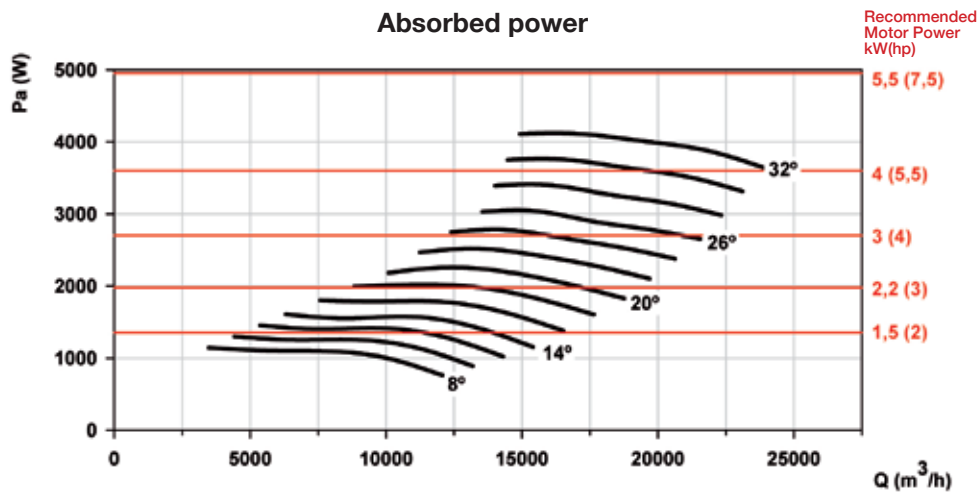
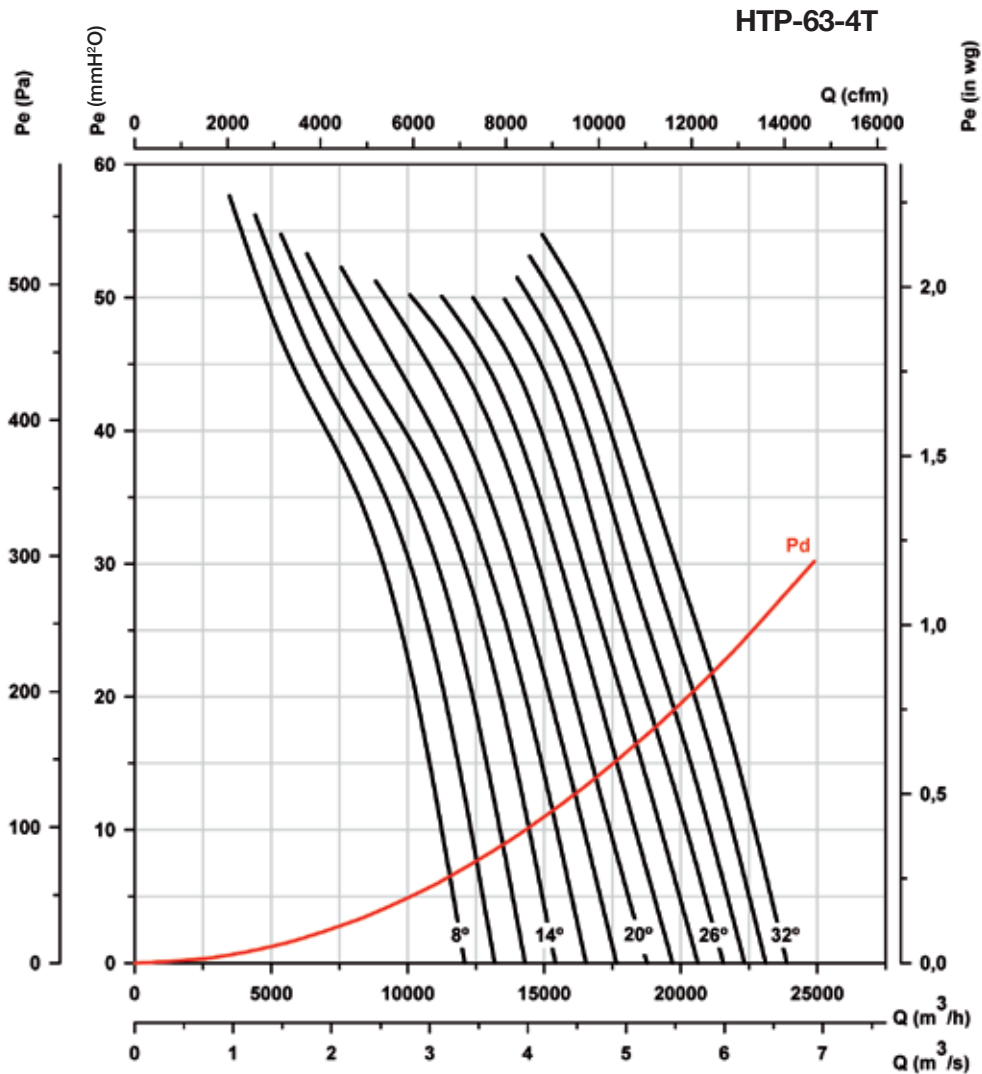

**Characteristic curves**

Q= Flow rate in m<sup>3</sup>/h, m<sup>3</sup>/s and cfm.

Pe= Static pressure in mm H<sub>2</sub>O, Pa and inwg.

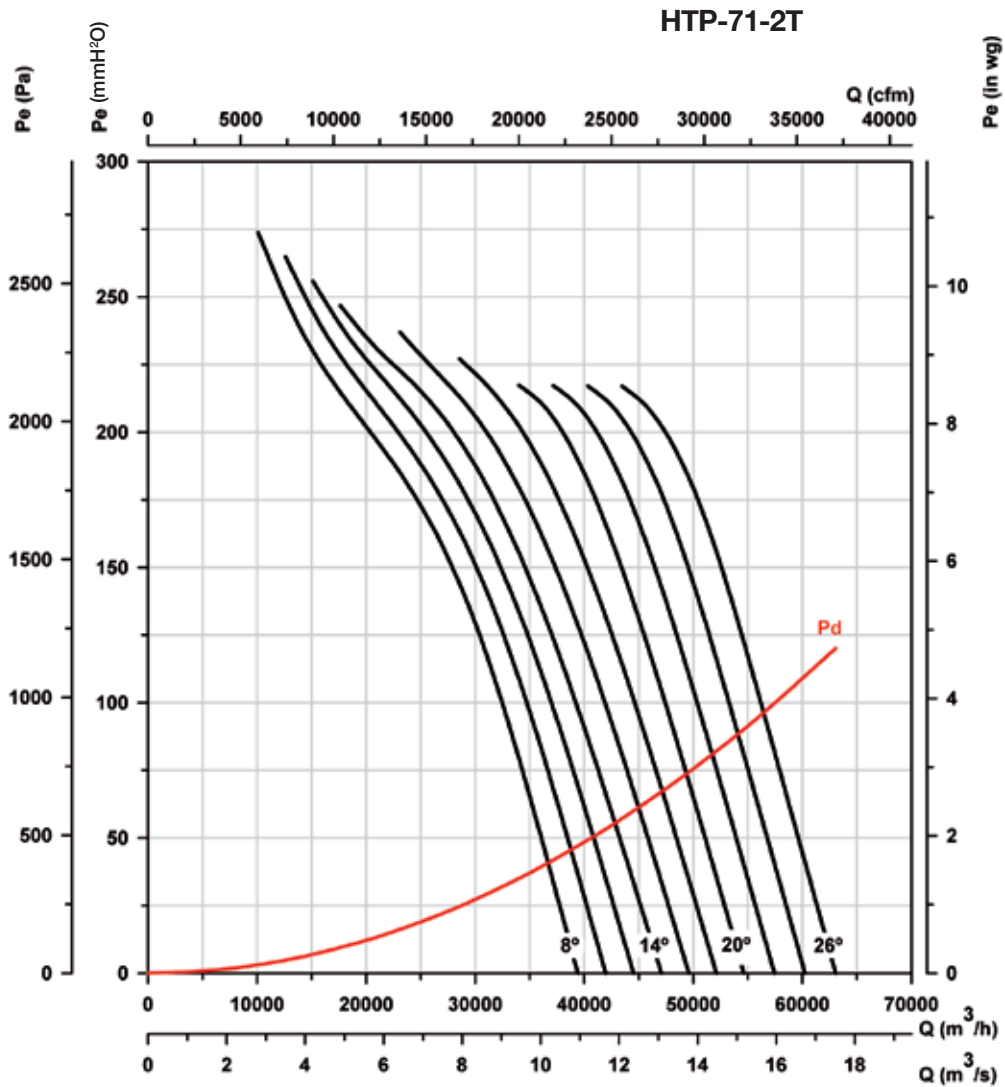

**Absorbed power**

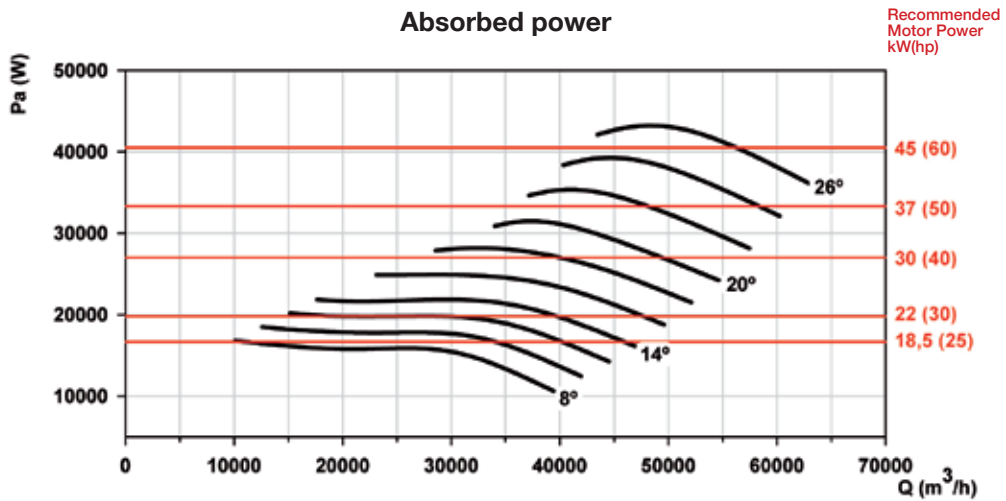

**Characteristic curves**

Q= Flow rate in m<sup>3</sup>/h, m<sup>3</sup>/s and cfm.

Pe= Static pressure in mm H<sub>2</sub>O, Pa and inwg.

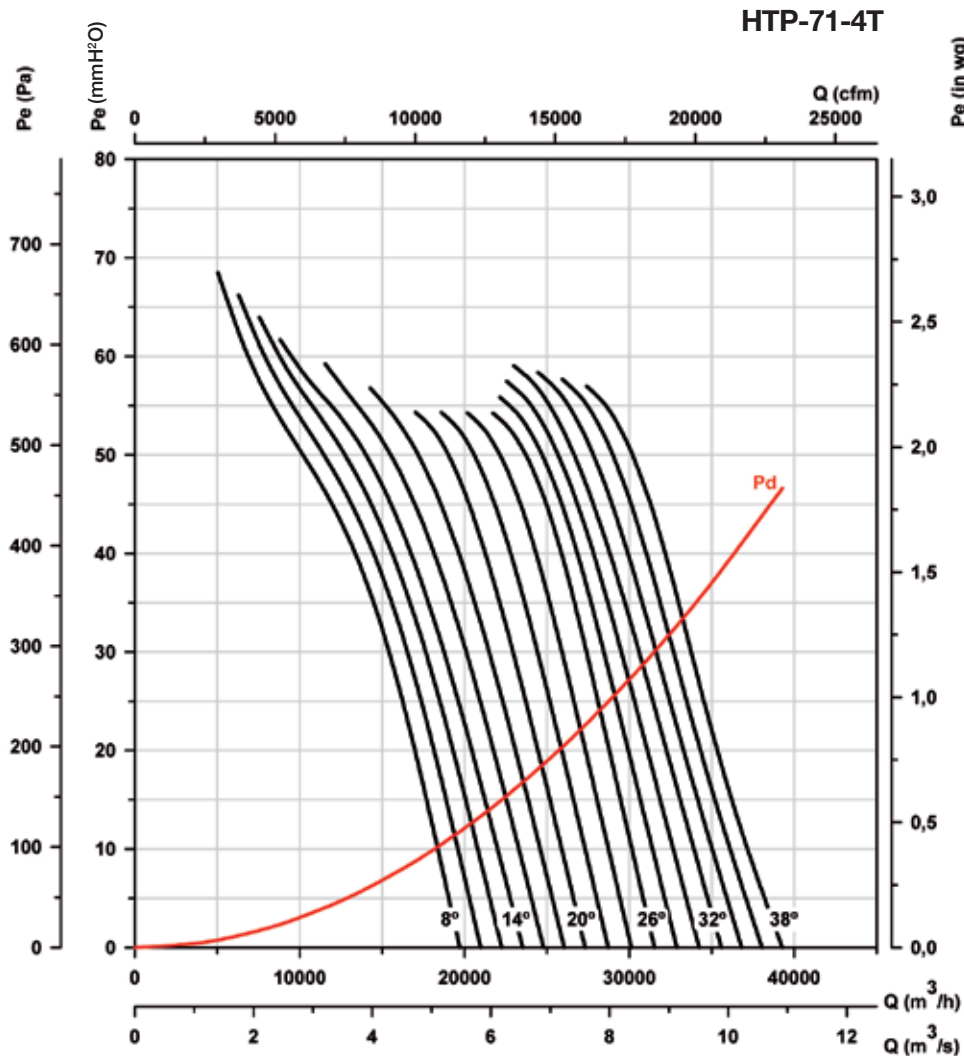

Absorbed power

Recommended Motor Power kW(hp)

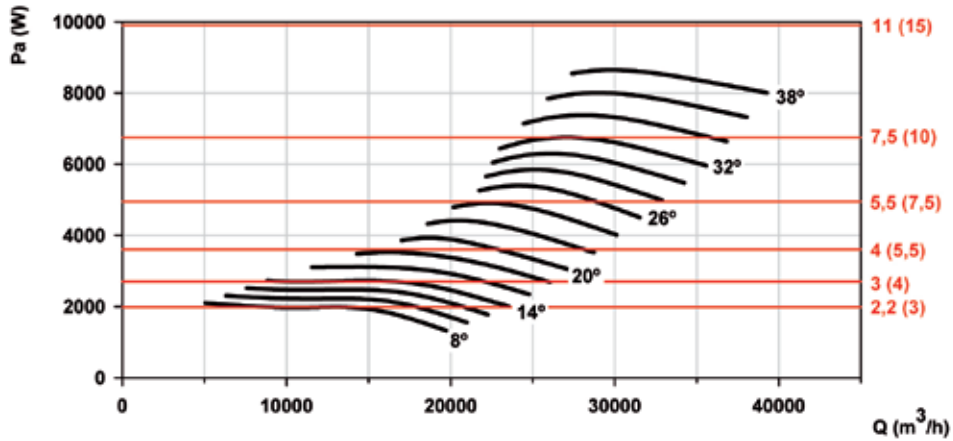

**Characteristic curves**

Q= Flow rate in m<sup>3</sup>/h, m<sup>3</sup>/s and cfm.

Pe= Static pressure in mm H<sub>2</sub>O, Pa and inwg.

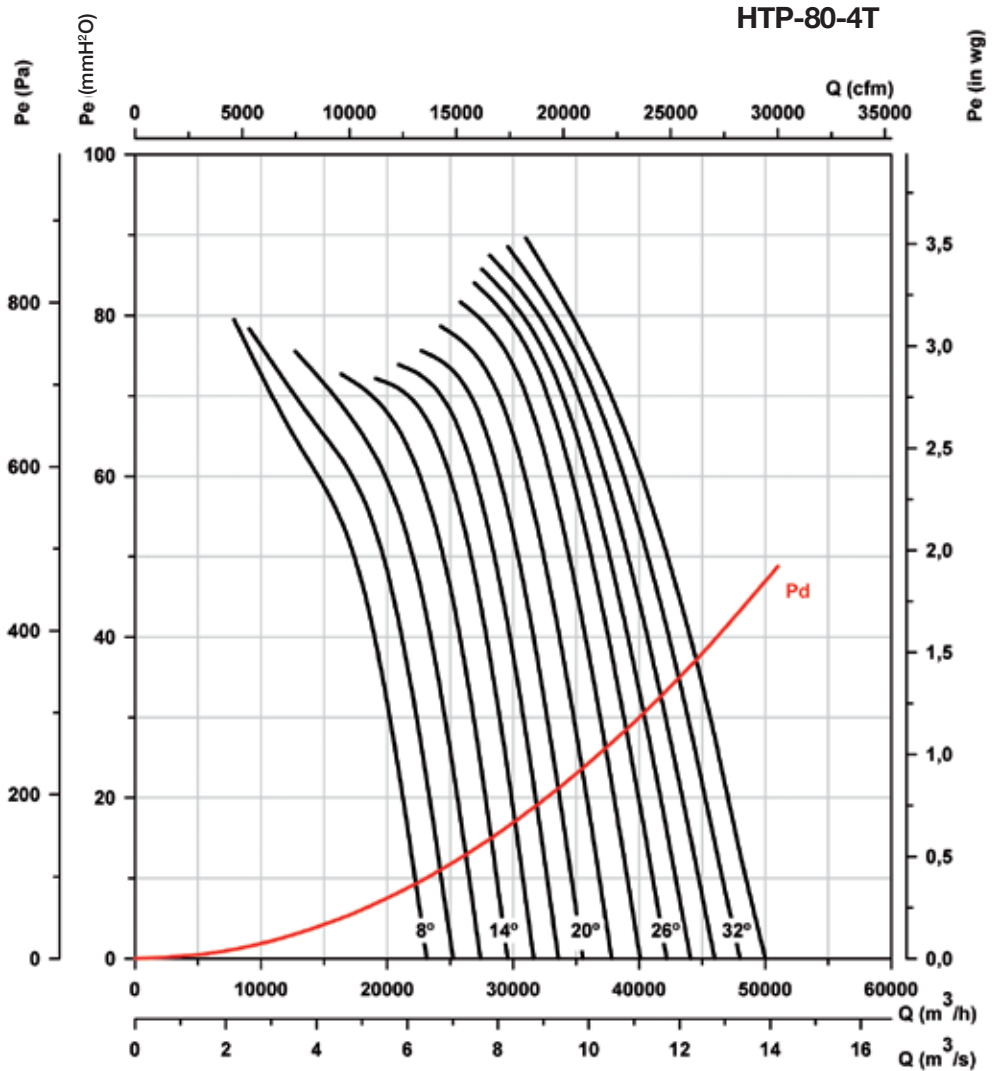

**Absorbed power**

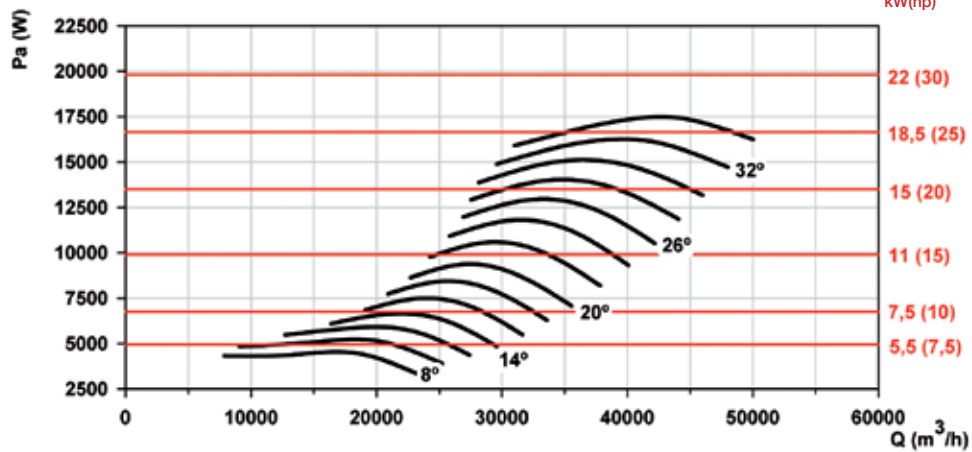

Recommended Motor Power kW(hp)

**Characteristic curves**

Q= Flow rate in m<sup>3</sup>/h, m<sup>3</sup>/s and cfm.

Pe= Static pressure in mm H<sub>2</sub>O, Pa and inwg.

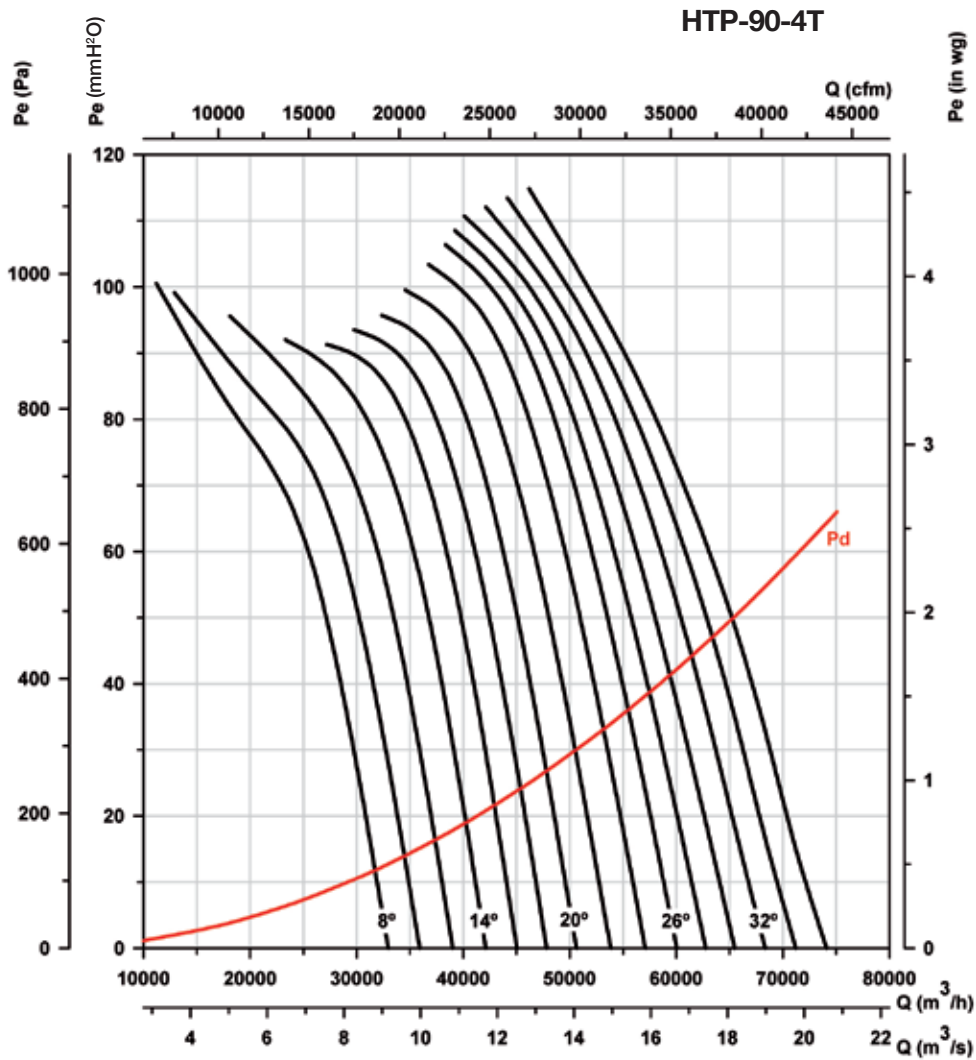

**Absorbed power**

Recommended Motor Power kW(hp)

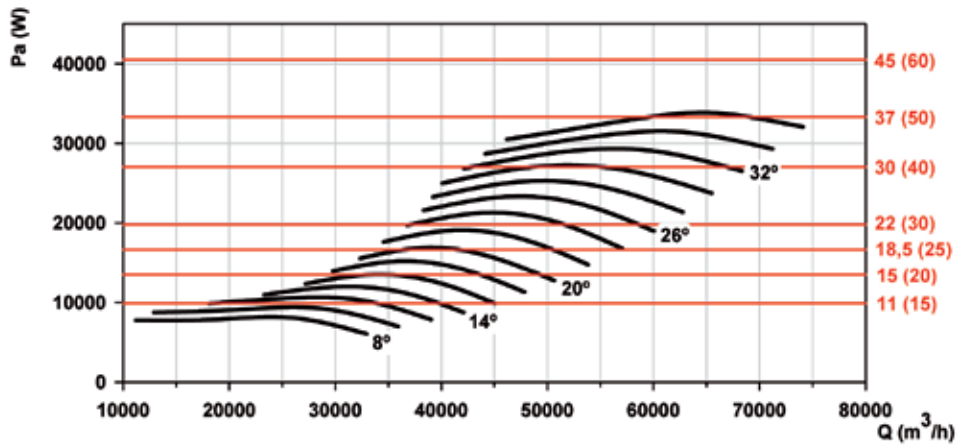



**Characteristic curves**

Q= Flow rate in m<sup>3</sup>/h, m<sup>3</sup>/s and cfm.

Pe= Static pressure in mm H<sub>2</sub>O, Pa and inwg.

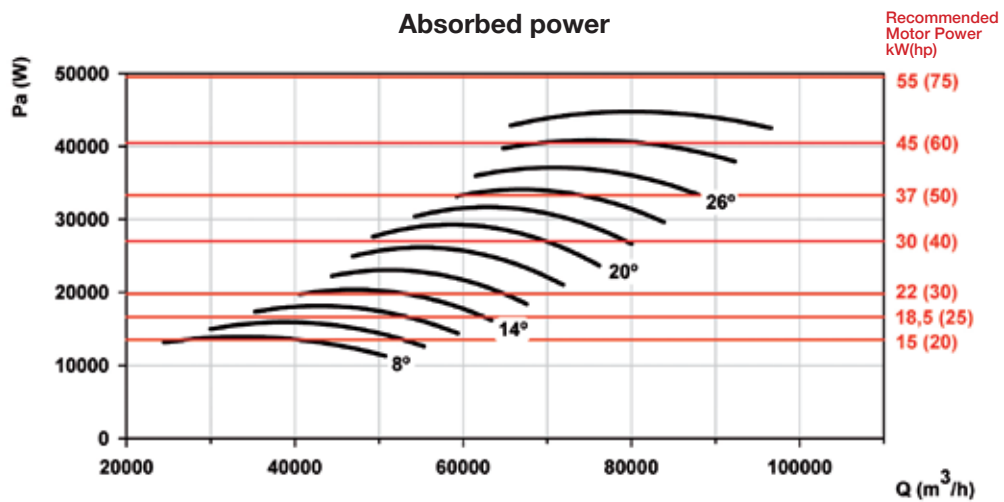
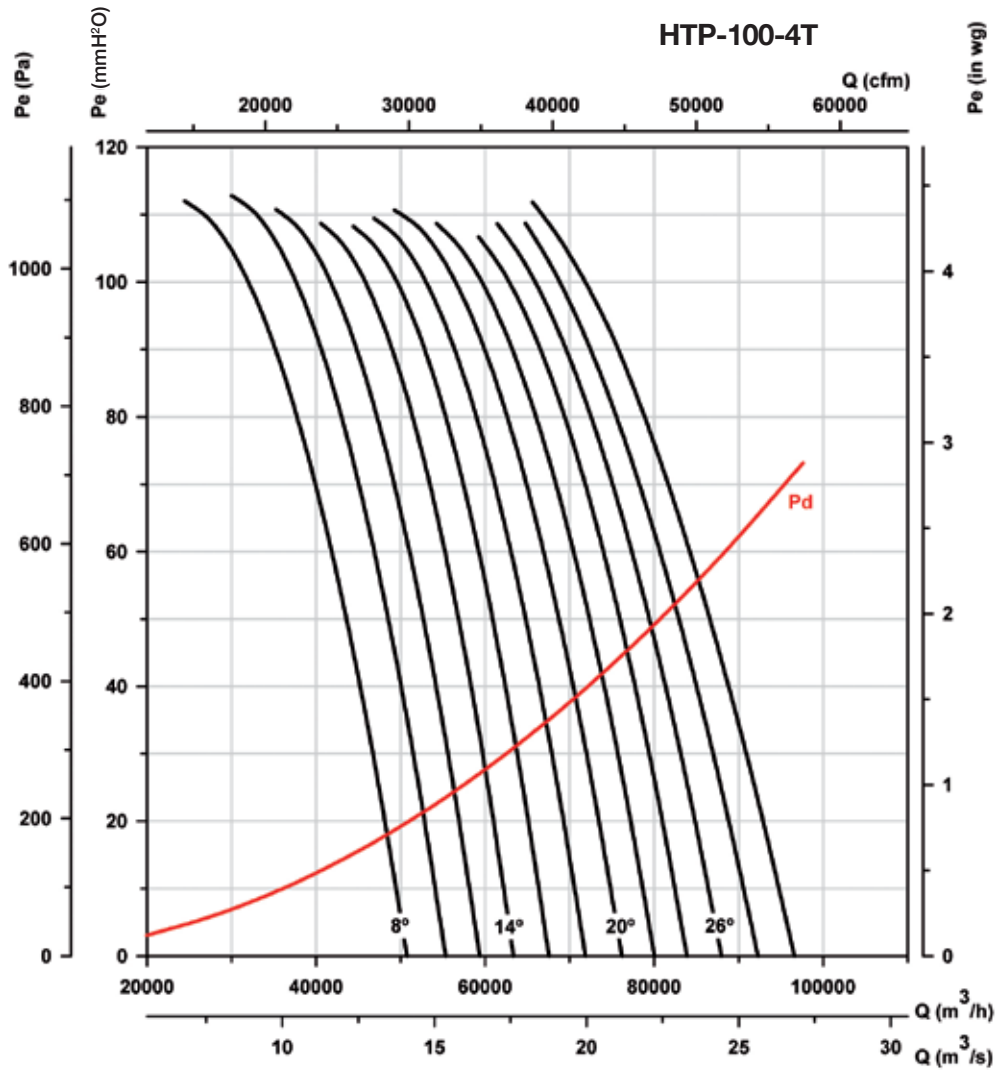

**Characteristic curves**

Q= Flow rate in m<sup>3</sup>/h, m<sup>3</sup>/s and cfm.

Pe= Static pressure in mm H<sub>2</sub>O, Pa and inwg.

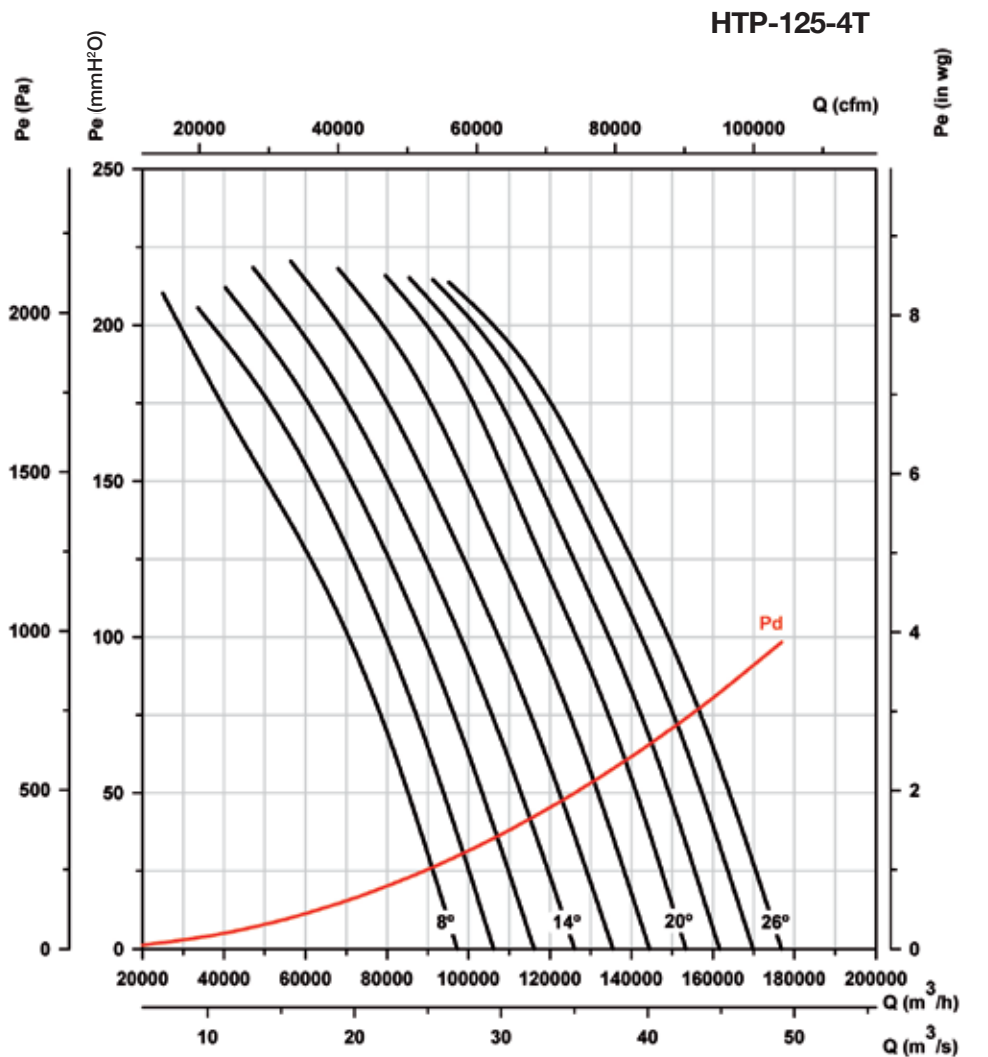

**Absorbed power**

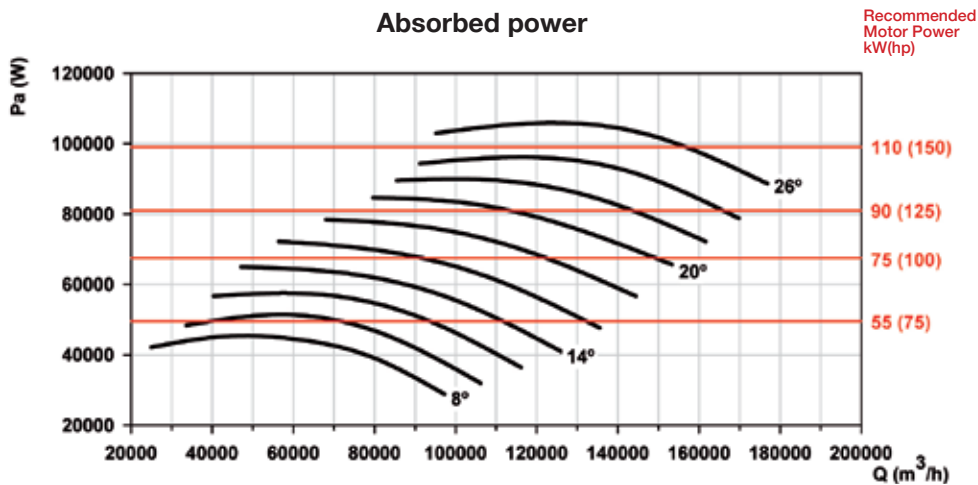

Recommended Motor Power kW(hp)

**Accessories**

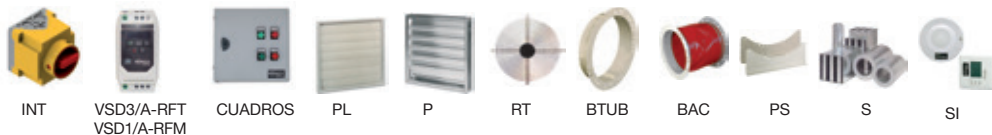

INT

VSD3/A-RFT  
VSD1/A-RFM

CUADROS

PL

P

RT

BTUB

BAC

PS

S

SI

# HGT HGTX

**HGT: Tubular axial fans with large diameters and direct drive motors.**  
**HGTX: Large diameter tubular axial fans with external motor.**

Tubular axial fans fitted with aluminium rotors with 3, 6 or 9 blades and different angles of inclination.

**Fan:**

- Airflow direction from Motor to Impeller.
- Rotors made of cast aluminium with 3, 6 or 9 blades with adjustable angle of inclination.
- Sheet steel tubular casing.
- HGT: The standard version has a short casing. The long cased version is fitted with an inspection hatch.
- HGTX: Standard long cased version fitted with an inspection hatch.



HGT



HGTX

**Motor:**

- IE3 efficiency motors for powers equal to or greater than 0.75kW except single-phase, 2-speed and 8-pole.
- Class F motors with ball bearings and IP55 protection.
- Multi voltage motor, special design valid for 220/380V 60Hz, 254/440V 60Hz, 265/460V 60Hz, 277/480V 60Hz.
- Operating temperature: -25 °C+ 50 °C (HGT), -25 °C+ 120 °C (HGTX)

**Finish:**

- Anti-corrosive finish of polyester resin polymerised at 190 °C, previously degreased with phosphate-free nanotechnological treatment.

**On request:**

- Airflow direction from Impeller to Motor.
- Rotors 100% reversible.
- Special windings for different voltages.
- ATEX-certified Category 2.
- HGT: Long cased fans fitted with an inspection hatch.
- Two-speed motors.

**Order code**

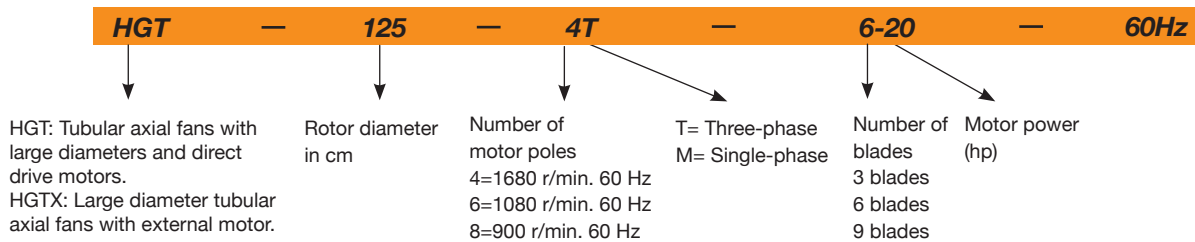

**Technical characteristics**



Model	Speed (r/min)	Max. admissible current (A)		Installed power (kW)	Maximum flow rate (m³/h)	Sound pressure level dB(A)	Approx. weight (Kg)		
		220-277V	380-480V				HGT	HGTX	
		Long	Short						
HGT-125-4T/3-10	HGTX-125-4T/3-10	1740	13.90	7.50	58150	88	227	194	358
HGT-125-4T/3-15	HGTX-125-4T/3-15	1750	20.90	11.00	77450	89	274	246	394
HGT-125-4T/3-20	HGTX-125-4T/3-20	1745	27.90	15.00	91400	91	285	257	405
HGT-125-4T/3-25	HGTX-125-4T/3-25	1765	35.10	18.50	98350	91	363	320	450
HGT-125-4T/3-30	HGTX-125-4T/3-30	1765	41.00	22.00	110500	92	363	320	450
HGT-125-4T/3-40	HGTX-125-4T/3-40	1770	57.10	30.00	120850	93	468	425	557
HGT-125-4T/3-50	HGTX-125-4T/3-50	1775	69.20	37.00	129000	94	551	495	622
HGT-125-4T/3-60	HGTX-125-4T/3-60	1775	80.90	45.00	140000	95	589	533	660
HGT-125-4T/6-20	HGTX-125-4T/6-20	1745	27.90	15.00	78300	89	294	266	414
HGT-125-4T/6-25	HGTX-125-4T/6-25	1765	35.10	18.50	92000	90	372	329	459
HGT-125-4T/6-30	HGTX-125-4T/6-30	1765	41.00	22.00	98100	90	372	329	459
HGT-125-4T/6-40	HGTX-125-4T/6-40	1770	57.10	30.00	117000	92	477	433	566
HGT-125-4T/6-50	HGTX-125-4T/6-50	1775	69.20	37.00	123700	93	560	504	631
HGT-125-4T/6-60	HGTX-125-4T/6-60	1775	80.90	45.00	136000	94	598	542	669
HGT-125-4T/6-75	HGTX-125-4T/6-75	1775	98.60	55.00	148000	95	614	564	700
HGT-125-4T/6-100	HGTX-125-4T/6-100	1775	134.00	75.00	161000	96	708	658	794
HGT-125-4T/9-25	HGTX-125-4T/9-25	1765	35.10	18.50	79750	88	381	338	468
HGT-125-4T/9-30	HGTX-125-4T/9-30	1765	41.00	22.00	97000	89	381	338	468

### Technical characteristics

Model	Speed (r/min)	Max. admissible current (A)		Installed power (kW)	Maximum flow rate (m <sup>3</sup> /h)	Sound pressure level dB(A)	Approx. weight (Kg)			
		220-277V	380-480V				HGT		HGTX	
							Long	Short		
HGT-125-4T/9-40	HGTX-125-4T/9-40	1770	57.10	30.00	111200	91	486	442	575	
HGT-125-4T/9-50	HGTX-125-4T/9-50	1775	69.20	37.00	118350	93	569	513	640	
HGT-125-4T/9-60	HGTX-125-4T/9-60	1775	80.90	45.00	127000	94	607	551	678	
HGT-125-4T/9-75	HGTX-125-4T/9-75	1775	98.60	55.00	142000	95	623	573	709	
HGT-125-4T/9-100	HGTX-125-4T/9-100	1775	134.00	75.00	155000	99	717	667	803	
HGT-125-6T/3-4	HGTX-125-6T/3-4	1120	12.70	7.33	3.00	46550	79	204	171	335
HGT-125-6T/3-5.5	HGTX-125-6T/3-5.5	1130	16.50	9.53	4.00	55300	80	209	176	340
HGT-125-6T/3-7.5	HGTX-125-6T/3-7.5	1145		11.50	5.50	64450	81	217	184	348
HGT-125-6T/3-10	HGTX-125-6T/3-10	1165		14.80	7.50	76400	83	297	269	417
HGT-125-6T/3-15	HGTX-125-6T/3-15	1165		21.90	11.00	87050	84	298	270	418
HGT-125-6T/3-20	HGTX-125-6T/3-20	1165		28.20	15.00	91700	85	407	364	494
HGT-125-6T/6-5.5	HGTX-125-6T/6-5.5	1130	16.50	9.53	4.00	51300	77	218	185	349
HGT-125-6T/6-7.5	HGTX-125-6T/6-7.5	1145		11.50	5.50	60300	77	226	193	357
HGT-125-6T/6-10	HGTX-125-6T/6-10	1165		14.80	7.50	72250	79	306	278	426
HGT-125-6T/6-15	HGTX-125-6T/6-15	1165		21.90	11.00	85450	81	307	279	427
HGT-125-6T/6-20	HGTX-125-6T/6-20	1165		28.20	15.00	92850	82	416	373	503
HGT-125-6T/6-25	HGTX-125-6T/6-25	1180		35.90	18.50	103000	84	449	405	538
HGT-125-6T/9-10	HGTX-125-6T/9-10	1165		14.80	7.50	68200	78	315	287	435
HGT-125-6T/9-15	HGTX-125-6T/9-15	1165		21.90	11.00	77550	81	316	288	436
HGT-125-6T/9-20	HGTX-125-6T/9-20	1165		28.20	15.00	92900	84	425	382	512
HGT-125-6T/9-25	HGTX-125-6T/9-25	1180		35.90	18.50	98700	85	458	414	547
HGT-125-6T/9-30	HGTX-125-6T/9-30	1175		42.40	22.00	104000	87	463	419	552
HGT-125-8T/3-3	HGTX-125-8T/3-3	865	9.53	5.50	2.20	48800	71	209	176	340
HGT-125-8T/3-4	HGTX-125-8T/3-4	865	12.82	7.40	3.00	54900	71	216	183	347
HGT-125-8T/3-5.5	HGTX-125-8T/3-5.5	860	16.11	9.30	4.00	62100	73	249	221	369
HGT-125-8T/3-7.5	HGTX-125-8T/3-7.5	850		12.70	5.50	69500	75	262	234	382
HGT-125-8T/6-3	HGTX-125-8T/6-3	865	9.53	5.50	2.20	45700	69	218	185	349
HGT-125-8T/6-4	HGTX-125-8T/6-4	865	12.82	7.40	3.00	51800	71	225	192	356
HGT-125-8T/6-5.5	HGTX-125-8T/6-5.5	860	16.11	9.30	4.00	61500	72	258	230	378
HGT-125-8T/6-7.5	HGTX-125-8T/6-7.5	850		12.70	5.50	67500	73	271	243	391
HGT-125-8T/6-10	HGTX-125-8T/6-10	860		17.00	7.50	75500	75	301	273	421
HGT-125-8T/9-4	HGTX-125-8T/9-4	865	12.82	7.40	3.00	48200	70	234	201	365
HGT-125-8T/9-5.5	HGTX-125-8T/9-5.5	860	16.11	9.30	4.00	55200	73	267	239	387
HGT-125-8T/9-7.5	HGTX-125-8T/9-7.5	850		12.70	5.50	67000	75	280	252	400
HGT-125-8T/9-10	HGTX-125-8T/9-10	860		17.00	7.50	74750	76	310	282	430
HGT-125-8T/9-15	HGTX-125-8T/9-15	865		21.70	11.00	80800	79	372	329	459
HGT-140-6T/3-4		1150	12.70	7.33	3.00	51000	82	251	214	
HGT-140-6T/3-5.5		1150	16.50	9.53	4.00	56700	83	258	221	
HGT-140-6T/3-7.5		1145		11.50	5.50	67900	84	266	229	
HGT-140-6T/3-10		1165		14.80	7.50	80100	85	355	316	
HGT-140-6T/3-15		1165		21.90	11.00	96900	86	356	317	
HGT-140-6T/3-20		1165		28.20	15.00	106000	88	463	413	
HGT-140-6T/6-5.5		1150	16.50	9.53	4.00	58000	82	268	231	
HGT-140-6T/6-7.5		1145		11.50	5.50	66000	84	276	239	
HGT-140-6T/6-10		1165		14.80	7.50	80700	85	365	326	
HGT-140-6T/6-15		1165		21.90	11.00	96700	86	366	327	
HGT-140-6T/6-20		1165		28.20	15.00	104000	87	472	423	
HGT-140-6T/6-25		1180		35.90	18.50	115000	88	506	457	
HGT-140-6T/6-30		1175		42.40	22.00	119000	89	511	462	
HGT-140-6T/9-10		1165		14.80	7.50	70000	84	374	335	
HGT-140-6T/9-15		1165		21.90	11.00	86000	86	375	336	
HGT-140-6T/9-20		1165		28.20	15.00	97500	87	482	432	
HGT-140-6T/9-25		1180		35.90	18.50	111000	88	515	467	
HGT-140-6T/9-30		1175		42.40	22.00	118500	89	520	472	
HGT-140-6T/9-40		1180		55.40	30.00	132000	91	676	614	
HGT-140-6T/9-50		1180		67.20	37.00	139000	92	693	638	
HGT-140-8T/3-3		865	9.53	5.50	2.20	50000	78	258	221	
HGT-140-8T/3-4		865	12.82	7.40	3.00	57000	78	265	228	

**Technical characteristics**

Model	Speed (r/min)	Max. admissible current (A)		Installed power (kW)	Maximum flow rate (m <sup>3</sup> /h)	Sound pressure level dB(A)	Approx. weight (Kg)	
		220-277V	380-480V				HGT	HGTX
							Long	Short
HGT-140-8T/3-5.5	860	16.11	9.30	4.00	65400	79	307	268
HGT-140-8T/3-7.5	850		12.70	5.50	77500	81	320	281
HGT-140-8T/3-10	860		17.00	7.50	86000	82	350	311
HGT-140-8T/6-3	865	9.53	5.50	2.20	47500	78	268	231
HGT-140-8T/6-4	865	12.82	7.40	3.00	57600	79	275	238
HGT-140-8T/6-5.5	860	16.11	9.30	4.00	65200	80	317	278
HGT-140-8T/6-7.5	850		12.70	5.50	73300	81	330	291
HGT-140-8T/6-10	860		17.00	7.50	82200	82	360	321
HGT-140-8T/6-15	865		21.70	11.00	94200	83	419	370
HGT-140-8T/9-4	865	12.82	7.40	3.00	47200	79	284	247
HGT-140-8T/9-5.5	860	16.11	9.30	4.00	64400	79	326	287
HGT-140-8T/9-7.5	850		12.70	5.50	69200	81	339	300
HGT-140-8T/9-10	860		17.00	7.50	78700	82	369	330
HGT-140-8T/9-15	865		21.70	11.00	94300	83	429	379
HGT-140-8T/9-20	890		31.70	15.00	103000	86	485	437
HGT-160-6T/3-5.5	1150	16.50	9.53	4.00	66000	81	327	275
HGT-160-6T/3-7.5	1145		11.50	5.50	76100	82	335	283
HGT-160-6T/3-10	1165		14.80	7.50	84000	83	428	374
HGT-160-6T/3-15	1165		21.90	11.00	102000	85	429	375
HGT-160-6T/3-20	1165		28.20	15.00	127000	86	549	480
HGT-160-6T/3-25	1180		35.90	18.50	136700	87	583	513
HGT-160-6T/3-30	1175		42.40	22.00	145000	89	588	518
HGT-160-6T/6-10	1165		14.80	7.50	75000	83	439	385
HGT-160-6T/6-15	1165		21.90	11.00	93500	85	440	386
HGT-160-6T/6-20	1165		28.20	15.00	120500	86	559	490
HGT-160-6T/6-25	1180		35.90	18.50	130000	87	593	524
HGT-160-6T/6-30	1175		42.40	22.00	140000	88	598	529
HGT-160-6T/6-40	1180		55.40	30.00	158000	89	771	672
HGT-160-6T/6-50	1180		67.20	37.00	171000	91	784	699
HGT-160-6T/9-15	1165		21.90	11.00	87000	85	450	396
HGT-160-6T/9-20	1165		28.20	15.00	104000	86	569	500
HGT-160-6T/9-25	1180		35.90	18.50	127000	87	603	534
HGT-160-6T/9-30	1175		42.40	22.00	135000	88	608	539
HGT-160-6T/9-40	1180		55.40	30.00	147000	89	781	682
HGT-160-6T/9-50	1180		67.20	37.00	165000	90	794	710
HGT-160-6T/9-60	1180		84.40	45.00	177000	91	1019	920
HGT-160-6T/9-75	1190		103.00	55.00	193000	92	1077	978
HGT-160-6T/9-100	1190		139.00	75.00	207500	93	1232	1133
HGT-160-8T/3-3	865	9.53	5.50	2.20	54000	76	327	275
HGT-160-8T/3-4	865	12.82	7.40	3.00	57500	77	334	282
HGT-160-8T/3-5.5	860	16.11	9.30	4.00	74000	79	380	326
HGT-160-8T/3-7.5	850		12.70	5.50	83500	80	393	339
HGT-160-8T/3-10	860		17.00	7.50	97500	81	423	369
HGT-160-8T/3-15	865		21.70	11.00	115000	83	496	427
HGT-160-8T/6-4	865	12.82	7.40	3.00	70900	76	344	292
HGT-160-8T/6-5.5	860	16.11	9.30	4.00	84500	77	391	337
HGT-160-8T/6-7.5	850		12.70	5.50	77000	79	404	350
HGT-160-8T/6-10	860		17.00	7.50	95000	80	434	380
HGT-160-8T/6-15	865		21.70	11.00	109000	82	506	437
HGT-160-8T/6-20	890		31.70	15.00	123000	83	563	494
HGT-160-8T/6-25	875		35.85	18.50	130000	84	641	542
HGT-160-8T/9-7.5	850		12.70	5.50	70000	79	414	360
HGT-160-8T/9-10	860		17.00	7.50	87000	80	444	390
HGT-160-8T/9-15	865		21.70	11.00	103000	82	516	447
HGT-160-8T/9-20	890		31.70	15.00	117000	83	573	504
HGT-160-8T/9-25	875		35.85	18.50	133000	84	651	552
HGT-160-8T/9-30	875		41.60	22.00	140000	85	666	567
HGT-160-8T/9-40	880		60.79	30.00	151000	86	724	640

**Acoustic characteristics**

The indicated values are determined by measuring the sound pressure level and sound power in dB(A) obtained in a free field at a distance equivalent to twice the size of the fan plus the rotor diameter, with a minimum of 1.5 m.

Sound power spectrum Lw(A) in dB(A) per Hz frequency band

Model	63	125	250	500	1000	2000	4000	8000	Model	63	125	250	500	1000	2000	4000	8000
125-4T/3-10	70	76	88	98	98	94	86	82	140-6T/9-10	66	84	93	92	91	87	78	73
125-4T/3-15	71	77	89	99	99	95	87	83	140-6T/9-15	67	85	94	93	92	88	79	74
125-4T/3-20	72	78	90	100	100	96	88	84	140-6T/9-20	69	87	96	95	94	90	81	76
125-4T/3-25	73	79	91	101	101	97	89	85	140-6T/9-25	70	88	97	96	95	91	82	77
125-4T/3-30	74	80	92	102	102	98	90	86	140-6T/9-30	70	88	97	96	95	91	82	77
125-4T/3-40	75	81	93	103	103	99	91	87	140-6T/9-40	71	89	98	97	96	92	83	78
125-4T/3-50	76	82	94	104	104	100	92	88	140-6T/9-50	74	92	101	100	99	95	86	81
125-4T/3-60	77	83	95	105	105	101	93	89	140-8T/3-3	60	70	78	83	82	81	68	63
125-4T/6-20	66	74	90	97	99	94	88	84	140-8T/3-4	64	74	82	87	86	85	72	67
125-4T/6-25	67	75	91	98	100	95	89	85	140-8T/3-5.5	65	75	83	88	87	86	73	68
125-4T/6-30	68	76	92	99	101	96	90	86	140-8T/3-7.5	66	76	84	89	88	87	74	69
125-4T/6-40	69	77	93	100	102	97	91	87	140-8T/3-10	68	78	86	91	90	89	76	71
125-4T/6-50	71	79	95	102	104	99	93	89	140-8T/6-3	61	73	82	86	84	78	68	65
125-4T/6-60	72	80	96	103	105	100	94	90	140-8T/6-4	63	75	84	88	86	80	70	67
125-4T/6-75	72	80	96	103	105	100	94	90	140-8T/6-5.5	64	76	85	89	87	81	71	68
125-4T/6-100	74	82	98	105	107	102	96	92	140-8T/6-7.5	65	77	86	90	88	82	72	69
125-4T/9-25	66	74	91	97	98	93	88	84	140-8T/6-10	66	78	87	91	89	83	73	70
125-4T/9-30	67	75	92	98	99	94	89	85	140-8T/6-15	68	80	89	93	91	85	75	72
125-4T/9-40	68	76	93	99	100	95	90	86	140-8T/9-4	61	72	83	88	86	82	72	67
125-4T/9-50	70	78	95	101	102	97	92	88	140-8T/9-5.5	62	73	84	89	87	83	73	68
125-4T/9-60	72	80	97	103	104	99	94	90	140-8T/9-7.5	63	74	85	90	88	84	74	69
125-4T/9-75	72	80	97	103	104	99	94	90	140-8T/9-10	64	75	86	91	89	85	75	70
125-4T/9-100	74	82	99	105	106	101	96	92	140-8T/9-15	65	76	87	92	90	86	76	71
125-6T/3-4	64	72	84	88	86	81	72	68	140-8T/9-20	67	78	89	94	92	88	78	73
125-6T/3-5.5	66	74	86	90	88	83	74	70	160-6T/3-5.5	67	77	85	90	89	88	75	70
125-6T/3-7.5	67	75	87	91	89	84	75	71	160-6T/3-7.5	68	78	86	91	90	89	76	71
125-6T/3-10	68	76	88	92	90	85	76	72	160-6T/3-10	69	79	87	92	91	90	77	72
125-6T/3-15	69	77	89	93	91	86	77	73	160-6T/3-15	70	80	88	93	92	91	78	73
125-6T/3-20	71	79	91	95	93	88	79	75	160-6T/3-20	72	82	90	95	94	93	80	75
125-6T/6-5.5	59	68	81	84	85	82	71	67	160-6T/3-25	73	83	91	96	95	94	81	76
125-6T/6-7.5	60	69	82	85	86	83	72	68	160-6T/3-30	74	84	92	97	96	95	82	77
125-6T/6-10	61	70	83	86	87	84	73	69	160-6T/6-10	67	82	91	93	90	84	76	72
125-6T/6-15	63	72	85	88	89	86	75	71	160-6T/6-15	68	83	92	94	91	85	77	73
125-6T/6-20	65	74	87	90	91	88	77	73	160-6T/6-20	70	85	94	96	93	87	79	75
125-6T/6-25	66	75	88	91	92	89	78	74	160-6T/6-25	71	86	95	97	94	88	80	76
125-6T/9-10	57	67	82	86	85	84	73	69	160-6T/6-30	71	86	95	97	94	88	80	76
125-6T/9-15	59	69	84	88	87	86	75	71	160-6T/6-40	72	87	96	98	95	89	81	77
125-6T/9-20	62	72	87	91	90	89	78	74	160-6T/6-50	74	89	98	100	97	91	83	79
125-6T/9-25	64	74	89	93	92	91	80	76	160-6T/9-15	67	85	94	93	92	88	79	74
125-6T/9-30	66	76	91	95	94	93	82	78	160-6T/9-20	68	86	95	94	93	89	80	75
125-8T/3-3	56	63	74	78	77	70	61	57	160-6T/9-25	69	87	96	95	94	90	81	76
125-8T/3-4	59	66	77	81	80	73	64	60	160-6T/9-30	70	88	97	96	95	91	82	77
125-8T/3-5.5	60	67	78	82	81	74	65	61	160-6T/9-40	71	89	98	97	96	92	83	78
125-8T/3-7.5	62	69	80	84	83	76	67	63	160-6T/9-50	72	90	99	98	97	93	84	79
125-8T/6-3	53	61	73	78	77	72	61	57	160-6T/9-60	72	90	99	98	97	93	84	79
125-8T/6-4	54	62	74	79	78	73	62	58	160-6T/9-75	73	91	100	99	98	94	85	80
125-8T/6-5.5	56	64	76	81	80	75	64	60	160-6T/9-100	75	93	102	101	100	96	87	82
125-8T/6-7.5	58	66	78	83	82	77	66	62	160-8T/3-3	61	71	79	84	83	82	69	64
125-8T/6-10	59	67	79	84	83	78	67	63	160-8T/3-4	63	73	81	86	85	84	71	66
125-8T/9-4	51	62	72	78	79	74	63	59	160-8T/3-5.5	64	74	82	87	86	85	72	67
125-8T/9-5.5	53	64	74	80	81	76	65	61	160-8T/3-7.5	65	75	83	88	87	86	73	68
125-8T/9-7.5	56	67	77	83	84	79	68	64	160-8T/3-10	66	76	84	89	88	87	74	69
125-8T/9-10	58	69	79	85	86	81	70	66	160-8T/3-15	68	78	86	91	90	89	76	71
125-8T/9-15	59	70	80	86	87	82	71	67	160-8T/6-4	60	75	84	86	83	77	69	65
140-6T/3-4	66	76	84	89	88	87	74	74	160-8T/6-5.5	61	76	85	87	84	78	70	66
140-6T/3-5.5	69	79	87	92	91	90	77	77	160-8T/6-7.5	62	77	86	88	85	79	71	67
140-6T/3-7.5	69	79	87	92	91	90	77	77	160-8T/6-10	63	78	87	89	86	80	72	68
140-6T/3-10	70	80	88	93	92	91	78	78	160-8T/6-15	65	80	89	91	88	82	74	70
140-6T/3-15	71	81	89	94	93	92	79	79	160-8T/6-20	66	81	90	92	89	83	75	71
140-6T/3-20	73	83	91	96	95	94	81	81	160-8T/6-25	68	83	92	94	91	85	77	73
140-6T/6-5.5	66	81	90	92	89	83	75	71	160-8T/9-7.5	60	78	87	86	85	81	72	67
140-6T/6-7.5	67	82	91	93	90	84	76	72	160-8T/9-10	62	80	89	88	87	83	74	69
140-6T/6-10	68	83	92	94	91	85	77	73	160-8T/9-15	63	81	90	89	88	84	75	70
140-6T/6-15	69	84	93	95	92	86	78	74	160-8T/9-20	64	82	91	90	89	85	76	71
140-6T/6-20	71	86	95	97	94	88	80	76	160-8T/9-25	65	83	92	91	90	86	77	72
140-6T/6-25	72	87	96	98	95	89	81	77	160-8T/9-30	66	84	93	92	91	87	78	73
140-6T/6-30	73	88	97	99	96	90	82	78	160-8T/9-40	68	86	95	94	93	89	80	75

**Accessories**



Dimensions mm

HGT

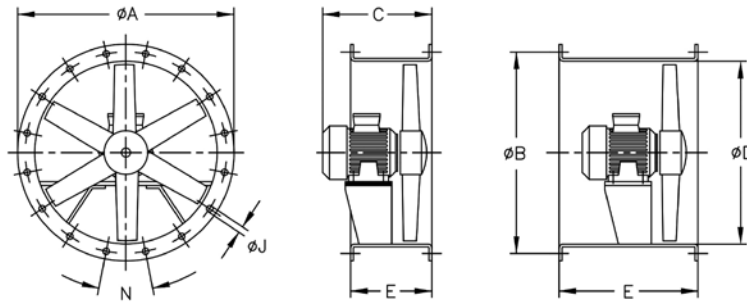

Model	ØA	ØB	C (Consult motor construction size)							ØD	E*		ØJ	N
			132	160	180	200	225	250	280		Short (STD)	long		
HGT-125	1365	1320	586	-	-	-	-	-	-	1250	500	700	15	20x18°
HGT-125	1365	1320	-	700	-	-	-	-	-	1250	500	700	15	20x18°
HGT-125	1365	1320	-	-	765	825	-	-	-	1250	700	900	15	20x18°
HGT-125	1365	1320	-	-	-	-	910	-	-	1250	700	1000	15	20x18°
HGT-125	1365	1320	-	-	-	-	-	985	-	1250	700	1000	15	20x18°
HGT-125	1365	1320	-	-	-	-	-	-	1190	1250	700	1200	15	20x18°
HGT-140	1515	1470	586	-	-	-	-	-	-	1400	400	650	15	20x18°
HGT-140	1515	1470	-	700	-	-	-	-	-	1400	450	700	15	20x18°
HGT-140	1515	1470	-	-	765	825	-	-	-	1400	550	900	15	20x18°
HGT-140	1515	1470	-	-	-	-	910	-	-	1400	550	1000	15	20x18°
HGT-140	1515	1470	-	-	-	-	-	985	-	1400	600	1000	15	20x18°
HGT-160	1735	1680	586	-	-	-	-	-	-	1600	400	650	19	24x15°
HGT-160	1735	1680	-	700	-	-	-	-	-	1600	450	700	19	24x15°
HGT-160	1735	1680	-	-	765	825	-	-	-	1600	550	900	19	24x15°
HGT-160	1735	1680	-	-	-	-	910	-	-	1600	550	1000	19	24x15°
HGT-160	1735	1680	-	-	-	-	-	985	-	1600	600	1000	19	24x15°
HGT-160	1735	1680	-	-	-	-	-	-	1190	1600	700	1200	19	24x15°

\* Standard version supplied with short casing. Long casing with inspection hatch available on request.

Motor construction sizes depending on power

Poles	r/min	hp	3	4	5.5	7.5	10	15	20	25	30	40	50	60	75	100
4T	1500	-	-	-	-	-	132	160	160	180	180	200	225	225	250	280
6T	1000	-	132	132	132	160	160	160	180	200	200	225	250	280	280	280
8T	750	-	132	132	160	160	160	180	200	225	225	250	-	-	-	-

HGTX

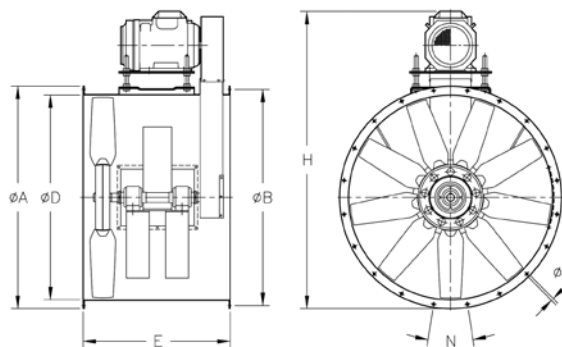

Model	ØA	ØB	ØD	E	H (Consult motor construction size)							ØJ	N	
					132	160	180	200	225	250	280			
HGT-X 125	1365	1320	1250	900	1743	1815	1850	-	-	-	-	-	15	20x18°
HGT-X 125	1365	1320	1250	960	-	-	-	1930	1995	-	-	-	15	20x18°
HGT-X 125	1365	1320	1250	1100	-	-	-	-	-	2060	-	-	15	20x18°
HGT-X 125	1365	1320	1250	1100	-	-	-	-	-	-	2090	-	15	20x18°

Motor construction sizes depending on power

Poles	r/min	hp	3	4	5.5	7.5	10	15	20	25	30	40	50	60	75	100
4T	1500	-	-	-	-	-	132	160	160	180	180	200	225	225	250	280
6T	1000	-	132	132	132	160	160	160	180	200	200	225	250	280	280	280
8T	750	-	132	132	160	160	160	180	200	225	225	250	-	-	-	-

## SELECTION EXAMPLE

### Characteristic curves

Q= Flow rate in m<sup>3</sup>/h, m<sup>3</sup>/s and cfm.

Pe= Static pressure in mmH<sub>2</sub>O, Pa and inwg.

**Rotor diameter (cm): 125**

**Number of poles: 8**

**Number of blades: 3**

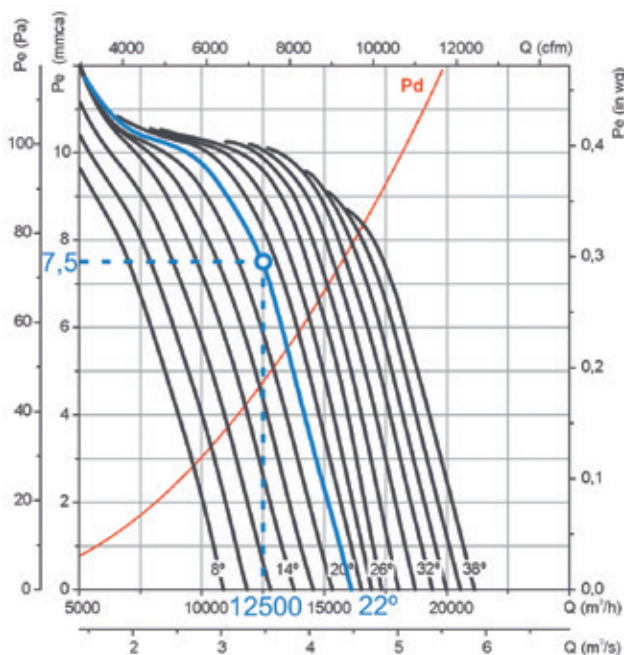

### Starting data

- Working point:
- Flow rate: 12,500 m<sup>3</sup>/h
- Load loss: 7.5 mm c.a.

### Equipment selection steps

#### On the pressure graph:

1. Mark the working point defined by the flow rate (12,500 m<sup>3</sup>/h) and the load loss (7.5 mm H<sub>2</sub>O).
2. Select the nearest equipment curve above the working point. In this case, a blade angle curve of 22° is obtained.

#### On the power graph:

3. Mark the working point defined by the working flow rate (12,500 m<sup>3</sup>/h) and the selected blade angle curve (22°).
4. Read the absorbed power on the left power axis. Pa= 560 W at the working point.
5. Find the nearest straight red line above the working point. The installed motor power is given on the right side of the graph. In this case, 0.75 kW or 1 hp.

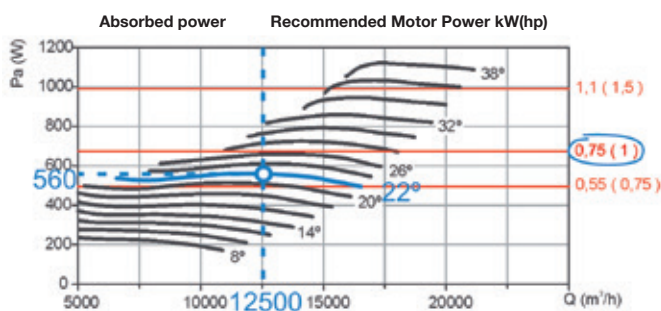

## ORDER CODE EXAMPLE

**HGT** — **125** — **8T** — **3** — **1** — **22**

HGT: Tubular axial fans with large diameters and direct drive motors.

HGTX: Large diameter tubular axial fans with external motor.

Rotor diameter in cm

Number of motor poles  
4=1680 r/min. 60 Hz  
6=1080 r/min. 60 Hz  
8=900 r/min. 60 Hz

T= Three-phase  
M=Single-phase

Number of blades  
3 blades  
6 blades  
9 blades

Motor power (hp)

Blade inclination angle



**Characteristic curves**

Q= Flow rate in m<sup>3</sup>/h, m<sup>3</sup>/s and cfm.

Pe= Static pressure in mmH<sub>2</sub>O, Pa and inwg.

**Rotor diameter (cm): 125**

**Number of poles: 4**

**Number of blades: 3**

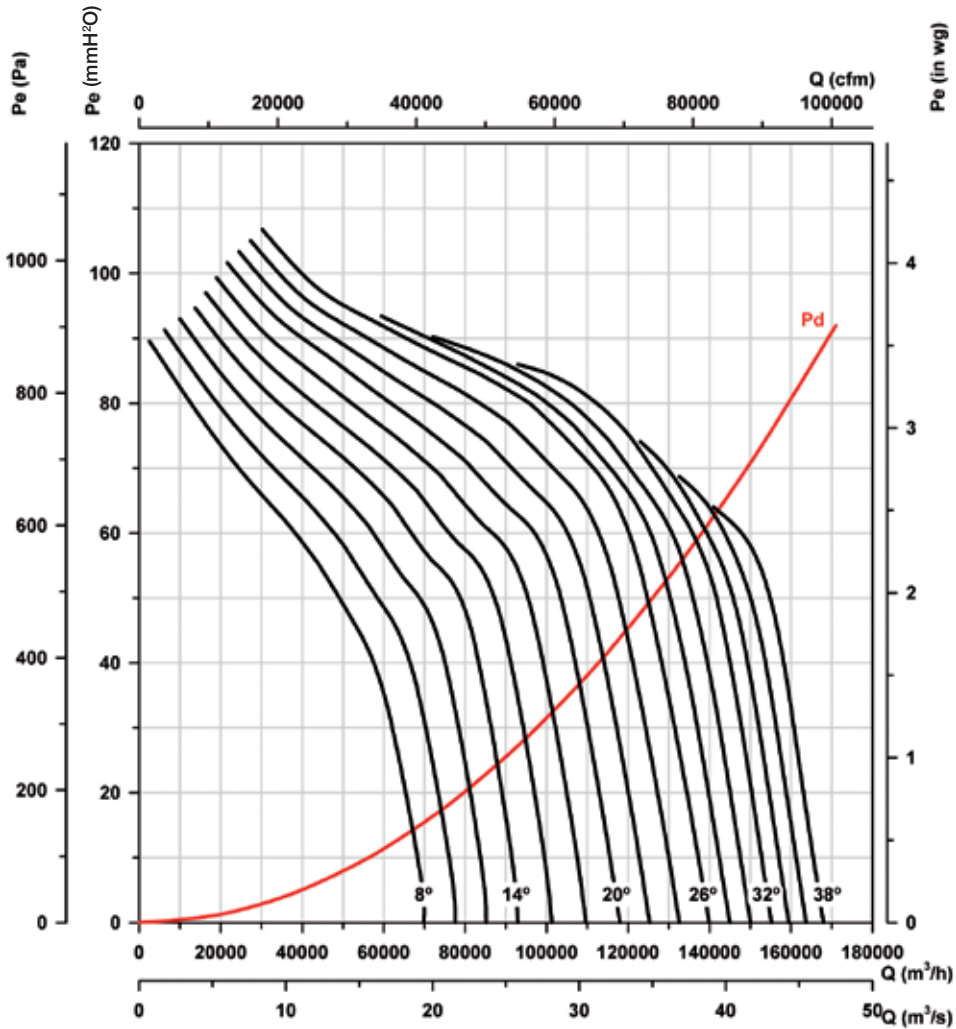

**Absorbed power**

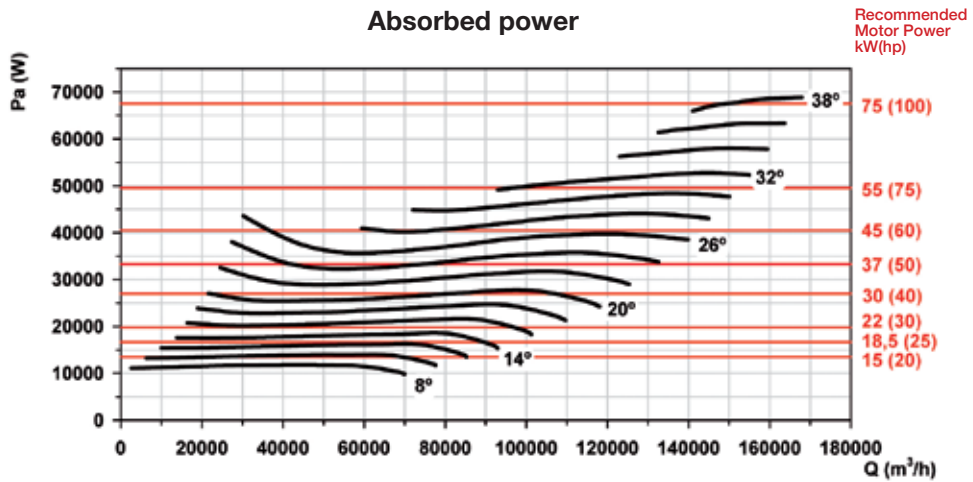

**Characteristic curves**

Q= Flow rate in m<sup>3</sup>/h, m<sup>3</sup>/s and cfm.

Pe= Static pressure in mmH<sub>2</sub>O, Pa and inwg.

**Rotor diameter (cm): 125**

**Number of poles: 4**

**Number of blades: 6**

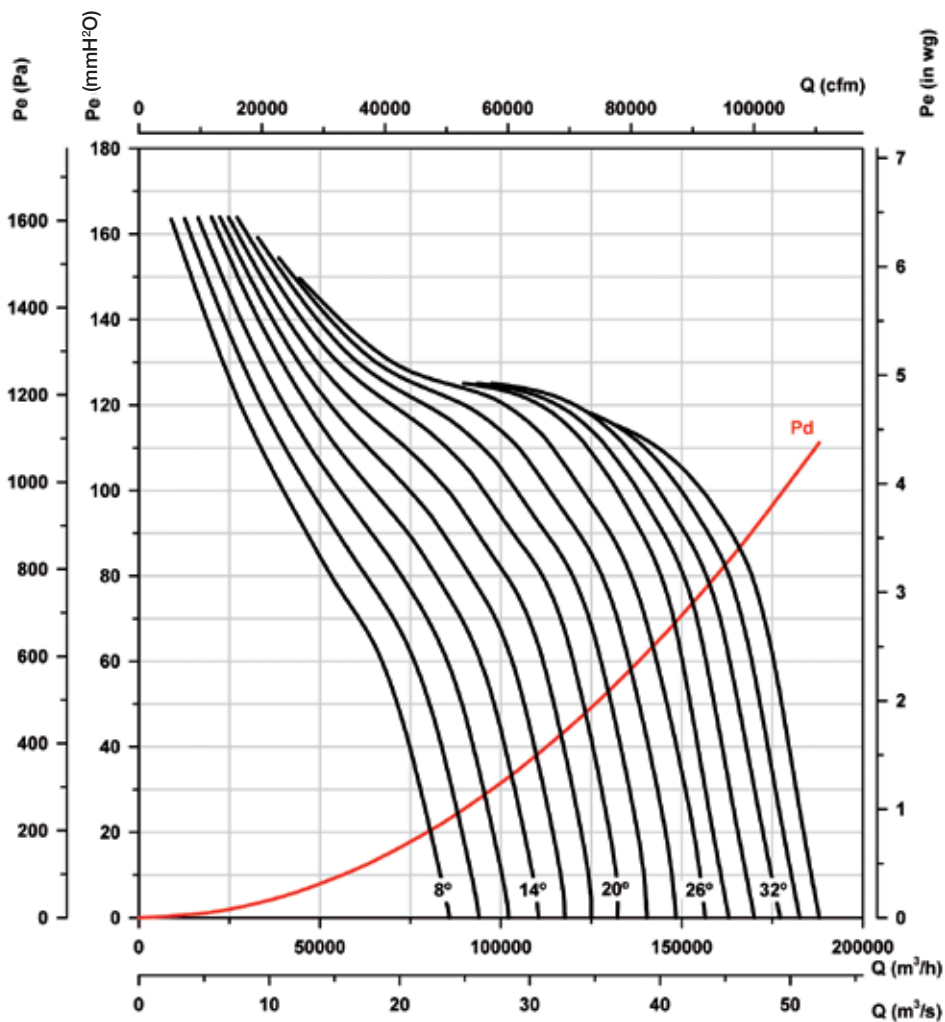

**Absorbed power**

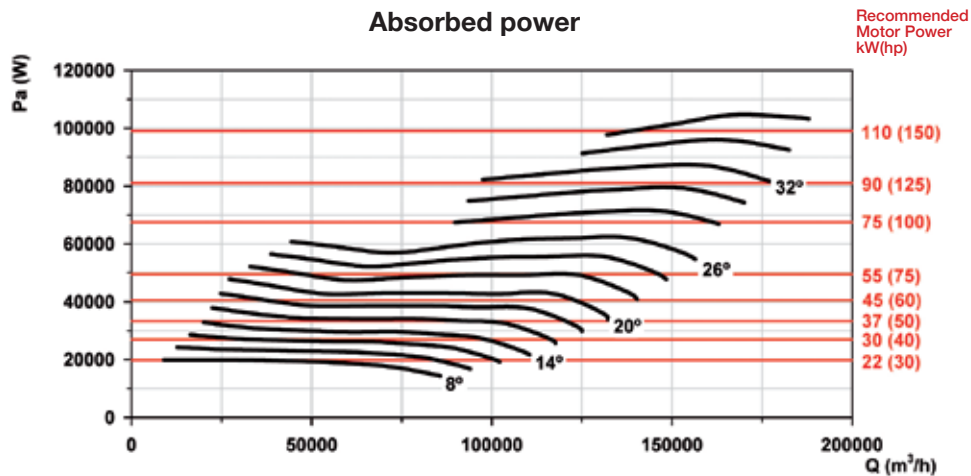

**Characteristic curves**

Q= Flow rate in m<sup>3</sup>/h, m<sup>3</sup>/s and cfm.

Pe= Static pressure in mmH<sub>2</sub>O, Pa and inwg.

**Rotor diameter (cm): 125**

**Number of poles: 4**

**Number of blades: 9**

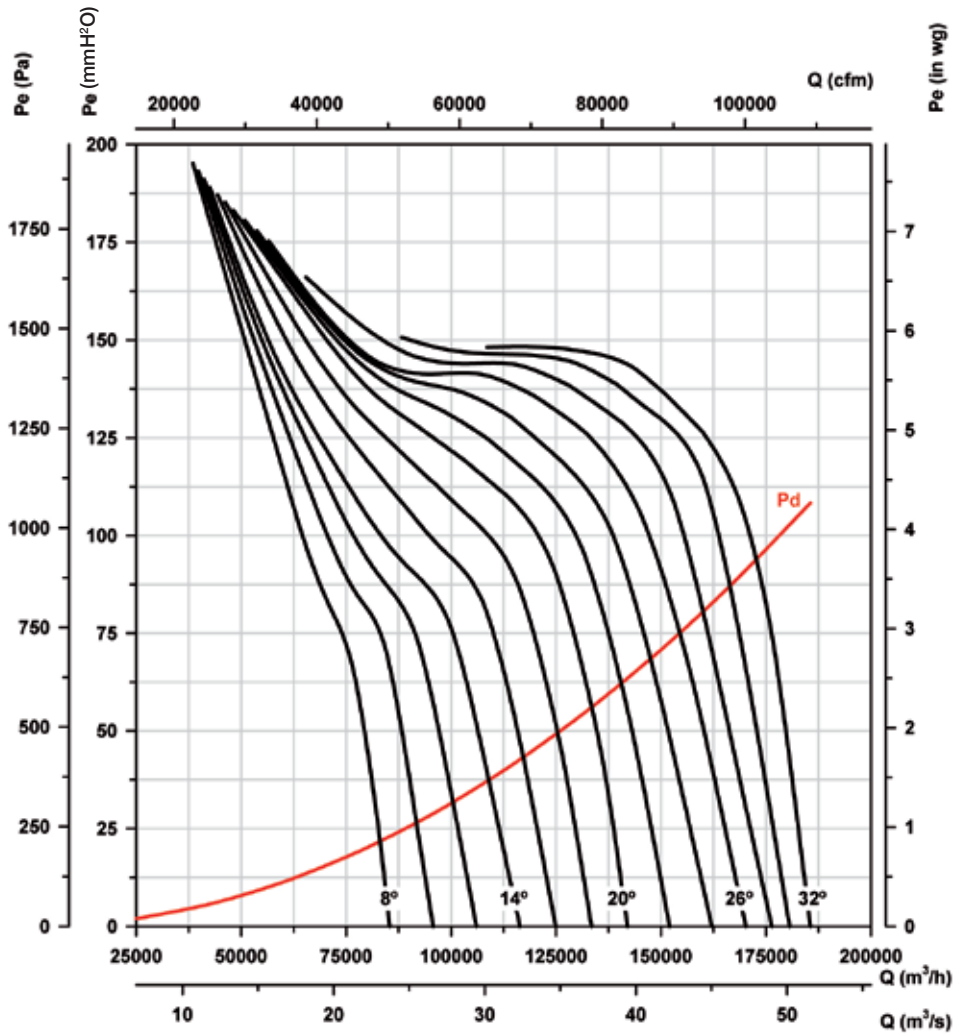

**Absorbed power**

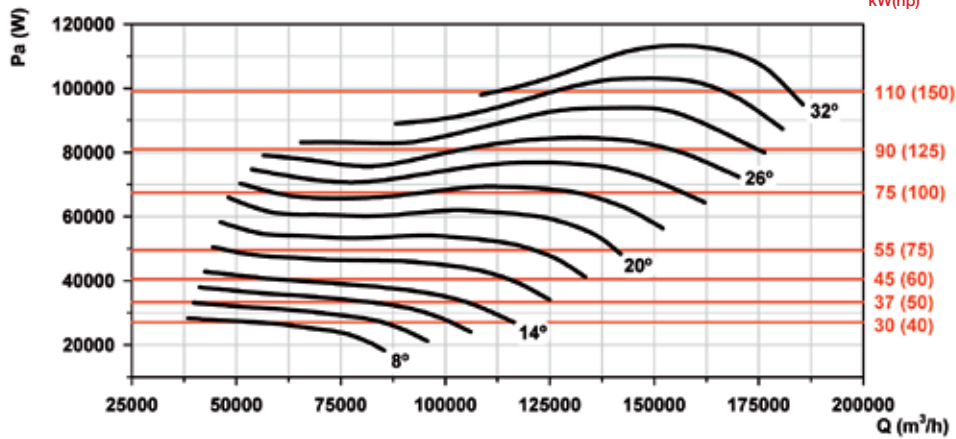

**Characteristic curves**

Q= Flow rate in m<sup>3</sup>/h, m<sup>3</sup>/s and cfm.

Pe= Static pressure in mmH<sup>2</sup>O, Pa and inwg.

**Rotor diameter (cm): 125**

**Number of poles: 6**

**Number of blades: 3**

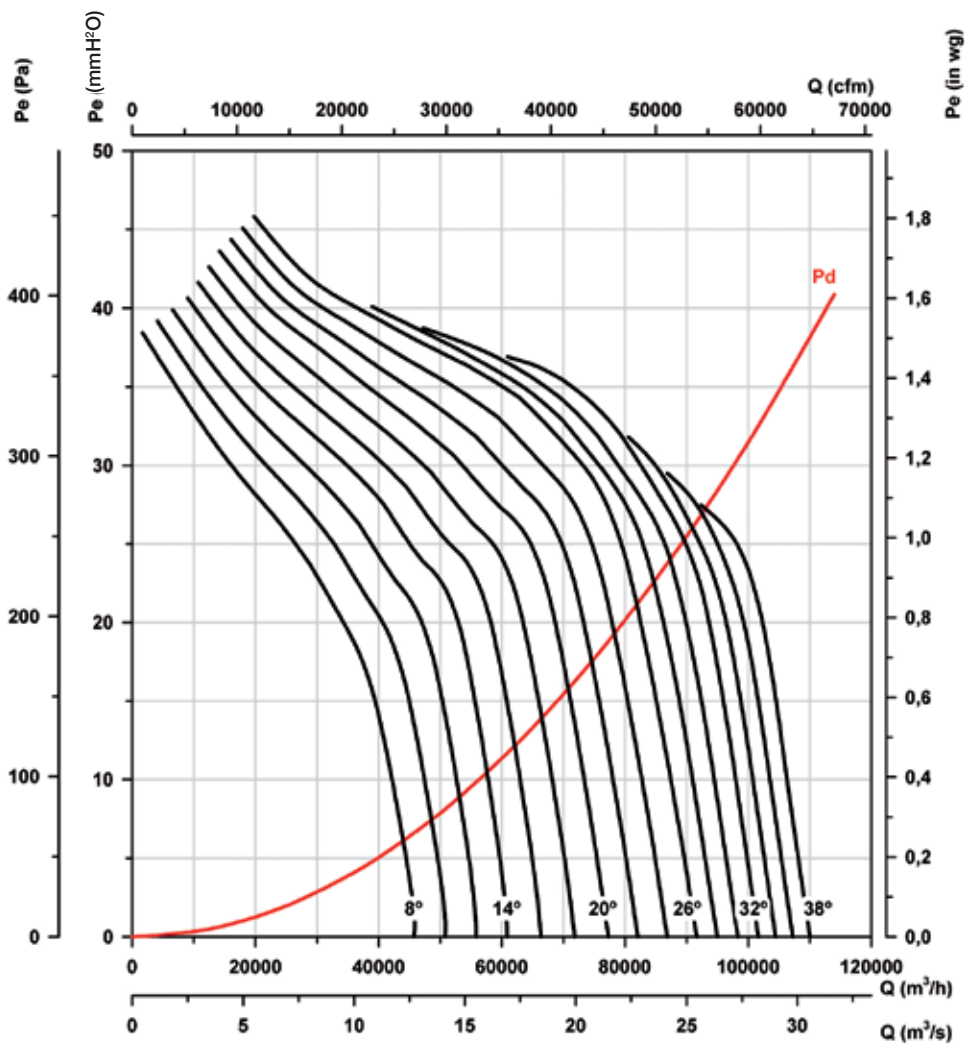

**Absorbed power**

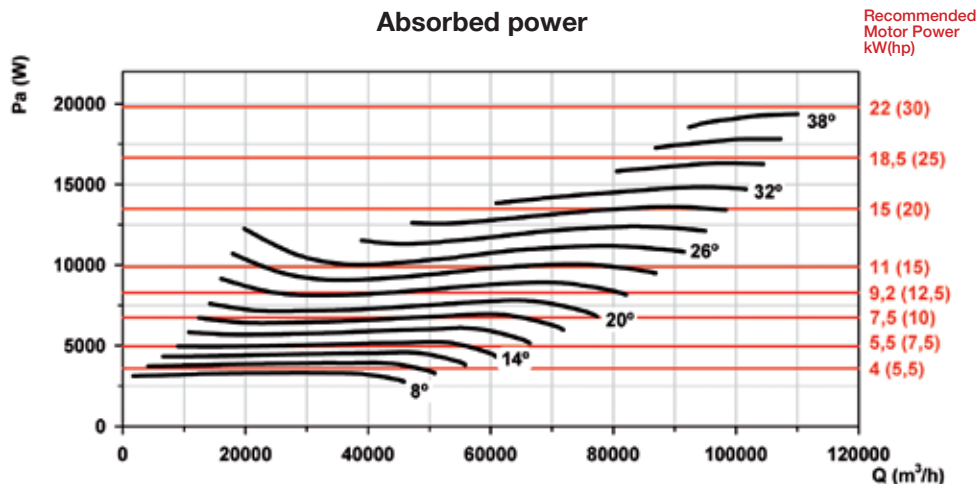

**Characteristic curves**

Q= Flow rate in m<sup>3</sup>/h, m<sup>3</sup>/s and cfm.

Pe= Static pressure in mmH<sub>2</sub>O, Pa and inwg.

**Rotor diameter (cm): 125**

**Number of poles: 6**

**Number of blades: 6**

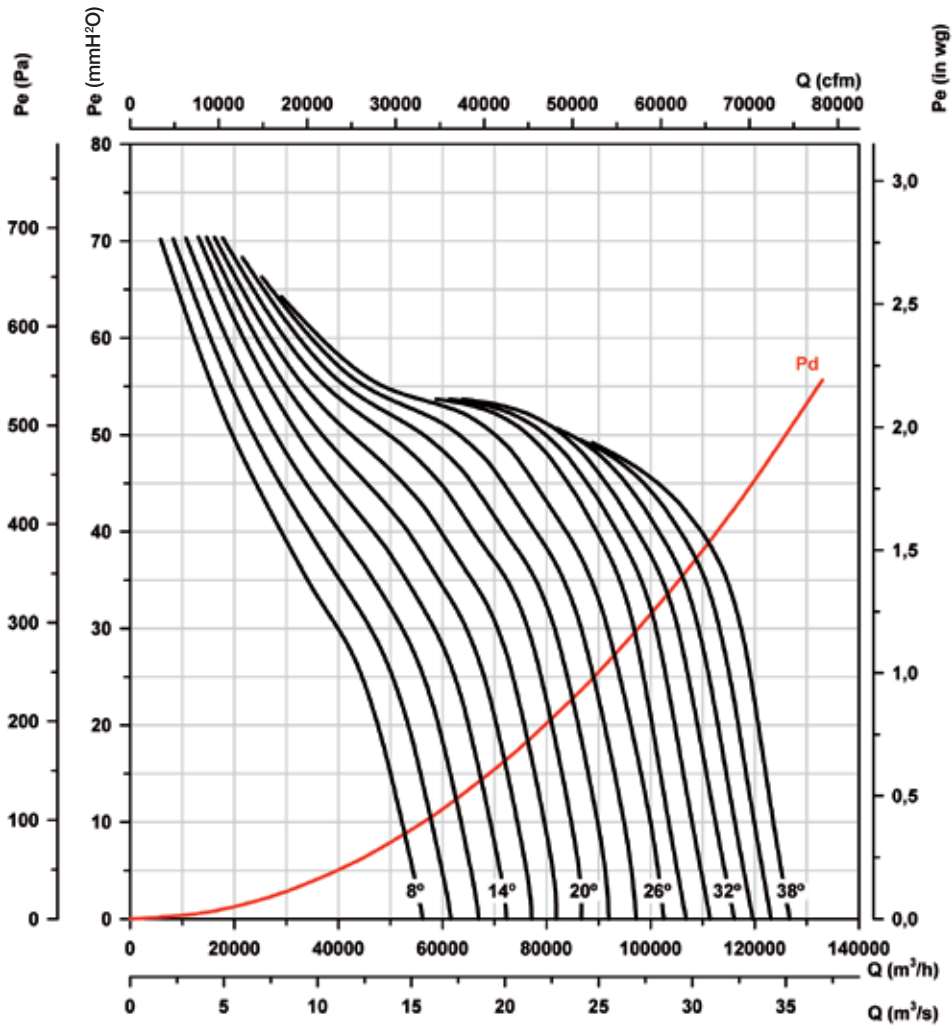

**Absorbed power**

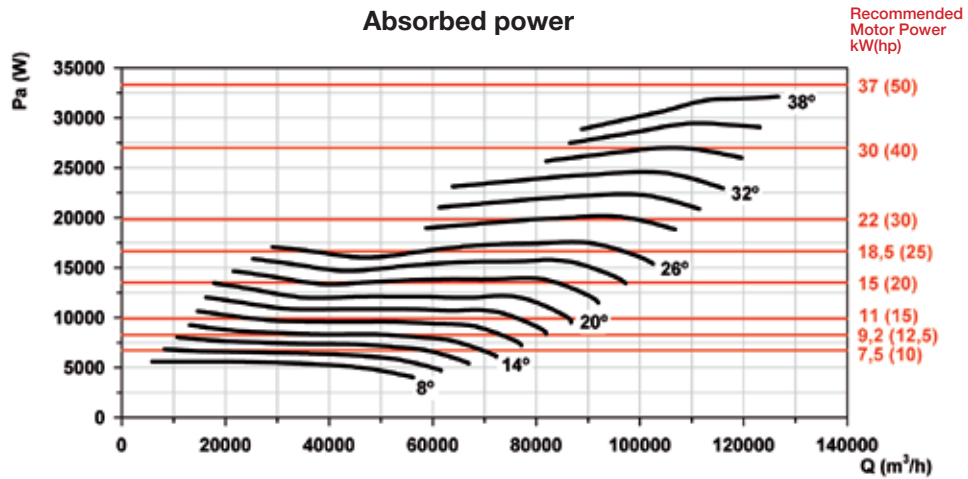

**Characteristic curves**

Q= Flow rate in m<sup>3</sup>/h, m<sup>3</sup>/s and cfm.

Pe= Static pressure in mmH<sup>2</sup>O, Pa and inwg.

**Rotor diameter (cm): 125**

**Number of poles: 6**

**Number of blades: 9**

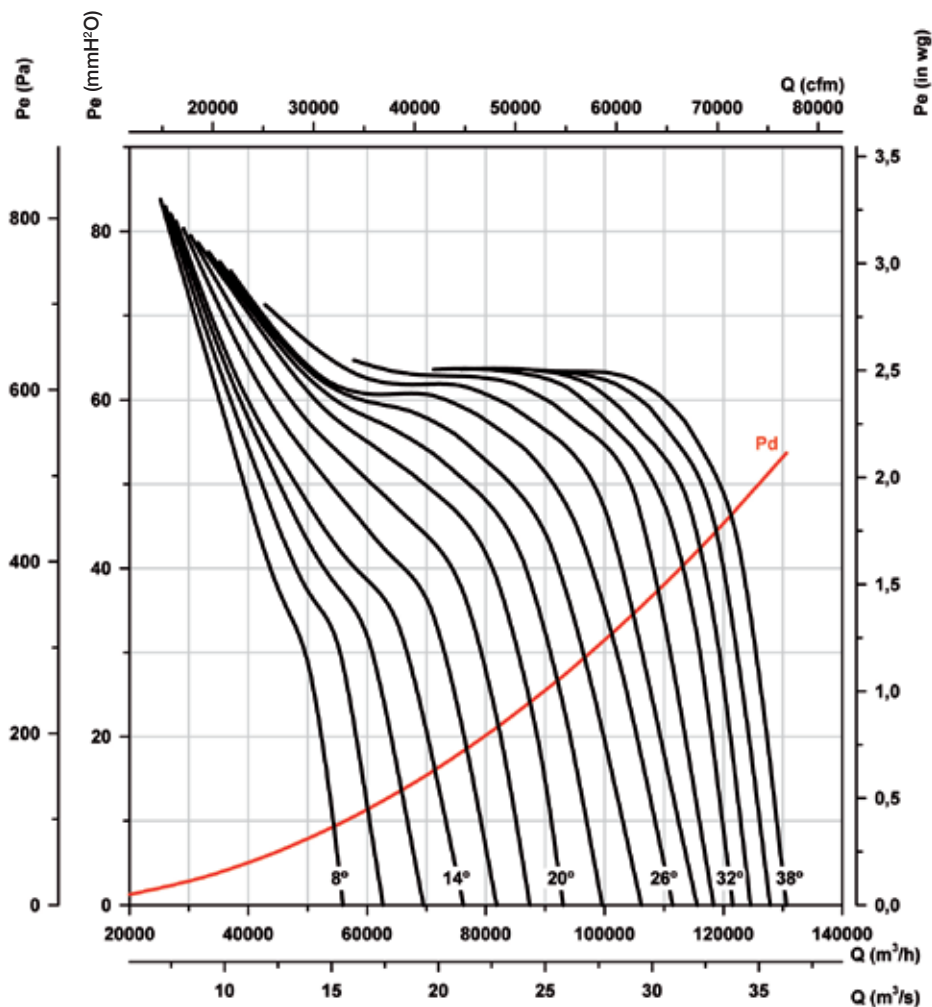

**Absorbed power**

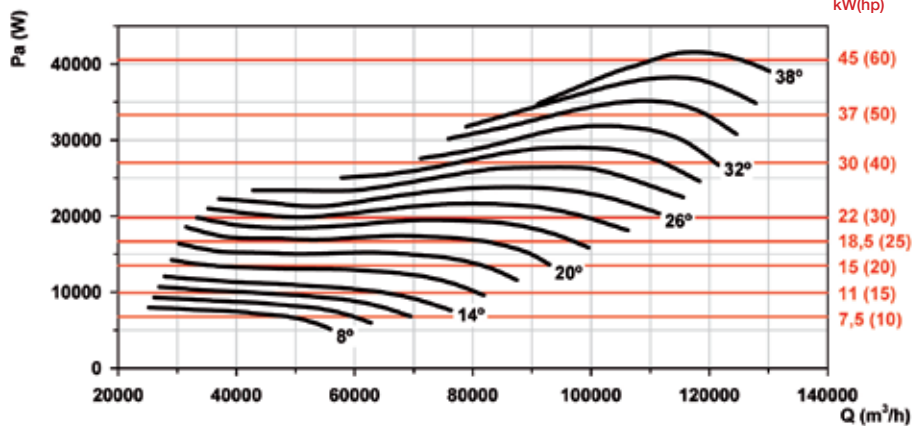

Recommended Motor Power kW(hp)

**Characteristic curves**

Q= Flow rate in m<sup>3</sup>/h, m<sup>3</sup>/s and cfm.

Pe= Static pressure in mmH<sub>2</sub>O, Pa and inwg.

**Rotor diameter (cm): 125**

**Number of poles: 8**

**Number of blades: 3**

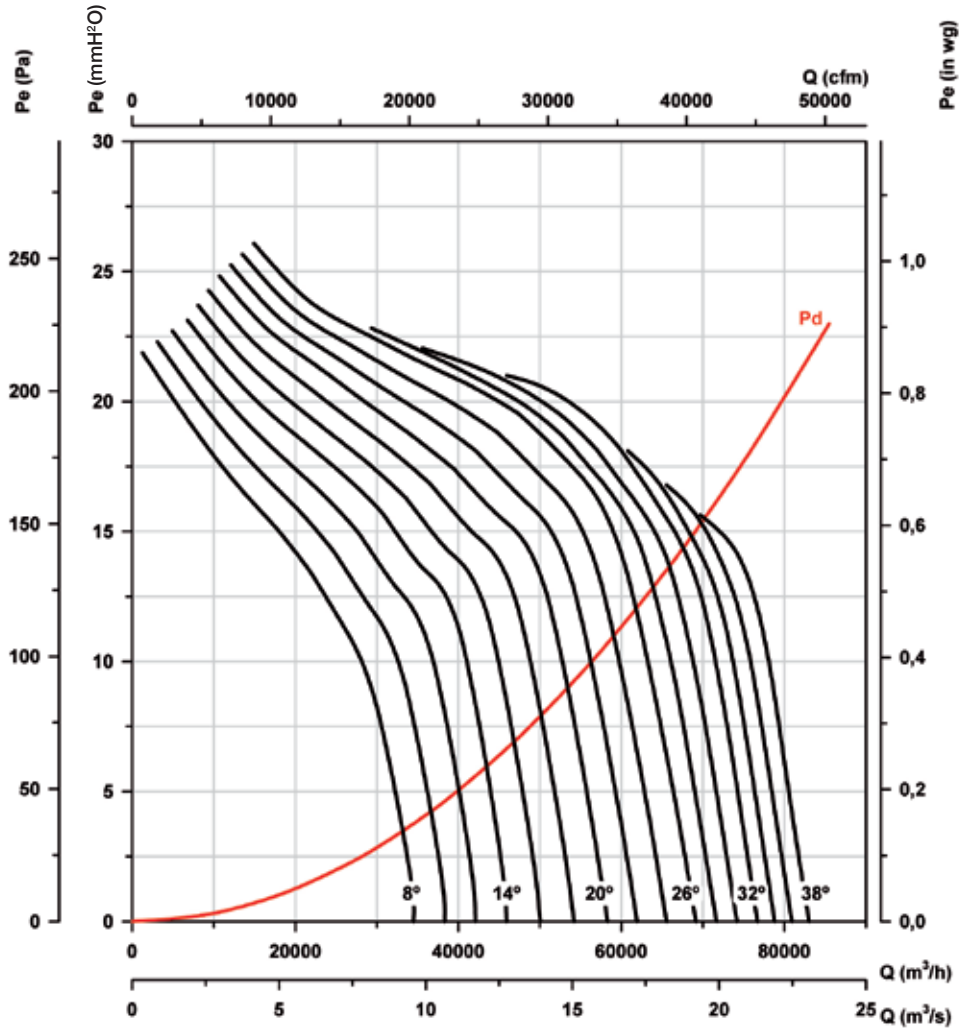

**Absorbed power**

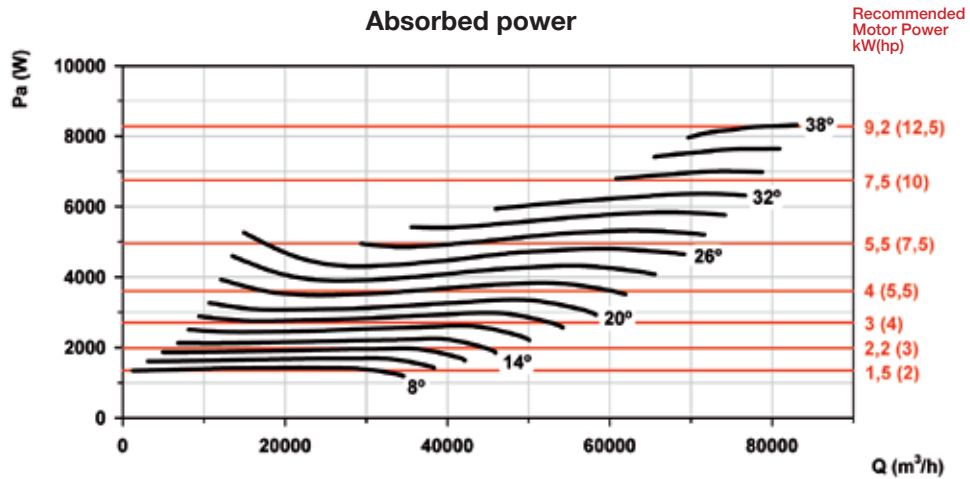

**Characteristic curves**

Q= Flow rate in m<sup>3</sup>/h, m<sup>3</sup>/s and cfm.

Pe= Static pressure in mmH<sub>2</sub>O, Pa and inwg.

**Rotor diameter (cm): 125**

**Number of poles: 8**

**Number of blades: 6**

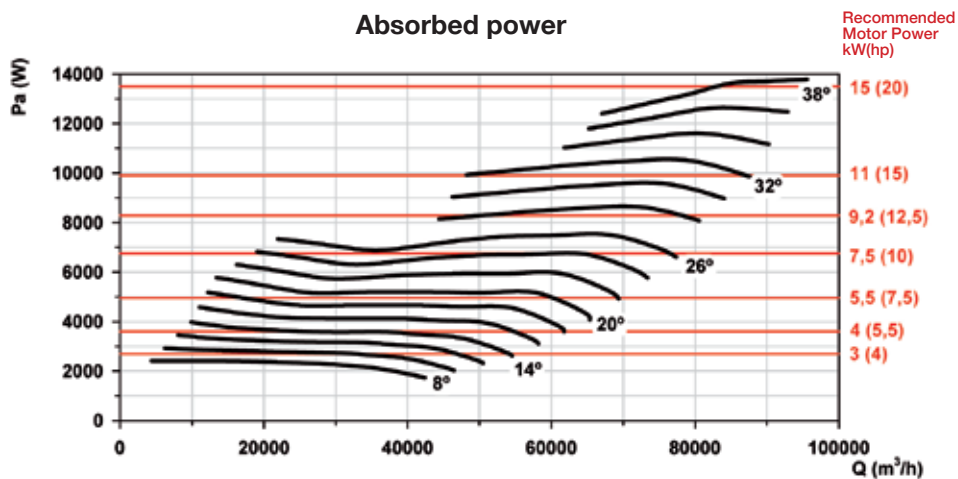
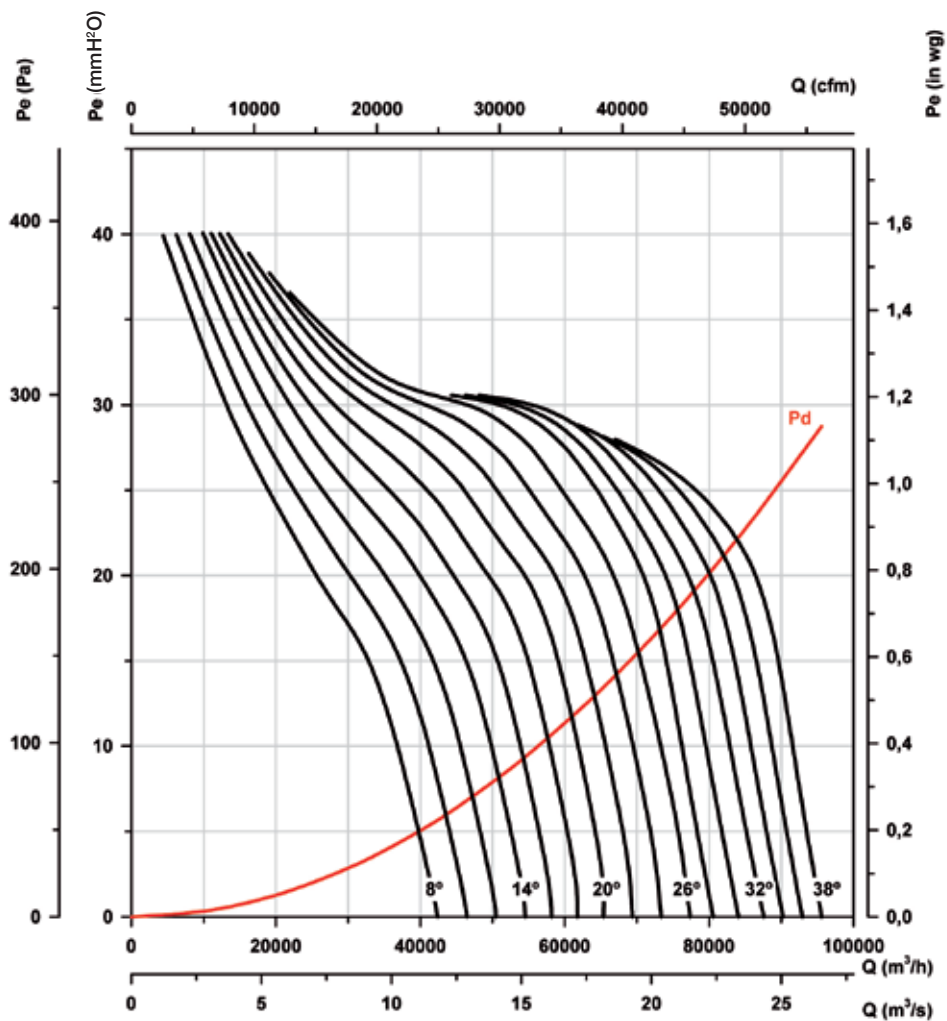



**Characteristic curves**

Q= Flow rate in m<sup>3</sup>/h, m<sup>3</sup>/s and cfm.

Pe= Static pressure in mmH<sub>2</sub>O, Pa and inwg.

**Rotor diameter (cm): 125**

**Number of poles: 8**

**Number of blades: 9**

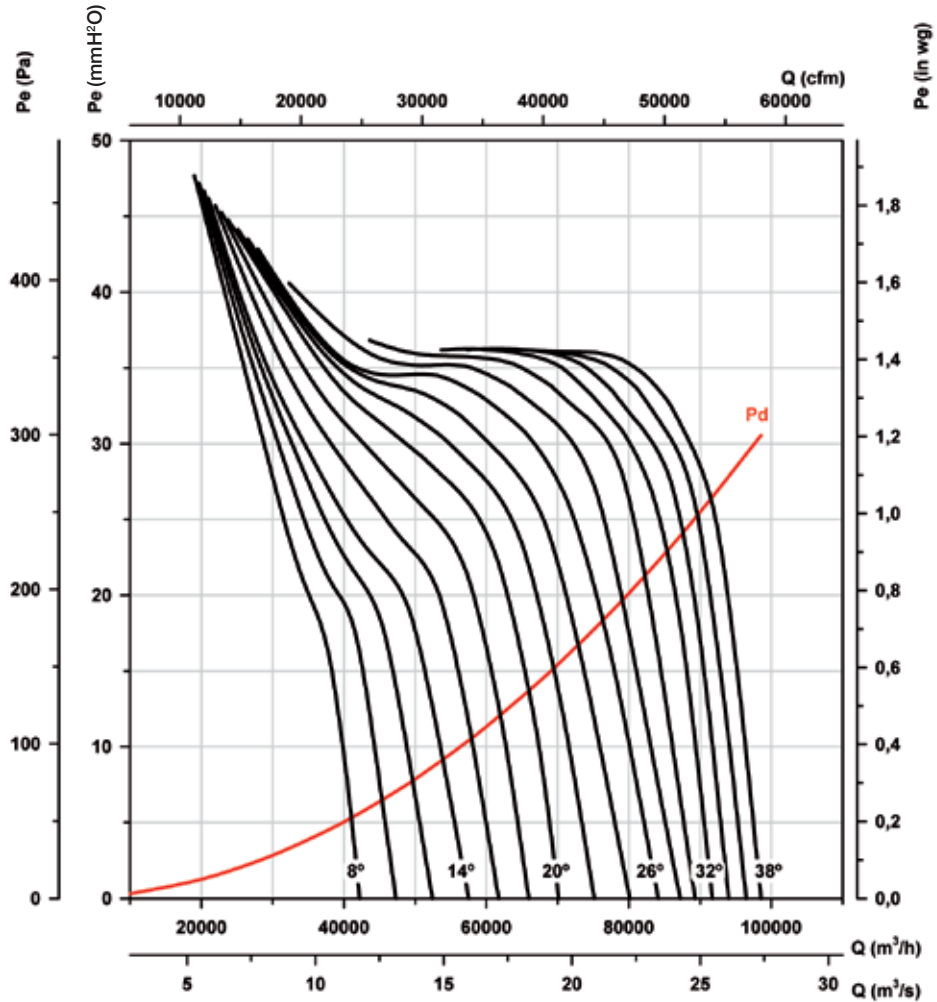

**Absorbed power**

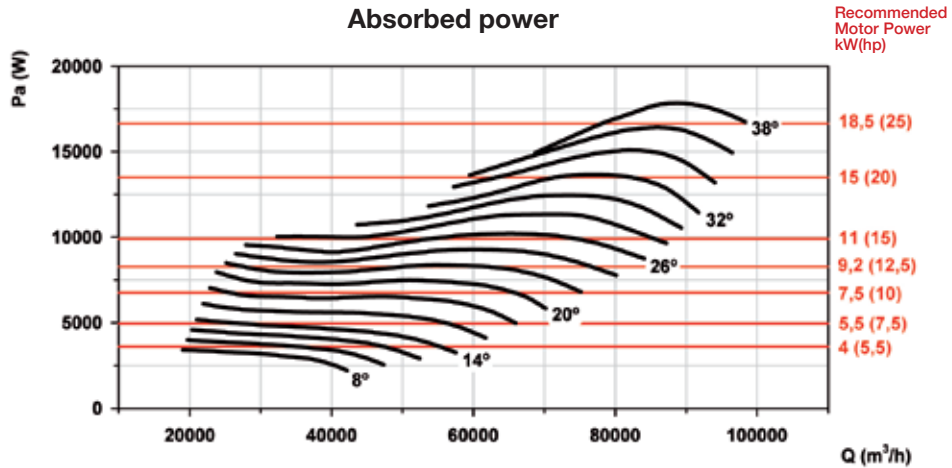

**Characteristic curves**

Q= Flow rate in m<sup>3</sup>/h, m<sup>3</sup>/s and cfm.

Pe= Static pressure in mmH<sub>2</sub>O, Pa and inwg.

**Rotor diameter (cm): 140**

**Number of poles: 6**

**Number of blades: 3**

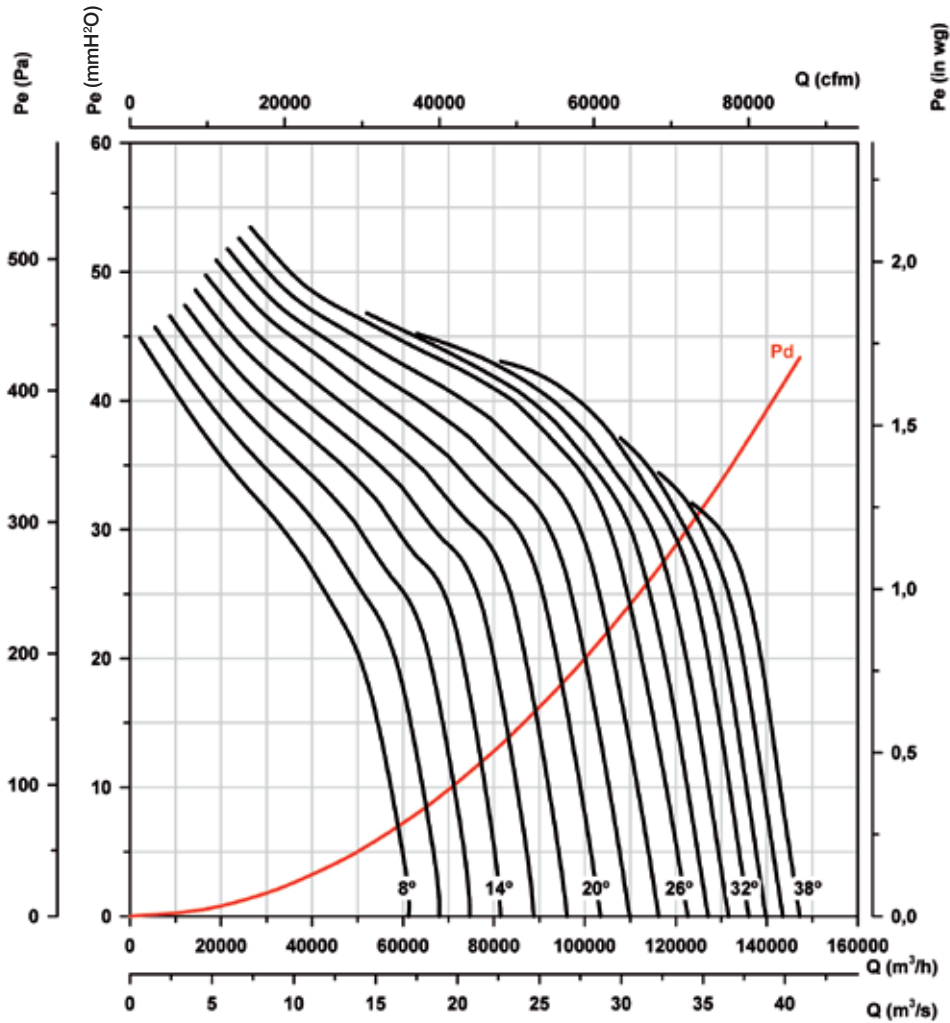

**Absorbed power**

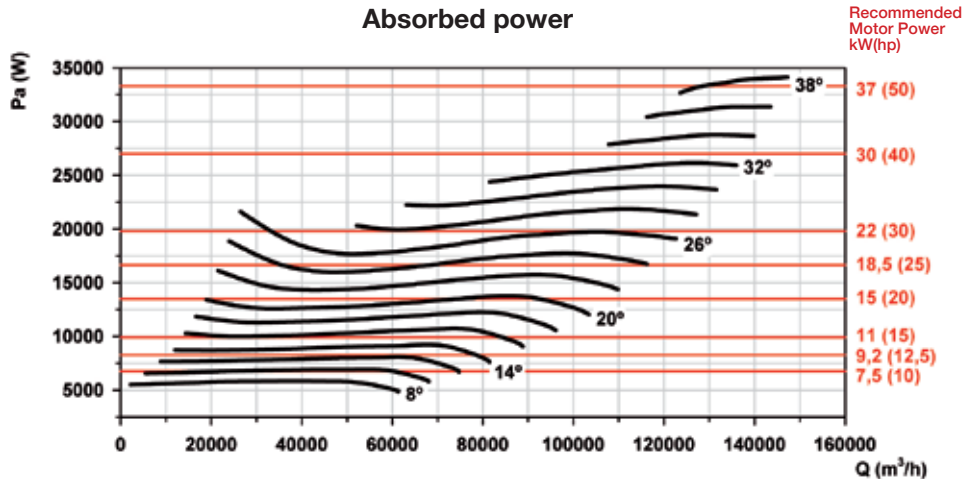

**Characteristic curves**

Q= Flow rate in m<sup>3</sup>/h, m<sup>3</sup>/s and cfm.

Pe= Static pressure in mmH<sub>2</sub>O, Pa and inwg.

**Rotor diameter (cm): 140**

**Number of poles: 6**

**Number of blades: 6**

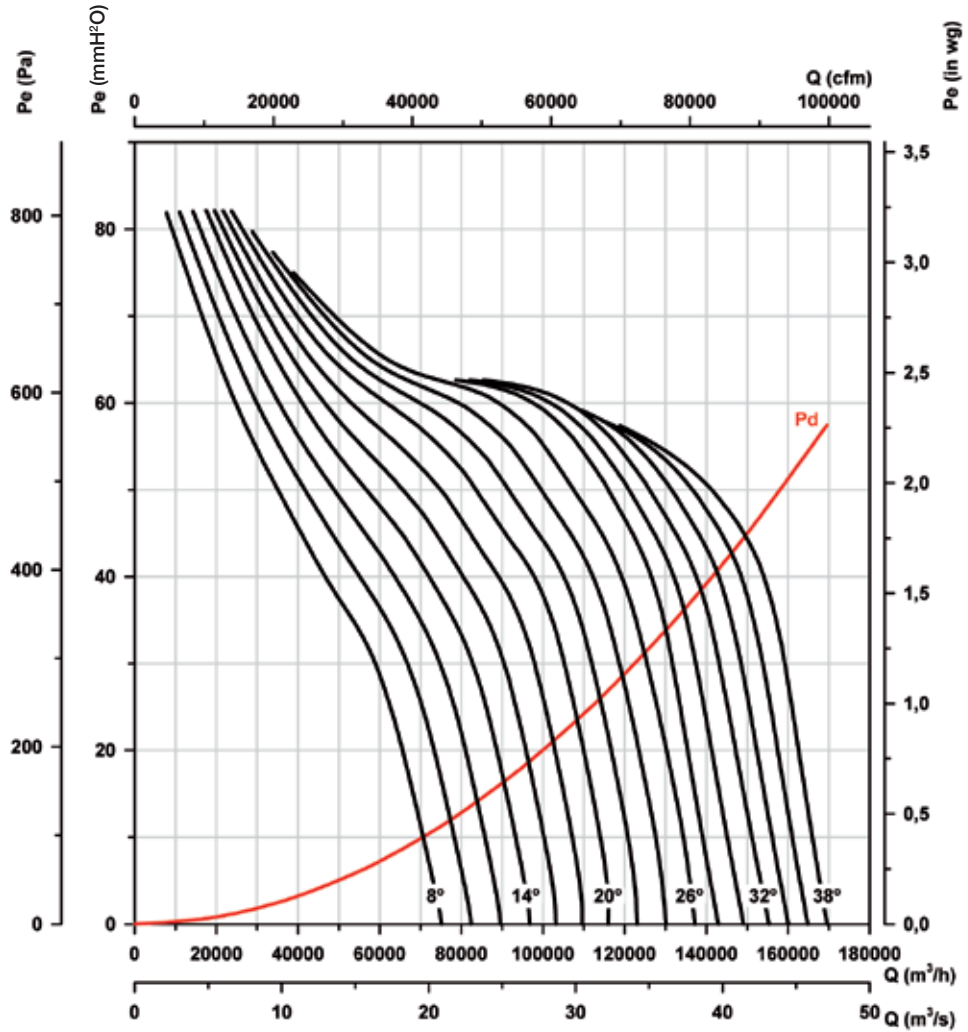

**Absorbed power**

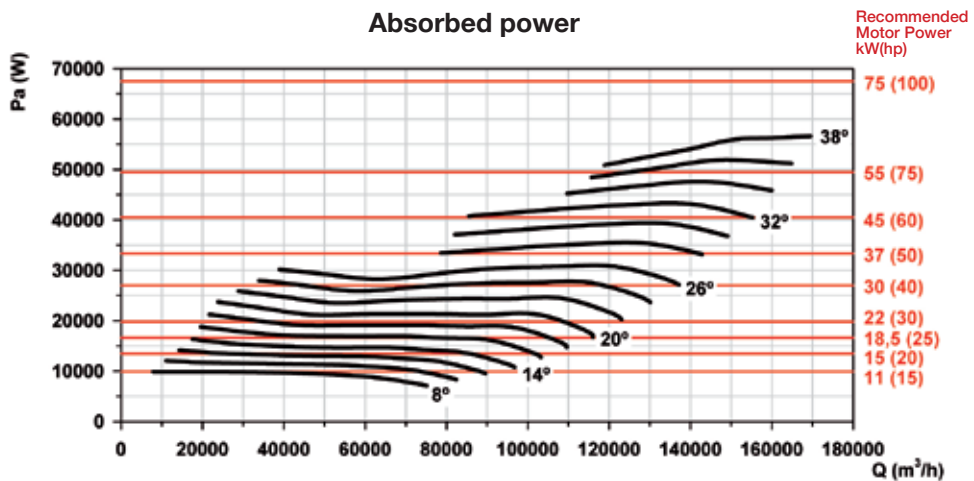

**Characteristic curves**

Q= Flow rate in m<sup>3</sup>/h, m<sup>3</sup>/s and cfm.

Pe= Static pressure in mmH<sub>2</sub>O, Pa and inwg.

**Rotor diameter (cm): 140**

**Number of poles: 6**

**Number of blades: 9**

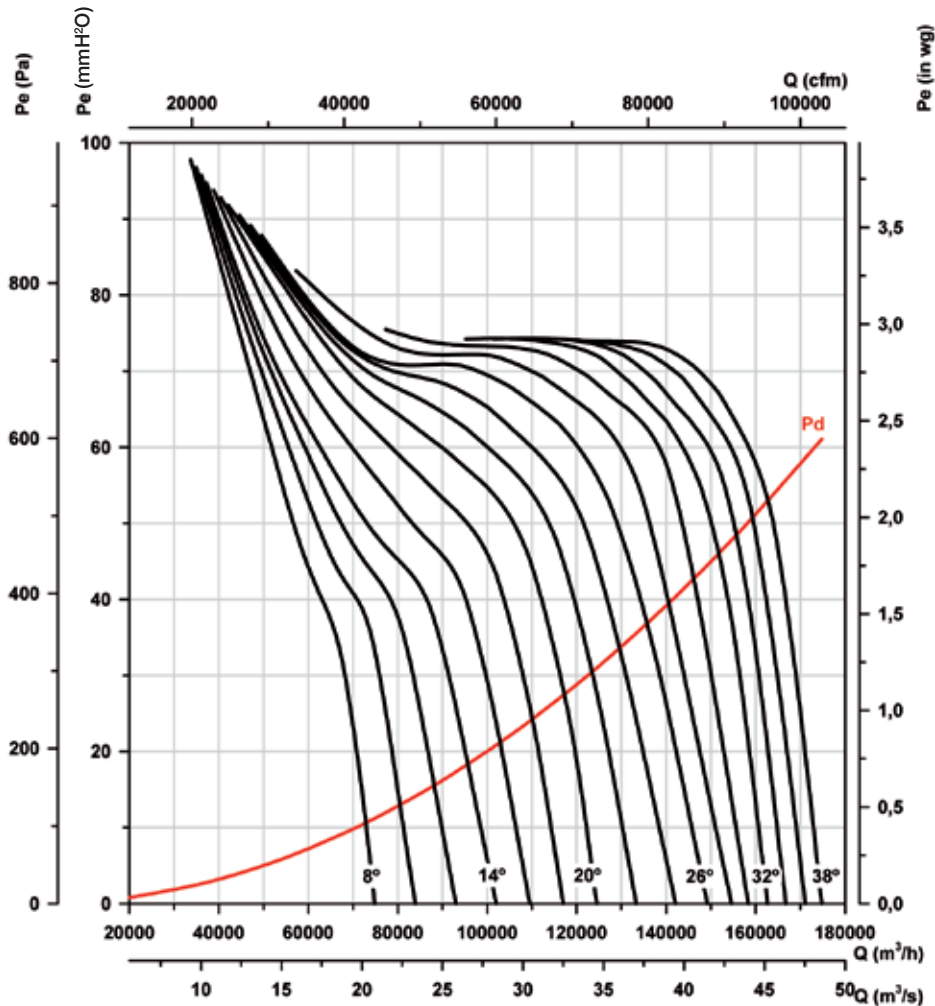

**Absorbed power**

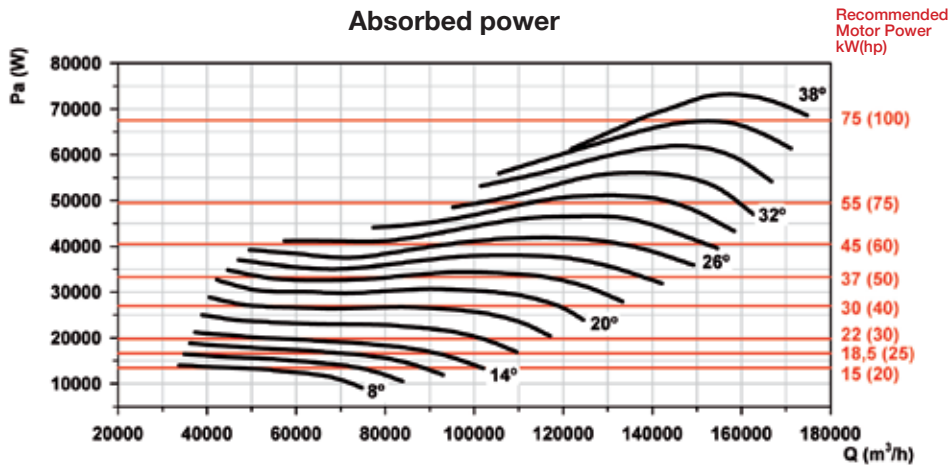

**Characteristic curves**

Q= Flow rate in m<sup>3</sup>/h, m<sup>3</sup>/s and cfm.

Pe= Static pressure in mmH<sub>2</sub>O, Pa and inwg.

**Rotor diameter (cm): 140**

**Number of poles: 8**

**Number of blades: 3**

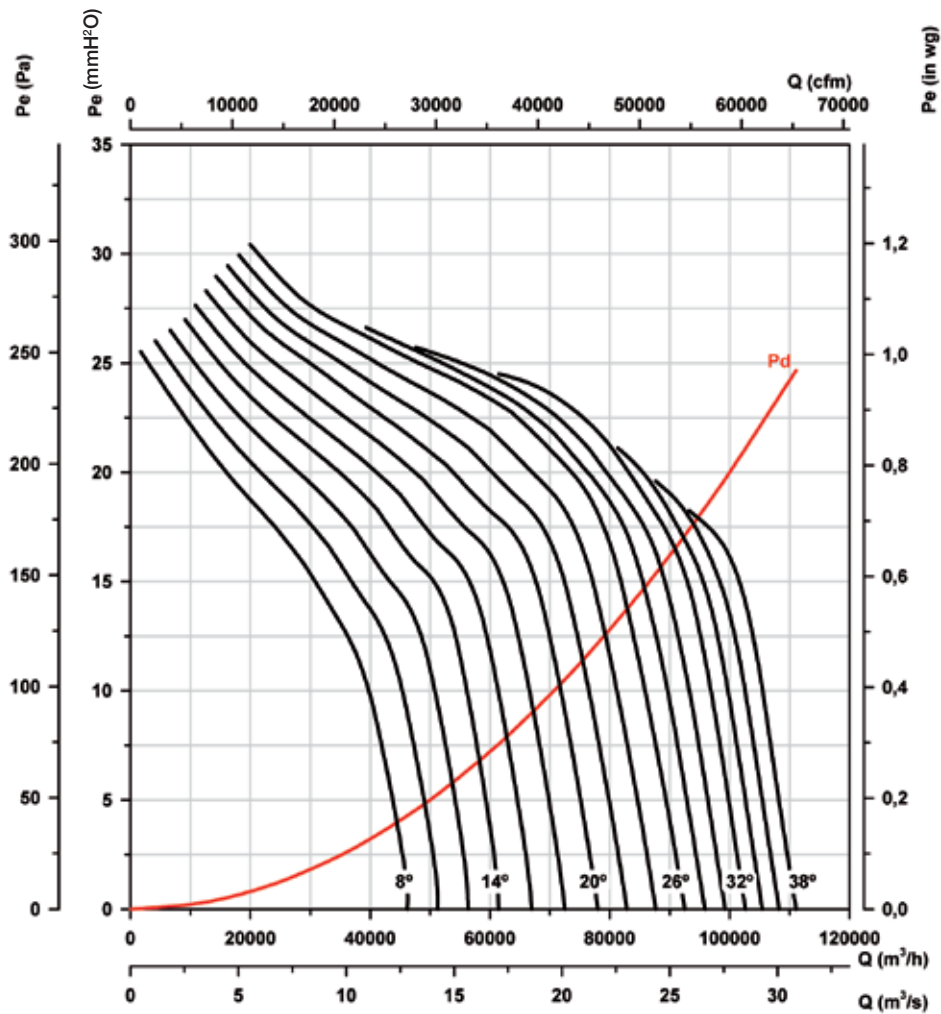

**Absorbed power**

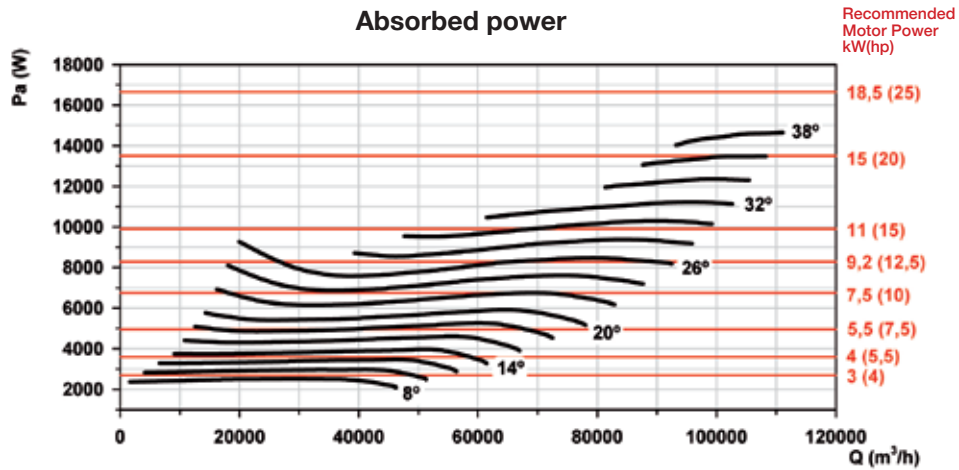

Characteristic curves

Q= Flow rate in m<sup>3</sup>/h, m<sup>3</sup>/s and cfm.

Pe= Static pressure in mmH<sub>2</sub>O, Pa and inwg.

Rotor diameter (cm): 140

Number of poles: 8

Number of blades: 6

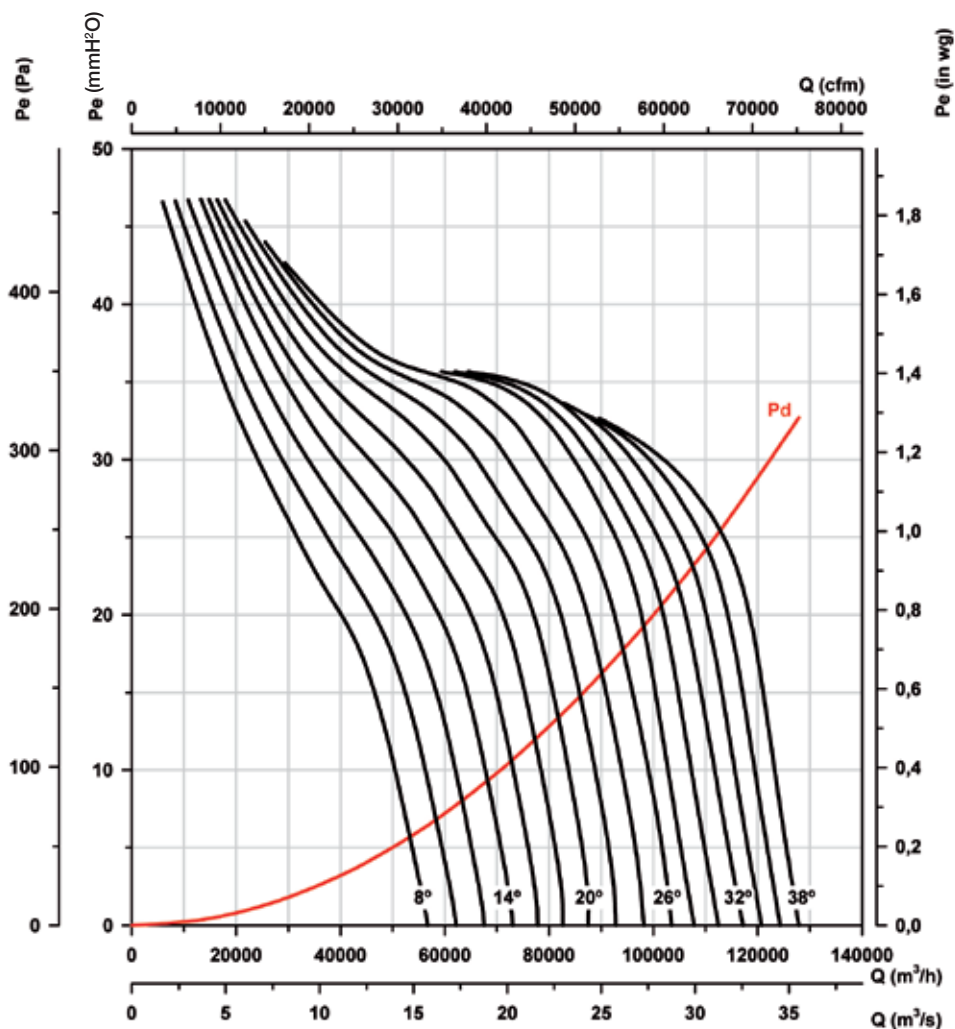

Absorbed power

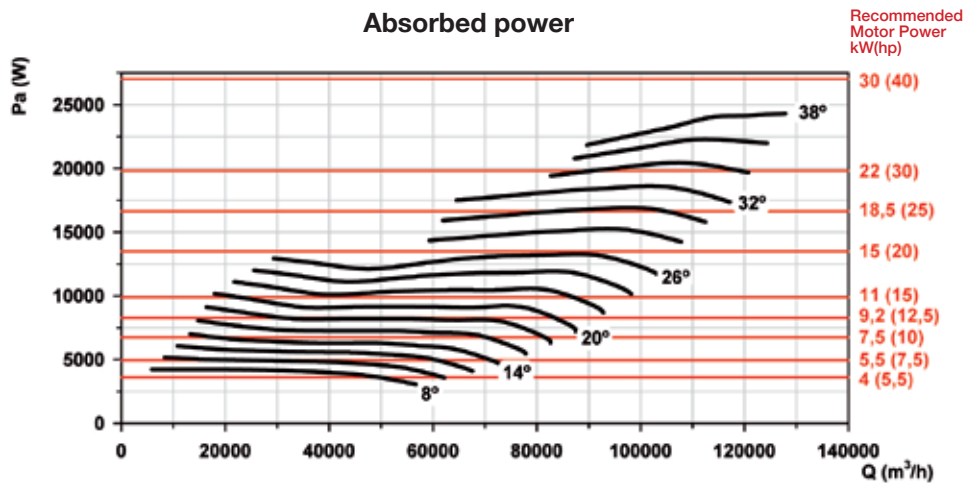

**Characteristic curves**

Q= Flow rate in m<sup>3</sup>/h, m<sup>3</sup>/s and cfm.

Pe= Static pressure in mmH<sub>2</sub>O, Pa and inwg.

**Rotor diameter (cm): 140**

**Number of poles: 8**

**Number of blades: 9**

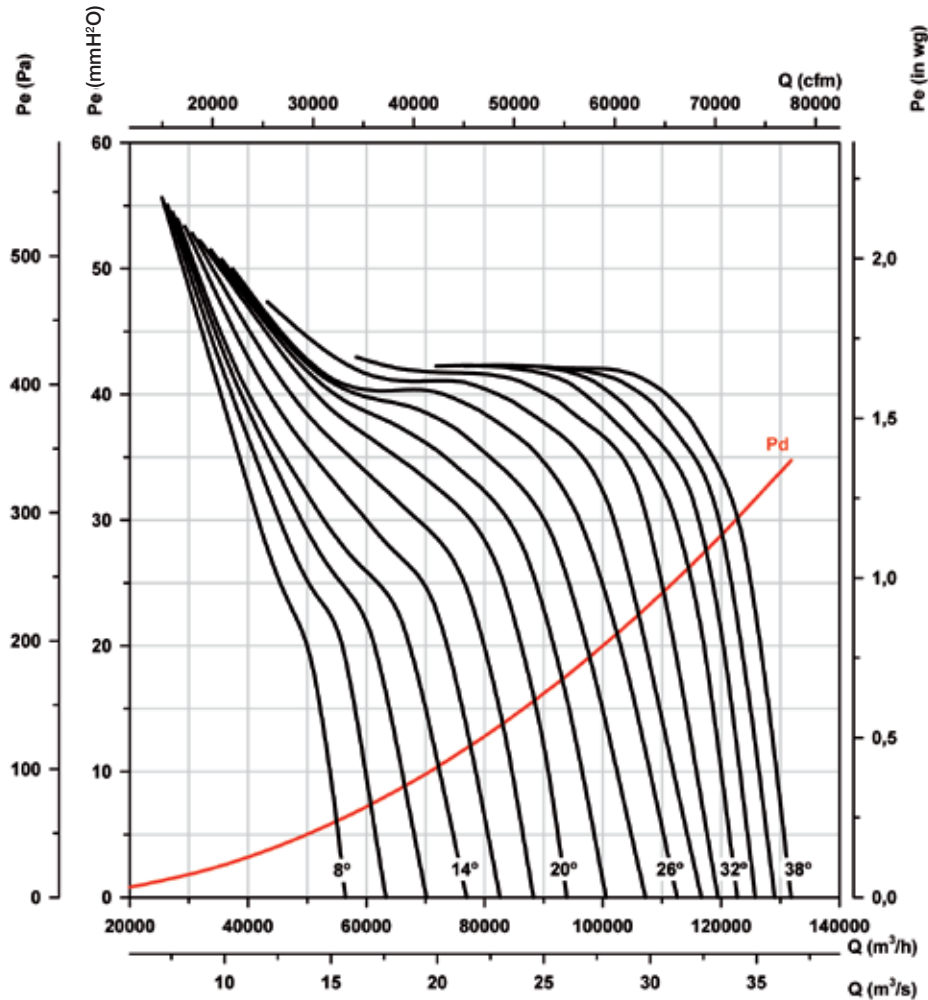

Absorbed power

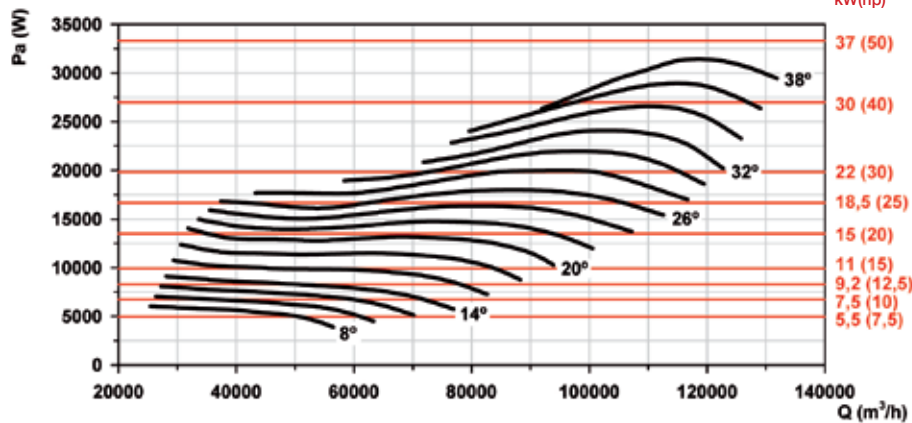

**Characteristic curves**

Q= Flow rate in m<sup>3</sup>/h, m<sup>3</sup>/s and cfm.

Pe= Static pressure in mmH<sub>2</sub>O, Pa and inwg.

**Rotor diameter (cm): 160**

**Number of poles: 6**

**Number of blades: 3**

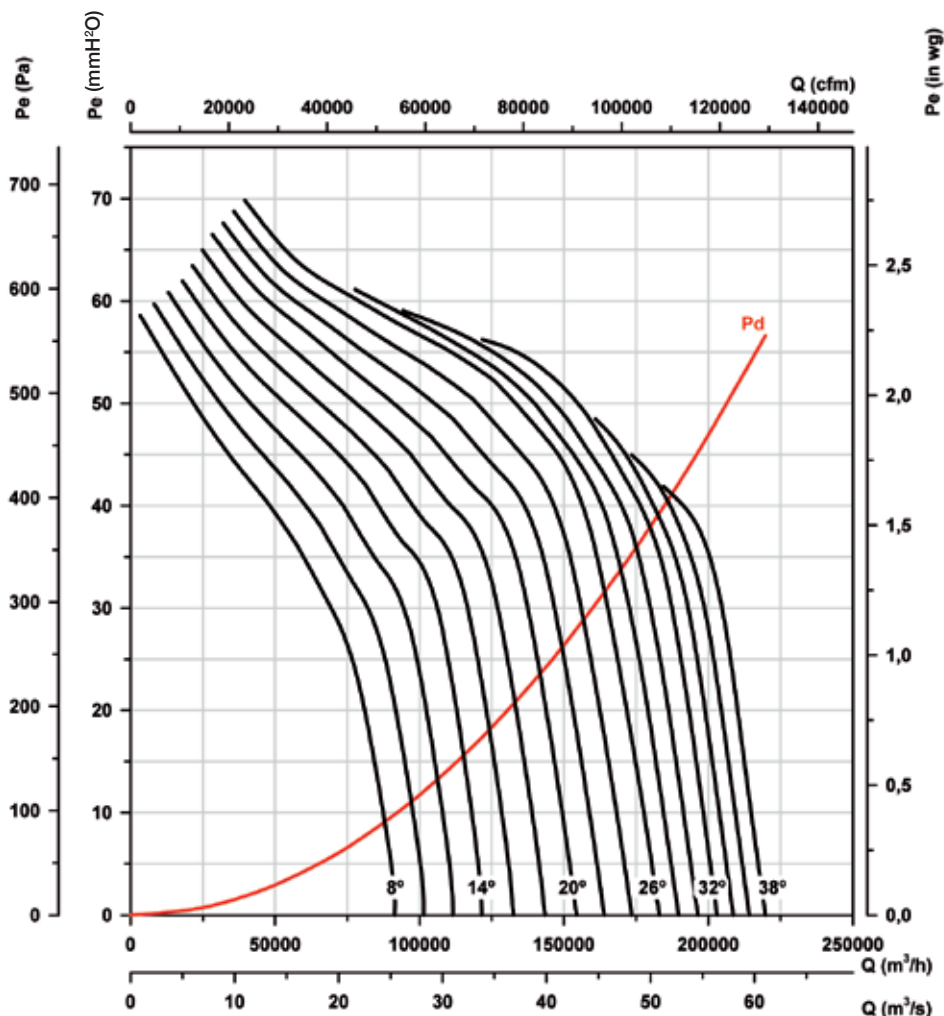

**Absorbed power**

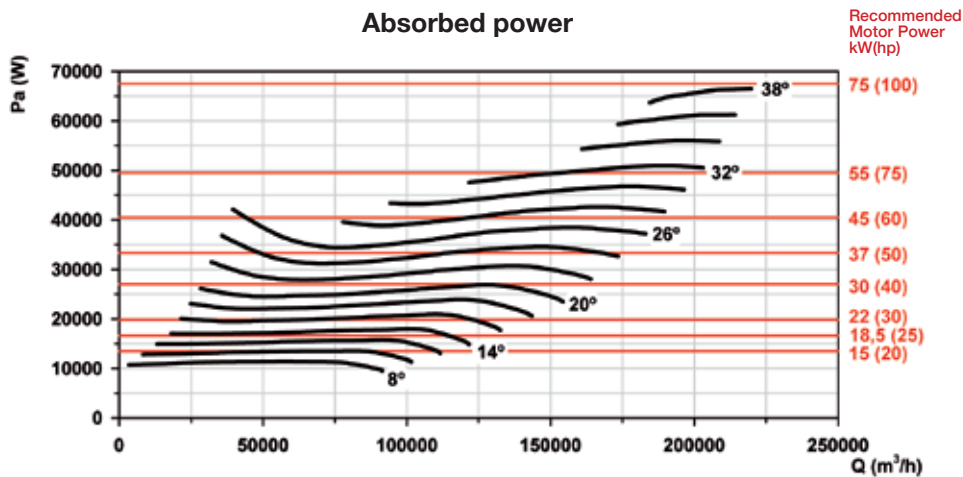



**Characteristic curves**

Q= Flow rate in m<sup>3</sup>/h, m<sup>3</sup>/s and cfm.

Pe= Static pressure in mmH<sub>2</sub>O, Pa and inwg.

**Rotor diameter (cm): 160**

**Number of poles: 6**

**Number of blades: 6**

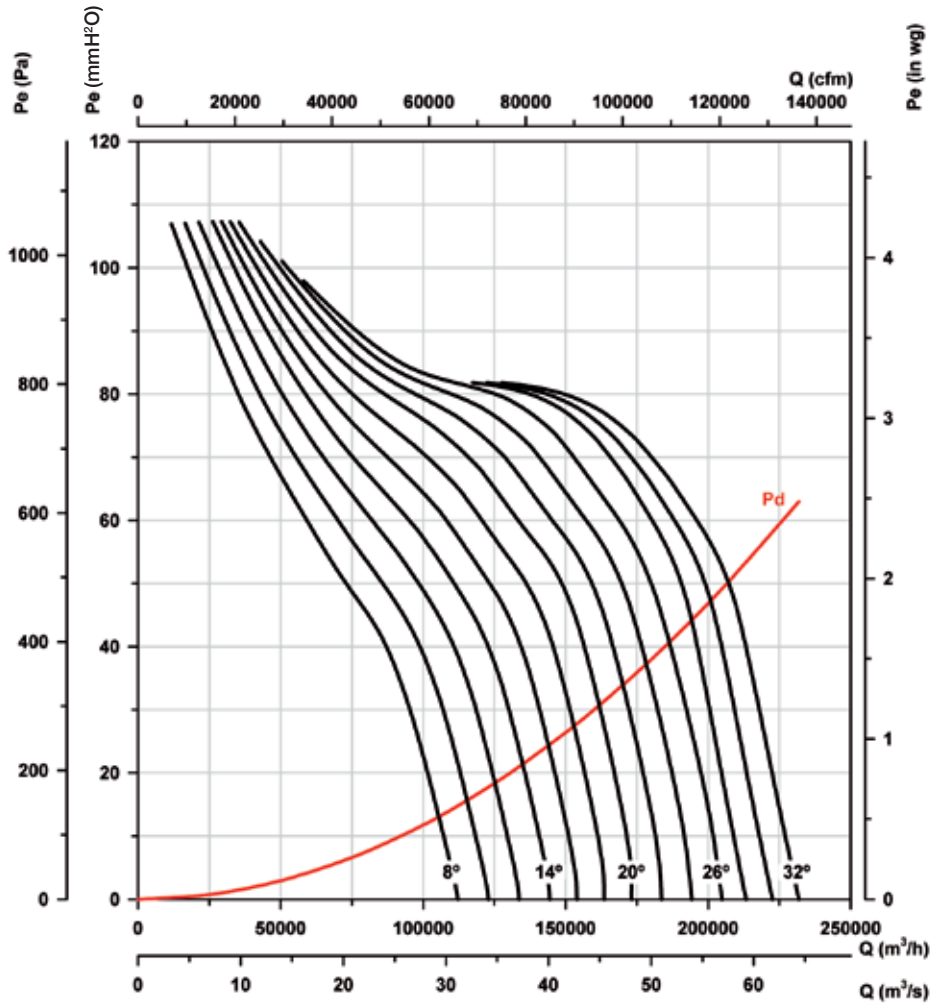

**Absorbed power**

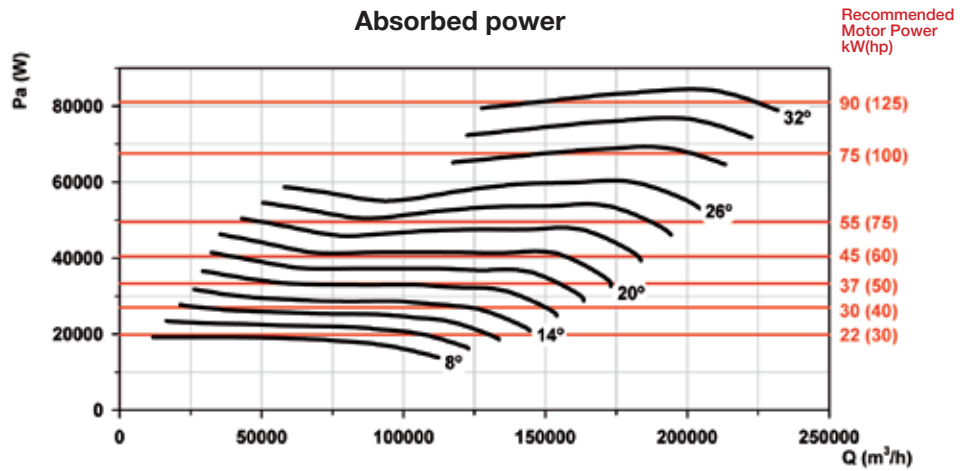

Characteristic curves

Q= Flow rate in m<sup>3</sup>/h, m<sup>3</sup>/s and cfm.

Pe= Static pressure in mmH<sub>2</sub>O, Pa and inwg.

Rotor diameter (cm): 160

Number of poles: 6

Number of blades: 9

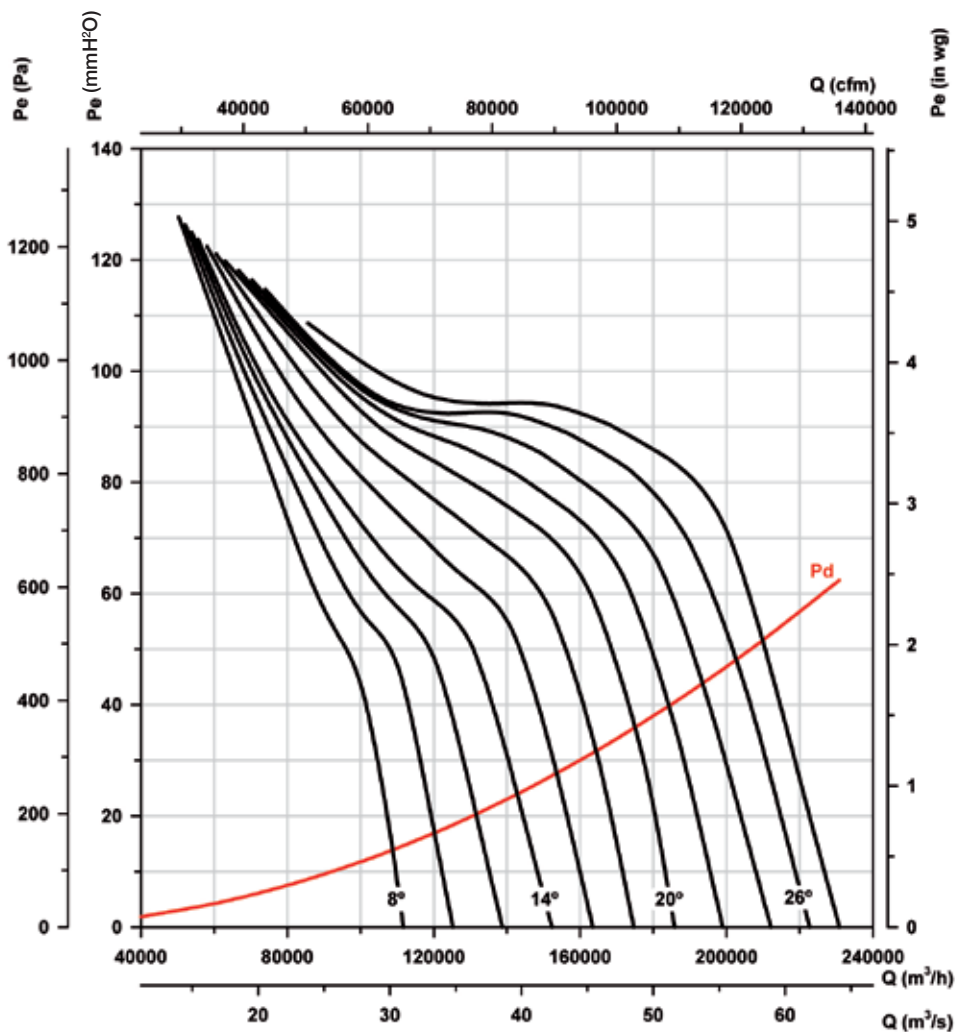

Absorbed power

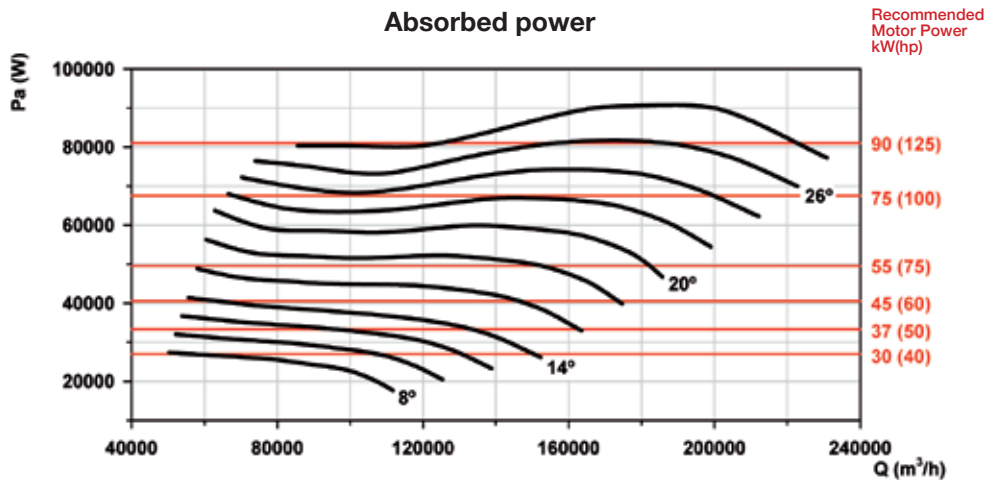

**Characteristic curves**

Q= Flow rate in m<sup>3</sup>/h, m<sup>3</sup>/s and cfm.

Pe= Static pressure in mmH<sup>2</sup>O, Pa and inwg.

**Rotor diameter (cm): 160**

**Number of poles: 8**

**Number of blades: 3**

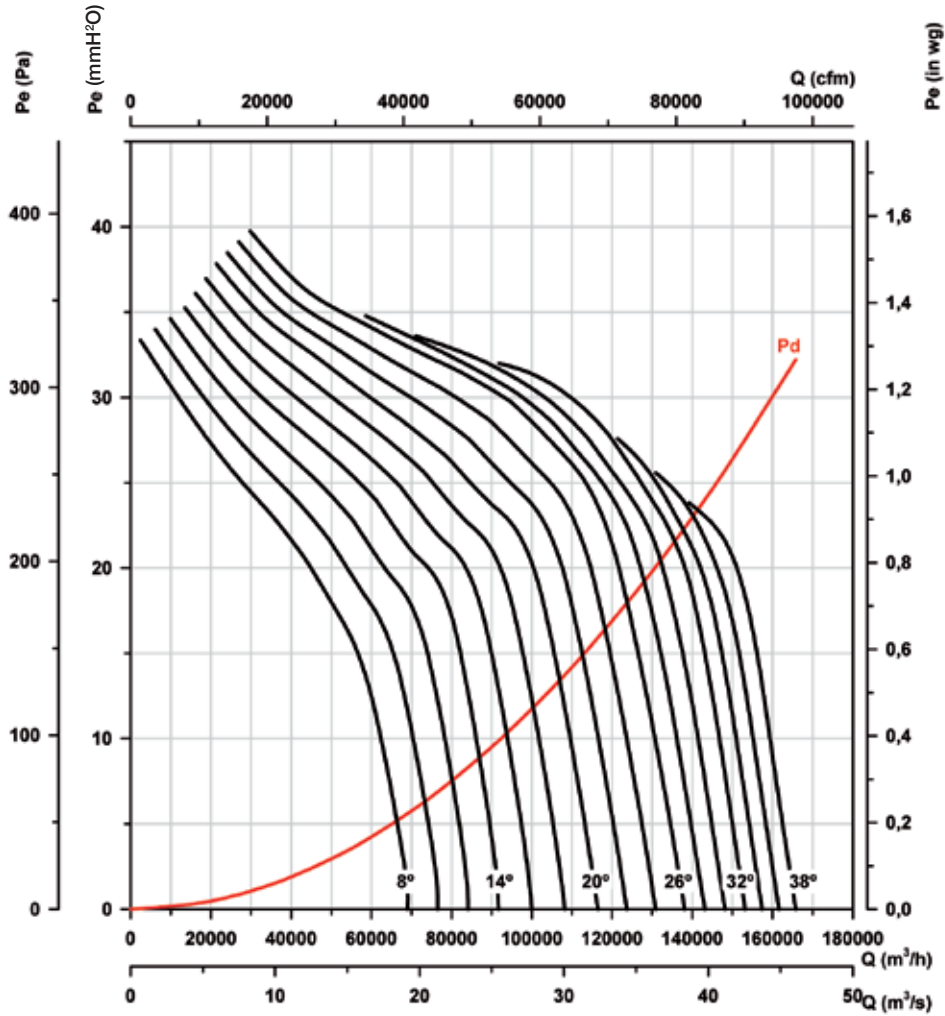

**Absorbed power**

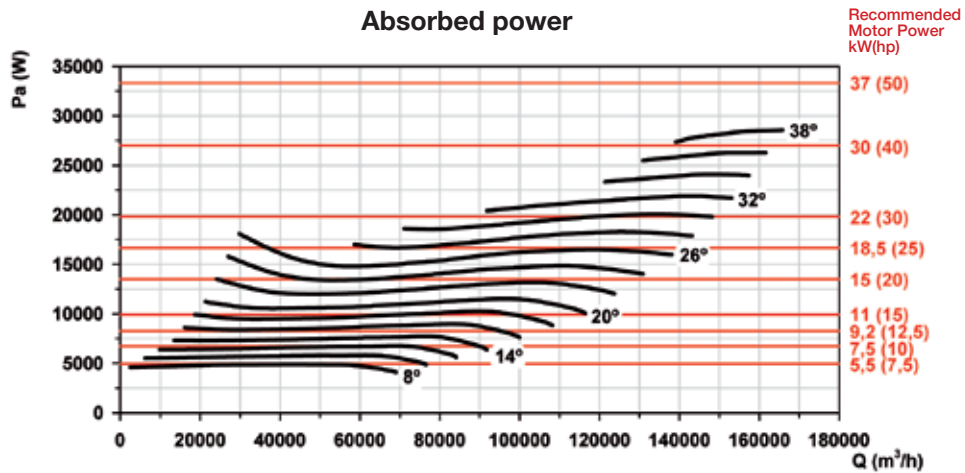

**Characteristic curves**

Q= Flow rate in m<sup>3</sup>/h, m<sup>3</sup>/s and cfm.

Pe= Static pressure in mmH<sub>2</sub>O, Pa and inwg.

**Rotor diameter (cm): 160**

**Number of poles: 8**

**Number of blades: 6**

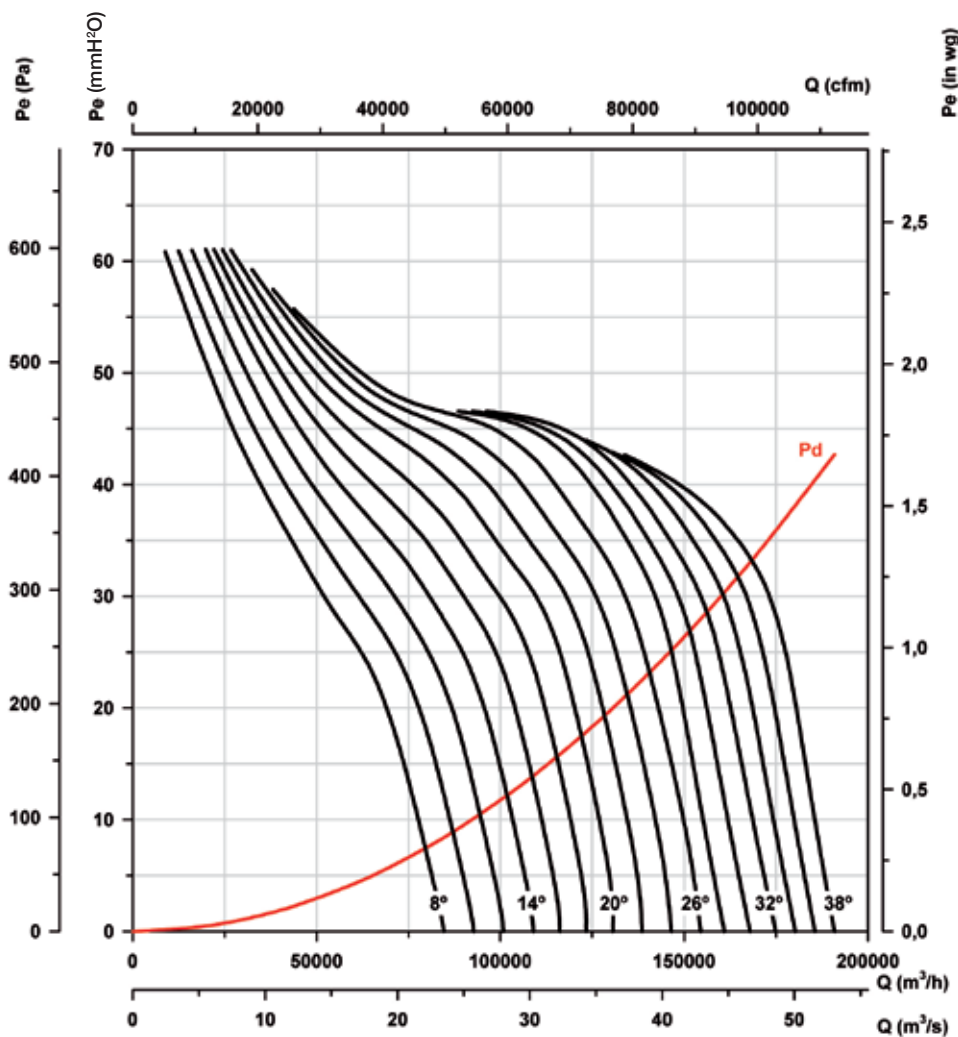

**Absorbed power**

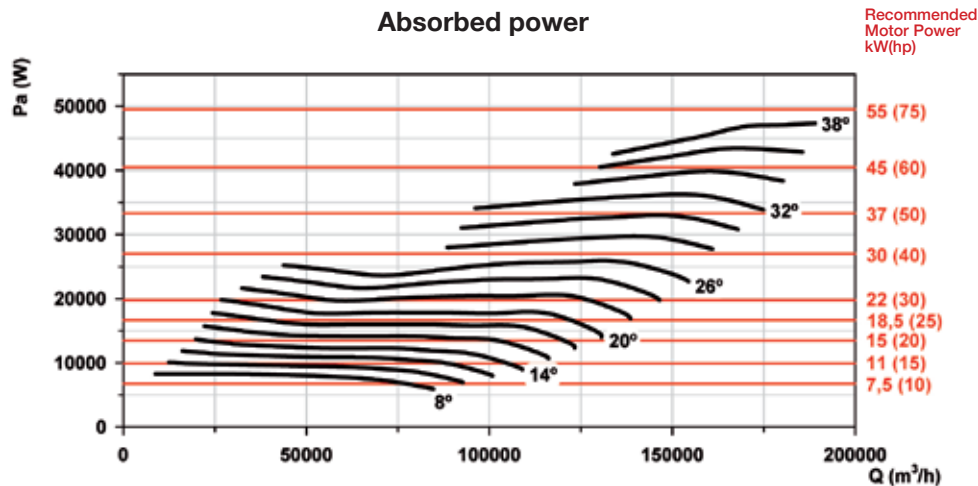

**Characteristic curves**

Q= Flow rate in m<sup>3</sup>/h, m<sup>3</sup>/s and cfm.

Pe= Static pressure in mmH<sub>2</sub>O, Pa and inwg.

**Rotor diameter (cm): 160**

**Number of poles: 8**

**Number of blades: 9**

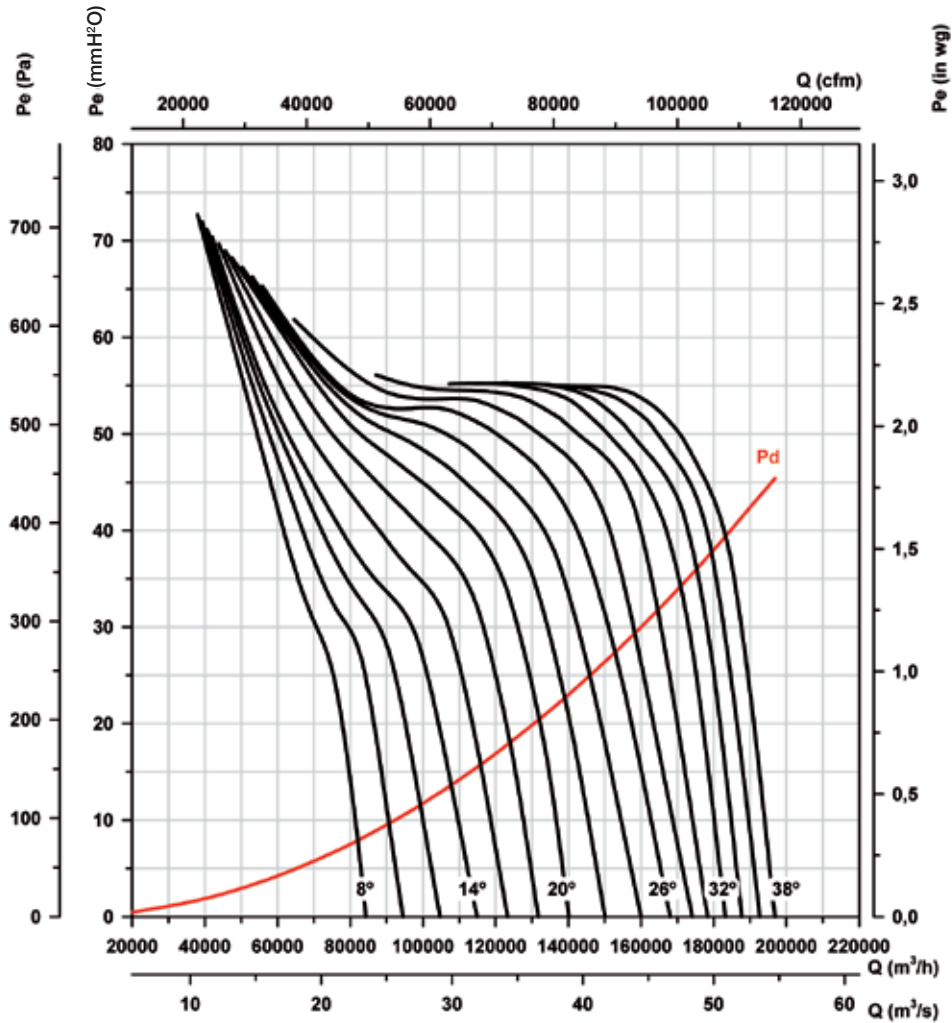

**Absorbed power**

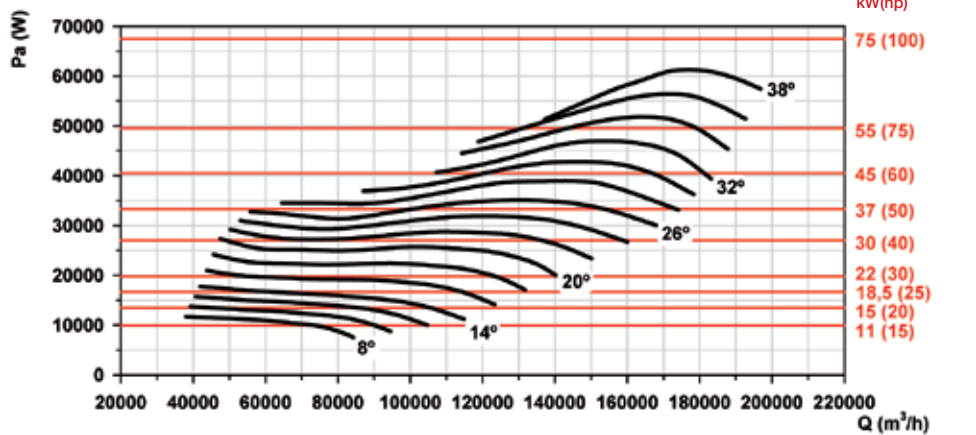

# HPX

## Tubular axial fans with external motors



Tubular axial fans activated by transmission with casing aperture up to 180°.

### Fan:

- Tubular casing with rotating cap, in sheet steel.
- Cast aluminium rotors.
- Sealed transmission unit (IP66) with double retention system.
- Airflow direction from Motor to Impeller.
- Maximum temperature of air to be carried: -25 °C +120 °C.

### Motor:

- IE3 efficiency motors for powers equal to or greater than 0.75kW except single-phase, 2-speed and 8-pole.
- Class F motors with ball bearings and IP55 protection.
- Multi voltage motor, special design valid for 220/380V 60Hz, 254/440V 60Hz, 265/460V 60Hz, 277/480V 60Hz.

### Finish:

- Anti-corrosive finish of polyester resin polymerised at 190 °C, previously degreased with phosphate-free nanotechnological treatment.

### On request:

- Airflow direction from Impeller to Motor.
- Rotors 100 % reversible.
- Special windings for different voltages.
- Category 2 ATEX certification (HPX/ATEX series version).

## Order code

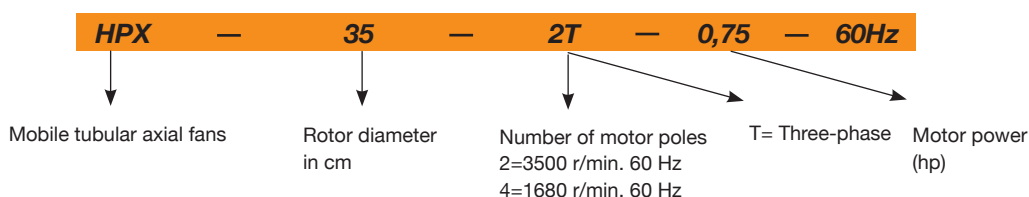

**60Hz**

## Technical characteristics

Model	Speed (r/min)	Max. admissible current (A)		Installed power (kW)	Maximum flow rate (m <sup>3</sup> /h)	Sound pres- sure level dB(A)	Approx. weight (kg)
		220-277V	380-480V				
HPX-35-2T-0.75	2720	2.36	1.36	0.55	4750	77	22
HPX-35-4T-0.33	1420	1.58	0.91	0.25	2500	60	20
HPX-45-4T-0.33	1200	1.58	0.91	0.25	6300	69	32
HPX-45-4T-0.50	1420	1.94	1.12	0.37	6600	70	35.5
HPX-50-4T-0.75	1310	2.51	1.45	0.55	9000	70	32.5
HPX-50-4T-1	1500	3.22	1.86	0.75	10800	71	34
HPX-56-4T-0.75	1380	2.51	1.45	0.55	11300	72	35.5
HPX-56-4T-1	1420	3.22	1.86	0.75	12200	73	35.5
HPX-56-4T-1.5	1420	4.59	2.65	1.10	14500	75	39
HPX-63-4T-1.5	1300	4.59	2.65	1.10	16000	74	59
HPX-63-4T-2	1420	5.98	3.45	1.50	17500	78	63
HPX-71-4T-1.5	1200	4.59	2.65	1.10	20300	78	73.5
HPX-71-4T-2	1350	5.98	3.45	1.50	22500	79	76.8
HPX-71-4T-3	1450	8.49	4.90	2.20	24000	81	85.2
HPX-80-4T-3	1200	8.49	4.90	2.20	29000	83	95
HPX-80-4T-4	1350	11.26	6.50	3.00	32000	84	100
HPX-80-4T-5.5	1450	14.38	8.30	4.00	40500	84	106
HPX-90-4T-5.5	1280	14.38	8.30	4.00	44000	89	118
HPX-90-4T-7.5	1400	11.40	6.50	5.50	51000	91	132
HPX-100-4T-10	1450	15.10	8.70	7.5	63000	93	159
HPX-100-4 T-15	1450	21.40	12.40	11.0	68000	94	181

**Acoustic characteristics**

The indicated values are determined by measuring the sound pressure level and sound power in dB(A) obtained in a free field at a distance equivalent to twice the size of the fan plus the rotor diameter, with a minimum of 1.5 m.

Sound power spectrum Lw(A) in dB(A) frequency band in [Hz]

Model	63	125	250	500	1000	2000	4000	8000	Model	63	125	250	500	1000	2000	4000	8000
35-2-0.75	48	63	82	81	82	81	76	67	71-4-1.5	55	75	83	88	90	87	80	69
35-4-0.33	31	46	65	64	65	64	59	50	74-4-2	56	76	84	89	91	88	81	70
45-4-0.33	40	55	74	73	74	73	68	59	71-4-3	65	76	86	92	93	88	77	73
45-4-0.50	41	56	75	74	75	74	69	60	80-4-3	60	80	88	93	95	92	85	74
50-4-0.75	44	58	77	77	78	76	72	63	80-4-4	61	81	89	94	96	93	86	75
50-4-1	45	59	78	78	79	77	73	64	80-4-5.5	68	79	89	95	96	91	80	76
56-4-0.75	47	67	75	80	82	79	72	61	90-4-5.5	67	88	95	100	103	99	92	81
56-4-1	48	68	76	81	83	80	73	62	90-4-7.5	69	90	97	102	105	101	94	83
56-4-1.5	57	68	78	84	85	80	69	65	100-4-10	73	93	101	106	108	105	98	87
63-4-1.5	51	71	79	84	86	83	76	65	100-4-15	74	94	102	107	109	106	99	88
63-4-2	62	73	83	89	90	85	74	70									

**Dimensions mm**

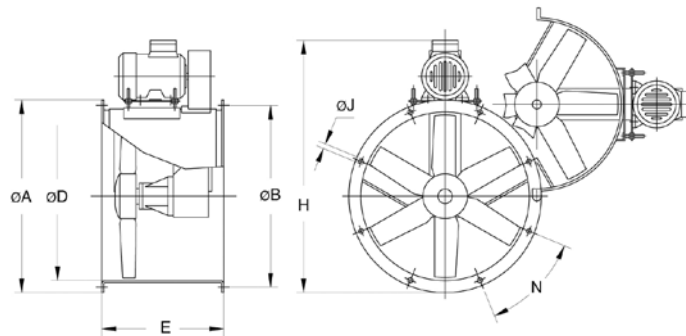

Model	ØA	ØB	ØD	E	H	ØJ	N	Model	ØA	ØB	ØD	E	H	ØJ	N
HPX-35-2T-0.75	425	395	355	380	606	10	8x45°	HPX-71-4T-1.5	810	770	710	550	1017	12	16x22°30'
HPX-35-4T-0.33	425	395	355	380	609	10	8x45°	HPX-71-4T-2	810	770	710	550	1017	12	16x22°30'
HPX-45-4T-0.33	540	500	460	420	740	12	8x45°	HPX-71-4T-3	810	770	710	550	1035	12	16x22°30'
HPX-45-4T-0.50	540	500	460	420	728	12	8x45°	HPX-80-4T-3	900	860	800	600	1173	12	16x22°30'
HPX-50-4T-0.75	600	560	512	420	803	12	12x30°	HPX-80-4T-4	900	860	800	600	1173	12	16x22°30'
HPX-50-4T-1	600	560	512	420	803	12	12x30°	HPX-80-4T-5.5	900	860	800	600	1200	12	16x22°30'
HPX-56-4T-0.75	660	620	560	450	848	12	12x30°	HPX-90-4T-5.5	1015	970	900	650	1320	15	16x22°30'
HPX-56-4T-1	660	620	560	450	848	12	12x30°	HPX-90-4T-7.5	1015	970	900	650	1320	15	16x22°30'
HPX-56-4T-1.5	660	620	560	450	870	12	12x30°	HPX-100-4T-10	1115	1070	1000	750	1483	15	16x22°30'
HPX-63-4T-1.5	730	690	640	500	950	12	12x30°	HPX-100-4T-15	1115	1070	1000	750	1513	15	16x22°30'
HPX-63-4T-2	730	690	640	500	950	12	12x30°								

**Characteristic curves**

Q= Flow rate in m³/h, m³/s and cfm.

Pe= Static pressure in mm H<sub>2</sub>O, Pa and inwg.

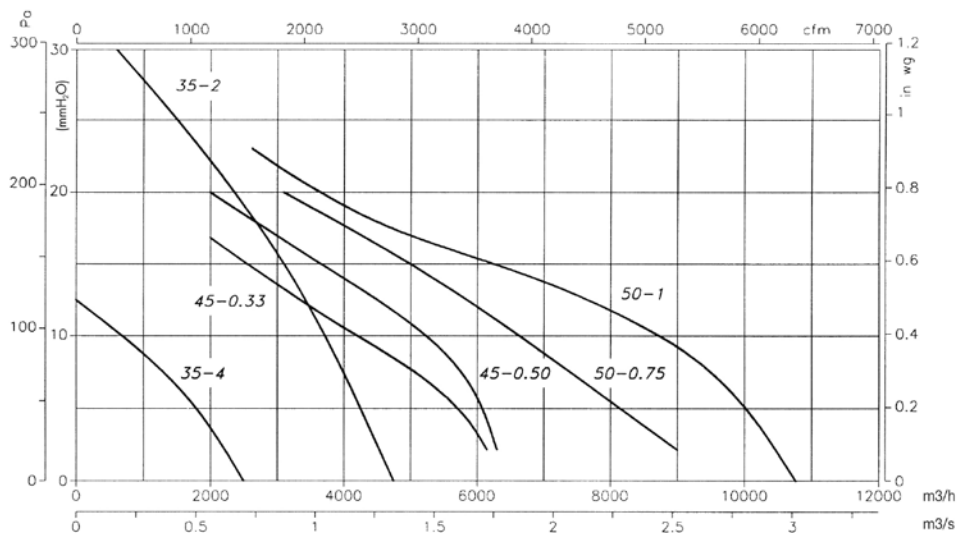

**Characteristic curves**

Q= Flow rate in m<sup>3</sup>/h, m<sup>3</sup>/s and cfm.

Pe= Static pressure in mm H<sub>2</sub>O, Pa and inwg.

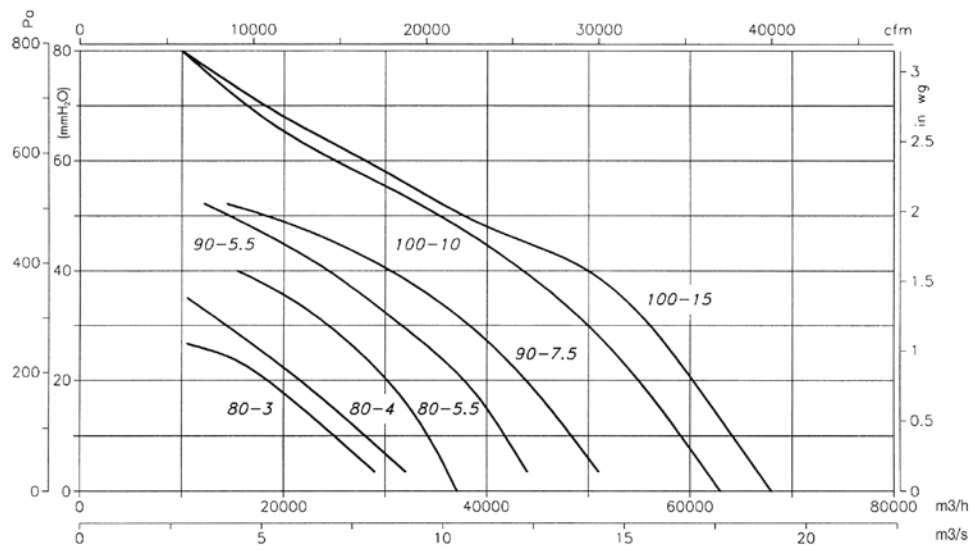
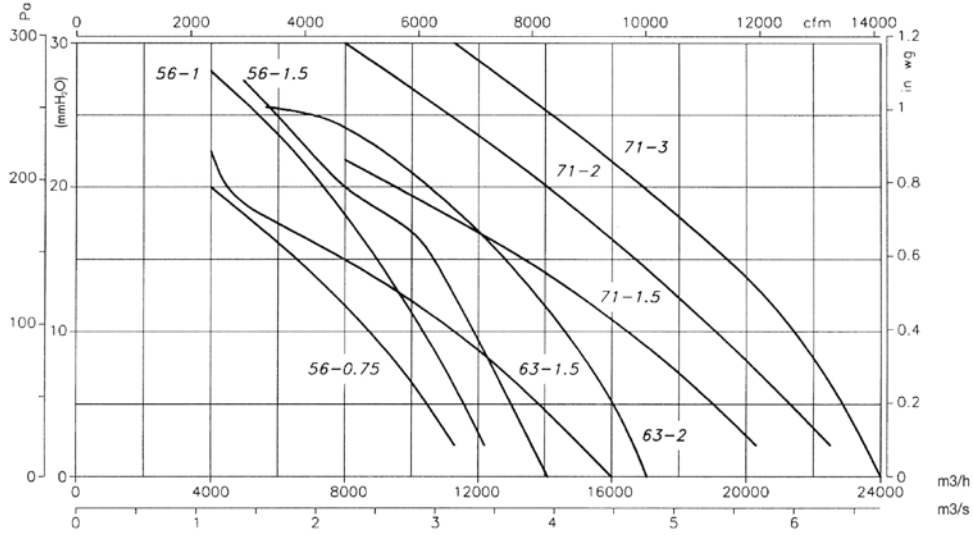

**Accessories**



INT

VSD3/A-RFT  
VSD1/A-RFM

CUADROS

RT

BTUB

BAC

PS

S

SI



# HBA

## Forked tubular axial fans with motor outside the air flow

Forked tubular fans for transferring air up to 150 °C in continuous operation and up to 200 °C in sporadic mode.



**Fan:**

- Sheet steel tubular casing.
- Cast aluminium rotor.
- Airflow direction from Impeller to Motor.

**Motor:**

- IE3 efficiency motors for powers equal to or greater than 0.75kW except single-phase, 2-speed and 8-pole.
- Class F motors with ball bearings and IP55 protection.
- Multi voltage motor, special design valid for 220/380V 60Hz, 254/440V 60Hz, 265/460V 60Hz, 277/480V 60Hz.
- Operating temperature: -25 °C. + 150 °C.

**Finish:**

- Anti-corrosive finish of polyester resin polymerised at 190 °C, previously degreased with phosphate-free nanotechnological treatment.

**On request:**

- Stainless steel casing.
- Hot dip galvanised finish.
- Special windings for different voltages and motors with PTC thermistors.

**Order code**

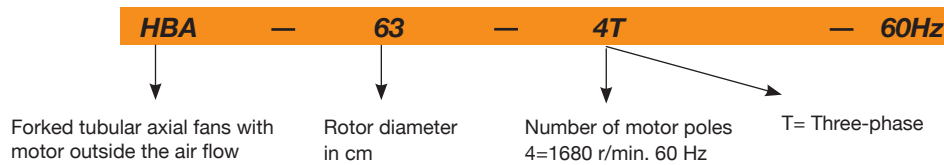

**60Hz**

**Technical characteristics**

Model	Speed (r/min)	Maximum admissible current (A)		Installed power (kW)	min./max. flow rate (m³/h)	Sound pressure level dB(A)	Approx. weight (kg)
		220-277V	380-480V				
HBA-31-2T	3456	2.24	1.29	0.55	2900	77	25
HBA-31-2M	3372	3.5	-	0.55	2900	77	26
HBA-31-4T	1638	1.25	0.72	0.25	1600	66	24
HBA-31-4M	1656	2.15	-	0.25	1600	66	25
HBA-40-2T	3444	4.35	2.5	1.1	6200	82	45
HBA-40-2M	3372	6.8	-	1.1	6200	82	46
HBA-40-4T	1650	1.67	0.96	0.37	3200	75	40
HBA-45-2T	3504	10.09	5.8	3	8550	84	57
HBA-50-4T	1698	2.87	1.65	0.75	6750	76	73
HBA-63-4T	1722	4.17	2.4	1.1	11150	77	91
HBA-71-4T	1734	15.3	8.8	4	15850	79	164
HBA-71-6T	1086	2.75	1.58	0.55	11200	74	140
HBA-80-6T	1122	5.22	3	1.1	14900	77	190
HBA-100-6T	1122	5.22	3	1.1	21700	80	260

**Dimensions mm**

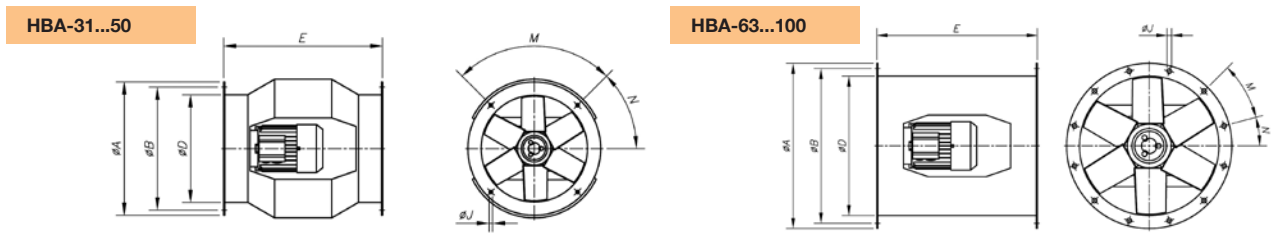

Model	ØA	ØB	ØD	E	ØJ	M	N
HBA-31	385	355	308	460	10	4x90°	45°
HBA-40	490	450	410	580	12	8x45°	22'5°
HBA-45	540	500	460	640	12	8x45°	22'5°
HBA-50	600	560	514	730	12	12x30°	15°
HBA-63	730	690	640	730	12	12x30°	15°
HBA-71	810	770	710	770	12	16x22'5°	11'25°
HBA-80	900	860	800	830	12	16x22'5°	11'25°
HBA-100	1115	1070	1000	1270	15	16x22'5°	11'25°

**Characteristic curves**

Q= Flow rate in m<sup>3</sup>/h, m<sup>3</sup>/s and cfm.

Pe= Static pressure in mm H<sub>2</sub>O, Pa and inwg.

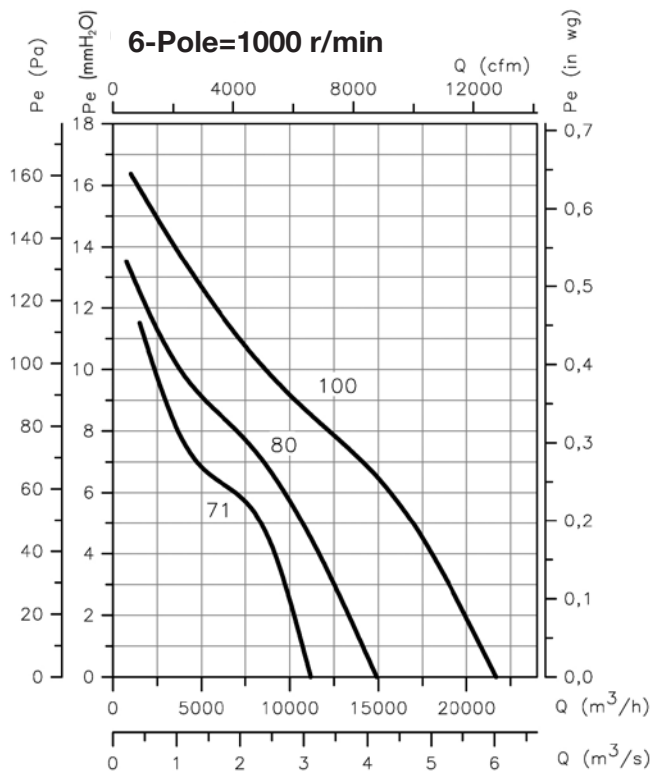
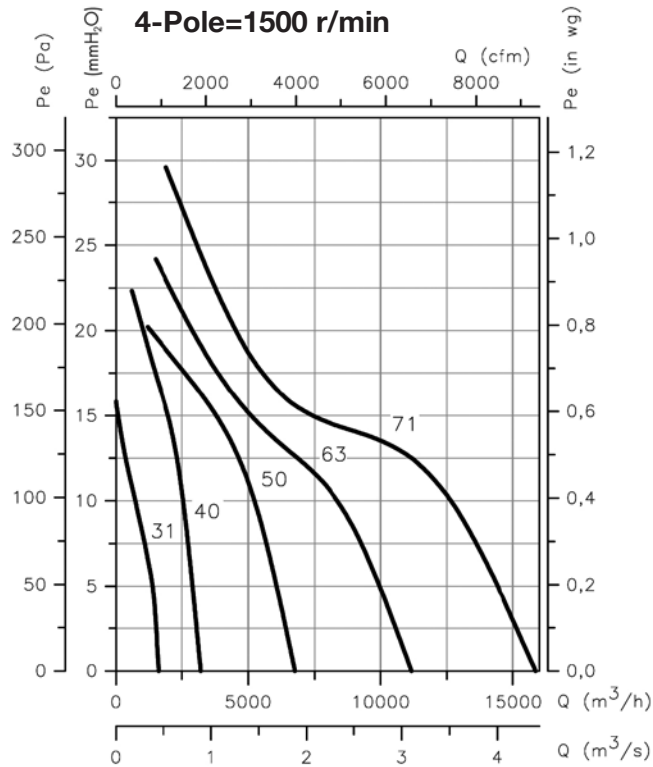
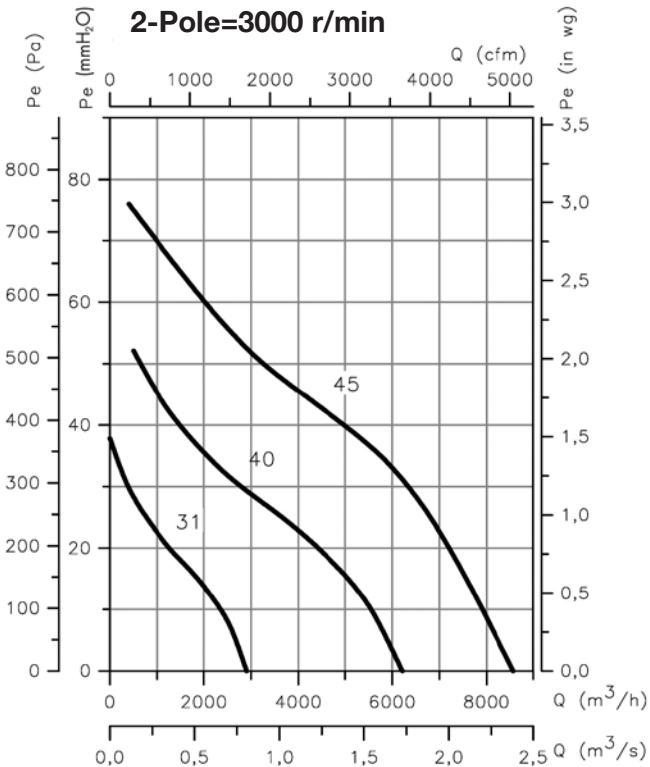

**Accessories**



INT VSD3/A-RFT VSD1/A-RFM CUADROS RT BTUB  
BAC PS S SI

## CENTRIFUGAL EXTRACTOR FANS

107

<b>CI-CO</b>  Long-range, low profile, centrifugal induction jet fans 110	<b>CMX</b>  VENT-SET belt-driven centrifugal extractor fans fitted with reaction impeller 111	<b>CBD</b>  Low-pressure, double inlet, centrifugal fans with direct-drive motors 120	<b>CJBD/ALG</b>  Ventilation units made of aluminium profiles and galvanised sheet steel with acoustic insulation 123	<b>CBX</b>  Centrifugal, double inlet, belt-driven fans 126
<b>CBXC</b>  Centrifugal, double inlet, belt-driven fans 126	<b>CBXR</b>  Centrifugal, double inlet, belt-driven fans 126	<b>CBXT</b>  Centrifugal, double inlet, belt-driven fans 126	<b>CJBX/ALG</b>  Belt-driven ventilation units made of aluminium profiles and galvanised sheet steel with acoustic insulation 136	<b>CDXR</b>  Double inlet, belt-driven fans 144
<b>CDXRT</b>  Double inlet, belt-driven fans 144	<b>CJDXR</b>  Double inlet, belt-driven ventilation units 144	<b>CSXR</b>  Single inlet, belt-driven fans 153	<b>CSXRT</b>  Single inlet, belt-driven fans 153	<b>CJSXR</b>  Single inlet, belt-driven ventilation units a transmisión 153
<b>TSA</b>  Single inlet, belt-driven fans 165	<b>TSAT</b>  Single inlet, belt-driven fans 165	<b>CJTSA</b>  Single inlet, belt-driven ventilation units 165	<b>CJBR</b>  Soundproof ventilation units with sandwich-panel and linear airflow between the inlet and outlet. 173	<b>CMP</b>  Medium pressure, centrifugal fans fitted with sheet steel or aluminium impeller 175
<b>CMR</b>  Extremely robust, medium pressure, centrifugal fans 183	<b>CMA</b>  Medium pressure, centrifugal fans with cast aluminium impeller 188	<b>CPV</b>  Centrifugal fans made of anti-corrosive plastic material 191	<b>CA</b>  High pressure centrifugal fans made of cast aluminium 196	<b>CAS</b>  High pressure centrifugal fans made of sheet steel 199
<b>CAS-S</b>  High pressure, centrifugal, fans made of sheet steel with acoustic attenuators 199				



## CENTRIFUGAL FANS

Since it was first established, Sodeca has specialised in the design and manufacture of fans and their accessories for industrial applications.

The combination of its experience gained over decades of working with fans and the technology provided by the engineers employed in its different departments has allowed Sodeca to occupy a leading international position as a fan manufacturer.

Industrial applications require an important capacity to adapt to the specifications of each project and flexibility in production in order to comply with the real needs of each client.

To comply with this objective, Sodeca has a standard products line and a specially-manufactured products line for building fans that meet the demands of our clients.

For many years, we have constantly invested in the development of processes and applications aimed at manufacturing and supplying special industrial fans with extremely tight deadlines in terms of their design and production.

The teamwork of our engineering department, in conjunction with universities and technological centres, and the close cooperation between the design departments of our external partners has made it possible to obtain new industrial fan solutions in a very short space of time.

During our history, we have developed all manner of fan technology for industrial applications in all parts of the world. Our aim is to continue to invest in this sector in order to become one of the most reputed global industrial fan manufacturers.



# OUR IMPELLERS

## **NEOLINEO impeller**

Axial-centrifugal impeller with a linear air direction design for operation at high pressures.



## **CBD impeller**

Double inlet, low pressure, multiblade impeller with reaction blades.



## **CDXR impeller**

Double inlet impeller with reaction blades for high flow rates.



## **CMP impeller**

Single inlet, medium pressure, multiblade impeller with reaction blades.



## **CMX impeller**

Medium pressure, single inlet impeller with reaction blades.



## **CMR impeller**

Extremely robust, high-performance, single inlet impeller with reaction blades for high flow rates and pressures.



## **CMRH impeller**

Extremely robust, high-performance single inlet impeller with reaction blades designed for working with high temperatures.



## **CA-CAM impeller**

Impellers designed to obtain high pressures.



## **CMT impeller**

Extremely robust impellers, designed to carry dust and solids.



# CI-CO

## Long-range, low profile, centrifugal induction jet fans

Long range, inductive, low profile, one-way or reversible jet fans, for air movement and CO extraction in car parks.



Support feet

### Fan:

- Sheet steel casing.
- Impeller with reaction blades in extremely robust sheet steel.
- INT series safety switch built into the fan.
- Support feet included.

### Motor:

- Class F motors with ball bearings, IP55 protection and with 1 or 2 speeds, depending on model.
- Three-phase 220-254V. 60Hz. and 380-440V. 60Hz.
- Maximum temperature of air to be carried: -20 °C +40 °C.

### Finish:

- Anti-corrosive finish of polyester resin polymerised at 190 °C, previously degreased with phosphate-free nanotechnological treatment.

### On request:

- Version approved for smoke evacuation in accordance with standard EN 12101-3 (see CI series).

## Order code

<b>CI-CO</b>	—	<b>50</b>	—	<b>4T</b>	—	<b>60Hz</b>
↓		↓		↓		
Long-range, low profile, centrifugal induction jet fans		Rotor diameter in cm		Number of motor poles 4=1680 r/min. 60 Hz 6=1080 r/min. 60 Hz 8=900 r/min. 60 Hz	T= Three-phase	

**60Hz**

## Technical characteristics

Model	Speed (r/min)	Maximum admissible current (A)		Flow rate (m³/h)	Thrust (N)	Installed power (kW)	Sound pressure LpA at 1m dB(A)	Approx. weight (kg)
		220-254V	380-440V					
CI-CO-50-4T	1674	5.00	2.90	6050	50	1.20	78	83
CI-CO-50-4/8T	1674/780		2.90 / 1.20	6050 / 3020	50 / 13	1.20 / 0.30	78/63	83
CI-CO-75-4T	1740	9.00	5.20	8080	75	2.20	85	139
CI-CO-75-4/8T	1740/876		5.20 / 2.05	8080 / 4040	75 / 19	2.20 / 0.37	85/70	139
CI-CO-100-4T	1734	9.90	5.70	9340	100	2.40	89	141
CI-CO-100-4/8T	1734/858		5.70 / 2.20	9340 / 4670	100 / 25	2.40 / 0.55	89/14	141

## Dimensions mm

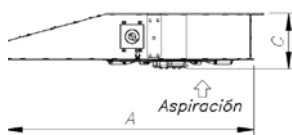
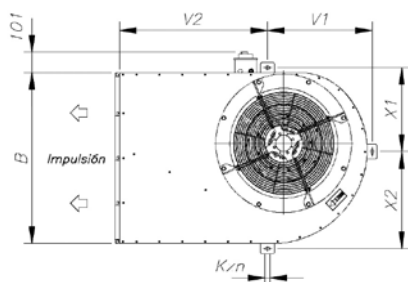

Model	A	B	C	V2	V1	X1	X2	Kxn
CI-CO-50	1240	840	272.5	741.5	524.5	413	477	12x26
CI-CO-75	1778	1040	311	1143	662	494	596	12x26
CI-CO-100	1778	1040	323	1143	662	494	596	12x26

## Accessories



# CMX

## VENT-SET centrifugal extractor fans, belt-driven and fitted with a reaction impeller

Belt-driven VENT-SET centrifugal extractors with reaction impeller fitted with electric motors and a standardised set of pulleys, belts and protectors in accordance with standards EN-294 and ISO-13852.



Extremely robust, high performance reaction impeller

**Fan:**

- Sheet steel casing.
- Impeller with reaction blades made of sheet steel.
- Standardised set of pulleys, belts and protectors in accordance with standard EN-294 and ISO-13852.
- Fitted with an inspection hatch.

**Motor:**

- IE3 efficiency motors for powers equal to or greater than 0.75kW except single-phase, 2-speed and 8-pole.
- Class F motors with ball bearings and IP55 protection.
- Multi voltage motor, special design valid for 220/380V 60Hz, 254/440V 60Hz, 265/460V 60Hz, 277/480V 60Hz.
- Maximum temperature of air to be carried: -20 °C + 150 °C.

**Finish:**

- Anti-corrosive finish of polyester resin polymerised at 190 °C, previously degreased with phosphate-free nanotechnological treatment.

**On request:**

- Special windings for different voltages.

### Order code



CMX: Centrifugal, belt-driven extractor fans fitted with a reaction impeller

Impeller size

Motor power (hp)

60Hz

### Technical characteristics

Model	Speed (r/min)	Maximum admissible current (A)		Installed power (kW)	Maximum flow rate (m³/h)	Approx. weight (kg)
		220-277V	380-480V			
CMX-250-0.25	1920	0.96	0.55	0.18	1575	22
CMX-250-0.33	2140	1.36	0.78	0.25	1755	23
CMX-250-0.5	2435	1.84	1.06	0.37	2000	24
CMX-250-0.75	2775	2.57	1.49	0.55	2275	26
CMX-250-1	3075	2.78	1.60	0.75	2525	28
CMX-250-1.5	3490	4.20	2.40	1.10	2865	30
CMX-280-0.33	1760	1.36	0.78	0.25	2030	25
CMX-280-0.5	2010	1.84	1.06	0.37	2315	26
CMX-280-0.75	2305	2.57	1.49	0.55	2655	28
CMX-280-1	2560	2.78	1.60	0.75	2950	30
CMX-280-1.5	2910	4.20	2.40	1.10	3355	32
CMX-280-2	3225	5.44	3.13	1.50	3720	35
CMX-315-0.5	1650	1.84	1.06	0.37	2700	30
CMX-315-0.75	1880	2.57	1.49	0.55	3075	32
CMX-315-1	2095	2.78	1.60	0.75	3430	34
CMX-315-1.5	2375	4.20	2.40	1.10	3885	36
CMX-315-2	2655	5.44	3.13	1.50	4345	39
CMX-315-3	3000	7.77	4.47	2.20	4910	42
CMX-315-4	3380	10.18	5.88	3.00	5530	47
CMX-355-0.5	1385	1.84	1.06	0.37	3235	39
CMX-355-0.75	1580	2.57	1.49	0.55	3685	41
CMX-355-1	1765	2.78	1.60	0.75	4120	44
CMX-355-1.5	2010	4.20	2.40	1.10	4690	46
CMX-355-2	2225	5.44	3.13	1.50	5190	48
CMX-355-3	2530	7.77	4.47	2.20	5905	53
CMX-355-4	2860	10.18	5.88	3.00	6675	57
CMX-355-5.5	3100	13.60	7.82	4.00	7235	63
CMX-400-0.75	1320	2.28	1.31	0.55	4375	49
CMX-400-1	1465	3.10	1.79	0.75	4855	52
CMX-400-1.5	1665	4.03	2.32	1.10	5515	54
CMX-400-2	1845	5.96	3.44	1.50	6110	56
CMX-400-3	2100	8.36	4.83	2.20	6955	59
CMX-400-4	2370	10.18	5.88	3.00	7850	64
CMX-400-5.5	2610	13.60	7.82	4.00	8645	72
CMX-450-0.75	1095	2.28	1.31	0.55	5045	61

### Technical characteristics

Model	Speed (r/min)	Maximum admissible current (A)		Installed power (kW)	Maximum flow rate (m³/h)	Approx. weight (kg)
		220-277V	380-480V			
CMX-450-1	1220	3.10	1.79	0.75	5620	64
CMX-450-1.5	1390	4.03	2.32	1.10	6405	66
CMX-450-2	1540	5.96	3.44	1.50	7095	68
CMX-450-3	1750	8.36	4.83	2.20	8065	72
CMX-450-4	1980	10.18	5.88	3.00	9120	76
CMX-450-5.5	2180	13.60	7.82	4.00	10045	85
CMX-450-7.5	2420		10.50	5.50	11150	95
CMX-450-10	2670		14.50	7.50	12300	100
CMX-500-1	1005	3.10	1.79	0.75	6465	86
CMX-500-1.5	1140	4.03	2.32	1.10	7330	88
CMX-500-2	1270	5.96	3.44	1.50	8165	90
CMX-500-3	1445	8.36	4.83	2.20	9290	93
CMX-500-4	1635	10.96	6.33	3.00	10510	98
CMX-500-5.5	1800	14.10	8.12	4.00	11570	107
CMX-500-7.5	2000		10.50	5.50	12855	116
CMX-500-10	2220		14.50	7.50	14270	121
CMX-500-15	2300		20.20	11.00	14785	155
CMX-560-2	1035	5.96	3.44	1.50	9885	100
CMX-560-3	1185	8.36	4.83	2.20	11360	103
CMX-560-4	1340	10.96	6.33	3.00	12880	108
CMX-560-5.5	1475	14.10	8.12	4.00	14210	117
CMX-560-7.5	1640		11.60	5.50	15830	122
CMX-560-10	1815		14.50	7.50	17555	132
CMX-560-15	2065		20.20	11.00	20010	166
CMX-630-3	1010	8.36	4.83	2.20	12120	119
CMX-630-4	1140	10.96	6.33	3.00	13680	123
CMX-630-5.5	1255	14.10	8.12	4.00	15060	132
CMX-630-7.5	1395		11.60	5.50	16740	138
CMX-630-10	1550		14.50	7.50	18600	147
CMX-630-15	1760		20.20	11.00	21120	181
CMX-630-20	1900		27.50	15.00	22800	202
CMX-710-4	960	10.96	6.33	3.00	17065	186
CMX-710-5.5	1060	14.10	8.12	4.00	18845	195
CMX-710-7.5	1180		11.60	5.50	20980	200
CMX-710-10	1305		14.20	7.50	23200	210
CMX-710-15	1485		20.20	11.00	26400	244
CMX-710-20	1670		27.50	15.00	29690	265
CMX-710-25	1750		35.00	18.50	31110	285
CMX-800-4	765	10.96	6.33	3.00	19975	226
CMX-800-5.5	845	14.10	8.12	4.00	22065	234
CMX-800-7.5	940		11.60	5.50	24545	240
CMX-800-10	1040		14.50	7.50	27155	250
CMX-800-15	1185		20.20	11.00	30940	284
CMX-800-20	1330		27.50	15.00	34730	305
CMX-800-25	1420		35.00	18.50	37080	325
CMX-900-4	640	10.96	6.33	3.00	21200	281
CMX-900-5.5	705	14.10	8.12	4.00	23355	289
CMX-900-7.5	785		11.60	5.50	26005	295
CMX-900-10	870		14.50	7.50	28820	305
CMX-900-15	990		20.20	11.00	32795	339
CMX-900-20	1100		27.50	15.00	36440	360
CMX-900-25	1150		35.00	18.50	38095	380
CMX-900-30	1200		42.00	22.00	39750	399
CMX-1000-5.5	575	14.10	8.12	4.00	25555	342
CMX-1000-7.5	645		11.60	5.50	28665	348
CMX-1000-10	715		14.50	7.50	31780	358
CMX-1000-15	815		20.20	11.00	36220	392
CMX-1000-20	915		27.50	15.00	40665	413
CMX-1000-25	980		35.00	18.50	43555	432
CMX-1000-30	1040		42.00	22.00	46220	452
CMX-1000-40	1120		55.00	30.00	49780	506

### Accessories





Dimensions mm

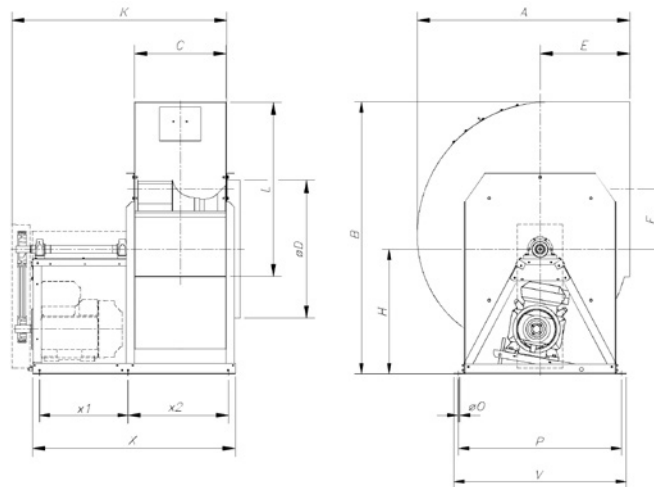

Model	A	B	C	L	øD	H	E	F	K	X	øO	P	V	x1	x2
CMX-250	437	637	180	320	248	336	209	111	582	572	10	370	410	270	242
CMX-280	468	707.5	197	361	278	376	215	121	600	590	10	410	450	270	260
CMX-315	522	741.5	223	404	313	400	236	139.5	748.5	691.5	12	454	504	315	306.5
CMX-355	582.5	839.5	247	453	353	450	261	158	772.5	715.5	12	496	546	315	330.5
CMX-400	651	933	274	507	398	500	290	179.5	799.5	742.5	12	542	592	315	357.5
CMX-450	727.5	1037	308	569	448	550	322	202.5	938.5	841.5	12	595	645	380	391.5
CMX-500	801	1140	344	638	498	600	352	221	974.5	887.5	12	654	704	380	437.5
CMX-560	892.5	1255	383	715	558	650	390	247.5	1171.5	1076.5	12	715	765	515	484
CMX-630	998.5	1449.5	432	801	628	769	434	280	1220.5	1125.5	12	780	830	515	533
CMX-710	1117	1507	479	902	708	730	481.5	316	1267.5	1172.5	14	890	930	515	580
CMX-800	1250	1615.5	533	1010	798	762	535	358.5	1321.5	1231.5	14	980	1050	515	614
CMX-900	1408	1475	595	1130	898	850	604	407	1383.5	1293.5	14	1080	1150	515	676
CMX-1000	1541	1966	663	1260	998	900	651	433	1559.5	1468.5	14	1180	1250	642	729.5

Characteristic curves

Q= Flow rate in m³/h, m³/s and cfm.

Pe= Static pressure in mm H<sub>2</sub>O, Pa and inwg.

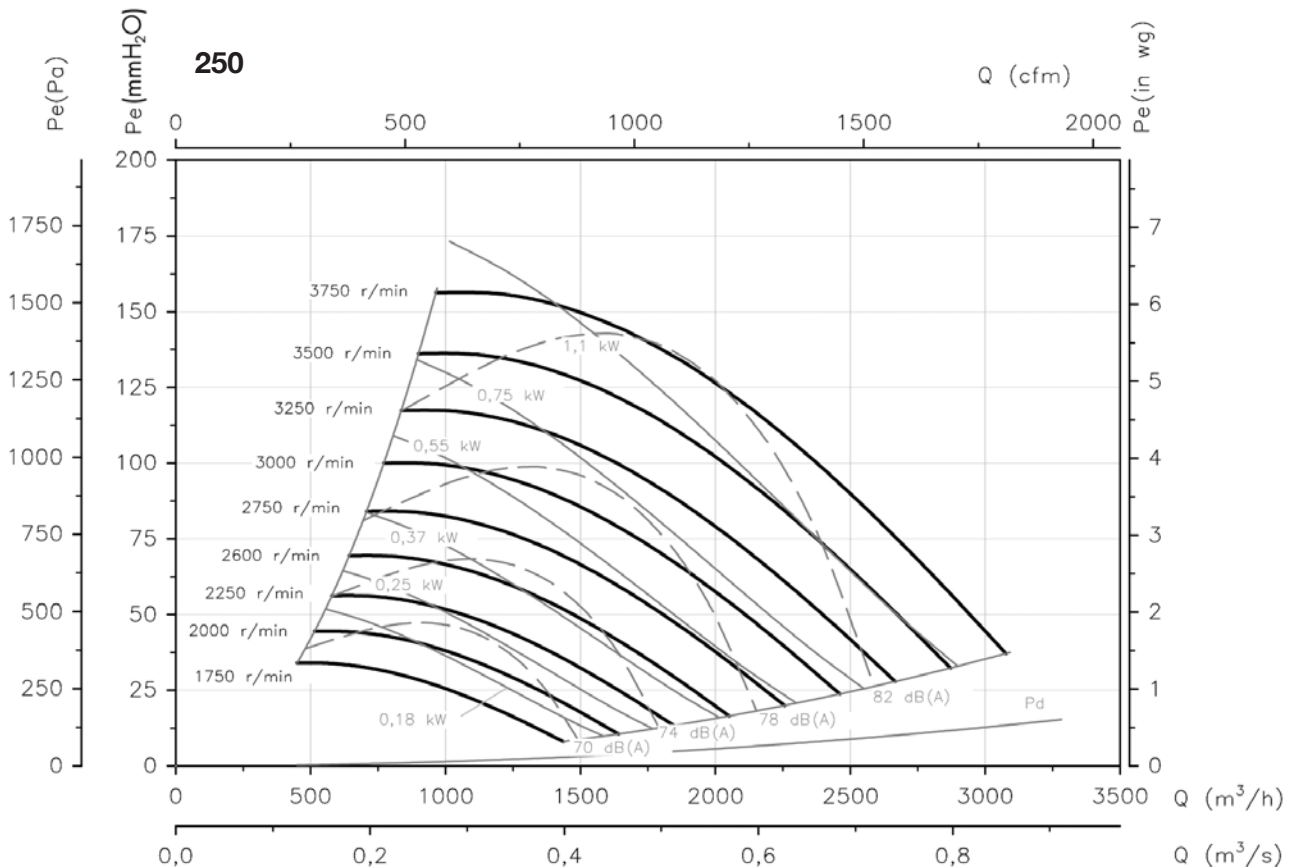

**Characteristic curves**

Q= Flow rate in m<sup>3</sup>/h, m<sup>3</sup>/s and cfm.

Pe= Static pressure in mm H<sub>2</sub>O, Pa and inwg.

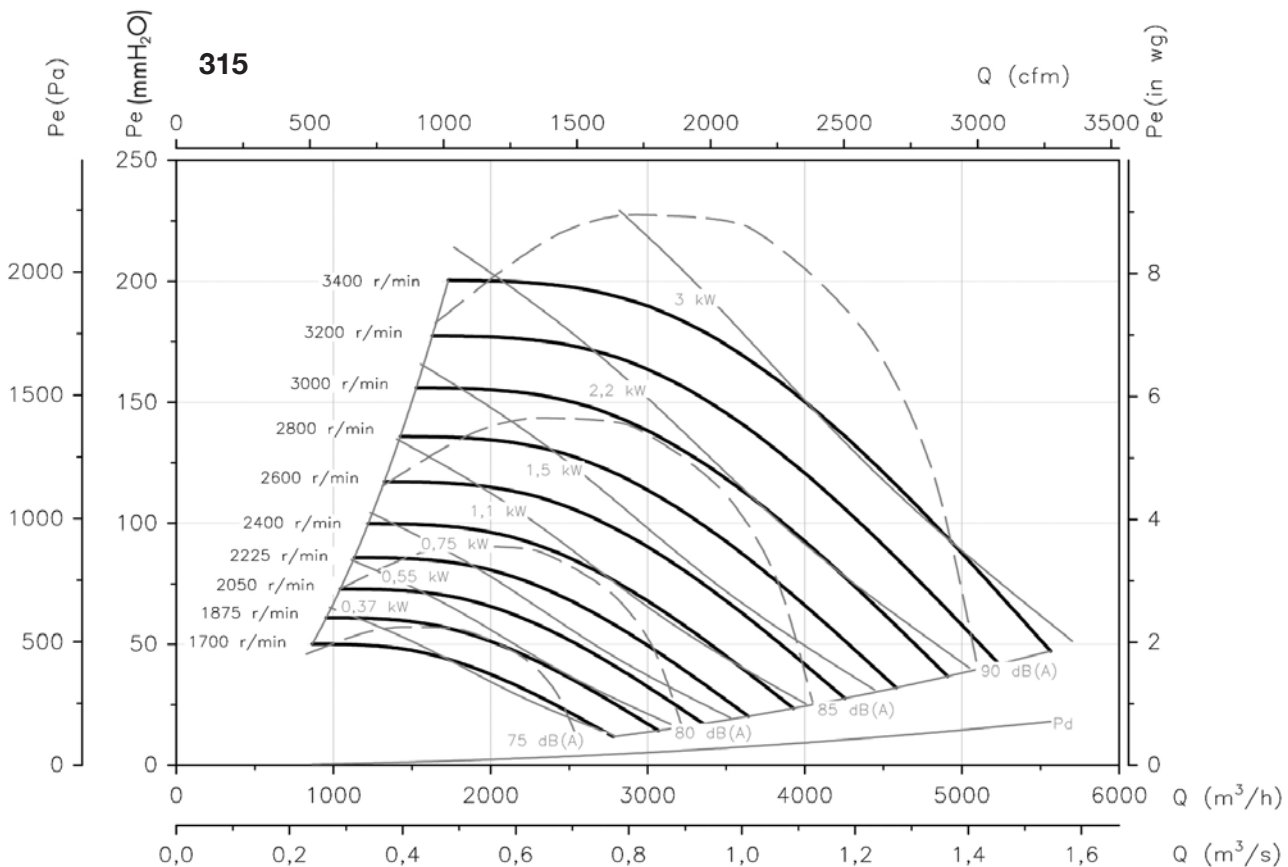
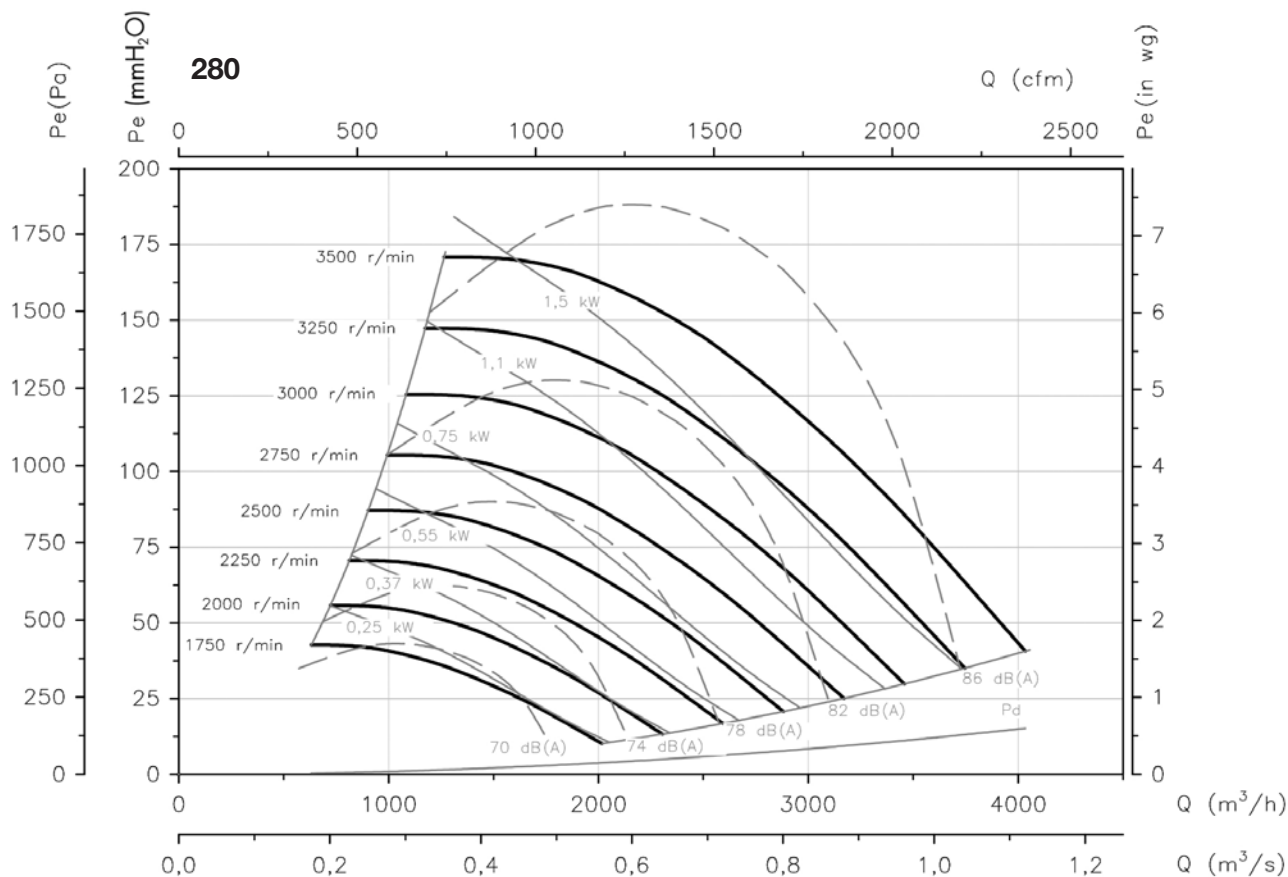

**Characteristic curves**

Q= Flow rate in m<sup>3</sup>/h, m<sup>3</sup>/s and cfm.

Pe= Static pressure in mm H<sub>2</sub>O, Pa and inwg.

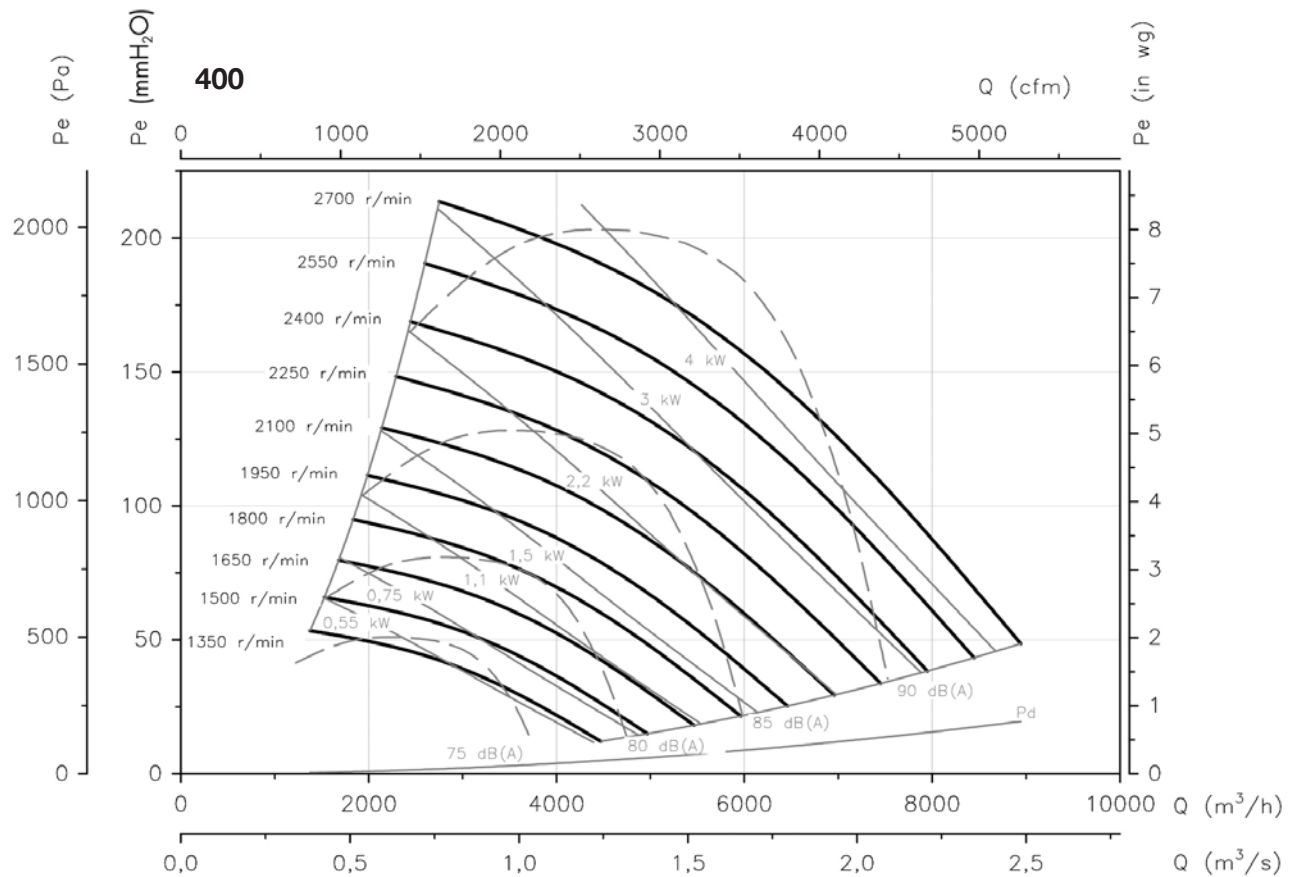
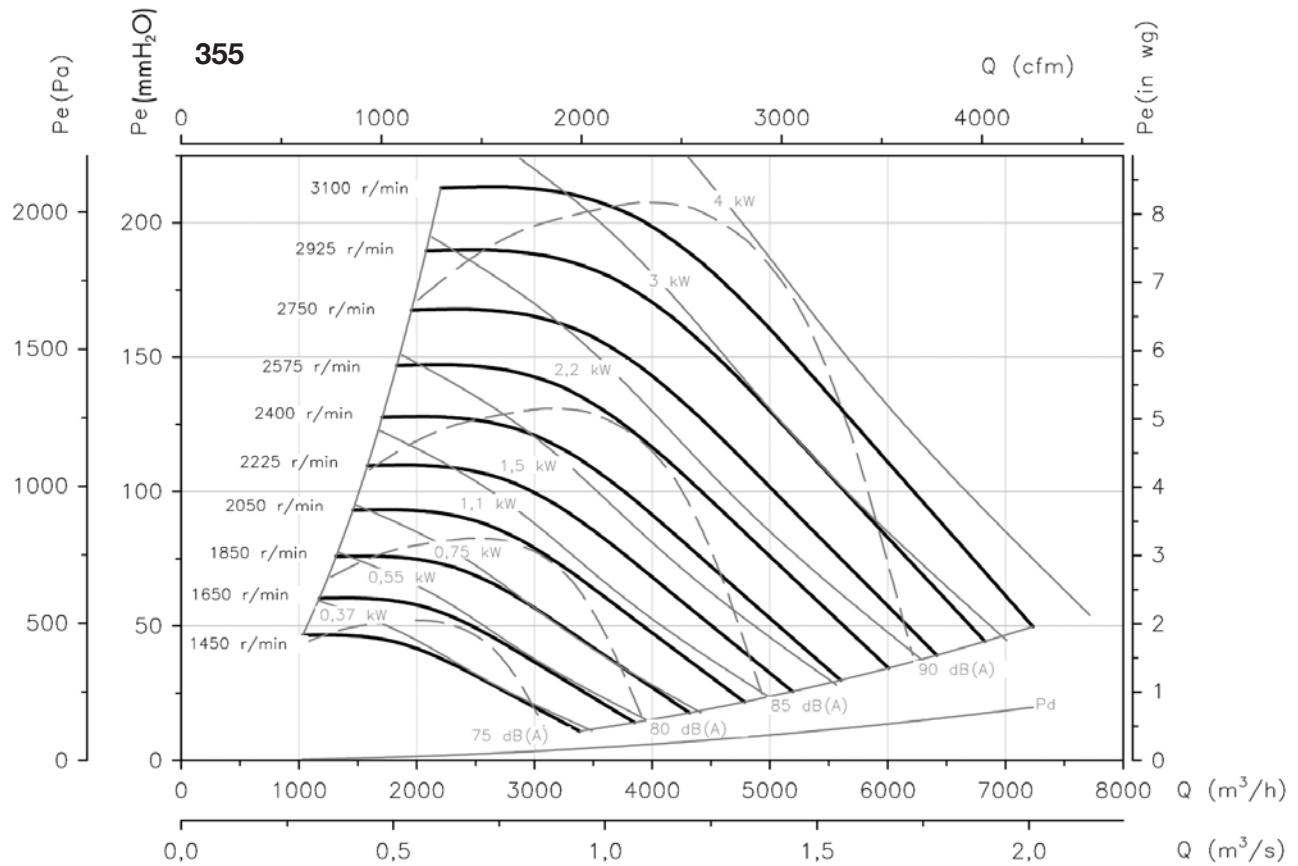

**Characteristic curves**

Q= Flow rate in m<sup>3</sup>/h, m<sup>3</sup>/s and cfm.

Pe= Static pressure in mm H<sub>2</sub>O, Pa and inwg.

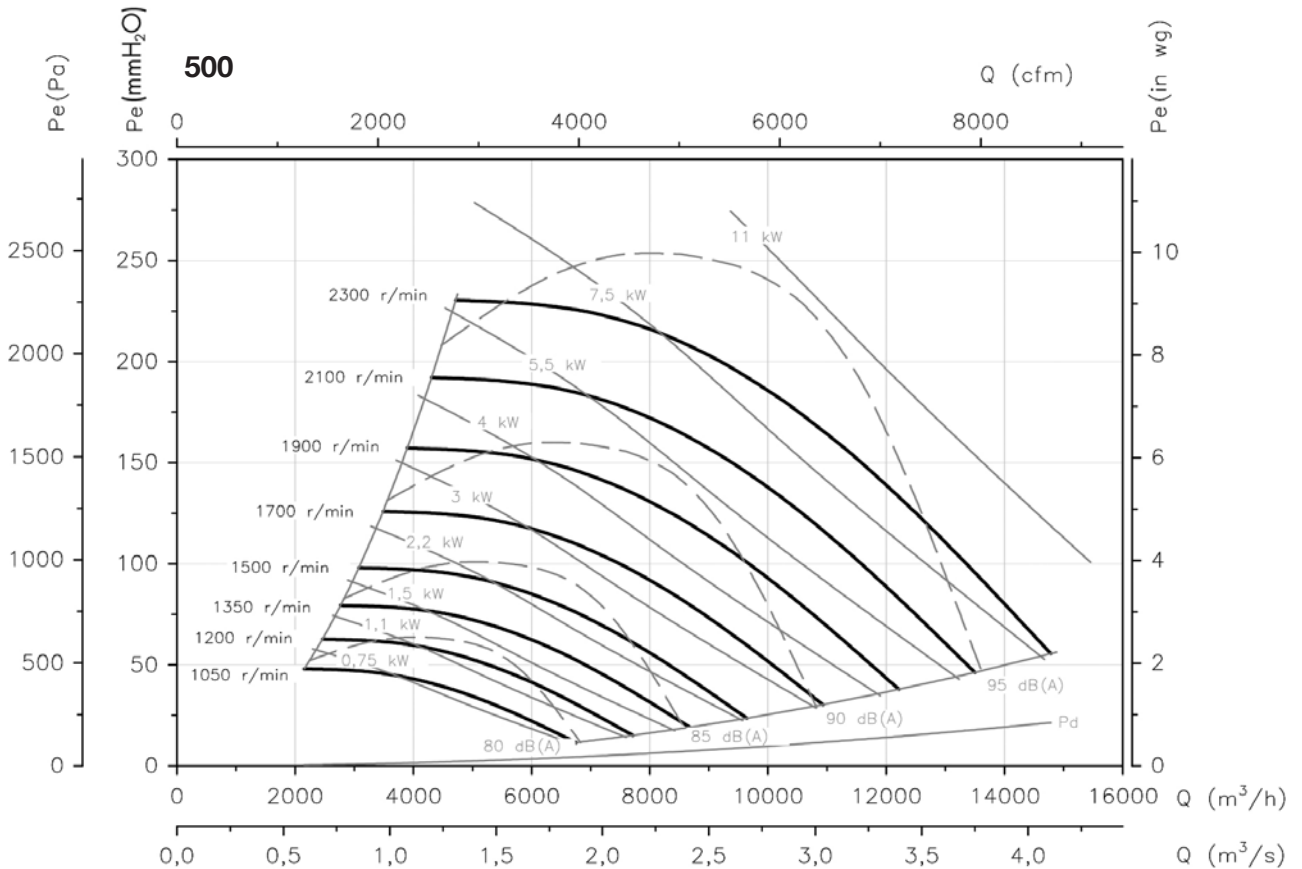
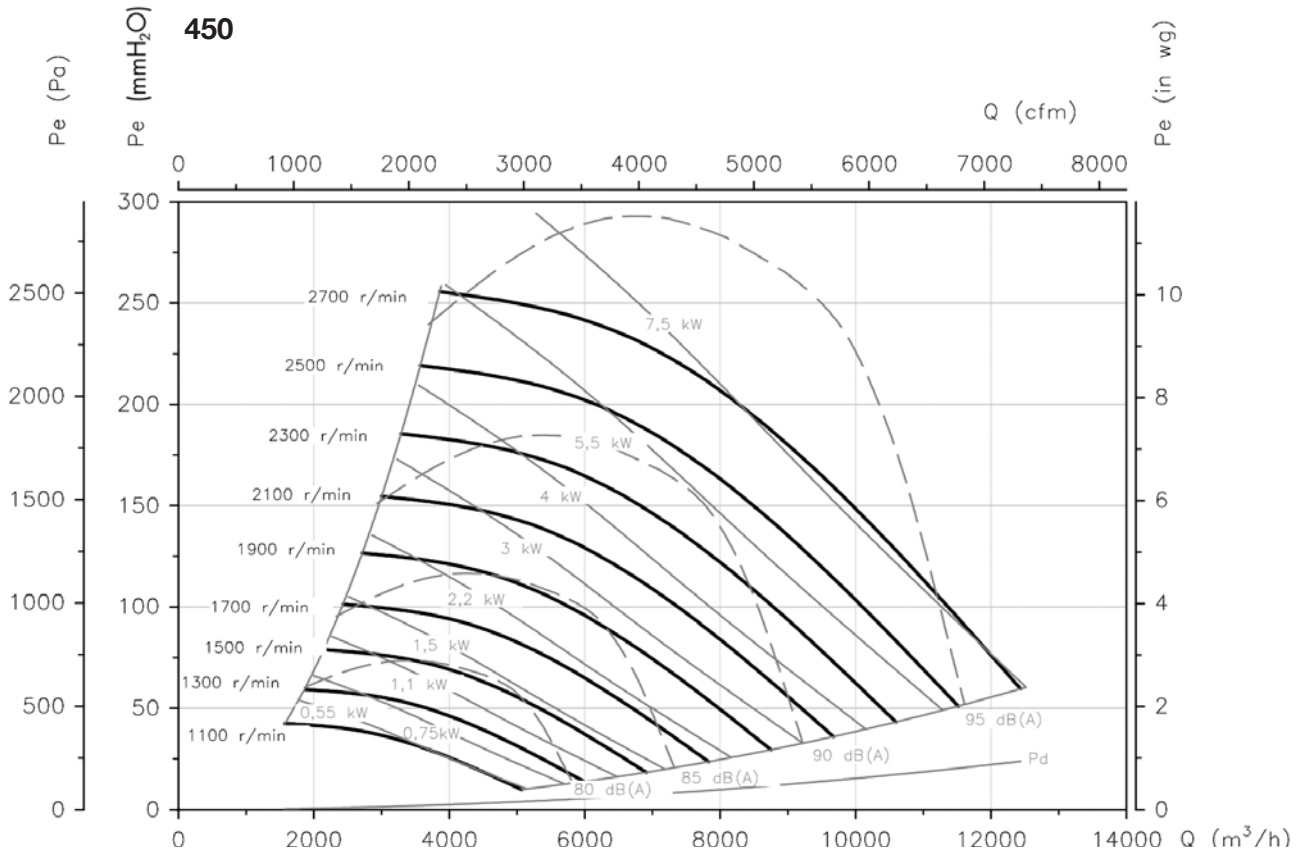

**Characteristic curves**

Q= Flow rate in m<sup>3</sup>/h, m<sup>3</sup>/s and cfm.

Pe= Static pressure in mm H<sub>2</sub>O, Pa and inwg.

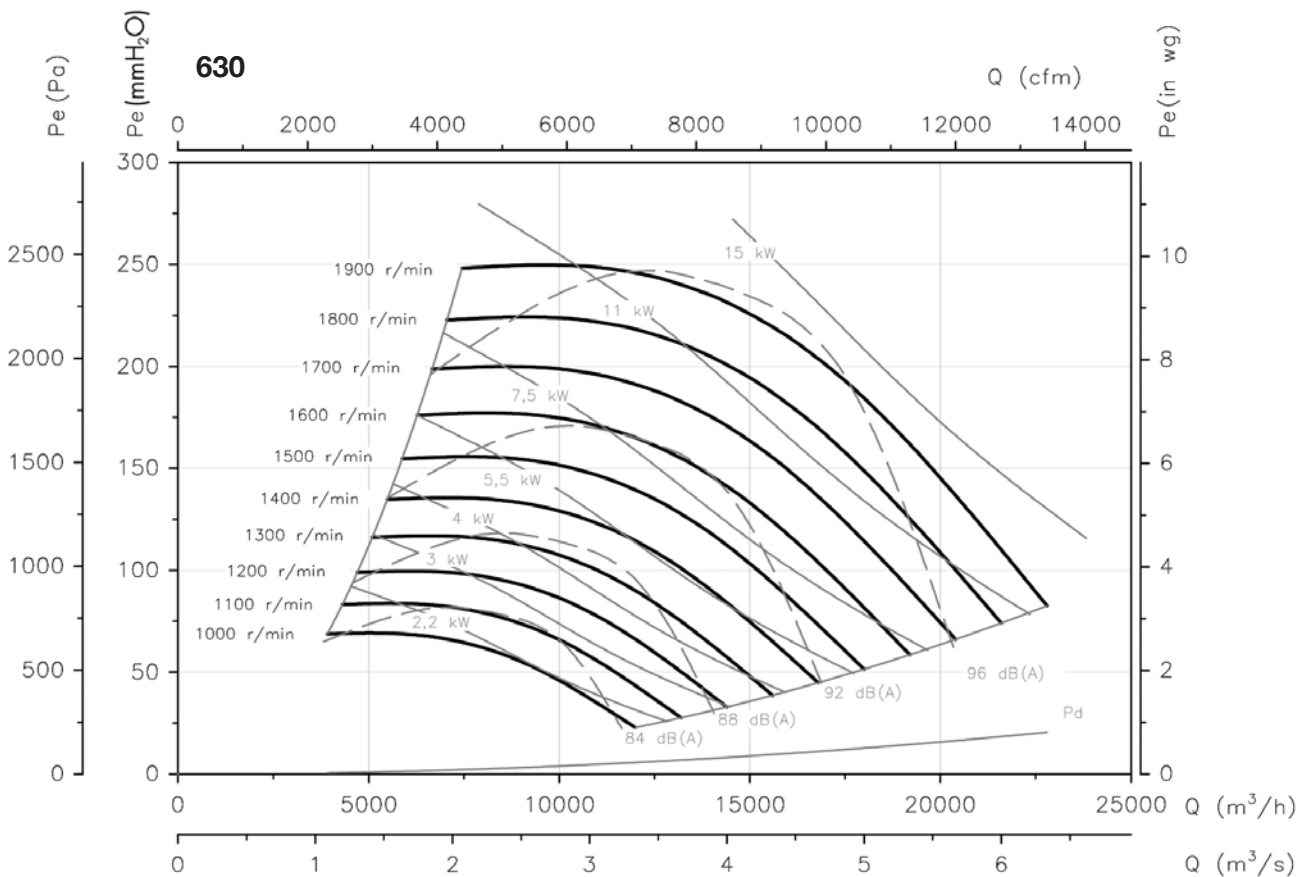
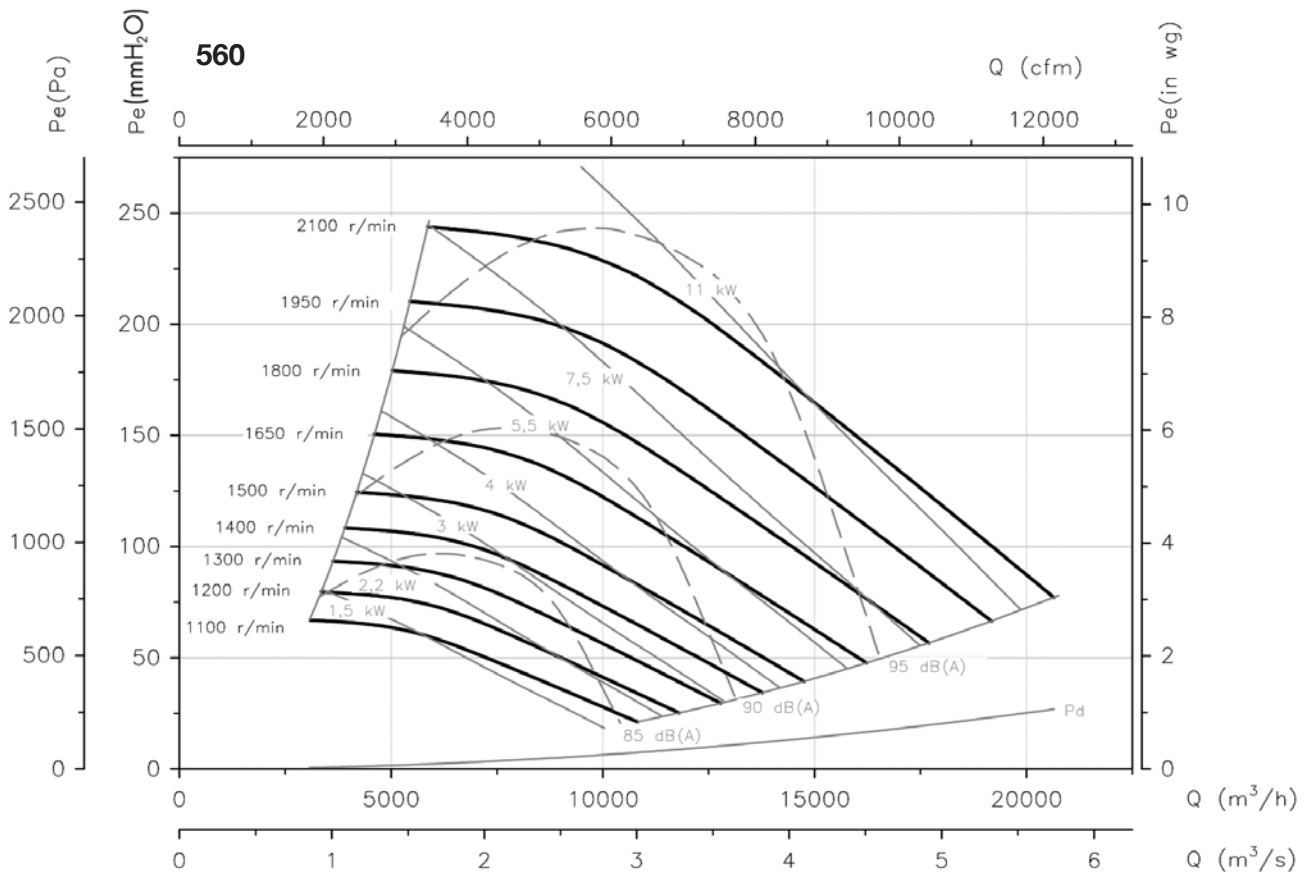

**Characteristic curves**

Q= Flow rate in m<sup>3</sup>/h, m<sup>3</sup>/s and cfm.

Pe= Static pressure in mm H<sub>2</sub>O, Pa and inwg.

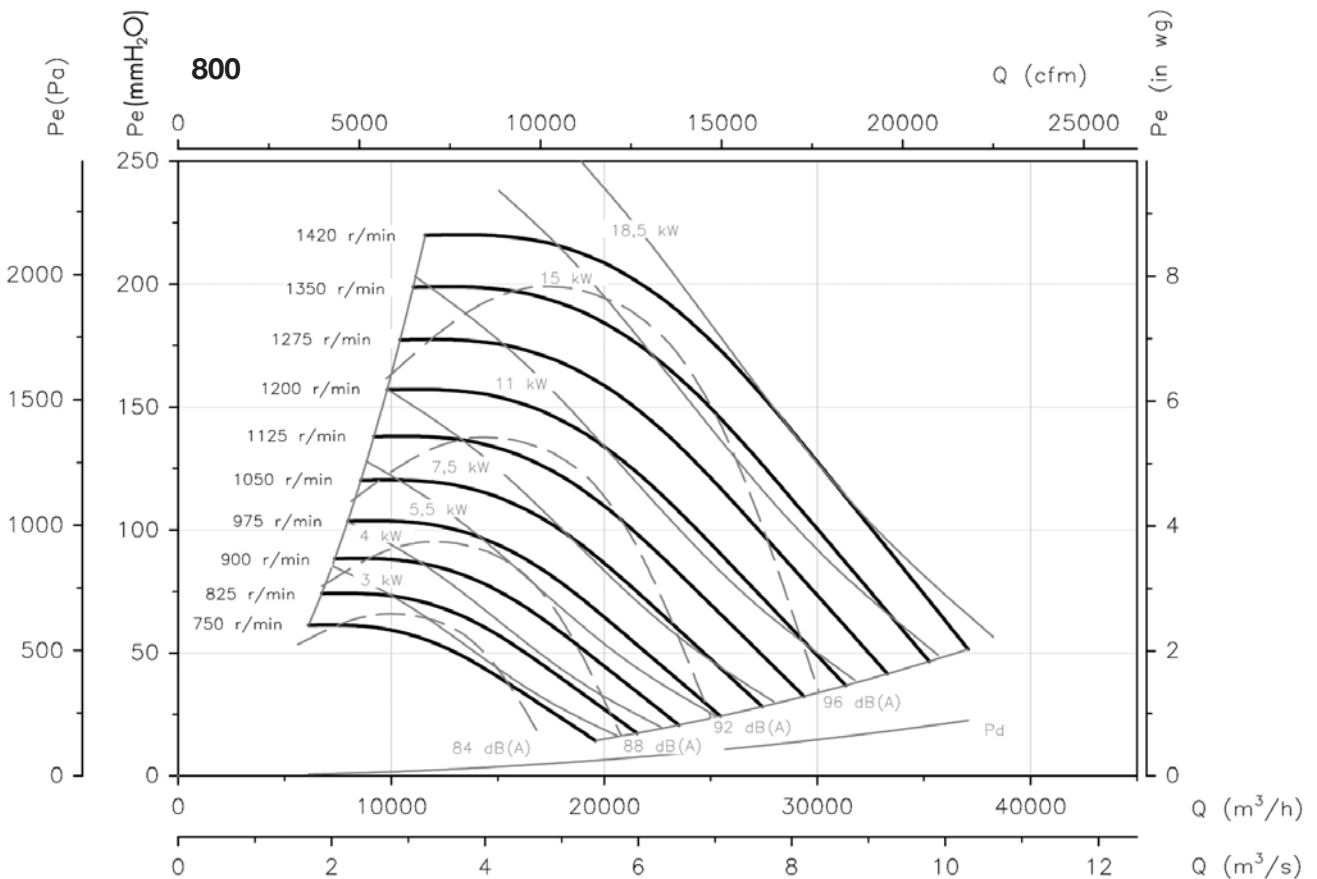
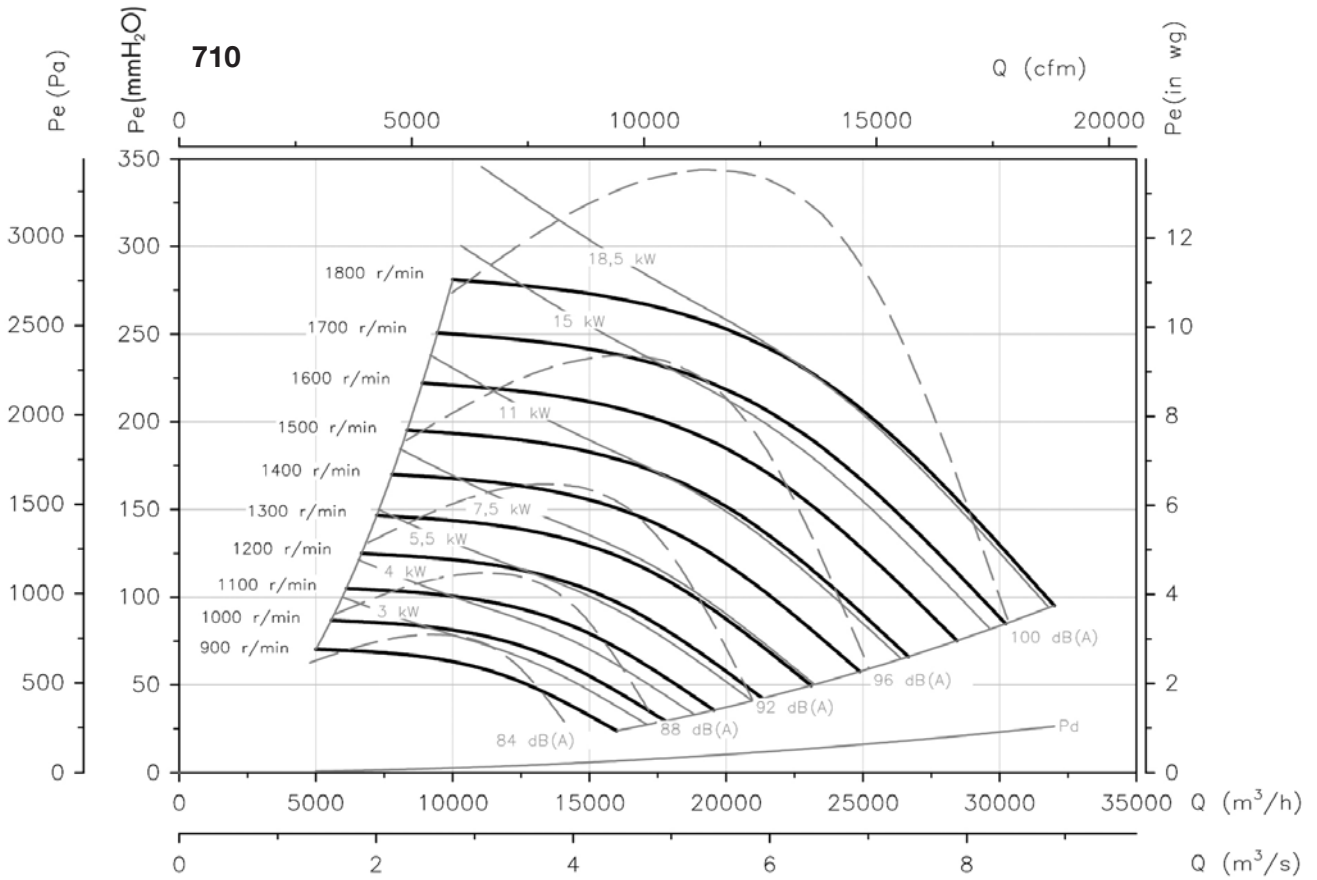

**Characteristic curves**

Q= Flow rate in m<sup>3</sup>/h, m<sup>3</sup>/s and cfm.

Pe= Static pressure in mm H<sub>2</sub>O, Pa and inwg.

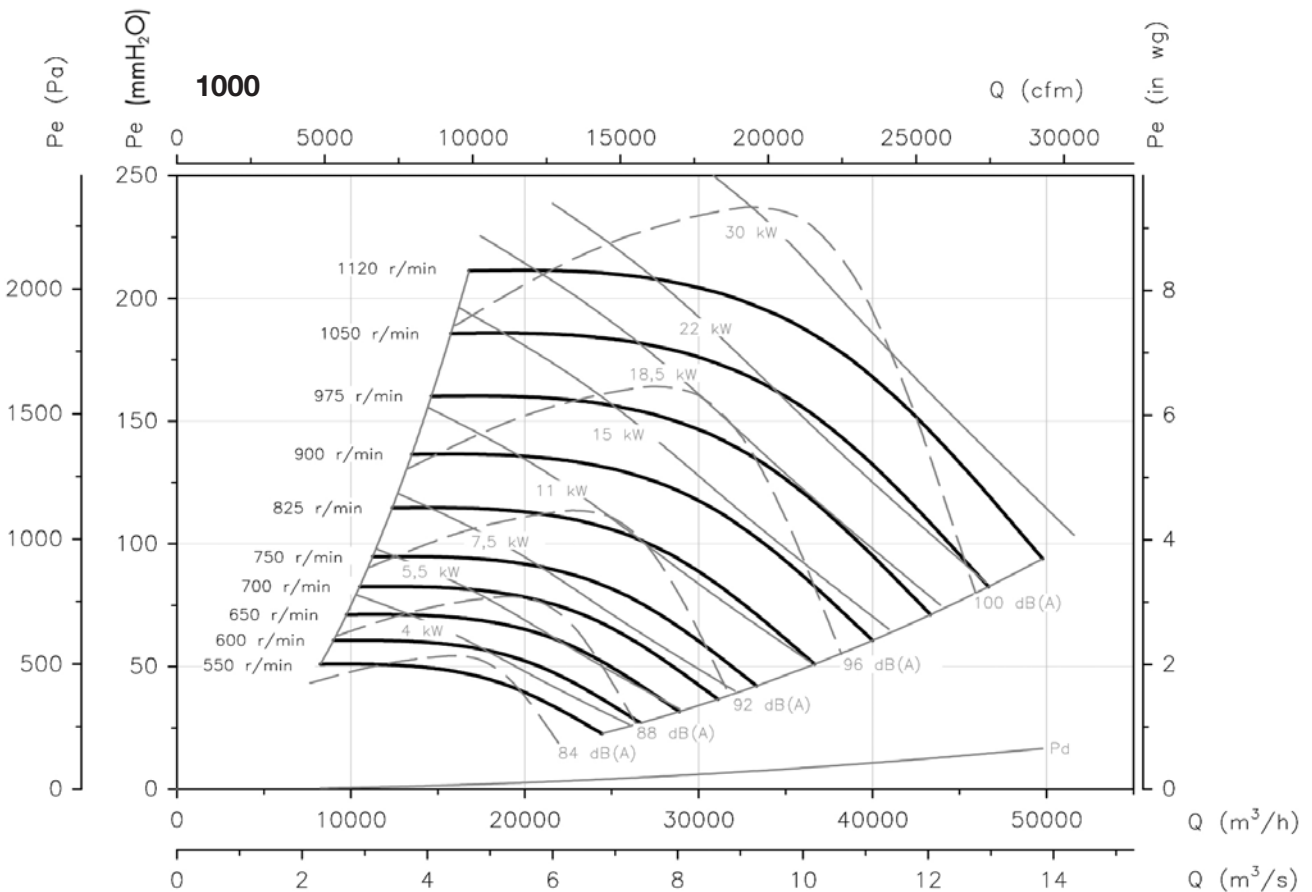
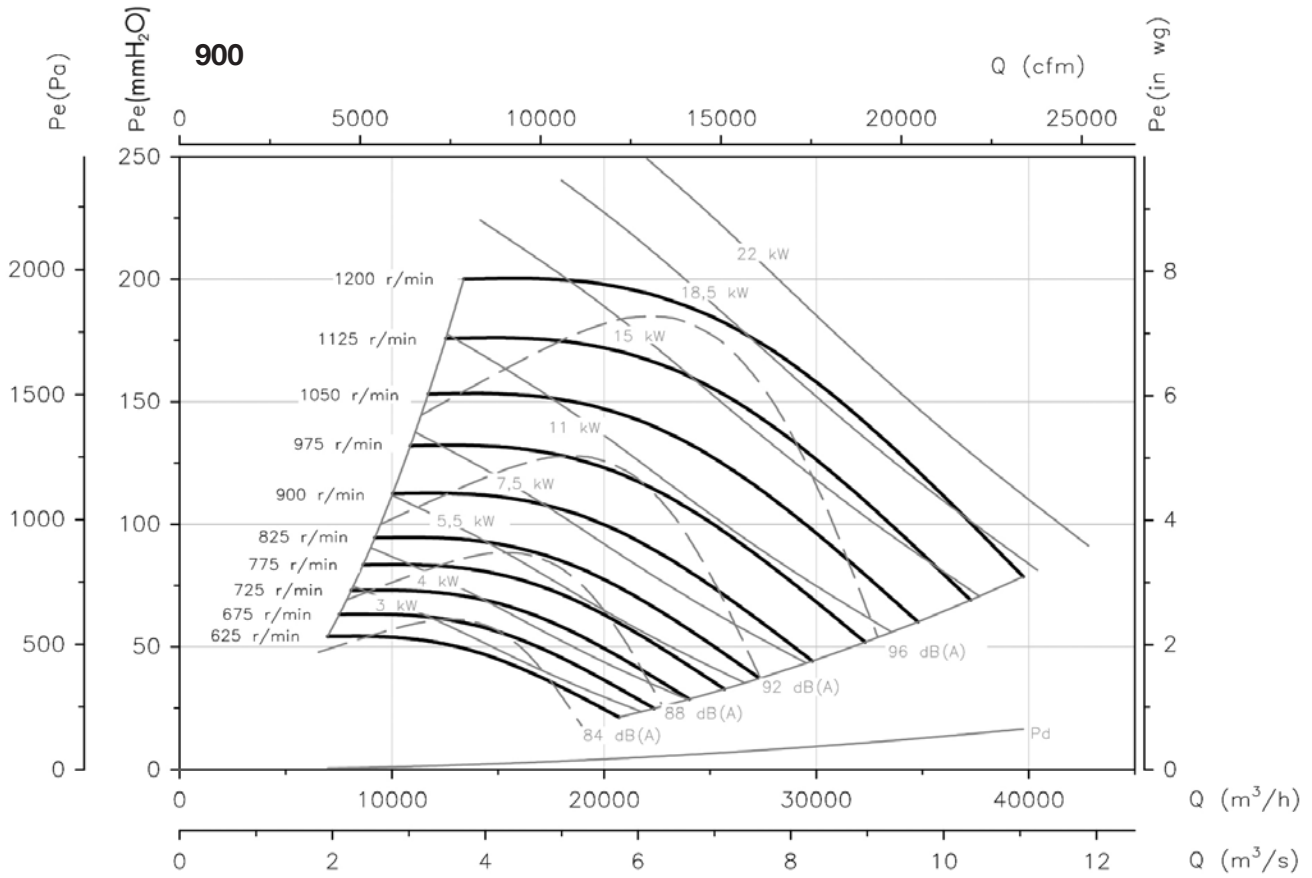

# CBD



High quality, extremely robust impeller, dynamically balanced in accordance with ISO 21940-11

## Double inlet centrifugal fans with direct drive motors and forward-curved impeller

### Fan:

- Galvanised sheet steel casing.
- Forward-curved impeller made of galvanised sheet steel.
- Supplied with PSB support feet.

### Motor:

- High efficiency (HE) motors in compliance with ErP 2015.
- Closed motors with built-in thermal protector, class F, with ball bearings, IP54 protection.
- Multi voltage motor, special design valid for 220/380V 60Hz, 254/440V 60Hz, 265/460V 60Hz, 277/480V 60Hz.
- Maximum temperature of air to be carried: -20 °C + 60 °C.

### Finish:

- Anti-corrosive finished galvanised sheet steel.

## Order code

**CBD** — **2525** — **4M** — **3/4** — **60Hz**

CBD: Double inlet centrifugal fans with direct drive motors and forward-curved impeller

Impeller size mm  
mm.    inch.  
1919    7/7  
2525    9/9  
2828    10/10  
3333    12/12  
3939    15/15

Number of motor poles  
4=1680 r/min. 60 Hz  
6=1080 r/min. 60 Hz

T=Three-phase  
M=Single-phase

Motor power (hp)

## Technical characteristics

**60Hz**

Model	Maximum speed (r/min)	Equivalent Inches	Maximum admissible current (A)		Installed power (kW)	Maximum flow rate (m <sup>3</sup> /h)	Sound level dB(A)	Approx. weight (kg)
			220-277V	380-480V				
CBD-1919-4M 1/5/HE	1476	7/7	1.40		0.15	1520	59	7
CBD-1919-6M 1/10/HE	984	7	7	0.85	0.07	1230	53	7
CBD-2525-4M 1/2/HE	1584	9/9	3.30		0.37	2800	66	13.2
CBD-2525-4M 3/4/HE	1572	9/9	4.50		0.55	3600	70	14
CBD-2525-6M 1/5/HE	1020	9	9	1.50	0.15	2200	60	11.5
CBD-2525-6M 1/3/HE	996	9	9	2.20	0.25	2700	62	12.7
CBD-2828-4M 1/2/HE	1584	10/10	3.30		0.37	2800	65	15.7
CBD-2828-4M 3/4/HE	1572	10/10	4.50		0.55	3950	70	16.5
CBD-2828-6M 1/3/HE	996	10	10	2.20	0.25	3200	62	15.2
CBD-2828-6M 3/4/HE	1080	10	10	4.50	0.55	3600	64	21
CBD-3333-6T 1 1/2/HE	1080	12/12	6.60	3.80	1.1	7800	75	24.5
CBD-3333-6M 3/4/HE	1020	12	12	5.00	0.55	4900	64	23
CBD-3333-6M 1/HE	1020	12	12	6.00	0.75	6000	71	24
CBD-3939-6T 3/HE	1068	15/15	10.90	6.30	2.2	11900	75	39



Acoustic characteristics

Sound power spectrum Lw(A) in dB(A) per Hz frequency band Maximum speed:

Model	63	125	250	500	1000	2000	4000	8000	Model	63	125	250	500	1000	2000	4000	8000
CBD-1919-4M 1/5/HE	29	44	55	63	65	64	63	55	CBD-2828-4M 3/4/HE	40	55	66	74	76	75	74	66
CBD-1919-6M 1/10/HE	23	38	49	57	59	58	57	49	CBD-2828-6M 1/3/HE	32	47	58	66	68	67	66	58
CBD-2525-4M 1/2/HE	36	51	62	70	72	71	70	62	CBD-2828-6M 3/4/HE	34	48	60	68	70	69	67	60
CBD-2525-4M 3/4/HE	40	55	66	74	76	75	74	66	CBD-3333-6T 1 1/2/HE	45	60	71	79	81	80	79	71
CBD-2525-6M 1/5/HE	30	45	56	64	66	65	64	56	CBD-3333-6M 3/4/HE	34	49	60	68	70	69	68	60
CBD-2525-6M 1/3/HE	32	47	58	66	68	67	66	58	CBD-3333-6M 1/HE	41	56	67	75	77	76	75	67
CBD-2828-4M 1/2/HE	35	50	61	69	71	70	69	61	CBD-3939-6T 3/HE	48	62	74	81	84	83	81	73

Dimensions mm

CBD- 1919...3333

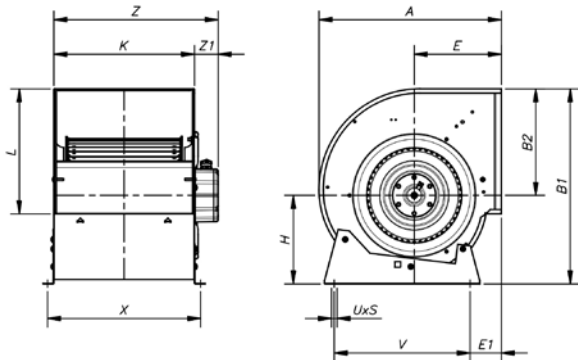

CBD- 3939

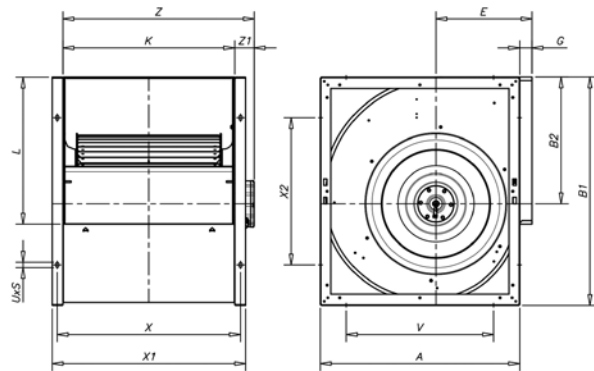

Model	Equiv. Plug.	A	B1	B2	E	E1	G	H	K	L	UxS	V	X	x1	x2	Z1	Z
CBD-1919	7/7	315	333	189	152	64	-	144	230	208	9x13	225	258	-	-	70	300
CBD-2525	9/9	380	400	218	183	78	-	182	300	263	9x13	275	328	-	-	57	357
CBD-2828	10/10	422	450	246	202	73	-	204	326	292	9x13	315	352	-	-	45	371
CBD-3333	12/12	493	526	290	230	82	-	236	387	345	18x9	390	415	-	-	70	457
CBD-3939	15/15	553	632	352	265	-	30	-	473	408	18x9	406	505	533	406	60	533

Accessories



**Characteristic curves**

Q= Flow rate in m<sup>3</sup>/h, m<sup>3</sup>/s and cfm.

Pe= Static pressure in mm H<sub>2</sub>O, Pa and inwg.

**1919**

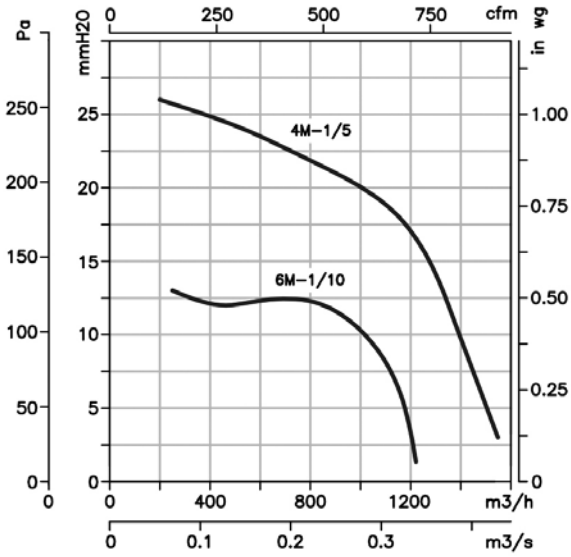

**2525**

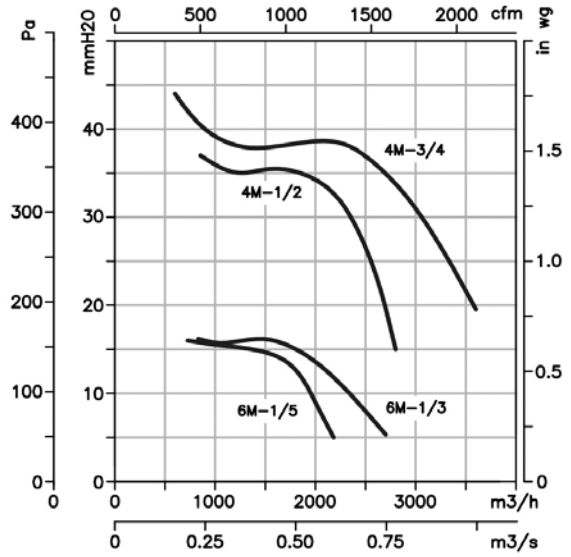

**2828**

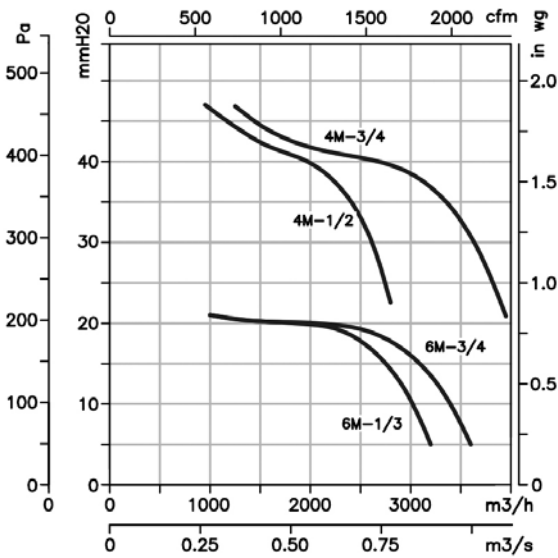

**3333/3939**

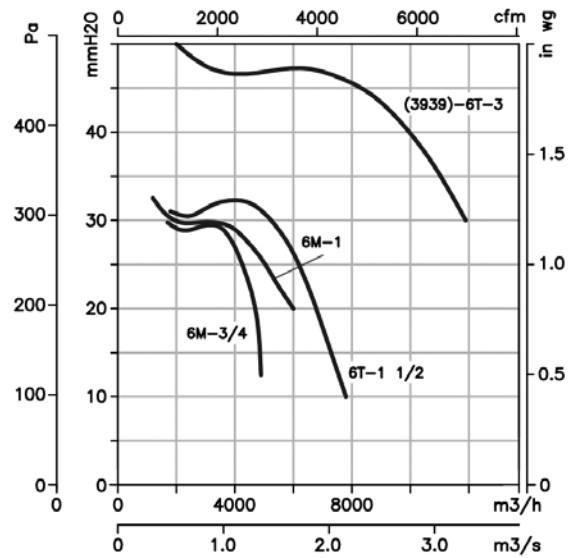

# CJBD/ALG

Ventilation units made of aluminium profiles and galvanised sheet steel with acoustic insulation



**Fan:**

- Double inlet CBD series fans.
- Aluminium profile and galvanised sheet steel structure with thermal and acoustic insulation.
- Forward-curved impeller, made of galvanised sheet steel.
- Cable gland for cable entry.

**Motor:**

- Closed motors with built-in thermal protector, class F, with ball bearings, IP54 protection.
- Multi voltage motor, special design valid for 220/380V 60Hz, 254/440V 60Hz, 265/460V 60Hz, 277/480V 60Hz.
- Maximum temperature of air to be carried: -20 °C + 60 °C.

**Finish:**

- Anti-corrosive finished sheet steel and aluminium profiles.

**On request:**

- With circular impulsion.

**Order code**



**CJBD/ALG:** With aluminium profiles and a galvanised sheet steel casing.  
**CJBD/INT:** Ventilation units with a built-in switch  
**CJBD/C:** Ventilation units with a circular inlet and outlet  
**CJBD/F:** Ventilation units with a built-in filter  
**CJBD/ALS:** Ventilation units with a double insulated wall and pre-varnished sheet steel  
**CJBD/ALF:** Ventilation units with a pre-varnished sheet steel and built-in filter.

Impeller size mm	
mm.	inch.
1919	7/7
2525	9/9
2828	10/10
3333	12/12
3939	15/15

**Number of motor poles**  
 4=1680 r/min. 60 Hz  
 6=1080 r/min. 60 Hz

T=Three-phase  
 M=Single-phase

**Motor power (hp)**

**Options**



CJBD/INT



CJBD/C



CJBD/F



CJBD/ALS



CJBD/ALF

### Technical characteristics

Model	Speed (r/min)	Maximum admissible current (A)		Installed power (kW)	Maximum flow rate (m <sup>3</sup> /h)	Sound level dB(A)	Approx. weight (kg)
		220-277V	380-480V				
CJBD/ALG 1919-4M 1/5	1476	1.40		0.15	1520	59	22.5
CJBD/ALG 1919-6M 1/10	984	0.85		0.08	1230	53	22.5
CJBD/ALG 2525-4M 1/2	1584	3.30		0.37	2800	66	31.8
CJBD/ALG 2525-4M 3/4	1572	4.50		0.55	3600	70	32.6
CJBD/ALG 2525-6M 1/5	1020	1.50		0.15	2200	60	30.1
CJBD/ALG 2525-6M 1/3	996	2.20		0.25	2700	62	31.3
CJBD/ALG 2828-4M 1/2	1584	3.30		0.37	2800	65	37.3
CJBD/ALG 2828-4M 3/4	1572	4.50		0.55	3950	70	38.1
CJBD/ALG 2828-6M 1/3	996	2.20		0.25	3200	62	36.8
CJBD/ALG 3333-6T 1 1/2	1080	6.60	3.80	1.10	7800	75	53.8
CJBD/ALG 3333-6M 3/4	1020	5.00		0.55	4900	64	52.3
CJBD/ALG 3333-6M 1	1020	6.00		0.75	6000	71	53.3
CJBD/ALG 3939-6T 3	1068	10.90	6.30	2.20	11900	75	80.0

### Acoustic characteristics

Sound power spectrum L<sub>w</sub>(A) in dB(A) per Hz frequency band

Model	63	125	250	500	1000	2000	4000	8000	Model	63	125	250	500	1000	2000	4000	8000
1919-4M 1/5	43	54	58	62	64	63	62	53	2828-4M 3/4	55	66	70	74	76	75	74	65
1919-6M 1/10	38	49	53	57	59	58	57	48	2828-6M 1/3	46	57	61	65	67	66	65	56
2525-4M 1/2	51	62	66	70	72	71	70	61	3333-6T 1 1/2	59	70	74	78	80	79	78	69
2525-4M 3/4	55	66	70	74	76	75	74	65	3333-6M 3/4	48	59	63	67	69	68	67	58
2525-6M 1/5	44	55	59	63	65	64	63	54	3333-6M 1	55	66	70	74	76	75	74	65
2525-6M 1/3	46	57	61	65	67	66	65	56	3939-6T 3	61	72	77	81	83	81	80	71
2828-4M 1/2	50	61	65	69	71	70	69	60									

### Dimensions mm

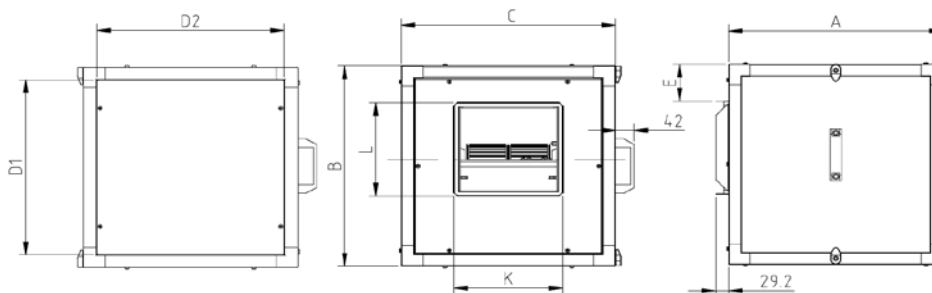

Model	A	B	C	D1	D2	E	L	K
CJBD/ALG-1919	490	490	490	428	428	91	226	247
CJBD/ALG-2525	550	550	550	488	488	86	279	317
CJBD/ALG-2828	605	605	605	543	543	88	306	343
CJBD/ALG-3333	680	680	680	618	618	84	360	404
CJBD/ALG-3939	855	855	855	793	793	119	423	490

**Characteristic curves**

Q= Flow rate in m<sup>3</sup>/h, m<sup>3</sup>/s and cfm.

Pe= Static pressure in mm H<sub>2</sub>O, Pa and inwg.

**1919**

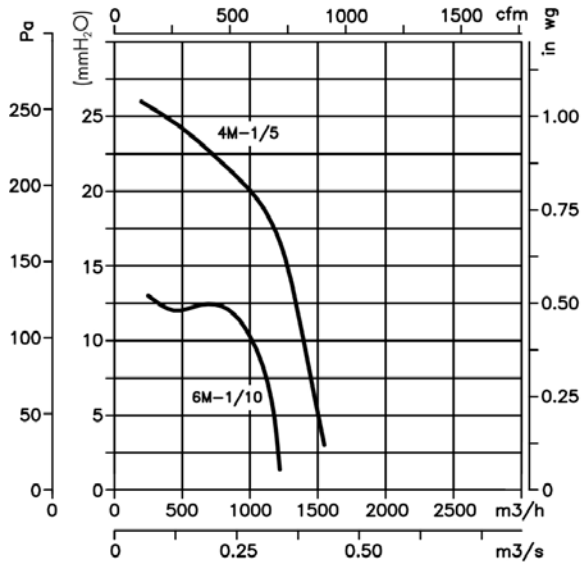

**2525**

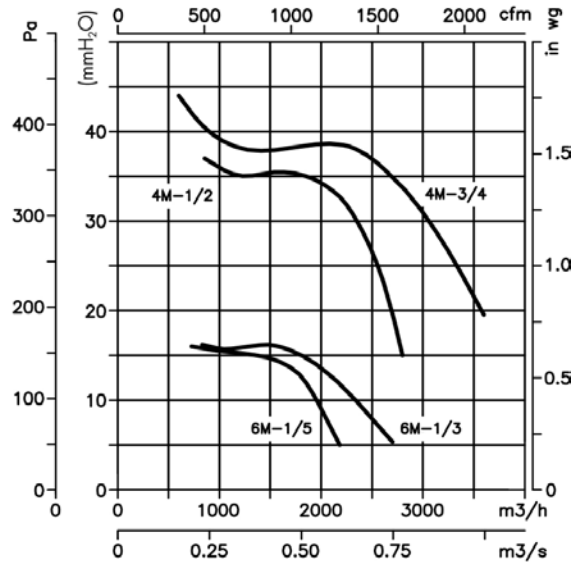

**2828**

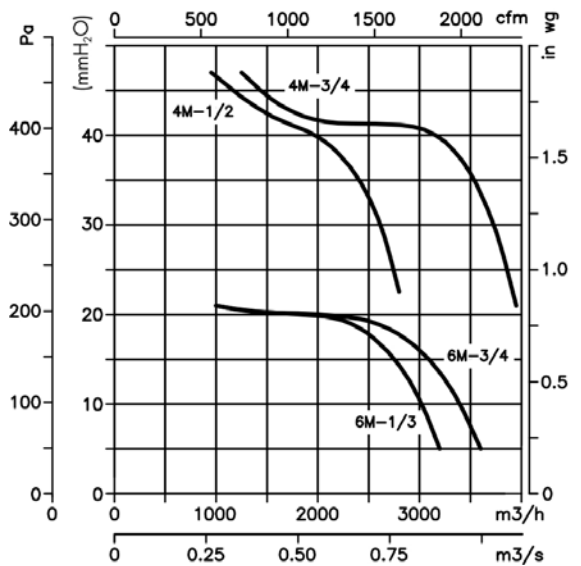

**3333/3939**

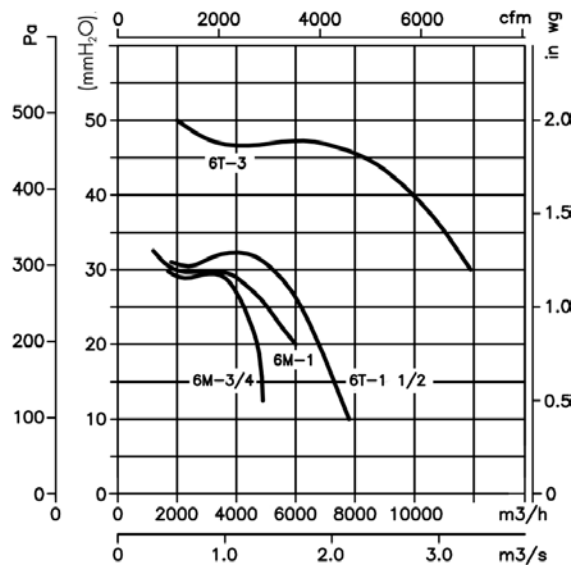

**Accessories**



INT

C2V

RM

VSD3/A-RFT

AET

TEJ

VIS

# CBX CBXC CBXR CBXT

**CBX:** Belt-driven double inlet centrifugal fans with shaft outlet on both sides and forward-curved impeller

**CBXC:** Belt-driven double inlet centrifugal fans with an extremely rigid cube-like structure to reinforce the casing

**CBXR:** Belt-driven double inlet centrifugal fans with a reinforced structure and rigid-bridge bearings resting on the structure

**CBXT:** Belt-driven double inlet centrifugal fans fitted with electric motors, a set of pulleys and belts, protectors and forward-curved impeller



CBX

#### Fan:

- Galvanised sheet steel casing.
- Forward-curved impeller made of galvanised sheet steel.
- CBX and CBXC: Bearings resting on rubber shock-absorbers to prevent vibrations.
- CBX: Supplied with PSB support feet.

#### Motor:

- IE3 efficiency motors for powers equal to or greater than 0.75kW except single-phase, 2-speed and 8-pole.
- Free shaft with permanently-greased ball bearings on both sides.
- Maximum temperature of air to be carried:  
CBX, CBXC and CBXT: -20 °C +80 °C  
CBXR: -20 °C +110 °C.

#### Finish:

- Anti-corrosive finished galvanised sheet steel.

#### On request:

- CBX: The motor support and SM belt tensioner can be supplied.



CBXC



CBXR



CBXT

## Order code

**CBXC — 12/12 — 60Hz**

CBX: Double inlet centrifugal fans with free shaft outlet

Impeller size in inches

CBXC: Double inlet centrifugal fans with a cube-like structure

CBXR: Double inlet centrifugal fans with a reinforced structure

**CBXT — 12/12 — 1.5 — 60Hz**

CBXT: Double inlet, belt-driven centrifugal fans fitted with electric motors

Impeller size in inches

Motor power (hp)

**Technical characteristics**

Model	Max. speed (r/min)	Equivalence Inches	Max. installed power (kW)	Maximum flow rate (m³/h)	Air temperature (°C)		Approx. weight (kg)
					min.	max.	
CBX-1919	2500	7/7	1.1	3700	-20	+80	5.0
CBX-2525	1800	9/9	2.2	6200	-20	+80	9.0
CBX-2828	1700	10/10	3.0	7500	-20	+80	10.5
CBX-3333	1400	12/12	3.0	9500	-20	+80	15.5
CBX-3939	1000	15/15	4.0	14400	-20	+80	24.0
CBX-4747	800	18/18	5.5	23500	-20	+80	33.5
CBXC-7/7	2700		1.5	4200	-20	+80	6.0
CBXC-9/9	2100		3.0	7000	-20	+80	11.5
CBXC-10/10	1900		4.0	8400	-20	+80	13.5
CBXC-12/12	1600		4.0	10500	-20	+80	18.5
CBXC-15/15	1100		5.5	16000	-20	+80	27.5
CBXC-18/18	900		7.5	26000	-20	+80	38.5
CBXR-15/15	1200		5.5	16000	-20	80	28.5
CBXR-18/18	1000		7.5	26000	-20	80	40.0
CBXR-20/20	1000		11.0	28000	-20	+110	84.0
CBXR-22/22	900		15.0	34000	-20	+110	94.0
CBXR-25/25	700		15.0	46000	-20	+110	113.0
CBXR-30/28	600		18.5	60000	-20	+110	145.0

Model	Speed (r/min)	Maximum admissible current (A)			Installed power (kW)	Maximum flow rate (m³/h)	Air temperature (°C)		Approx. weight (kg)	Version Assembly
		220V	380V	660V			min.	max.		
CBXT-7/7-0.25	1090	1.1	0.64		0.18	1050	-20	+80	37.0	A
CBXT-7/7-0.33	1220	1.4	0.78		0.25	1100	-20	+80	37.8	A
CBXT-7/7-0.5	1420	1.8	1.05		0.37	1250	-20	+80	39.0	A
CBXT-7/7-0.75	1600	2.5	1.45		0.55	1450	-20	+80	41.0	A
CBXT-7/7-1	1790	3.3	1.90		0.75	1500	-20	+80	42.5	A
CBXT-9/9-0.25	825	1.1	0.64		0.18	1700	-20	+80	48.0	A
CBXT-9/9-0.33	920	1.4	0.78		0.25	1800	-20	+80	50.0	A
CBXT-9/9-0.5	1020	1.8	1.05		0.37	2200	-20	+80	51.5	A
CBXT-9/9-0.75	1050	2.5	1.45		0.55	2900	-20	+80	54.5	A
CBXT-9/9-1	1070	3.3	1.90		0.75	3200	-20	+80	56.0	A
CBXT-9/9-1.5	1260	4.5	2.59		1.10	3750	-20	+80	59.0	A
CBXT-10/10-0.5	845	1.8	1.05		0.37	2950	-20	+80	55.0	A
CBXT-10/10-0.75	845	2.5	1.45		0.55	3800	-20	+80	57.0	A
CBXT-10/10-1	960	3.3	1.90		0.75	4175	-20	+80	58.5	A
CBXT-10/10-1.5	1070	4.5	2.59		1.10	4800	-20	+80	61.3	A
CBXT-10/10-2	1140	6.0	3.45		1.50	5400	-20	+80	64.6	A
CBXT-12/12-0.5	595	1.8	1.05		0.37	4200	-20	+80	69.0	A
CBXT-12/12-0.75	675	2.5	1.45		0.55	4800	-20	+80	71.0	A
CBXT-12/12-1	765	3.3	1.90		0.75	5400	-20	+80	72.4	A
CBXT-12/12-1.5	855	4.5	2.59		1.10	5800	-20	+80	75.3	A
CBXT-12/12-2	965	6.0	3.45		1.50	6500	-20	+80	78.6	A
CBXT-12/12-3	1180	8.4	4.85		2.20	7400	-20	+80	87.0	A
CBXT-15/15-0.75	525	2.5	1.45		0.55	5900	-20	+80	85.0	B
CBXT-15/15-1	595	3.3	1.90		0.75	6500	-20	+80	86.4	B
CBXT-15/15-1.5	635	4.5	2.59		1.10	7500	-20	+80	89.3	B
CBXT-15/15-2	670	6.0	3.45		1.50	8200	-20	+80	92.6	B
CBXT-15/15-3	740	8.4	4.85		2.20	9500	-20	+80	101.0	B
CBXT-15/15-4	805	11.2	6.48		3.00	10600	-20	+80	103.0	B
CBXT-15/15-5.5	965	15.0	8.65		4.00	12000	-20	+80	108.0	B
CBXT-18/18-1.5	480	4.5	2.59		1.10	9000	-20	+80	122.0	B
CBXT-18/18-2	605	6.0	3.45		1.50	9250	-20	+80	125.3	B
CBXT-18/18-3	590	8.4	4.85		2.20	11500	-20	+80	133.7	B
CBXT-18/18-4	640	11.2	6.48		3.00	13200	-20	+80	135.7	B
CBXT-18/18-5.5	675	15.0	8.65		4.00	15000	-20	+80	141.0	B
CBXT-18/18-7.5	760		11.40	6.60	5.50	17000	-20	+80	154.5	B
CBXT-20/20-2	430	6.0	3.45		1.50	11500	-20	+80	222.0	B
CBXT-20/20-3	530	8.4	4.85		2.20	12800	-20	+80	230.5	B
CBXT-20/20-4	575	11.2	6.48		3.00	14200	-20	+80	232.5	B
CBXT-20/20-5.5	635	15.0	8.65		4.00	15500	-20	+80	237.5	B
CBXT-20/20-7.5	675		11.40	6.60	5.50	17500	-20	+80	251.5	B
CBXT-20/20-10	725		14.80	8.50	7.50	20000	-20	+80	266.5	B
CBXT-22/22-2	385	6.0	3.45		1.50	14000	-20	+80	250.0	B
CBXT-22/22-3	475	8.4	4.85		2.20	15000	-20	+80	257.0	B

## Technical characteristics

Model	Speed (r/min)	Maximum admis- sible current (A)			Installed power (kW)	Maximum flow rate (m <sup>3</sup> /h)	Air temperature (°C)		Approx. weight (kg)	Version Assembly
		220V	380V	660V			min.	max.		
CBXT-22/22-4	515	11.2	6.48		3.00	17000	-20	+80	261.0	B
CBXT-22/22-5.5	570	15.0	8.65		4.00	19000	-20	+80	265.0	B
CBXT-22/22-7.5	605		11.40	6.60	5.50	21500	-20	+80	279.0	B
CBXT-22/22-10	725		14.80	8.50	7.50	22000	-20	+80	290.0	B
CBXT-22/22-15	765		21.00	12.10	11.00	27000	-20	+80	316.0	B
CBXT-25/25-3	375	8.4	4.85		2.20	17000	-20	+80	297.0	B
CBXT-25/25-4	405	11.2	6.48		3.00	20500	-20	+80	299.0	B
CBXT-25/25-5.5	450	15.0	8.65		4.00	22000	-20	+80	304.0	B
CBXT-25/25-7.5	485		11.40	6.60	5.50	24500	-20	+80	318.0	B
CBXT-25/25-10	545		14.80	8.50	7.50	28000	-20	+80	329.0	B
CBXT-25/25-15	610		21.00	12.10	11.00	32000	-20	+80	349.0	B
CBXT-30/28-3	330	8.4	4.85		2.20	20000	-20	+80	380.0	B
CBXT-30/28-4	360	11.2	6.48		3.00	22000	-20	+80	382.0	B
CBXT-30/28-5.5	380	15.0	8.65		4.00	25000	-20	+80	387.0	B
CBXT-30/28-7.5	380		11.40	6.60	5.50	31500	-20	+80	402.0	B
CBXT-30/28-10	410		14.80	8.50	7.50	36000	-20	+80	415.0	B
CBXT-30/28-15	430		21.00	12.10	11.00	42000	-20	+80	426.0	B
CBXT-30/28-20	480		28.50	16.50	15.00	48000	-20	+80	449.0	B

## Dimensions mm

## CBX

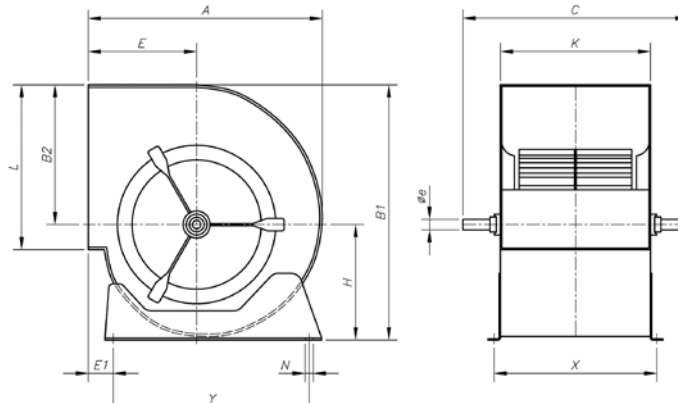

Model	Equiv. inch.	A	B1	B2	C	E	E1	H	K	L	N	øe	X	Y
CBX-1919	7/7	316	333	189	360	152	64	144	230	208	9x13	20	258	225
CBX-2525	9/9	380	400	218	430	183	78	182	300	263	9x13	20	328	275
CBX-2828	10/10	422	450	246	470	202	73	204	326	292	9x17	20	355	315
CBX-3333	12/12	493	526	290	560	230	82	236	387	345	9x17	25	415	390
CBX-3939	15/15	579	621	348	650	265	92	273	473	404	9x17	25	500	455
CBX-4747	18/18	686	746	415	750	323	82	331	540	482	9x17	25	568	575

## CBXC

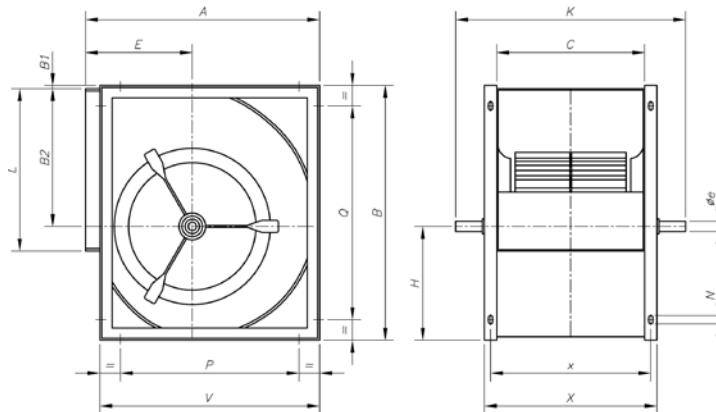

Model	A	B	B2	C	E	øe	H	K	L	N	P	Q	V	X	x
CBXC-7/7	322	342	189	230	152	20	153	360	208	9x17	148	175	292	290	262
CBXC-9/9	388	402	218	300	183	20	184	430	263	9x17	214	214	358	360	332
CBXC-10/10	428	450	246	326	202	20	204	470	292	9x17	254	254	398	386	358
CBXC-12/12	498	532	290	387	230	25	242	560	345	9x17	324	324	468	447	419
CBXC-15/15	583	632	348	473	265	25	284	650	404	9x17	406	406	553	533	505
CBXC-18/18	694	756	415	540	323	25	341	750	482	9x17	520	608	664	600	572



Dimensions mm

CBXR

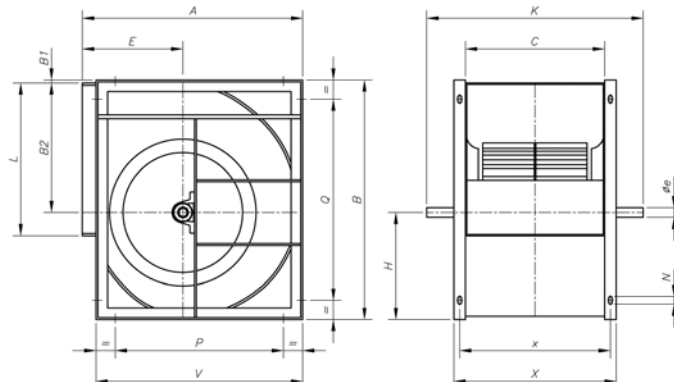

Model	A	B	B1	B2	C	E	øe	H	K	L	N	P	Q	V	X	x
CBXR-15/15	583	632	-	348	473	265	25	284	730	404	9x17	406	406	553	533	505
CBXR-18/18	694	756	-	415	540	323	25	341	800	482	9x17	520	608	664	600	572
CBXR-20/20	843	963	35	523	603	375	35	405	923	603	13x25	646	811	798	683	643
CBXR-22/22	913	1046	35	569	656	400	35	442	976	693	13x25	716	894	868	736	696
CBXR-25/25	998	1161	35	642	765	423	35	484	1085	793	13x25	801	1009	953	845	805
CBXR-30/28	1206	1400	35	776	888	515	40	589	1208	933	13x25	1009	1248	1161	968	928

CBXT  
Assembly A

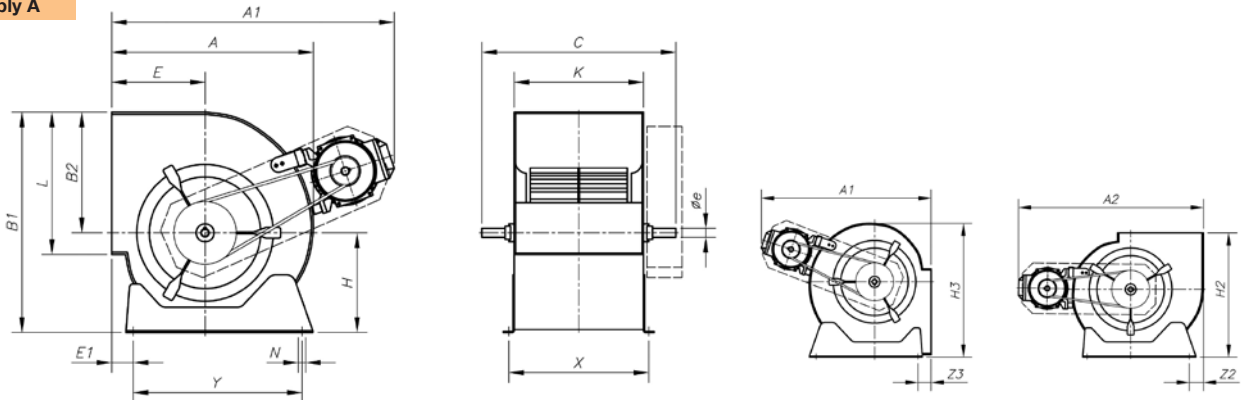

Model	A	A1	A2	B1	B2	C	E	E1	øe	H	H2	H3	K	L	N	X	Y	Z2	Z3
CBXT-7/7-0.25	316	430	475	333	189	360	152	64	20	144	320	341	230	208	9x13	258	225	44	36
CBXT-7/7-0.33	316	450	495	333	189	360	152	64	20	144	320	341	230	208	9x13	258	225	44	36
CBXT-7/7-0.5	316	450	495	333	189	360	152	64	20	144	320	341	230	208	9x13	258	225	44	36
CBXT-7/7-0.75	316	470	515	333	189	360	152	64	20	144	320	341	230	208	9x13	258	225	44	36
CBXT-7/7-1	316	470	515	333	189	360	152	64	20	144	320	341	230	208	9x13	258	225	44	36
CBXT-9/9-0.25	380	490	535	400	218	430	183	78	20	182	385	395	300	263	9x13	328	275	50	57
CBXT-9/9-0.33	380	520	565	400	218	430	183	78	20	182	385	395	300	263	9x13	328	275	50	57
CBXT-9/9-0.5	380	520	565	400	218	430	183	78	20	182	385	395	300	263	9x13	328	275	50	57
CBXT-9/9-0.75	380	540	585	400	218	430	183	78	20	182	385	395	300	263	9x13	328	275	50	57
CBXT-9/9-1	380	540	585	400	218	430	183	78	20	182	385	395	300	263	9x13	328	275	50	57
CBXT-9/9-1.5	380	590	605	400	218	430	183	78	20	182	385	395	300	263	9x13	328	275	50	57
CBXT-10/10-0.5	422	570	615	450	246	470	202	73	20	204	443	470	326	292	9x17	355	315	50	50
CBXT-10/10-0.75	422	590	635	450	246	470	202	73	20	204	443	470	326	292	9x17	355	315	50	50
CBXT-10/10-1	422	590	635	450	246	470	202	73	20	204	443	470	326	292	9x17	355	315	50	50
CBXT-10/10-1.5	422	610	655	450	246	470	202	73	20	204	443	470	326	292	9x17	355	315	50	50
CBXT-10/10-2	422	610	655	450	246	470	202	73	20	204	443	470	326	292	9x17	355	315	50	50
CBXT-12/12-0.5	493	645	690	526	290	560	230	82	25	236	498	555	387	345	9x17	415	390	35	70
CBXT-12/12-0.75	493	665	710	526	290	560	230	82	25	236	498	555	387	345	9x17	415	390	35	70
CBXT-12/12-1	493	665	710	526	290	560	230	82	25	236	498	555	387	345	9x17	415	390	35	70
CBXT-12/12-1.5	493	680	725	526	290	560	230	82	25	236	498	555	387	345	9x17	415	390	35	70
CBXT-12/12-2	493	680	725	526	290	560	230	82	25	236	498	555	387	345	9x17	415	390	35	70
CBXT-12/12-3	493	700	745	526	290	560	230	82	25	236	498	555	387	345	9x17	415	390	35	70

Dimensions mm

CBXT  
Assembly B

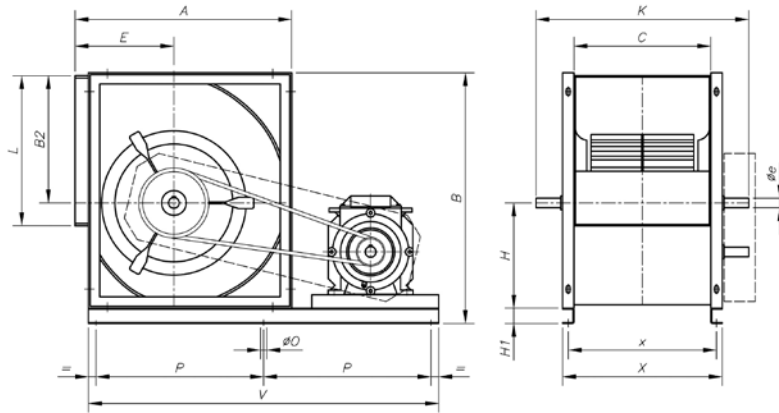

Model	A	B	B2	C	E	øe	H	H1	K	L	ø0	P	V	x	X
CBXT-15/15	583	672	348	473	265	25	284	40	650	404	12	415.5	895	505	533
CBXT-18/18	694	796	415	540	323	25	341	40	750	482	12	515.5	1115	572	600

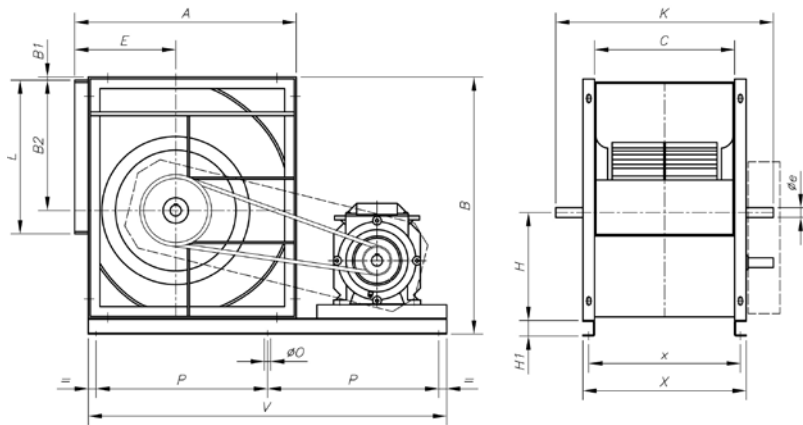

Model	A	B	B1	B2	C	E	øe	H	H1	K	L	ø0	P	V	x	X
CBXT-20/20	843	1023	35	523	603	375	35	405	60	923	603	12	617.5	1315	643	683
CBXT-22/22	913	1106	35	569	656	400	35	442	60	976	693	12	657.5	1395	696	736
CBXT-25/25	998	1221	35	642	765	423	35	484	60	1085	793	12	474.5	1575	805	845
CBXT-30/28	1206	1460	35	776	888	515	40	589	60	1208	933	12	817.5	1715	928	968

Accessories



INT C2V RM VSD3/A-RFT AET PSB SM

**Characteristic curves**

Q= Flow rate in m<sup>3</sup>/h, m<sup>3</sup>/s and cfm.

Pe= Static pressure in mm H<sub>2</sub>O, Pa and inwg.

**7/7 (1919)**

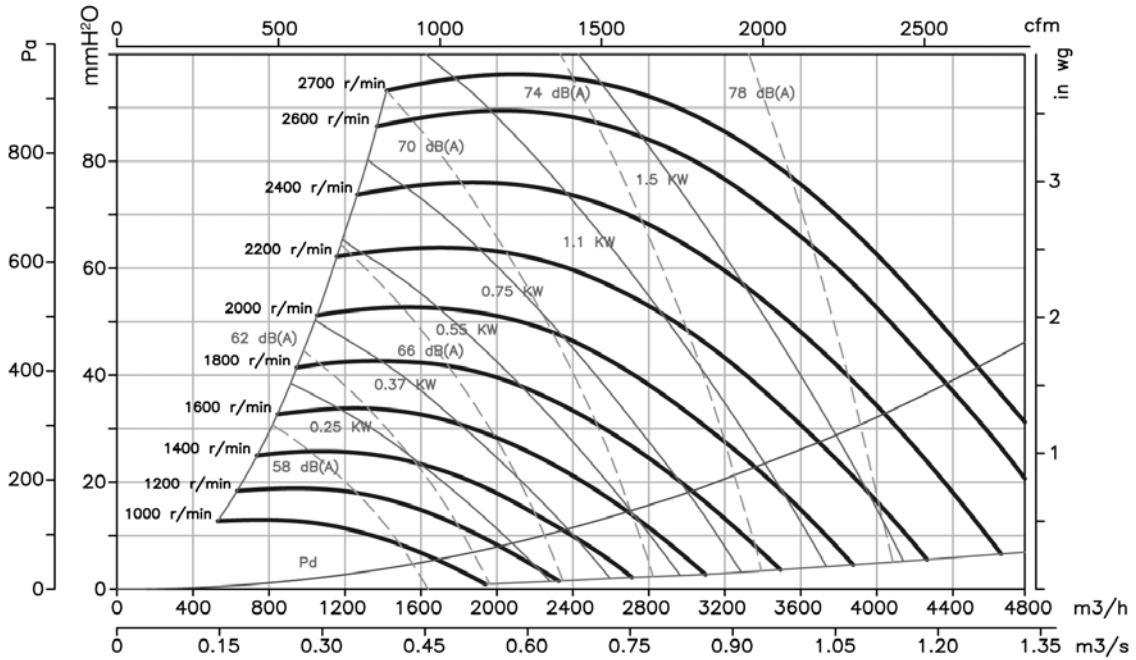

**9/9 (2525)**

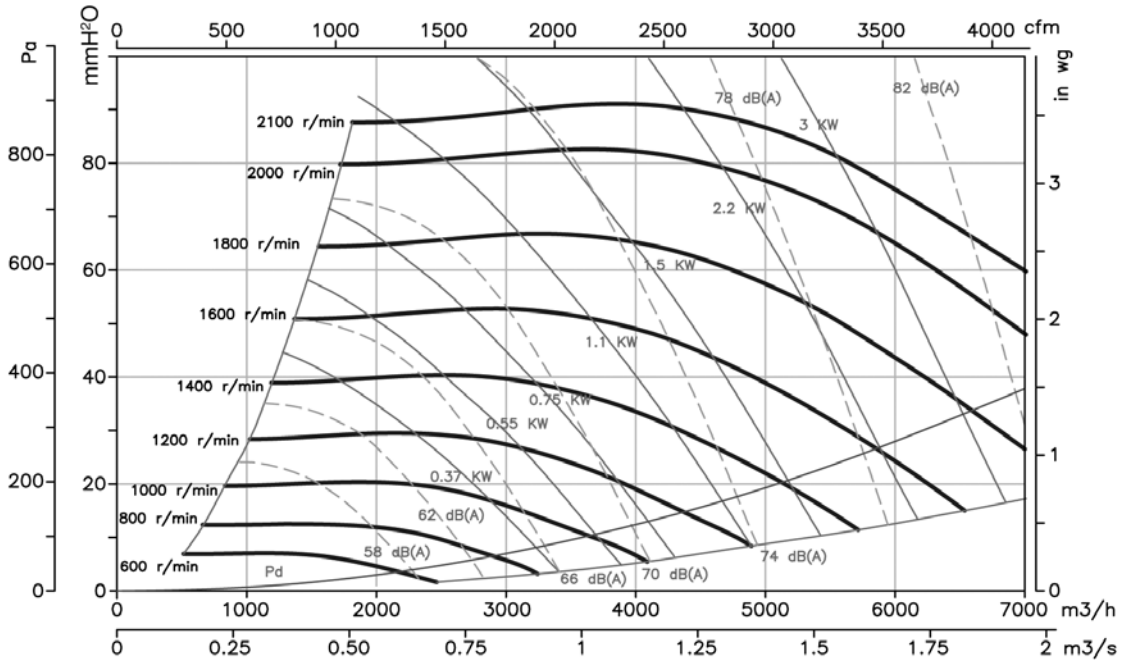

**Characteristic curves**

Q= Flow rate in m<sup>3</sup>/h, m<sup>3</sup>/s and cfm.

Pe= Static pressure in mm H<sub>2</sub>O, Pa and inwg.

**10/10 (2828)**

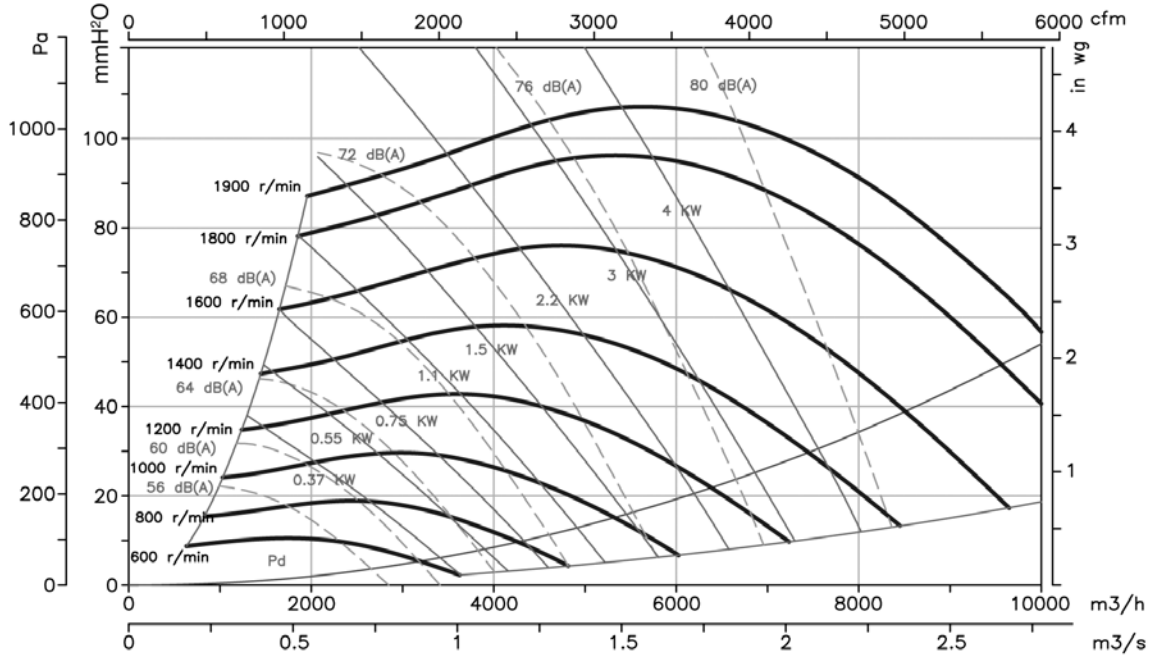

**12/12 (3333)**

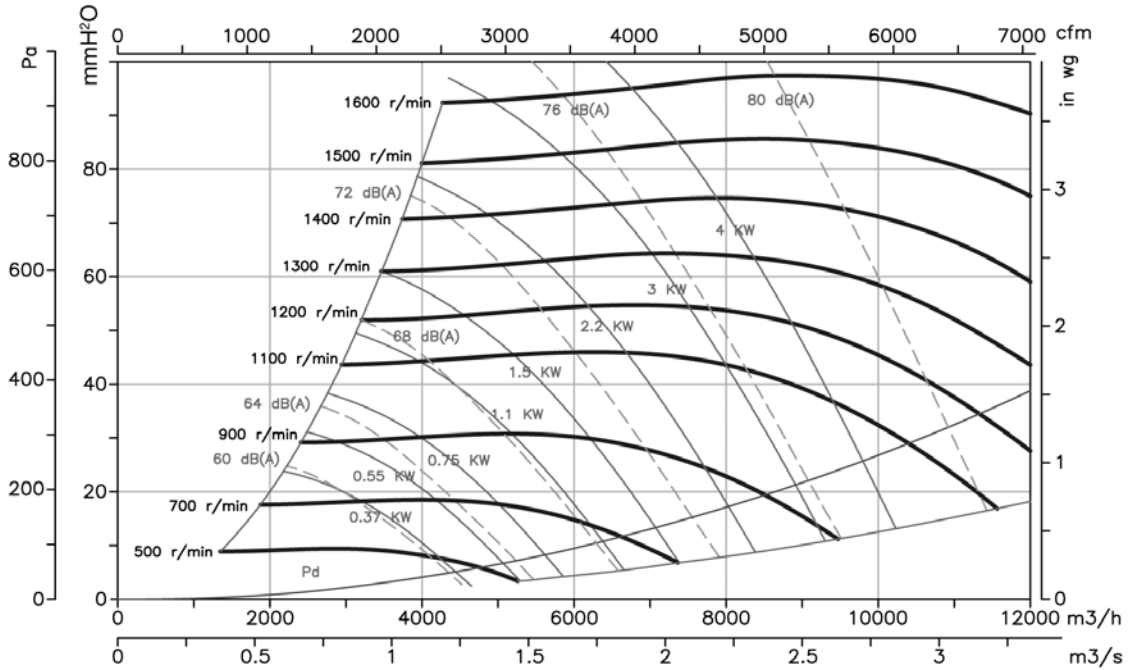

**Characteristic curves**

Q= Flow rate in m<sup>3</sup>/h, m<sup>3</sup>/s and cfm.

Pe= Static pressure in mm H<sub>2</sub>O, Pa and inwg.

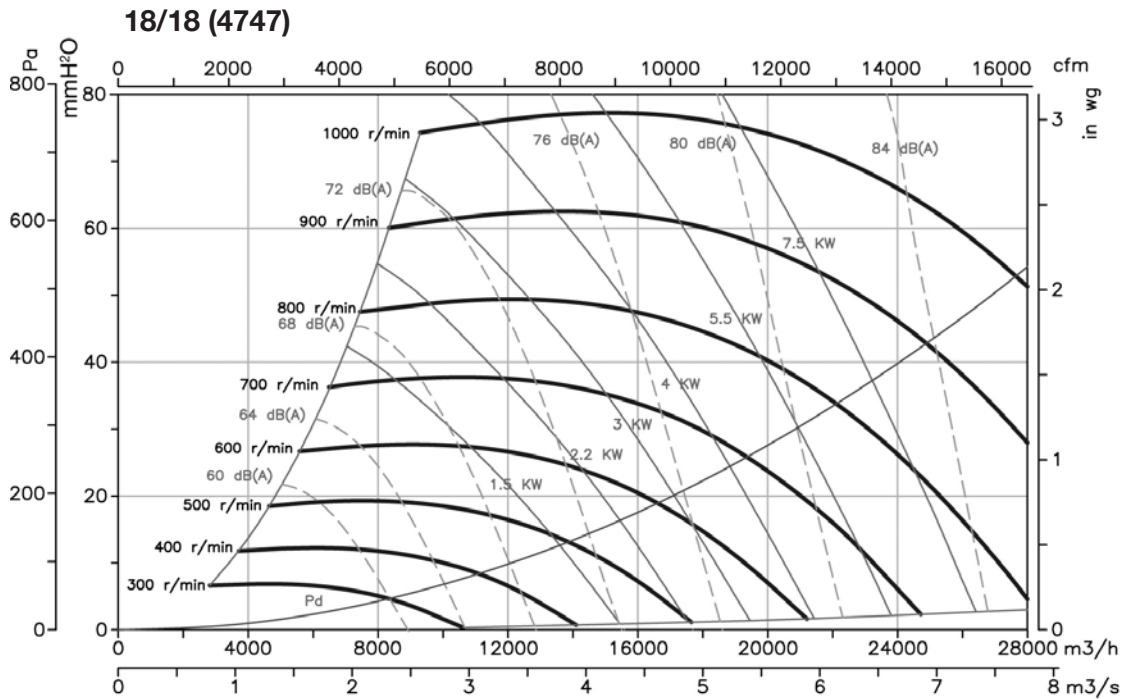
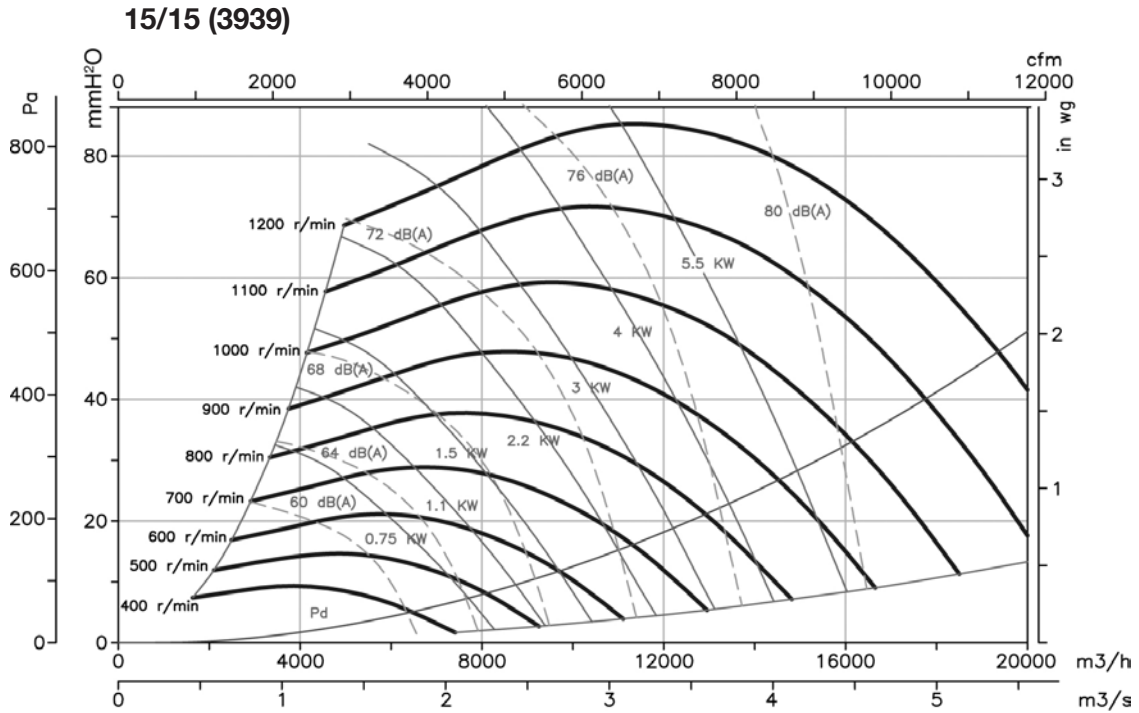

**Characteristic curves**

Q= Flow rate in m<sup>3</sup>/h, m<sup>3</sup>/s and cfm.

Pe= Static pressure in mm H<sub>2</sub>O, Pa and inwg.

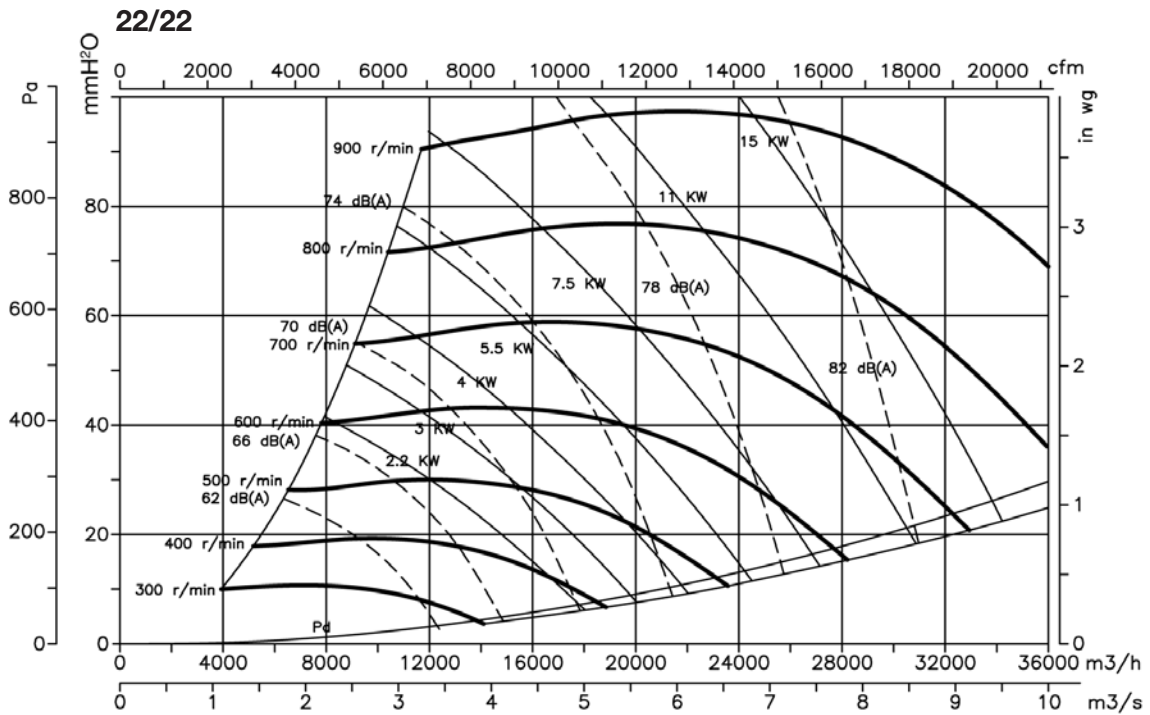
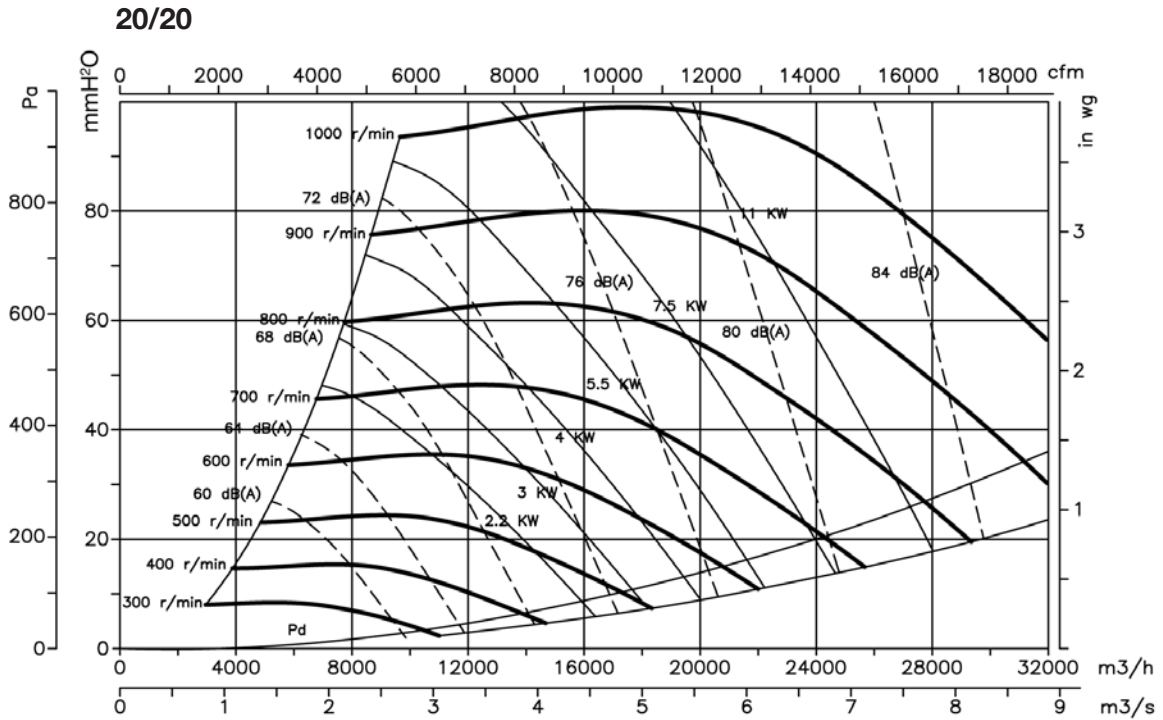

**Characteristic curves**

Q= Flow rate in m<sup>3</sup>/h, m<sup>3</sup>/s and cfm.

Pe= Static pressure in mm H<sub>2</sub>O, Pa and inwg.

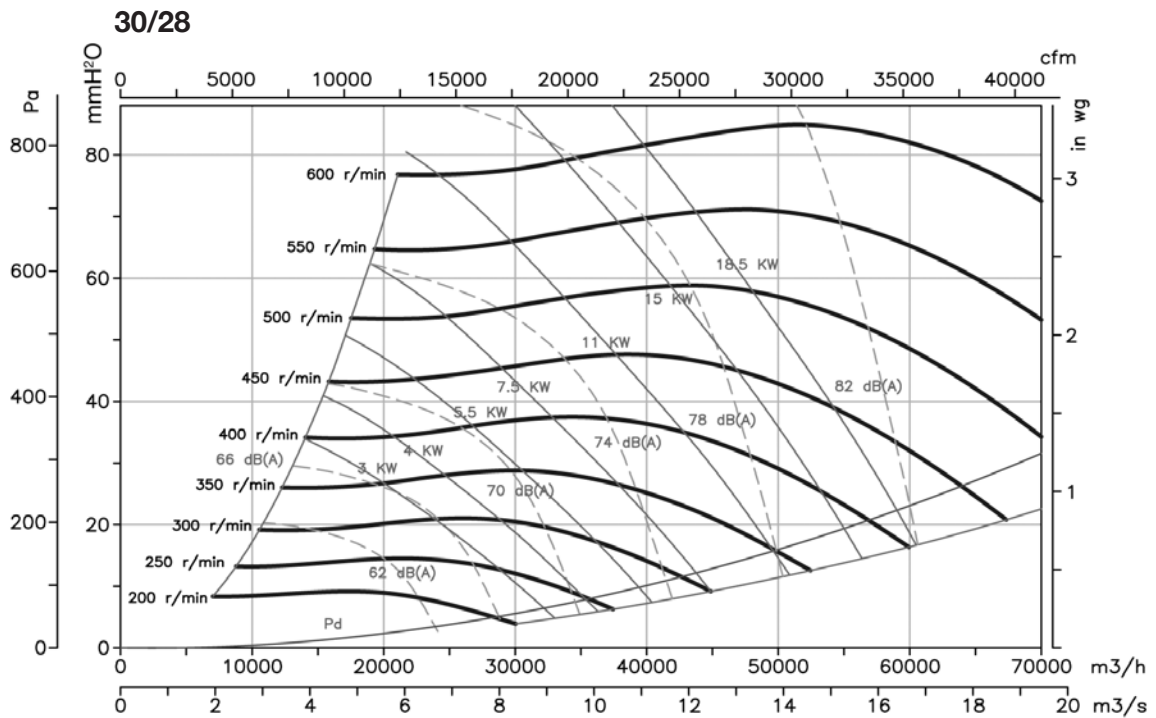
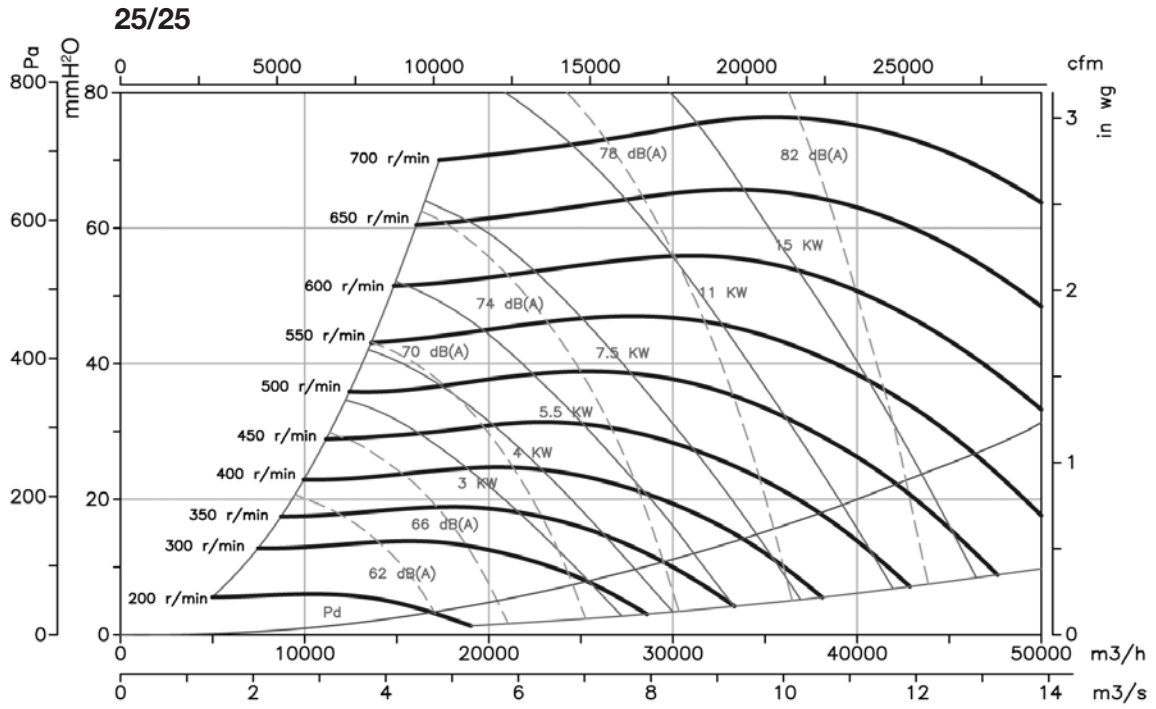

# CJBX/ALG

**Belt-driven ventilation units made of aluminium profiles and galvanised sheet steel with acoustic insulation**



#### Fan:

- Ventilation units fitted with double inlet fans from the CBX, CBXC and CBXR series.
- Aluminium profile and galvanised sheet steel structure with thermal and acoustic insulation.
- Forward-curved impeller made of galvanised sheet steel.
- Cable gland for cable entry.

#### Motor:

- IE3 efficiency motors for powers equal to or greater than 0.75kW except single-phase, 2-speed and 8-pole.
- Class F motors with ball bearings and IP55 protection.
- Multi voltage motor, special design valid for 220/380V 60Hz, 254/440V 60Hz, 265/460V 60Hz, 277/480V 60Hz.
- Maximum temperature of air to be carried: -20 °C + 60 °C

#### Finish:

- Anti-corrosive finished sheet steel and aluminium profiles.

#### On request:

- With circular impulsion.



*High quality, extremely robust impeller, dynamically balanced in accordance with ISO 21940-11.*

## Order code

**CJBX/ALG — 15/15 — 4 — 60Hz**



CJBX/ALG: With aluminium profiles and a galvanised sheet steel casing

CJBX/F: Ventilation units with a built-in filter

CJBX/ALS: Ventilation units with double insulated wall and pre-varnished sheet steel

CJBX/ALF: Ventilation units with a pre-varnished sheet steel and built-in filter



Impeller size in inches



Motor power (hp)

## Options



CJBX/F

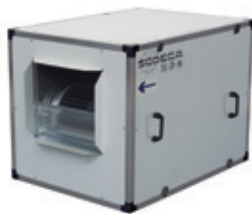

CJBX/ALS



CJBX/ALF



60Hz

## Technical characteristics

Model	Speed (r/min)	Max. admissible current (A)		Installed power (kW)	Maximum flow rate (m <sup>3</sup> /h)	Sound pres- sure level dB(A)	Approx. weight (kg)	Type Assembly
		220-277V	380-480V					
CJBX/ALG 7/7-0.25	1090	1.23	0.71	0.18	1050	48	37.0	A
CJBX/ALG 7/7-0.33	1220	1.66	0.96	0.25	1100	50	37.8	A
CJBX/ALG 7/7-0.5	1420	2.02	1.17	0.37	1250	53	39.0	A
CJBX/ALG 7/7-0.75	1600	2.92	1.69	0.55	1450	56	41.0	A
CJBX/ALG 7/7-1	1790	3.10	1.79	0.75	1500	58	42.5	A
CJBX/ALG 9/9-0.25	825	1.23	0.71	0.18	1700	45	48.0	A
CJBX/ALG 9/9-0.33	920	1.66	0.96	0.25	1800	48	50.0	A
CJBX/ALG 9/9-0.5	1020	2.02	1.17	0.37	2200	51	51.5	A
CJBX/ALG 9/9-0.75	1050	2.92	1.69	0.55	2900	55	54.5	A
CJBX/ALG 9/9-1	1070	3.10	1.79	0.75	3200	56	56.0	A
CJBX/ALG 9/9-1.5	1260	4.03	2.32	1.10	3750	60	59.0	A
CJBX/ALG 10/10-0.5	845	2.02	1.17	0.37	2950	52	55.0	A
CJBX/ALG 10/10-0.75	845	2.92	1.69	0.55	3800	56	57.0	A
CJBX/ALG 10/10-1	960	3.10	1.79	0.75	4175	58	58.5	A
CJBX/ALG 10/10-1.5	1070	4.03	2.32	1.10	4800	61	61.3	A
CJBX/ALG 10/10-2	1140	5.96	3.44	1.50	5400	63	64.6	A
CJBX/ALG 12/12-0.5	595	2.02	1.17	0.37	4200	52	69.0	A
CJBX/ALG 12/12-0.75	675	2.92	1.69	0.55	4800	54	71.0	A
CJBX/ALG 12/12-1	765	3.10	1.79	0.75	5400	57	72.4	A
CJBX/ALG 12/12-1.5	855	4.03	2.32	1.10	5800	59	75.3	A
CJBX/ALG 12/12-2	965	5.96	3.44	1.50	6500	62	78.6	A
CJBX/ALG 12/12-3	1180	8.36	4.83	2.20	7400	65	87.0	A
CJBX/ALG 15/15-0.75	525	2.92	1.69	0.55	5900	49	85.0	B
CJBX/ALG 15/15-1	595	3.10	1.79	0.75	6500	52	86.4	B
CJBX/ALG 15/15-1.5	635	4.03	2.32	1.10	7500	54	89.3	B
CJBX/ALG 15/15-2	670	5.96	3.44	1.50	8200	56	92.6	B
CJBX/ALG 15/15-3	740	8.36	4.83	2.20	9500	59	101.0	B
CJBX/ALG 15/15-4	805	10.96	6.33	3.00	10600	61	103.0	B
CJBX/ALG 15/15-5.5	965	14.10	8.12	4.00	12000	63	108.0	B
CJBX/ALG 18/18-1.5	480	4.03	2.32	1.10	9000	48	122.0	B
CJBX/ALG 18/18-2	605	5.96	3.44	1.50	9250	51	125.3	B
CJBX/ALG 18/18-3	590	8.36	4.83	2.20	11500	54	133.7	B
CJBX/ALG 18/18-4	640	10.96	6.33	3.00	13200	56	135.7	B
CJBX/ALG 18/18-5.5	675	14.10	8.12	4.00	15000	58	141.0	B
CJBX/ALG 18/18-7.5	760		11.60	5.50	17000	60	154.5	C
CJBX/ALG 20/20-2	430	5.96	3.44	1.50	11500	56	222.0	C
CJBX/ALG 20/20-3	530	8.36	4.83	2.20	12800	57	230.5	C
CJBX/ALG 20/20-4	575	10.96	6.33	3.00	14200	58	232.5	C
CJBX/ALG 20/20-5.5	635	14.10	8.12	4.00	15500	61	237.5	C
CJBX/ALG 20/20-7.5	675		11.60	5.50	17500	63	251.5	C
CJBX/ALG 20/20-10 IE3	725		13.90	7.50	20000	65	282.5	C
CJBX/ALG 22/22-2	385	5.96	3.44	1.50	14000	50	250.0	C
CJBX/ALG 22/22-3	475	8.36	4.83	2.20	15000	54	257.0	C
CJBX/ALG 22/22-4	515	10.96	6.33	3.00	17000	55	261.0	C
CJBX/ALG 22/22-5.5	570	14.10	8.12	4.00	19000	57	265.0	C
CJBX/ALG 22/22-7.5	605		11.60	5.50	21500	60	279.0	C
CJBX/ALG 22/22-10 IE3	725		13.90	7.50	22000	63	306.0	C
CJBX/ALG 22/22-15 IE3	765		20.90	11.00	27000	65	341.0	C
CJBX/ALG 25/25-3	375	8.36	4.83	2.20	17000	53	297.0	C
CJBX/ALG 25/25-4	405	10.96	6.33	3.00	20500	55	299.0	C
CJBX/ALG 25/25-5.5	450	14.10	8.12	4.00	22000	57	304.0	C
CJBX/ALG 25/25-7.5	485		11.60	5.50	24500	59	318.0	C
CJBX/ALG 25/25-10 IE3	545		13.90	7.50	28000	61	345.0	C
CJBX/ALG 25/25-15 IE3	610		20.90	11.00	32000	64	374.0	C
CJBX/ALG 30/28-3	330	8.36	4.83	2.20	20000	54	380.0	C
CJBX/ALG 30/28-4	360	10.96	6.33	3.00	22000	56	382.0	C
CJBX/ALG 30/28-5.5	380	14.10	8.12	4.00	25000	59	387.0	C
CJBX/ALG 30/28-7.5	380		11.60	5.50	31500	60	402.0	C
CJBX/ALG 30/28-10 IE3	410		13.90	7.50	36000	63	431.0	C
CJBX/ALG 30/28-15 IE3	430		20.90	11.00	42000	65	451.0	C
CJBX/ALG 30/28-20 IE3	480		27.90	15.00	48000	68	466.0	C

Dimensions mm

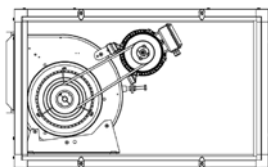
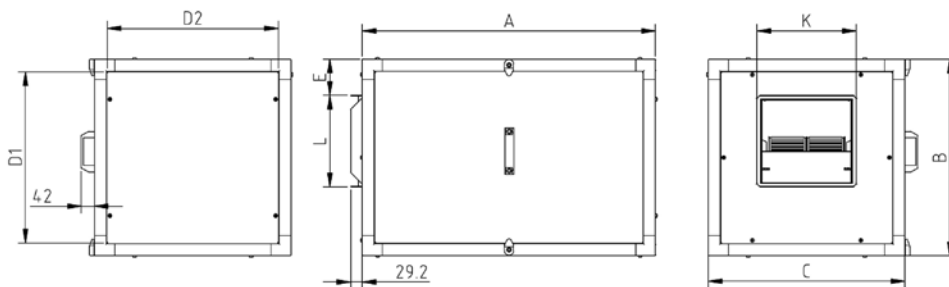

Assembly A

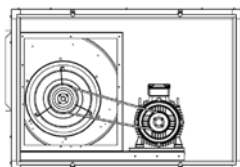

Assembly B

Model	A	B	C	D1	D2	E	L	K	Assembly type
CJBX/ALG-7/7	830	490	490	428	428	91	226	247	A
CJBX/ALG-9/9	920	550	500	488	488	86	279	317	A
CJBX/ALG-10/10	970	605	605	543	543	88	306	343	A
CJBX/ALG-12/12	1050	680	680	618	618	84	360	404	A
CJBX/ALG-15/15	1220	855	855	793	793	119	423	490	B
CJBX/ALG-18/18	1356	1000	1000	938	938	137	498	554	B-C
CJBX/ALG-20/20	1445	1175	1175	1115	1040	136	615	615	C
CJBX/ALG-22/22	1600	1250	1250	1190	1190	124	705	668	C
CJBX/ALG-25/25	1550	1450	1450	1390	1390	198	805	778	C
CJBX/ALG-30/28	1900	1700	1700	1640	1640	224	945	900	C

Vertical impulsion

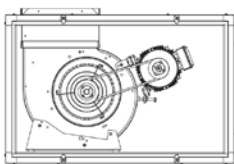
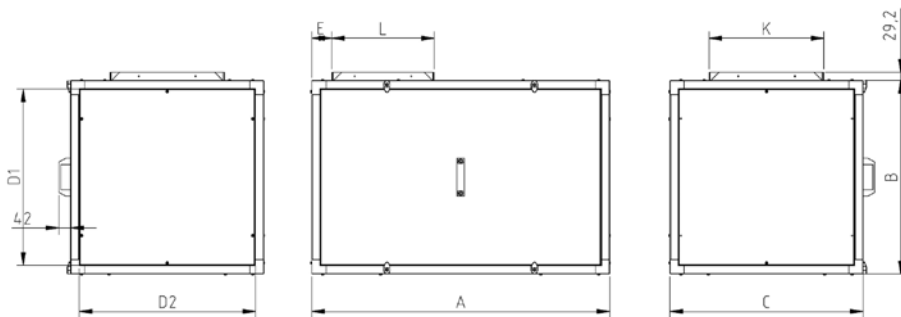

Assembly A

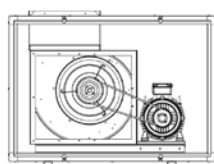

Assembly B

Model	A	B	C	D1	D2	E	L	K	Assembly type
CJBX/ALG-7/7	830	490	490	428	428	63	226	247	A
CJBX/ALG-9/9	920	550	500	488	488	85	279	317	A
CJBX/ALG-10/10	970	605	605	543	543	87	306	343	A
CJBX/ALG-12/12	1050	680	680	618	618	69	360	404	A
CJBX/ALG-15/15	1220	855	855	793	793	115	423	490	B
CJBX/ALG-18/18	1356	1000	1000	938	938	80	498	554	B-C
CJBX/ALG-20/20	1400	1170	1250	1090	1170	349.5	620	618	C
CJBX/ALG-22/22	1480	1230	1300	1150	1220	342.5	711	681	C
CJBX/ALG-25/25	1600	1350	1500	1270	1420	366.5	810	781	C
CJBX/ALG-30/28	1850	1600	1700	1520	1620	459.5	949	906	C

**Characteristic curves**

Q= Flow rate in m<sup>3</sup>/h, m<sup>3</sup>/s and cfm

Pe= Static pressure in mmH<sub>2</sub>O, Pa and inwg.

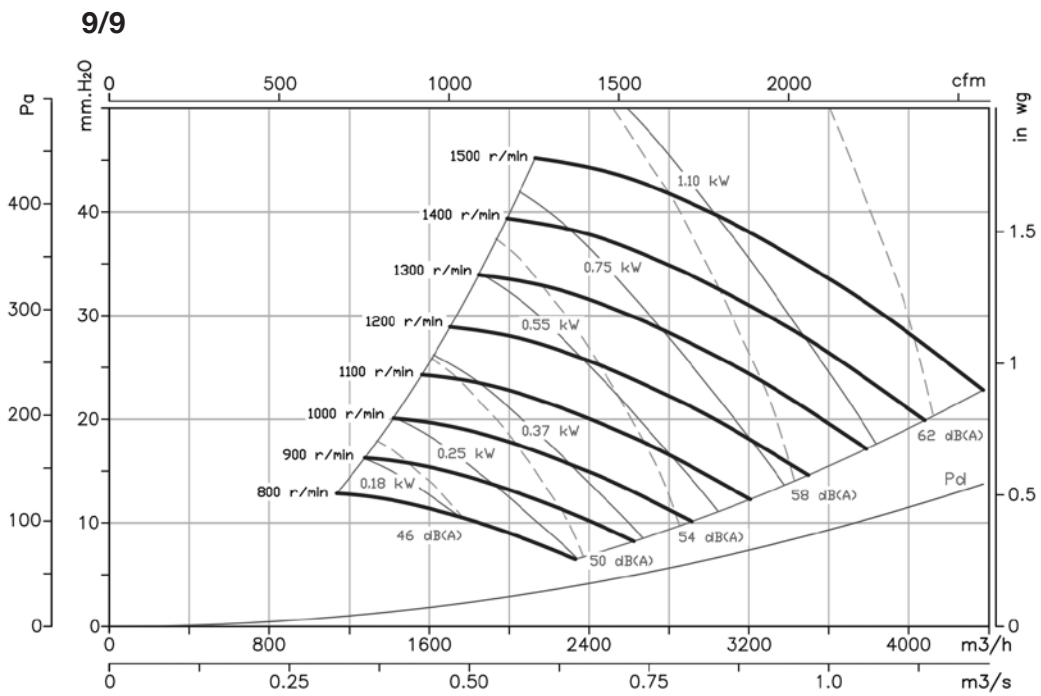
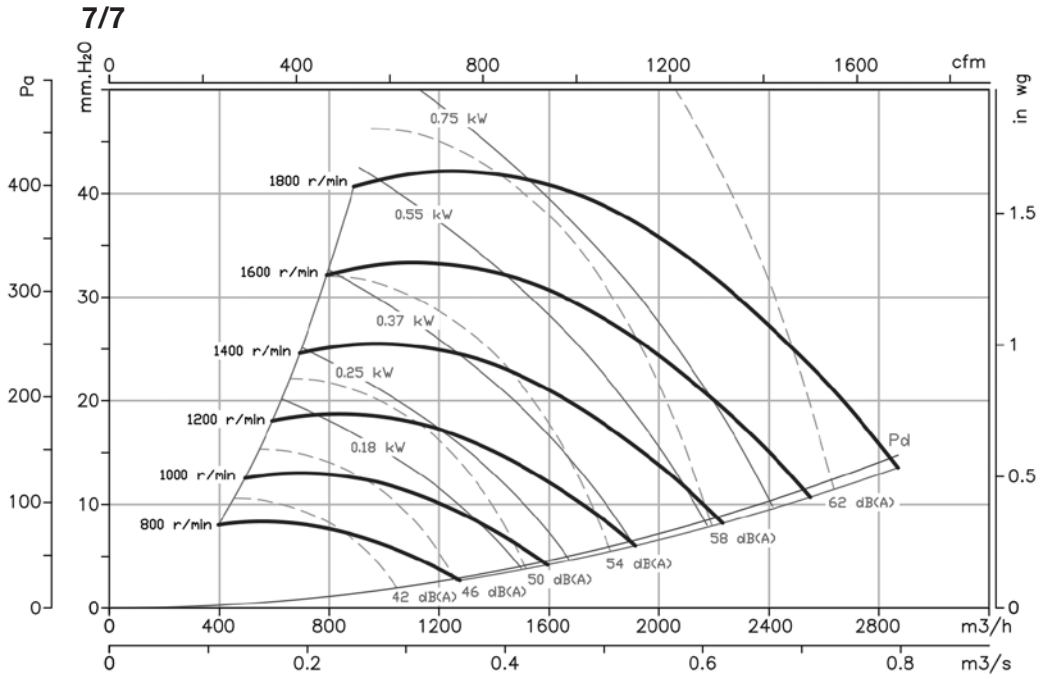

**Characteristic curves**

Q= Flow rate in m<sup>3</sup>/h, m<sup>3</sup>/s and cfm

Pe= Static pressure in mmH<sub>2</sub>O, Pa and inwg.

**10/10**

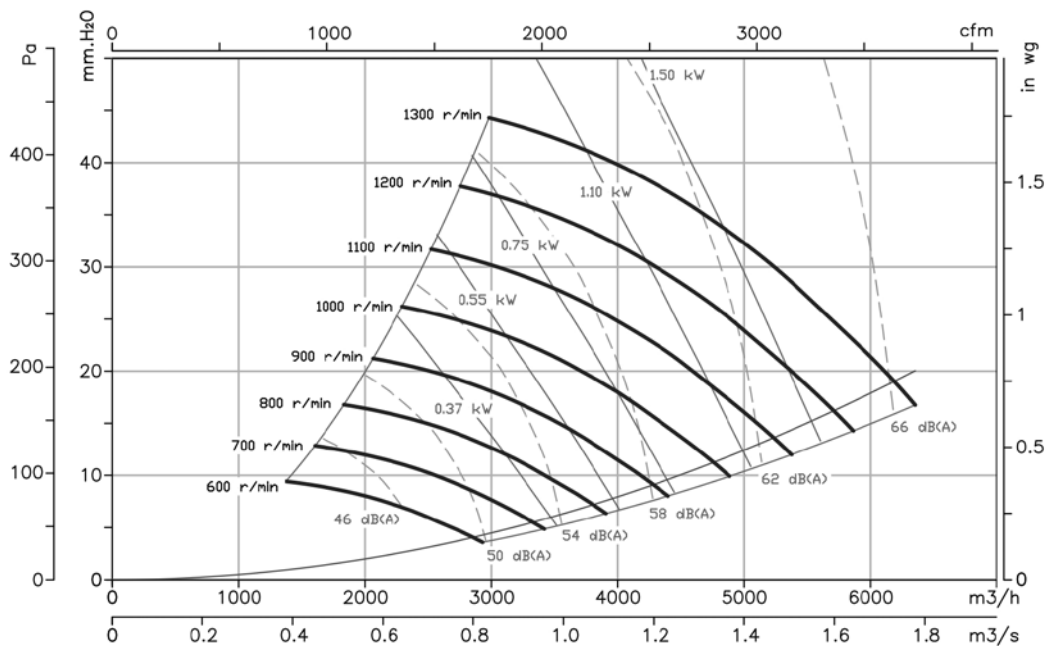

**12/12**

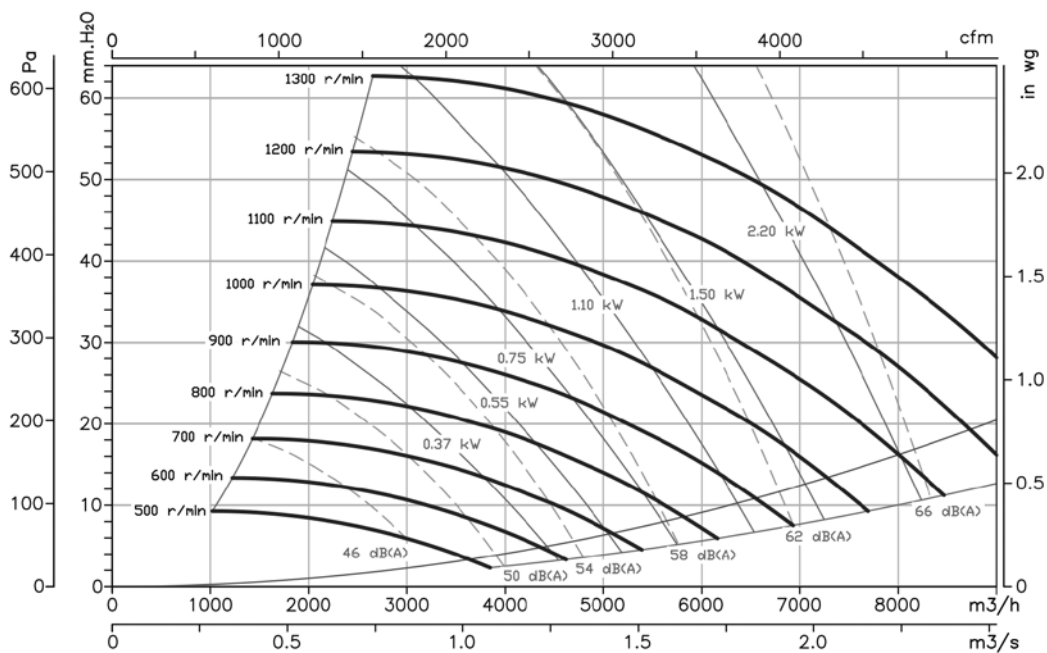

**Characteristic curves**

Q= Flow rate in m<sup>3</sup>/h, m<sup>3</sup>/s and cfm

Pe= Static pressure in mmH<sub>2</sub>O, Pa and inwg.

**15/15**

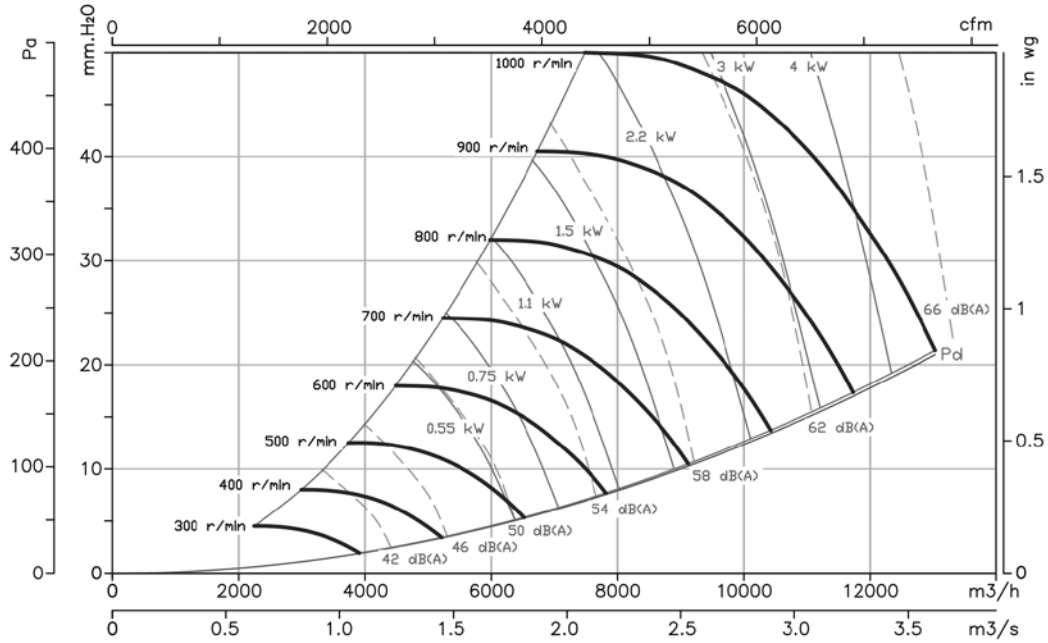

**18/18**

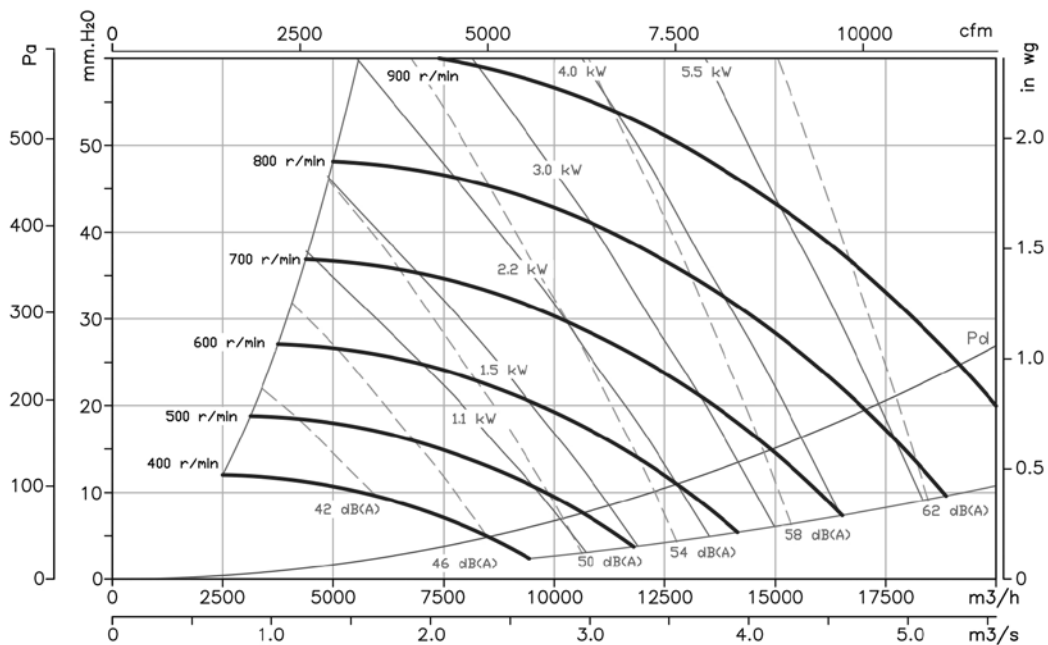

**Characteristic curves**

Q= Flow rate in m<sup>3</sup>/h, m<sup>3</sup>/s and cfm

Pe= Static pressure in mmH<sup>2</sup>O, Pa and inwg.

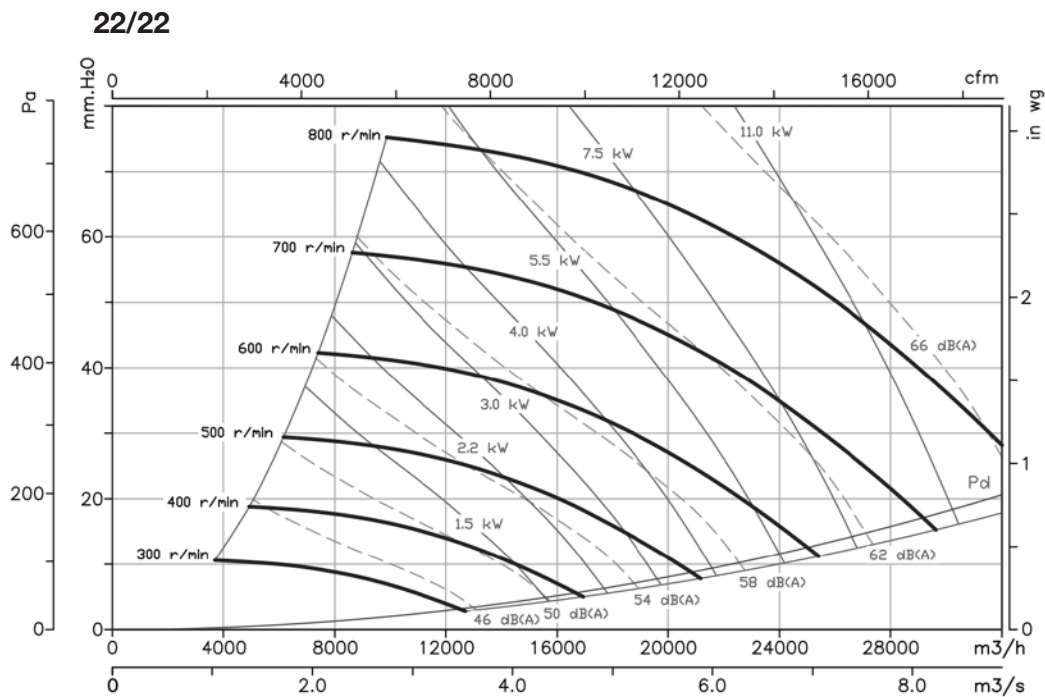
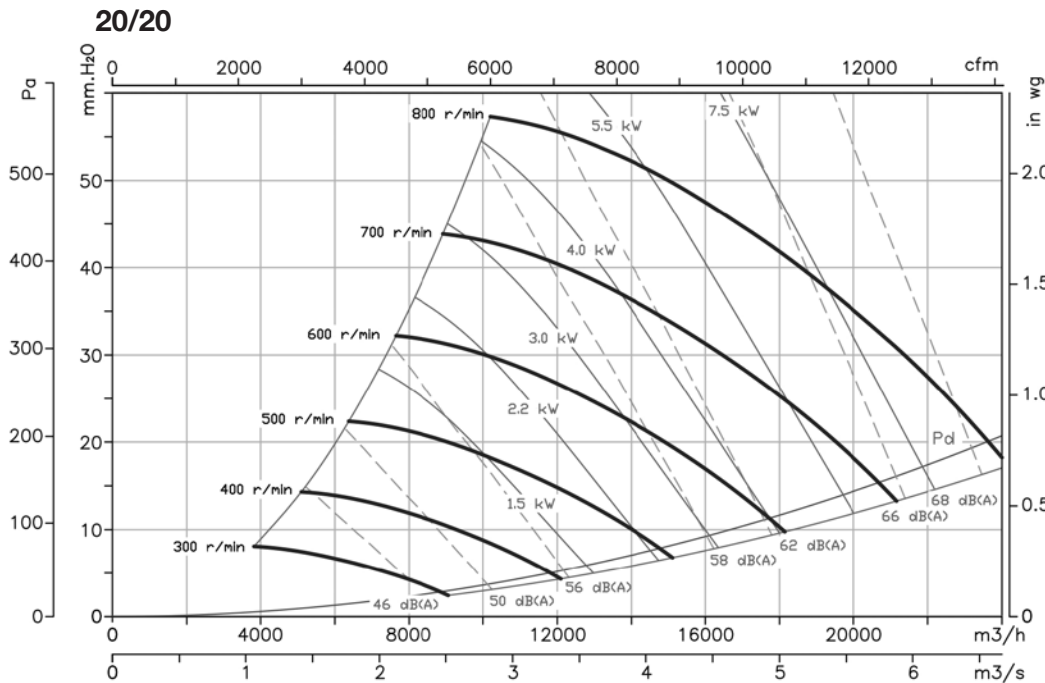

**Characteristic curves**

Q= Flow rate in m<sup>3</sup>/h, m<sup>3</sup>/s and cfm

Pe= Static pressure in mmH<sub>2</sub>O, Pa and inwg.

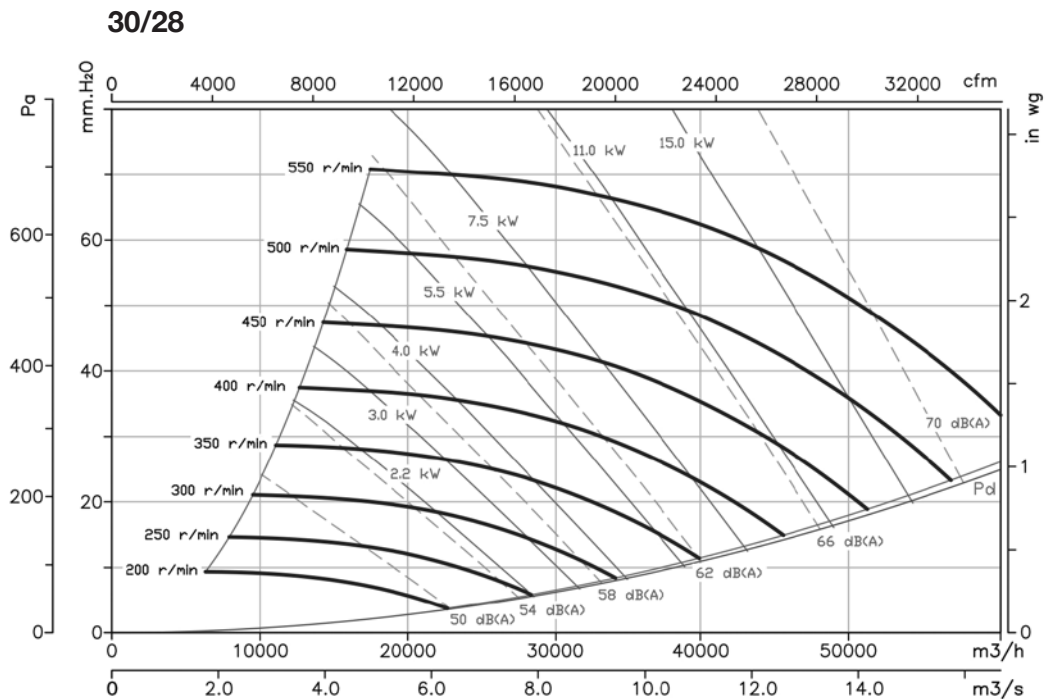
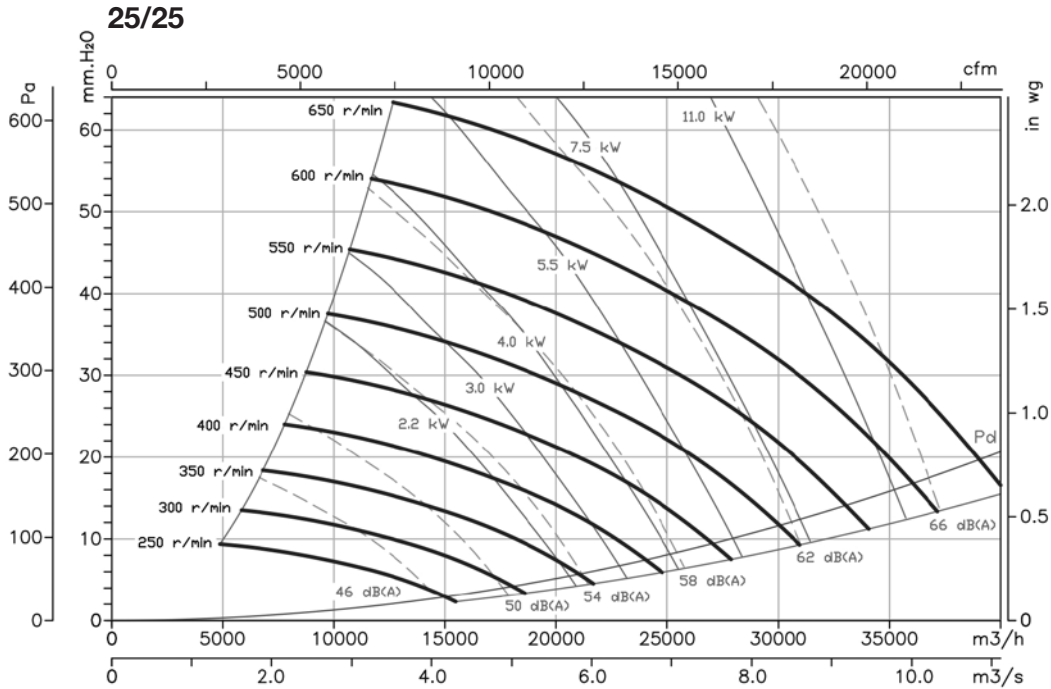

**Accessories**



INT

C2V

RM

VSD3/A-RFT

AET

VIS

TEJ

# CDXR CDXRT CJDXR

**CDXR:** Belt-driven double inlet centrifugal fans with shaft outlet on both sides and backward-curved impeller

**CDXRT:** Belt-driven double inlet centrifugal fans fitted with electric motors, a set of pulleys and belts, protectors and backward-curved impeller

**CJDXR:** Ventilation units with backward-curved impeller, acoustic insulation, fitted with fans from the CDXR series, resting on rubber shock-absorbers

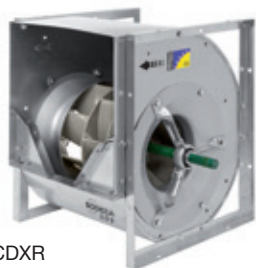

CDXR

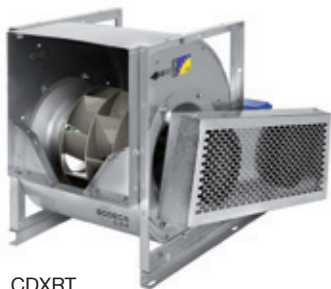

CDXRT



CJDXR

#### Fan:

- Galvanised sheet steel casing.
- Backward-curved impeller blades made of galvanised sheet steel.
- Galvanised sheet steel structure with thermal and acoustic insulation (CJDXR).
- Cable gland for cable entry (CJDXR).

#### Motor:

- IE3 efficiency motors for powers equal to or greater than 0.75kW except single-phase, 2-speed and 8-pole.
- Class F motors with ball bearings and IP55 protection.
- Multi voltage motor, special design valid for 220/380V 60Hz, 254/440V 60Hz, 265/460V 60Hz, 277/480V 60Hz.
- Maximum temperature of air to be carried: -20 °C. +60 °C.

#### Finish:

- Anti-corrosive finished galvanised sheet steel.

#### On request:

- Different impulsion nozzle positions.
- Special windings for different voltages.
- With 2-speed motors.

## Order code

CDXR

—

450

—

60Hz



CDXR: Belt-driven double inlet centrifugal fans with shaft outlet and backward-curved impeller



Impeller size mm

CDXRT

—

450

—

3

—

60Hz



CDXRT: Belt-driven double inlet centrifugal fans fitted with electric motors, impeller with backward-curved blades



Impeller size mm



Motor power (hp)

CJDXR: Ventilation units with a backward-curved impeller

## Technical characteristics

60Hz

Model	Max. speed (r/min)	Installed power (kW)	Maximum flow rate (m <sup>3</sup> /h)	Air temperature (°C)		Approx. weight (kg)
				min.	max.	
CDXR-200	4900	2.2	3950	-20	85	10.0
CDXR-250	4100	3.0	5500	-20	85	18.0
CDXR-315	3200	4.0	10550	-20	85	32.6
CDXR-355	2800	5.5	13950	-20	85	42.7
CDXR-400	2400	5.5	16000	-20	85	50.6
CDXR-450	2200	7.5	20700	-20	85	67.5
CDXR-500	2000	11.0	27200	-20	85	84.2
CDXR-560	1800	15.0	34710	-20	85	142.0
CDXR-630	1700	22.0	47000	-20	85	168.0
CDXR-710	1400	22	53750	-20	85	223



**Technical characteristics**

Model	Max. speed (r/min)	Max. admissible current (A)		Installed power (kW)	Maximum flow rate (m³/h)	Air temperature (°C)		Approx. weight (kg)	Type Assembly
		220-277V	380-480V			min.	max.		
CDXRT CJDXR 355-0.5	1085	1.84	1.06	0.37	5600	-20	+85	47.7	A
CDXRT CJDXR 355-0.75	1230	2.28	1.31	0.55	6400	-20	+85	49.3	A
CDXRT CJDXR 355-1	1360	3.10	1.79	0.75	7100	-20	+85	50.9	A
CDXRT CJDXR 355-1.5	1540	4.03	2.32	1.10	8060	-20	+85	52.6	A
CDXRT CJDXR 355-2	1700	5.96	3.44	1.50	8890	-20	+85	55.6	A
CDXRT CJDXR 355-3	1930	8.36	4.83	2.20	10100	-20	+85	58.4	A
CDXRT CJDXR 355-4	2180	10.96	6.33	3.00	11395	-20	+85	65.7	A
CDXRT CJDXR 355-5.5	2400	14.10	8.12	4.00	12545	-20	+85	72.7	B
CDXRT CJDXR 355-7.5	2670		11.60	5.50	13955	-20	+85	85.7	B
CDXRT CJDXR 400-0.75	1010	2.28	1.31	0.55	7340	-20	+85	57.2	A
CDXRT CJDXR 400-1	1130	3.10	1.79	0.75	8140	-20	+85	58.8	A
CDXRT CJDXR 400-1.5	1290	4.03	2.32	1.10	9350	-20	+85	60.5	A
CDXRT CJDXR 400-2	1420	5.96	3.44	1.50	10260	-20	+85	63.5	A
CDXRT CJDXR 400-3	1620	8.36	4.83	2.20	11650	-20	+85	66.3	A
CDXRT CJDXR 400-4	1820	10.96	6.33	3.00	13110	-20	+85	73.6	A
CDXRT CJDXR 400-5.5	2000	14.10	8.12	4.00	14430	-20	+85	80.6	B
CDXRT CJDXR 400-7.5	2230		11.60	5.50	16040	-20	+85	93.6	B
CDXRT CJDXR 450-1	940	3.10	1.79	0.75	9500	-20	+85	75.7	A
CDXRT CJDXR 450-1.5	1075	4.03	2.32	1.10	10750	-20	+85	77.4	A
CDXRT CJDXR 450-2	1190	5.96	3.44	1.50	11960	-20	+85	80.4	A
CDXRT CJDXR 450-3	1340	8.36	4.83	2.20	13600	-20	+85	83.2	A
CDXRT CJDXR 450-4	1510	10.96	6.33	3.00	15100	-20	+85	90.5	A
CDXRT CJDXR 450-5.5	1670	14.10	8.12	4.00	16835	-20	+85	97.5	B
CDXRT CJDXR 450-7.5	1850		11.60	5.50	18500	-20	+85	110.5	B
CDXRT CJDXR 450-10	2060		14.20	7.50	20760	-20	+85	120.5	B
CDXRT CJDXR 500-1.5	880	4.03	2.32	1.10	12460	-20	+85	94.1	A
CDXRT CJDXR 500-2	970	5.96	3.44	1.50	13815	-20	+85	97.1	A
CDXRT CJDXR 500-3	1100	8.36	4.83	2.20	15700	-20	+85	99.9	A
CDXRT CJDXR 500-4	1240	10.96	6.33	3.00	17650	-20	+85	107.2	A
CDXRT CJDXR 500-5.5	1370	14.10	8.12	4.00	19430	-20	+85	114.2	B
CDXRT CJDXR 500-7.5	1510		11.60	5.50	21600	-20	+85	127.2	B
CDXRT CJDXR 500-10	1675		14.20	7.50	23950	-20	+85	137.2	B
CDXRT CJDXR 500-15	1910		20.20	11.00	27220	-20	+85	156.2	B
CDXRT CJDXR 560-2	810	5.96	3.44	1.50	15620	-20	+85	154.9	A
CDXRT CJDXR 560-3	925	8.36	4.83	2.20	17830	-20	+85	157.7	A
CDXRT CJDXR 560-4	1050	10.96	6.33	3.00	20380	-20	+85	165.0	A
CDXRT CJDXR 560-5.5	1150	14.10	8.12	4.00	22170	-20	+85	172.0	B
CDXRT CJDXR 560-7.5	1290		11.60	5.50	24940	-20	+85	185.0	B
CDXRT CJDXR 560-10	1420		14.20	7.50	27658	-20	+85	195.0	B
CDXRT CJDXR 560-15	1610		20.20	11.00	31050	-20	+85	214.0	B
CDXRT CJDXR 560-20	1800		27.50	15.00	34710	-20	+85	227.0	B
CDXRT CJDXR 630-3	740	8.36	4.83	2.20	21210	-20	+85	183.7	A
CDXRT CJDXR 630-4	830	10.96	6.33	3.00	23860	-20	+85	191.0	A
CDXRT CJDXR 630-5.5	920	14.10	8.12	4.00	26260	-20	+85	198.0	B
CDXRT CJDXR 630-7.5	1020		11.60	5.50	29200	-20	+85	211.0	B
CDXRT CJDXR 630-10	1135		14.20	7.50	32385	-20	+85	221.0	B
CDXRT CJDXR 630-15	1285		20.20	11.00	36800	-20	+85	240.0	B
CDXRT CJDXR 630-20	1450		27.50	15.00	41415	-20	+85	253.0	B
CDXRT CJDXR 630-25	1550		35.00	18.50	44410	-20	+85	270.0	B
CDXRT CJDXR 630-30	1640		42.00	22.00	47050	-20	+85	313.0	B
CDXRT CJDXR 710-3	580	8.36	4.83	2.20	23200	-20	+85	238.7	A
CDXRT CJDXR 710-4	655	10.96	6.33	3.00	26200	-20	+85	246.0	A
CDXRT CJDXR 710-5.5	730	14.10	8.12	4.00	29200	-20	+85	253.0	B
CDXRT CJDXR 710-7.5	805		11.60	5.50	32200	-20	+85	266.0	B
CDXRT CJDXR 710-10	890		14.20	7.50	35600	-20	+85	276.0	B
CDXRT CJDXR 710-15	1015		20.20	11.00	40600	-20	+85	295.0	B
CDXRT CJDXR 710-20	1140		27.50	15.00	45600	-20	+85	308.0	B
CDXRT CJDXR 710-25	1225		35.00	18.50	49000	-20	+85	325.0	B
CDXRT CJDXR 710-30	1300		42.00	22.00	52000	-20	+85	368.0	B

Dimensions mm

CDXR 200 - 250

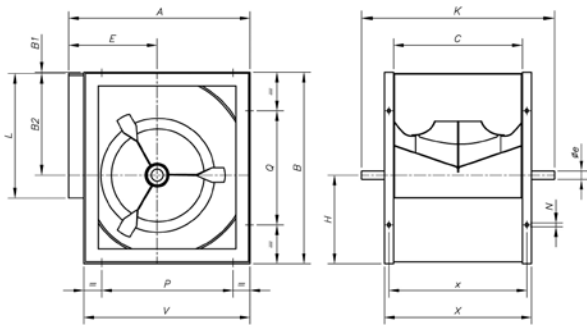

CDXR 315...710

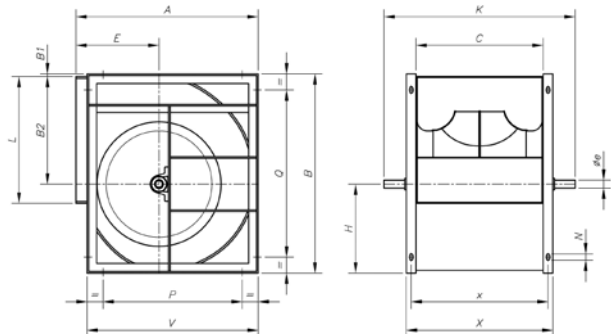

	A	B	B1	B2	C	E	øe	H	K	L	N	P	Q	V	X	x
CDXR-200	343	370	4	215	256	164	20	151	420	256	11x16	224	224	306	306	281
CDXR-250	419	461	4	270	322	195	20	187	490	322	11x16	224	224	384	372	347
CDXR-315	518	578	3	340	404	236	25	235	640	404	13x18	280	280	480	464	434
CDXR-355	578	655	6	383	453	261	30	266	700	453	13x18	355	355	548	533	493
CDXR-400	651	736	4.5	431.5	507	290	30	300	760	507	13x18	355	355	613	587	547
CDXR-450	728	827	5	486	569	322	35	336	845	569	13x18	530	530	681	649	609
CDXR-500	800	918	5	538	638	352	35	375	915	638	13x18	530	530	750	718	678
CDXR-560	893	1030	8	602	715	390	40	420	1000	715	13x18	530	530	845	815	765
CDXR-630	999	1157	7	678.5	801	434	45	471.5	1090	801	13x18	530	530	946	901	851
CDXR-710	1121	1303	7	765	898	485	50	531	1255	898	17x22	630	630	1058	998	948

CDXRT Assembly A

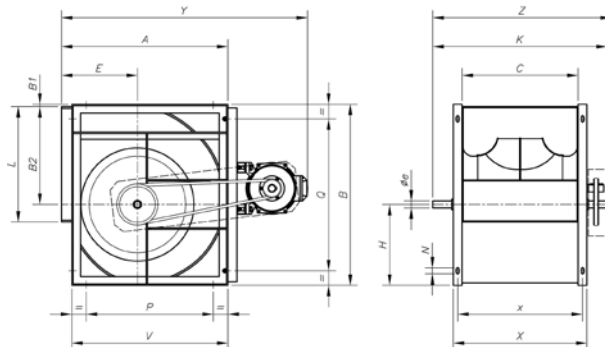

Model	A	B	B1	B2	C	E	øe	H	K	L	N	P	Q	V	X	x	Y	Z
CDXRT-355-0.5	578	655	6	383	453	261	30	266	700	453	13x18	355	355	548	533	493	830	780
CDXRT-355-0.75	578	655	6	383	453	261	30	266	700	453	13x18	355	355	548	533	493	850	780
CDXRT-355-1	578	655	6	383	453	261	30	266	700	453	13x18	355	355	548	533	493	850	780
CDXRT-355-1.5	578	655	6	383	453	261	30	266	700	453	13x18	355	355	548	533	493	870	780
CDXRT-355-2	578	655	6	383	453	261	30	266	700	453	13x18	355	355	548	533	493	870	780
CDXRT-355-3	578	655	6	383	453	261	30	266	700	453	13x18	355	355	548	533	493	885	780
CDXRT-355-4	578	655	6	383	453	261	30	266	700	453	13x18	355	355	548	533	493	885	780
CDXRT-400-0.75	651	736	4.5	431.5	507	290	30	300	760	507	13x18	355	355	613	587	547	925	840
CDXRT-400-1	651	736	4.5	431.5	507	290	30	300	760	507	13x18	355	355	613	587	547	925	840
CDXRT-400-1.5	651	736	4.5	431.5	507	290	30	300	760	507	13x18	355	355	613	587	547	940	840
CDXRT-400-2	651	736	4.5	431.5	507	290	30	300	760	507	13x18	355	355	613	587	547	940	840
CDXRT-400-3	651	736	4.5	431.5	507	290	30	300	760	507	13x18	355	355	613	587	547	956	840
CDXRT-400-4	651	736	4.5	431.5	507	290	30	300	760	507	13x18	355	355	613	587	547	956	840
CDXRT-450-1	728	827	5	486	569	322	35	336	845	569	13x18	530	530	681	649	609	1000	925
CDXRT-450-1.5	728	827	5	486	569	322	35	336	845	569	13x18	530	530	681	649	609	1020	925
CDXRT-450-2	728	827	5	486	569	322	35	336	845	569	13x18	530	530	681	649	609	1020	925
CDXRT-450-3	728	827	5	486	569	322	35	336	845	569	13x18	530	530	681	649	609	1035	925
CDXRT-450-4	728	827	5	486	569	322	35	336	845	569	13x18	530	530	681	649	609	1035	925
CDXRT-500-1.5	800	918	5	538	638	352	35	375	915	638	13x18	530	530	750	718	678	1090	995
CDXRT-500-2	800	918	5	538	638	352	35	375	915	638	13x18	530	530	750	718	678	1090	995
CDXRT-500-3	800	918	5	538	638	352	35	375	915	638	13x18	530	530	750	718	678	1105	995
CDXRT-500-4	800	918	5	538	638	352	35	375	915	638	13x18	530	530	750	718	678	1105	995
CDXRT-560-2	893	1030	8	602	715	390	40	420	1000	715	13x18	530	530	845	815	765	1185	1080
CDXRT-560-3	893	1030	8	602	715	390	40	420	1000	715	13x18	530	530	845	815	765	1205	1080
CDXRT-560-4	893	1030	8	602	715	390	40	420	1000	715	13x18	530	530	845	815	765	1205	1080
CDXRT-630-3	999	1157	7	678.5	801	434	45	471.5	1090	801	13x18	530	530	946	901	851	1310	1170
CDXRT-630-4	999	1157	7	678.5	801	434	45	471.5	1090	801	13x18	530	530	946	901	851	1310	1170
CDXRT-710-3	1121	1303	7	765	898	485	50	531	1255	898	17x22	630	630	1058	998	948	1435	1335
CDXRT-710-4	1121	1303	7	765	898	485	50	531	1255	898	17x22	630	630	1058	998	948	1435	1335

Dimensions mm

CDXRT  
Assembly B

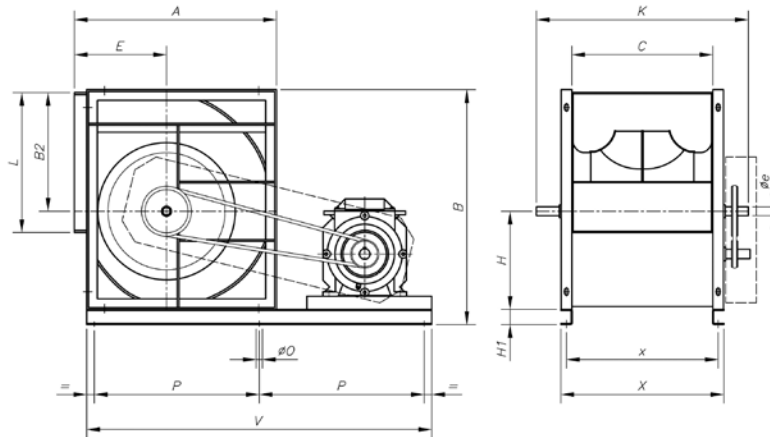

Model	A	B	B2	C	E	øe	H	H1	K	ø0	P	V	x	X
CDXRT-355-5.5	578	715	383	453	261	30	266	60	700	8	-	1110	493	533
CDXRT-355-7.5	578	715	383	453	261	30	266	60	700	8	-	1110	493	533
CDXRT-400-5.5	651	796	431.5	507	290	30	300	60	760	10	-	1210	547	587
CDXRT-400-7.5	651	796	431.5	507	290	30	300	60	760	10	-	1210	547	587
CDXRT-450-5.5	728	887	486	569	322	35	336	60	845	10	-	1330	609	649
CDXRT-450-7.5	728	887	486	569	322	35	336	60	845	10	-	1330	609	649
CDXRT-450-10	728	887	486	569	322	35	336	60	845	10	-	1330	609	649
CDXRT-500-5.5	800	978	538	638	352	35	375	60	915	10	670	1430	678	718
CDXRT-500-7.5	800	978	538	638	352	35	375	60	915	10	670	1430	678	718
CDXRT-500-10	800	978	538	638	352	35	375	60	915	10	670	1430	678	718
CDXRT-500-15	800	978	538	638	352	35	375	60	915	10	670	1430	678	718
CDXRT-560-5.5	893	1090	602	715	390	40	420	60	1000	10	745	1580	765	815
CDXRT-560-7.5	893	1090	602	715	390	40	420	60	1000	10	745	1580	765	815
CDXRT-560-10	893	1090	602	715	390	40	420	60	1000	10	745	1580	765	815
CDXRT-560-15	893	1090	602	715	390	40	420	60	1000	10	745	1580	765	815
CDXRT-560-20	893	1090	602	715	390	40	420	60	1000	10	745	1580	765	815
CDXRT-630-5.5	999	1217	678.5	801	434	45	471.5	60	1090	10	805	1700	851	901
CDXRT-630-7.5	999	1217	678.5	801	434	45	471.5	60	1090	10	805	1700	851	901
CDXRT-630-10	999	1217	678.5	801	434	45	471.5	60	1090	10	805	1700	851	901
CDXRT-630-15	999	1217	678.5	801	434	45	471.5	60	1090	10	805	1700	851	901
CDXRT-630-20	999	1217	678.5	801	434	45	471.5	60	1090	10	805	1700	851	901
CDXRT-630-25	999	1217	678.5	801	434	45	471.5	60	1090	10	805	1700	851	901
CDXRT-630-30	999	1217	678.5	801	434	45	471.5	60	1090	10	805	1700	851	901
CDXRT-710-5.5	1121	1383	765	898	485	50	531	80	1255	10	955	2000	948	998
CDXRT-710-7.5	1121	1383	765	898	485	50	531	80	1255	10	955	2000	948	998
CDXRT-710-10	1121	1383	765	898	485	50	531	80	1255	10	955	2000	948	998
CDXRT-710-15	1121	1383	765	898	485	50	531	80	1255	10	955	2000	948	998
CDXRT-710-20	1121	1383	765	898	485	50	531	80	1255	10	955	2000	948	998
CDXRT-710-25	1121	1383	765	898	485	50	531	80	1255	10	955	2000	948	998
CDXRT-710-30	1121	1383	765	898	485	50	531	80	1255	10	955	2000	948	998

CJDXR

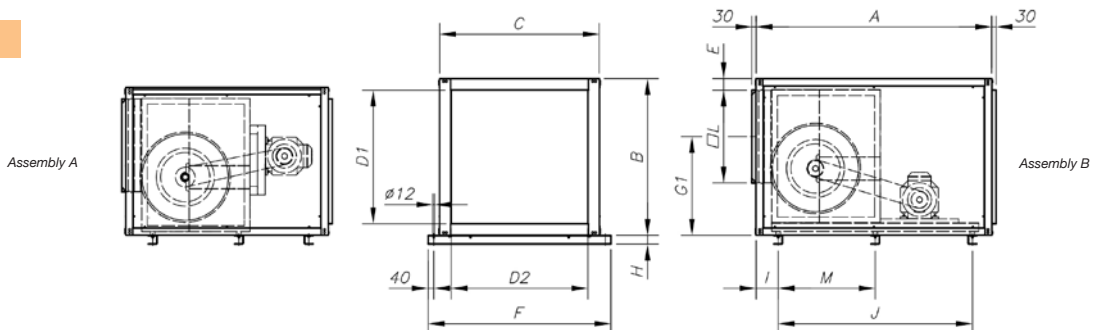

Model	A	B	C	D1	D2	E	F	G1	H	I	J	L	M
CJDXR-355	1265	815	800	655	640	84.5	960	503.5	60	165	1020	454	-
CJDXR-400	1370	900	900	740	743	82	1060	564	60	152	1120	508	-
CJDXR-450	1480	990	1000	830	843	80.5	1160	623.5	60	152	1240	570	-
CJDXR-500	1625	1080	1100	920	942	80	1260	680.5	60	152	1340	639	670
CJDXR-560	1760	1195	1200	1035	1040	82.5	1360	851.5	60	165	1490	716	745
CJDXR-630	1880	1322	1300	1162	1142	80	1460	841	60	152	1610	802	820
CJDXR-710	2180	1500	1500	1340	1342	82	1660	968.5	80	168	1910	899	955

**Characteristic curves**

Q= Flow rate in m<sup>3</sup>/h, m<sup>3</sup>/s and cfm

Pe= Static pressure in mmH<sub>2</sub>O, Pa and inwg.

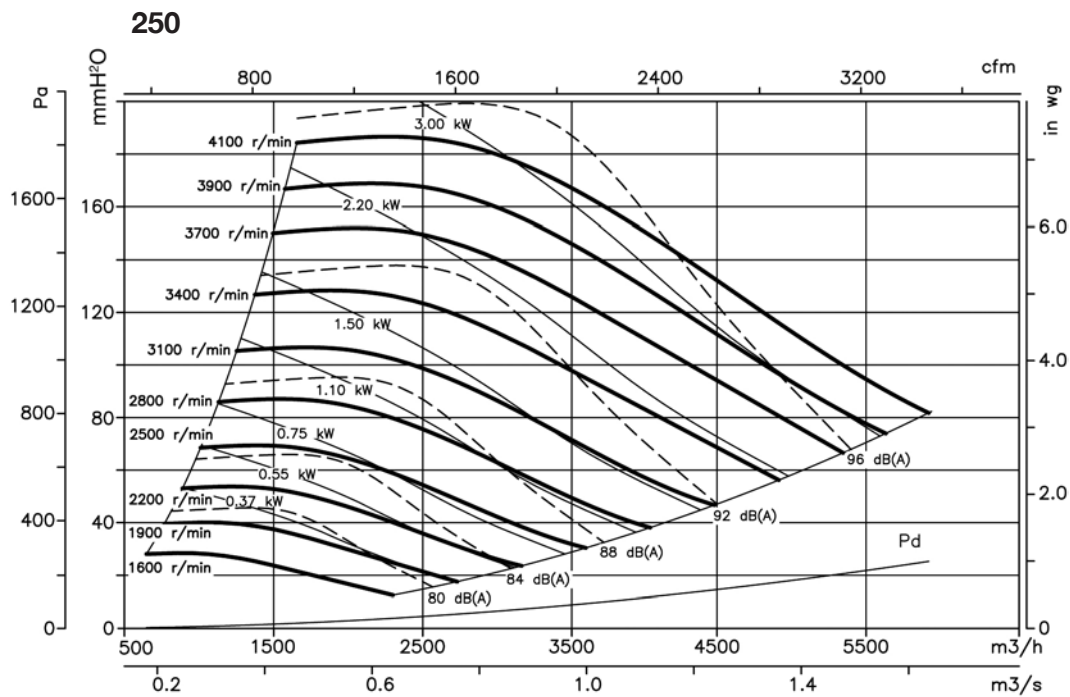
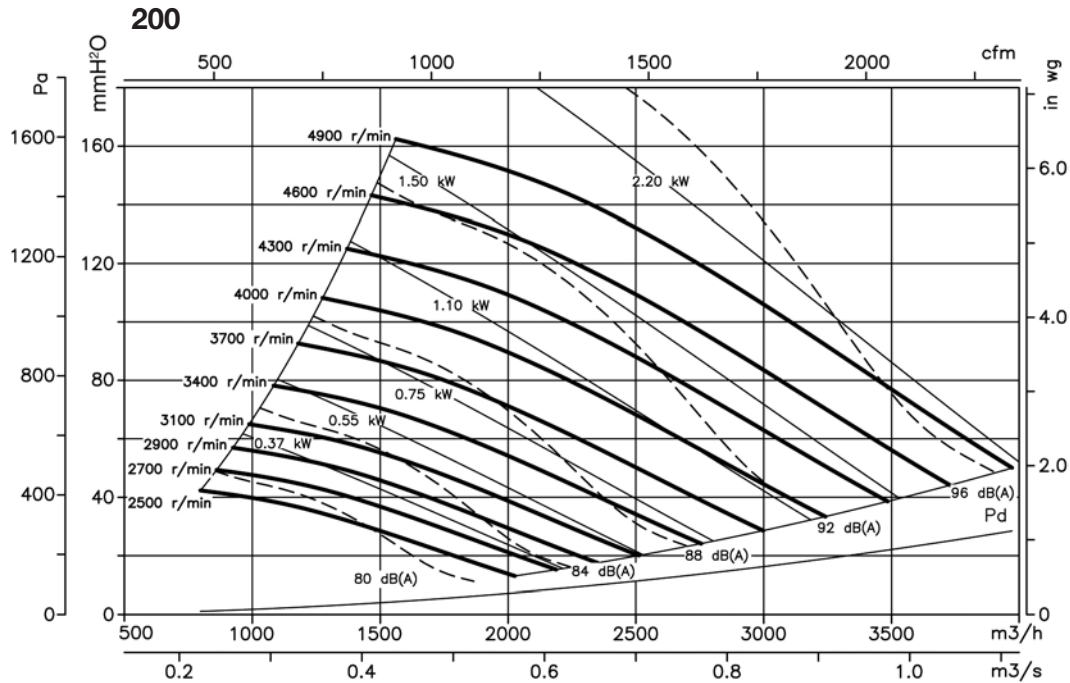

**Characteristic curves**

Q= Flow rate in m<sup>3</sup>/h, m<sup>3</sup>/s and cfm

Pe= Static pressure in mmH<sup>2</sup>O, Pa and inwg.

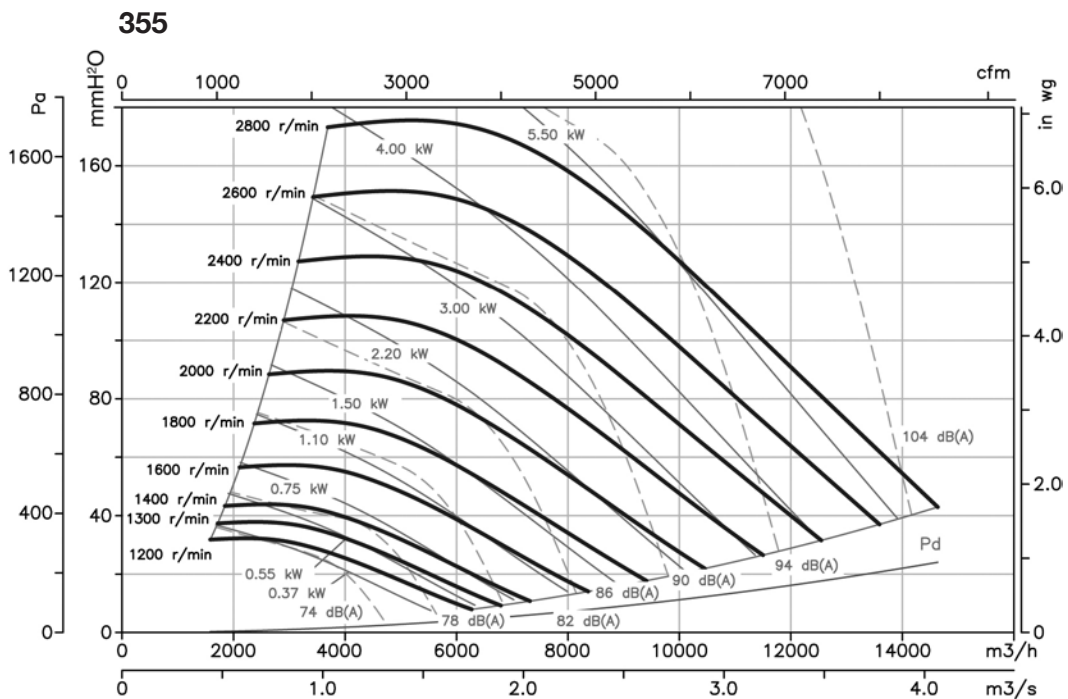
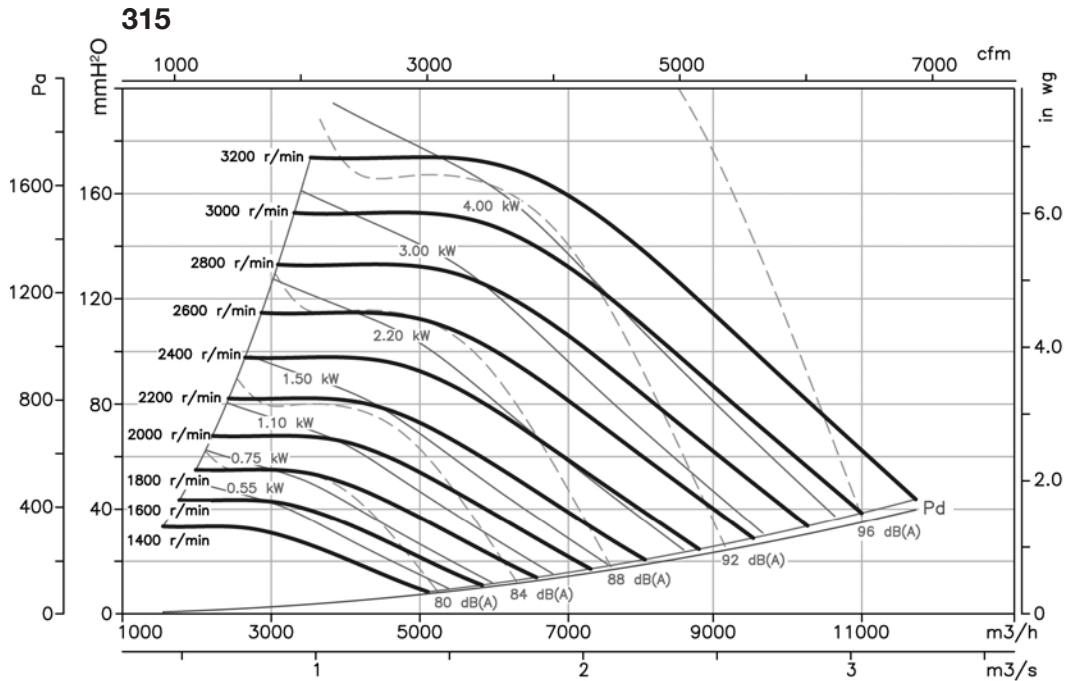

**Characteristic curves**

Q= Flow rate in m<sup>3</sup>/h, m<sup>3</sup>/s and cfm.

Pe= Static pressure in mm H<sub>2</sub>O, Pa and inwg.

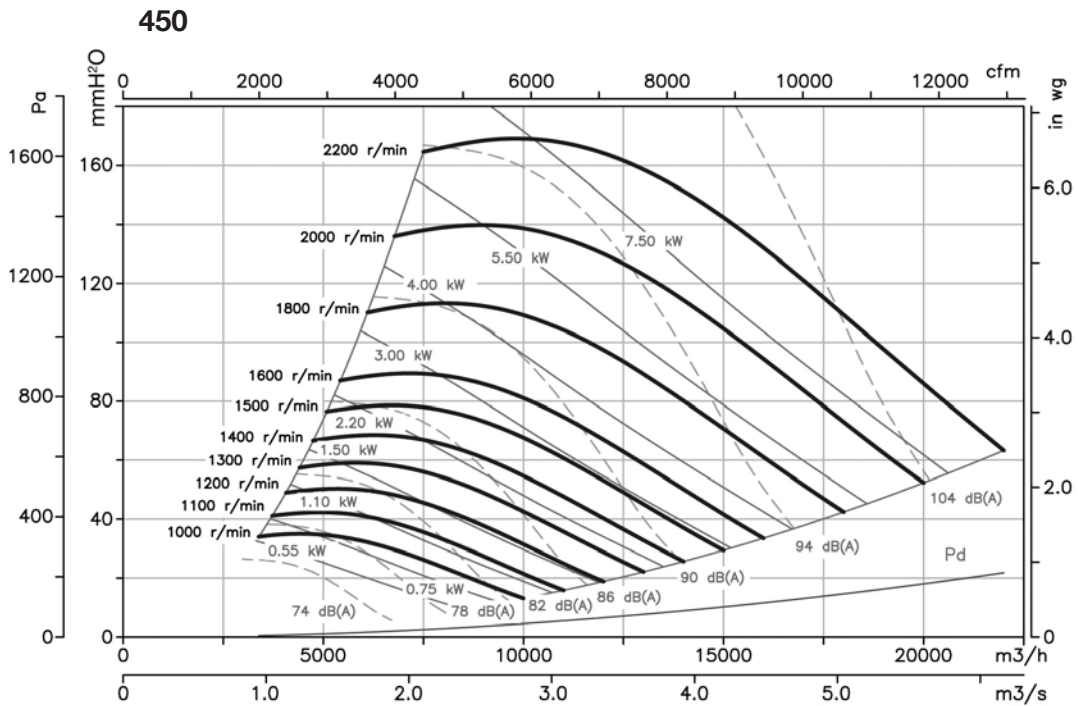
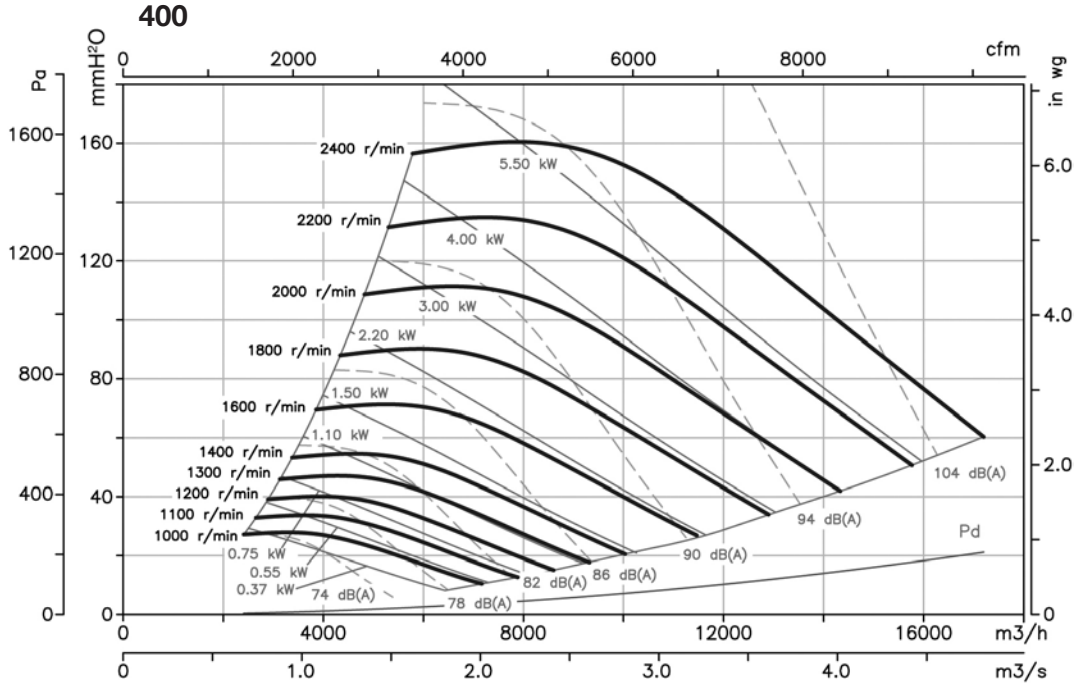

**Characteristic curves**

Q= Flow rate in m<sup>3</sup>/h, m<sup>3</sup>/s and cfm.

Pe= Static pressure in mm H<sub>2</sub>O, Pa and inwg.

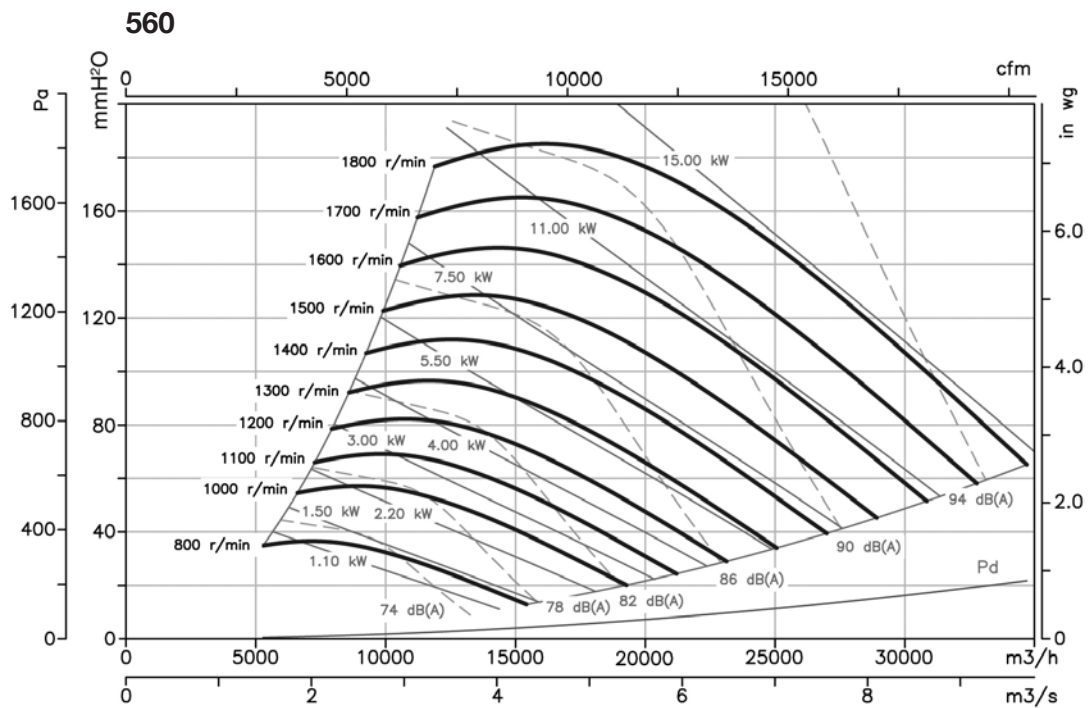
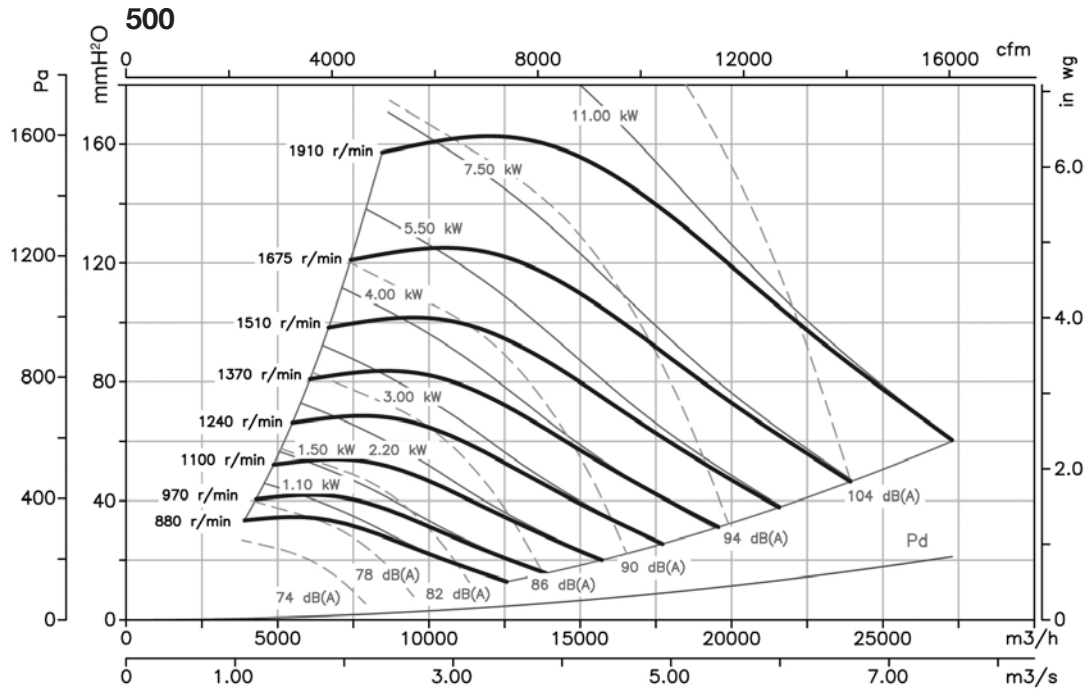

**Characteristic curves**

Q= Flow rate in m<sup>3</sup>/h, m<sup>3</sup>/s and cfm.

Pe= Static pressure in mm H<sup>2</sup>O, Pa and inwg.

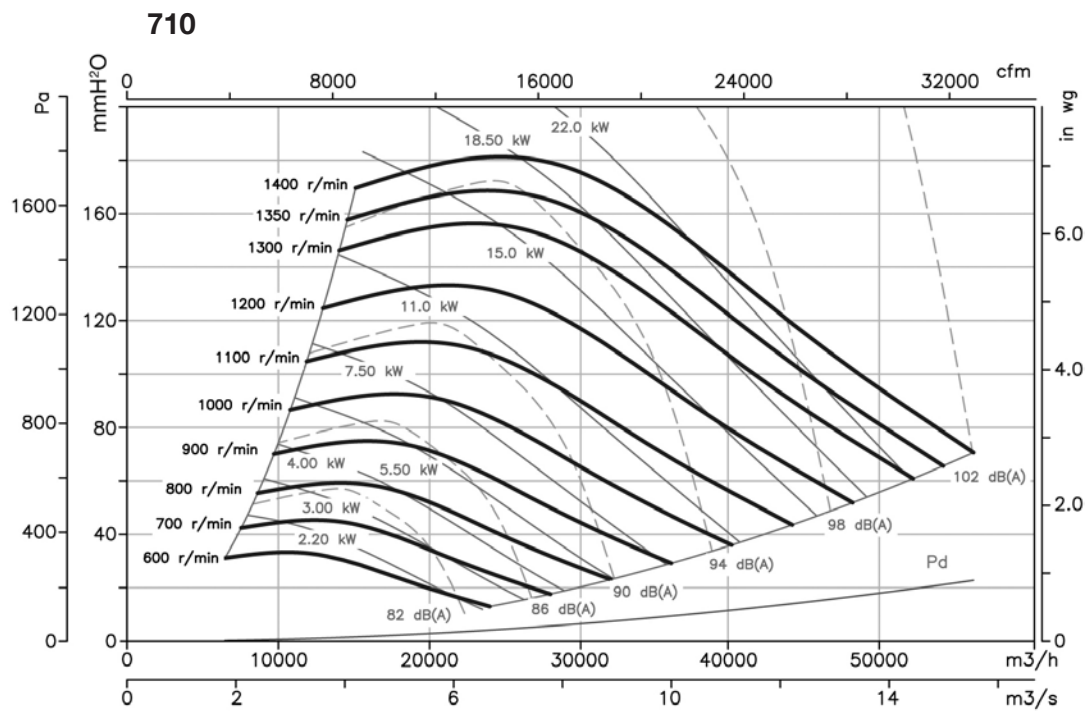
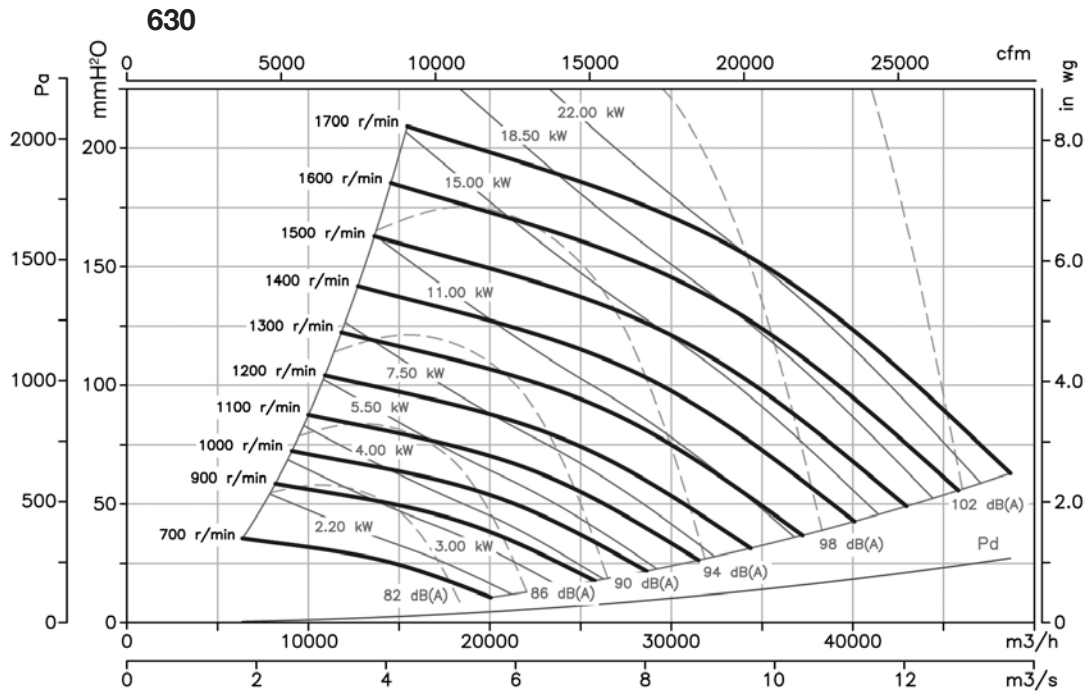

**Accessories**



INT C2V RM VSD3/A-RFT AET VIS TEJ



# CSXR CSXRT CJSXR

**CSXR:** Belt-driven single inlet centrifugal fans with shaft outlet and backward-curved impeller

**CSXRT:** Belt-driven single inlet centrifugal fans fitted with electric motors, a set of pulleys and belts, protectors and backward-curved impeller

**CJSXR:** Ventilation units with backward-curved impeller, acoustic insulation, fitted with fans from the CSXR series, resting on rubber shock-absorbers



CSXR



CSXRT



CJSXR

**Fan:**

- Galvanised sheet steel casing.
- Backward-curved impeller blades made of galvanised sheet steel.
- Galvanised sheet steel structure with thermal and acoustic insulation (CJSXR).
- Cable gland for cable entry (CJSXR).

**Motor:**

- IE3 efficiency motors for powers equal to or greater than 0.75kW except single-phase, 2-speed and 8-pole.
- Class F motors with ball bearings and IP55 protection.
- Multi voltage motor, special design valid for 220/380V 60Hz, 254/440V 60Hz, 265/460V 60Hz, 277/480V 60Hz.
- Maximum temperature of air to be carried: -20 °C. +60 °C.

**Finish:**

- Anti-corrosive finished galvanised sheet steel.

**On request:**

- Different impulsion nozzle positions.
- Special windings for different voltages.
- With 2-speed motors.

**Order code**



CSXR: Single inlet centrifugal fans with free shaft outlet

Impeller size



CSXRT: Single inlet, belt-driven centrifugal fans fitted with electric motors

Impeller size

Motor power (hp)

CJSXR: Ventilation units with a backward-curved impeller

**Technical characteristics**

60Hz

Model	Max. speed (r/min)	Max. installed power (kW)	Maximum flow rate (m³/h)	Minimum Air temperature (°C)		Approx. weight (kg)
				min.	max.	
CSXR-315	3200	1.50	4345	-20	+85	27
CSXR-355	2800	2.20	5905	-20	+85	39
CSXR-400	2400	3.00	7850	-20	+85	44
CSXR-450	2200	4,00	10045	-20	+85	55
CSXR-500	2200	5.50	12855	-20	+85	70
CSXR-560	2000	7.50	17555	-20	+85	110
CSXR-630	1600	7.50	18600	-20	+85	125
CSXR-710	1400	7.50	23200	-20	+85	175
CSXR-800	1600	22,00	39430	-20	+85	252
CSXR-900	1400	30,00	46375	-20	+85	360
CSXR-1000	1400	45,00	58225	-20	+85	445

### Technical characteristics

Model	Max. speed (r/min)	Max. admissible current (A)		Installed power (kW)	Maximum flow rate (m <sup>3</sup> /h)	Approx. weight (kg)	Type Assembly	
		220-277V	380-480V				CSXRT	CJSXR
CSXRT CJSXR 315-0.75	2520	2.4	1.4	0.55	4000	32	A	B
CSXRT CJSXR 315-1	2800	3.1	1.8	0.75	4500	34	A	B
CSXRT CJSXR 315-1.5	3250	4.4	2.5	1.1	5050	36	A	B
CSXRT CJSXR 355-0.75	2100	2.4	1.4	0.55	4750	41	A	B
CSXRT CJSXR 355-1	2300	3.1	1.8	0.75	5200	44	A	B
CSXRT CJSXR 355-1.5	2600	4.4	2.5	1.1	6000	46	A	B
CSXRT CJSXR 355-2	2875	5.8	3.4	1.5	6650	48	A	B
CSXRT CJSXR 400-0.75	1730	2.4	1.4	0.55	5600	49	A	B
CSXRT CJSXR 400-1	1900	3.3	1.9	0.75	6100	52	A	B
CSXRT CJSXR 400-1.5	2180	4.5	2.6	1.1	7000	54	A	B
CSXRT CJSXR 400-2	2400	5.8	3.4	1.5	7700	56	A	B
CSXRT CJSXR 450-0.75	1230	2.4	1.4	0.55	5800	61	A	B
CSXRT CJSXR 450-1	1380	3.3	1.9	0.75	6500	64	A	B
CSXRT CJSXR 450-1.5	1550	4.5	2.6	1.1	7500	66	A	B
CSXRT CJSXR 450-2	1700	6.0	3.5	1.5	8050	68	A	B
CSXRT CJSXR 450-3	1950	8.4	4.8	2.2	9050	72	A	B
CSXRT CJSXR 450-4	2200	10.4	6.0	3	10100	76	A	B
CSXRT CJSXR 500-1.5	1250	4.5	2.6	1.1	8200	88	A	B
CSXRT CJSXR 500-2	1380	6.0	3.5	1.5	9000	90	A	B
CSXRT CJSXR 500-3	1560	8.4	4.8	2.2	10200	93	A	B
CSXRT CJSXR 500-4	1730	11.3	6.5	3	11500	98	A	B
CSXRT CJSXR 500-5.5	1900	13.9	8.0	4	12500	107	A	B
CSXRT CJSXR 500-7.5	2130	-	11.1	5.5	14000	116	A	B
CSXRT CJSXR 560-2	1200	6.0	3.5	1.5	11000	100	A	B
CSXRT CJSXR 560-3	1380	8.4	4.8	2.2	12200	103	A	B
CSXRT CJSXR 560-4	1500	11.3	6.5	3	14000	108	A	B
CSXRT CJSXR 560-5.5	1670	13.9	8.0	4	15500	117	A	B
CSXRT CJSXR 560-7.5	1850	-	11.1	5.5	16200	122	A	B
CSXRT CJSXR 560-10	2050	-	14.8	7.5	18300	132	A	B
CSXRT CJSXR 630-3	1060	8.4	4.8	2.2	13200	119	A	B
CSXRT CJSXR 630-4	1150	11.3	6.5	3	14400	123	A	B
CSXRT CJSXR 630-5.5	1300	13.9	8.0	4	16000	132	A	B
CSXRT CJSXR 630-7.5	1450	-	11.1	5.5	18000	138	A	B
CSXRT CJSXR 630-10	1600	-	14.8	7.5	19800	147	A	B
CSXRT CJSXR 710-4	1000	11.3	6.5	3	17280	186	A	B
CSXRT CJSXR 710-5.5	1100	13.9	8.0	4	19080	195	A	B
CSXRT CJSXR 710-7.5	1200	-	11.1	5.5	20880	200	A	B
CSXRT CJSXR 710-10	1350	-	14.8	7.5	23760	210	A	B
CSXRT CJSXR 710-12.5	1480	-	17.5	9.2	25920	219	A	B
CSXRT 800-4	800	11.3	6.5	3	20800	226	B	
CSXRT 800-5.5	880	13.9	8.0	4	22680	234	B	
CSXRT 800-7.5	970	-	11.1	5.5	25100	240	B	
CSXRT 800-10	1070	-	14.8	7.5	27720	250	B	
CSXRT 800-12.5	1150	-	17.5	9.2	30000	259	B	
CSXRT 800-15	1230	-	22.0	11	32040	284	B	
CSXRT 800-20	1350	-	29.0	15	34000	305	B	
CSXRT 800-25	1450	-	36.5	18.5	37800	325	B	
CSXRT 800-30	1540	-	42.0	22	40000	344	B	
CSXRT 900-4	650	11.3	6.5	3	23760	281	B	
CSXRT 900-5.5	720	13.9	8.0	4	26000	289	B	
CSXRT 900-7.5	790	-	11.1	5.5	29500	295	B	
CSXRT 900-10	860	-	14.8	7.5	32100	305	B	
CSXRT 900-12.5	940	-	17.5	9.2	34200	314	B	
CSXRT 900-15	1020	-	22.0	11	37900	339	B	
CSXRT 900-20	1120	-	29.0	15	42000	360	B	
CSXRT 900-25	1190	-	36.5	18.5	43500	380	B	
CSXRT 900-30	1250	-	42.0	22	45500	399	B	
CSXRT 900-40	1400	-	59.0	30	51000	453	B	
CSXRT 1000-5.5	600	13.9	8.0	4	30500	342	B	
CSXRT 1000-7.5	660	-	11.1	5.5	33000	348	B	
CSXRT 1000-10	730	-	14.8	7.5	37000	358	B	
CSXRT 1000-12.5	790	-	17.5	9.2	40000	366	B	
CSXRT 1000-15	840	-	22.0	11	42500	392	B	
CSXRT 1000-20	940	-	29.0	15	46000	413	B	
CSXRT 1000-25	1000	-	36.5	18.5	50000	432	B	
CSXRT 1000-30	1060	-	42.0	22	52500	452	B	
CSXRT 1000-40	1160	-	59.0	30	59000	506	B	
CSXRT 1000-50	1260	-	68.0	37	64000	549	B	

Dimensions mm

CSXR

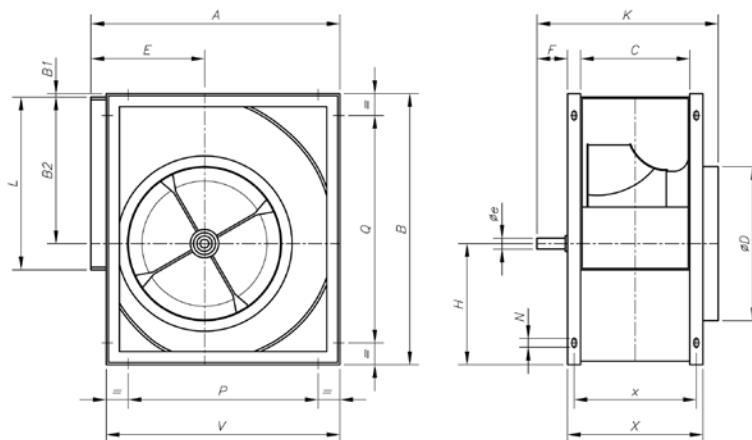

Model	A	B	B1	B2	C	øD	øe	E	F	H	K	L	N	P	Q	V	X	x
CSXR-315	518	578	3	340	223	322	25	236	83	235	395	404	13x18	280	280	480	283	253
CSXR-355	578	655	6	383	247	362	30	261	78	266	425	453	13x18	355	355	548	327	287
CSXR-400	651	736	4.5	431.5	274	404	30	290	78	300	452	507	13x18	355	355	613	354	314
CSXR-450	726	827	5	486	308	448	35	322	92	336	500	569	13x18	530	530	681	388	348
CSXR-500	800	918	5	538	344	510	35	352	92	375	535	638	13x18	530	530	750	424	394
CSXR-560	893	1030	8	602	383	570	40	390	87	420	600	715	13x18	530	530	845	483	433
CSXR-630	999	1157	7	678.5	432	635	45	434	87	471.5	650	801	13x18	530	530	946	532	482
CSXR-710	1121	1303	7	765	478	722	50	485	115	531	725	898	17x22	630	630	1058	578	528

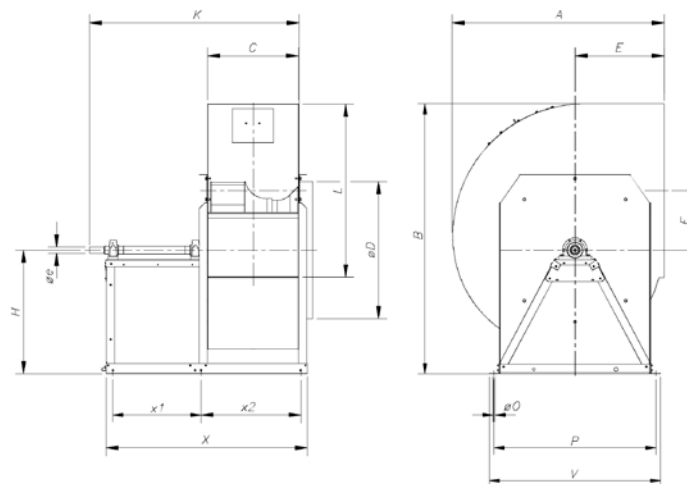

Model	A	B	C	L	øD	H	øe	E	F	K	X	ø0	P	V	x1	x2
CSXR-800	1250	1615.5	533	1010	798	762	42	535	358.5	1291.5	1231.5	14	980	1050	515	614
CSXR-900	1408	1475	595	1130	898	850	48	604	407	1353.5	1293.5	14	1080	1150	515	676
CSXR-1000	1541	1966	663	1260	998	900	48	651	433	1529.5	1468.5	14	1180	1250	642	729.5

### Dimensions mm

#### CSXRT

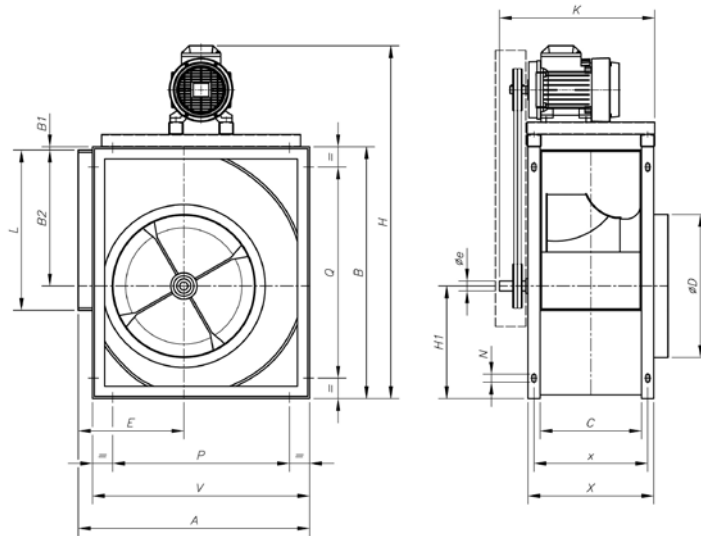

Model	A	B	B1	B2	C	øD	øe	E	H	H1	K	L	N	P	Q	V	X	x
CSXRT-315-0.75	518	578	3	340	223	322	25	236	835	235	395	404	13x18	280	280	480	283	253
CSXRT-315-1	518	578	3	340	223	322	25	236	855	235	395	404	13x19	280	280	480	283	253
CSXRT-315-1.5	518	578	3	340	223	322	25	236	855	235	395	404	13x20	280	280	480	283	253
CSXRT-315-2	518	578	3	340	223	322	25	236	875	235	395	404	13x21	280	280	480	283	253
CSXRT-315-3	518	578	3	340	223	322	25	236	875	235	395	404	13x22	280	280	480	283	253
CSXRT-355-0.75	578	655	6	383	247	362	30	261	910	266	425	453	13x18	355	355	548	327	287
CSXRT-355-1	578	655	6	383	247	362	30	261	930	266	425	453	13x19	355	355	548	327	287
CSXRT-355-1.5	578	655	6	383	247	362	30	261	930	266	425	453	13x20	355	355	548	327	287
CSXRT-355-2	578	655	6	383	247	362	30	261	945	266	425	453	13x21	355	355	548	327	287
CSXRT-355-3	578	655	6	383	247	362	30	261	945	266	425	453	13x22	355	355	548	327	287
CSXRT-355-4	578	655	6	383	247	362	30	261	963	266	425	453	13x23	355	355	548	327	287
CSXRT-400-0.75	651	736	4.5	431.5	274	404	30	290	1012	300	452	507	13x18	355	355	613	354	314
CSXRT-400-1	651	736	4.5	431.5	274	404	30	290	1012	300	452	507	13x19	355	355	613	354	314
CSXRT-400-1.5	651	736	4.5	431.5	274	404	30	290	1012	300	452	507	13x20	355	355	613	354	314
CSXRT-400-2	651	736	4.5	431.5	274	404	30	290	1033	300	452	507	13x21	355	355	613	354	314
CSXRT-400-3	651	736	4.5	431.5	274	404	30	290	1033	300	452	507	13x22	355	355	613	354	314
CSXRT-400-4	651	736	4.5	431.5	274	404	30	290	1045	300	452	507	13x23	355	355	613	354	314
CSXRT-400-5.5	651	736	4.5	431.5	274	404	30	290	1072	300	452	507	13x24	355	355	613	354	314
CSXRT-450-0.75	726	827	5	486	308	448	35	322	1100	336	500	569	13x18	530	530	681	388	348
CSXRT-450-1	726	827	5	486	308	448	35	322	1100	336	500	569	13x19	530	530	681	388	348
CSXRT-450-1.5	726	827	5	486	308	448	35	322	1120	336	500	569	13x20	530	530	681	388	348
CSXRT-450-2	726	827	5	486	308	448	35	322	1120	336	500	569	13x21	530	530	681	388	348
CSXRT-450-3	726	827	5	486	308	448	35	322	1138	336	500	569	13x22	530	530	681	388	348
CSXRT-450-4	726	827	5	486	308	448	35	322	1138	336	500	569	13x23	530	530	681	388	348
CSXRT-450-5.5	726	827	5	486	308	448	35	322	1162	336	500	569	13x24	530	530	681	388	348
CSXRT-450-7.5	726	827	5	486	308	448	35	322	1205	336	500	569	13x25	530	530	681	388	348
CSXRT-450-10	726	827	5	486	308	448	35	322	1205	336	500	569	13x26	530	530	681	388	348
CSXRT-450-12.5	726	827	5	486	308	448	35	322	1205	336	500	569	13x27	530	530	681	388	348
CSXRT-500-1.5	800	918	5	538	344	510	35	352	1214	375	535	638	13x18	530	530	750	424	394
CSXRT-500-2	800	918	5	538	344	510	35	352	1214	375	535	638	13x19	530	530	750	424	394
CSXRT-500-3	800	918	5	538	344	510	35	352	1228	375	535	638	13x20	530	530	750	424	394
CSXRT-500-4	800	918	5	538	344	510	35	352	1228	375	535	638	13x21	530	530	750	424	394
CSXRT-500-5.5	800	918	5	538	344	510	35	352	1255	375	535	638	13x22	530	530	750	424	394
CSXRT-500-7.5	800	918	5	538	344	510	35	352	1292	375	535	638	13x23	530	530	750	424	394
CSXRT-500-10	800	918	5	538	344	510	35	352	1292	375	535	638	13x24	530	530	750	424	394
CSXRT-500-12.5	800	918	5	538	344	510	35	352	1292	375	535	638	13x25	530	530	750	424	394
CSXRT-500-15	800	918	5	538	344	510	35	352	1350	375	535	638	13x26	530	530	750	424	394
CSXRT-560-2	893	1030	8	602	383	570	40	390	1325	420	600	715	13x18	530	530	845	483	433

Dimensions mm

Model	A	B	B1	B2	C	øD	øe	E	H	H1	K	L	N	P	Q	V	X	x
CSXRT-560-3	893	1030	8	602	383	570	40	390	1340	420	600	715	13x19	530	530	845	483	433
CSXRT-560-4	893	1030	8	602	383	570	40	390	1340	420	600	715	13x20	530	530	845	483	433
CSXRT-560-5.5	893	1030	8	602	383	570	40	390	1365	420	600	715	13x21	530	530	845	483	433
CSXRT-560-7.5	893	1030	8	602	383	570	40	390	1410	420	600	715	13x22	530	530	845	483	433
CSXRT-560-10	893	1030	8	602	383	570	40	390	1410	420	600	715	13x23	530	530	845	483	433
CSXRT-560-12.5	893	1030	8	602	383	570	40	390	1410	420	600	715	13x24	530	530	845	483	433
CSXRT-560-15	893	1030	8	602	383	570	40	390	1464	420	600	715	13x25	530	530	845	483	433
CSXRT-630-3	999	1157	7	678.5	432	635	45	434	1470	471.5	650	801	13x18	530	530	946	532	482
CSXRT-630-4	999	1157	7	678.5	432	635	45	434	1470	471.5	650	801	13x19	530	530	946	532	482
CSXRT-630-5.5	999	1157	7	678.5	432	635	45	434	1492	471.5	650	801	13x20	530	530	946	532	482
CSXRT-630-7.5	999	1157	7	678.5	432	635	45	434	1531	471.5	650	801	13x21	530	530	946	532	482
CSXRT-630-10	999	1157	7	678.5	432	635	45	434	1531	471.5	650	801	13x22	530	530	946	532	482
CSXRT-630-12.5	999	1157	5	678.5	432	635	45	434	1531	471.5	650	801	13x23	530	530	946	532	482
CSXRT-630-15	999	1157	7	678.5	432	635	45	434	1590	471.5	650	801	13x24	530	530	946	532	482
CSXRT-630-20	999	1157	7	678.5	432	635	45	434	1590	471.5	650	801	13x25	530	530	946	532	482
CSXRT-710-4	1121	1303	7	765	478	722	50	485	1612	531	725	898	17x22	630	630	1058	578	528
CSXRT-710-5.5	1121	1303	7	765	478	722	50	485	1638	531	725	898	17x23	630	630	1058	578	528
CSXRT-710-7.5	1121	1303	7	765	478	722	50	485	1675	531	725	898	17x24	630	630	1058	578	528
CSXRT-710-10	1121	1303	7	765	478	722	50	485	1675	531	725	898	17x25	630	630	1058	578	528
CSXRT-710-12.5	1121	1303	7	765	478	722	50	485	1675	531	725	898	17x26	630	630	1058	578	528
CSXRT-710-15	1121	1303	7	765	478	722	50	485	1735	531	725	898	17x27	630	630	1058	578	528
CSXRT-710-20	1121	1303	7	765	478	722	50	485	1735	531	725	898	17x28	630	630	1058	578	528
CSXRT-710-25	1121	1303	7	765	478	722	50	485	1820	531	725	898	17x29	630	630	1058	578	528

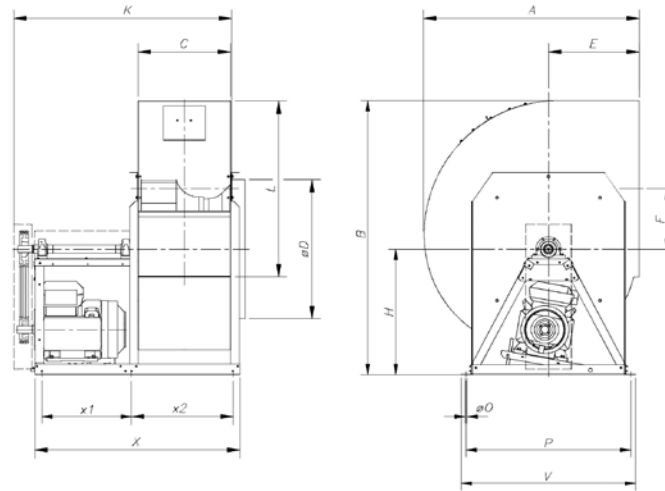

Model	A	B	C	L	øD	H	E	F	K	X	øO	P	V	x1	x2
CSXRT-800	1250	1615.5	533	1010	798	762	535	358.5	1321.5	1231.5	14	980	1050	515	614
CSXRT-900	1408	1475	595	1130	898	850	604	407	1383.5	1293.5	14	1080	1150	515	676
CSXRT-1000	1541	1966	663	1260	998	900	651	433	1559.5	1468.5	14	1180	1250	642	729.5

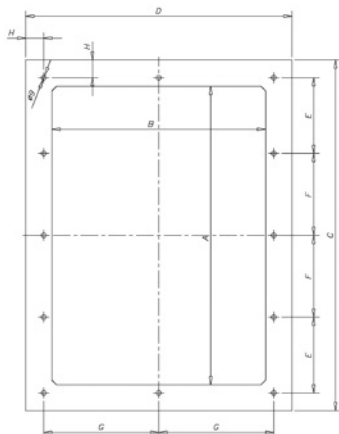

Impulsion flange accessory

	A	B	C	D	E	F	G	H
CSXRT-800	1007	533	1063	589	268.5	250	281.5	13
CSXRT-900	1130	595	1186	651	280	300	312.5	13
CSXRT-1000	1267	663	1323	719	298.5	350	346.5	13

### Dimensions mm

#### CJSXR

##### Standard supply horizontal impulsion (H) RD 90

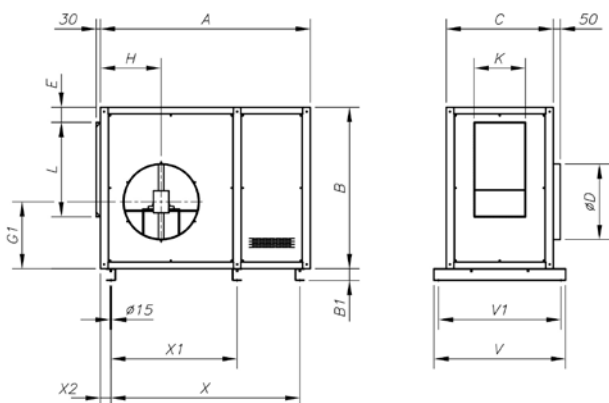

##### Horizontal impulsion on request (H) LG 90

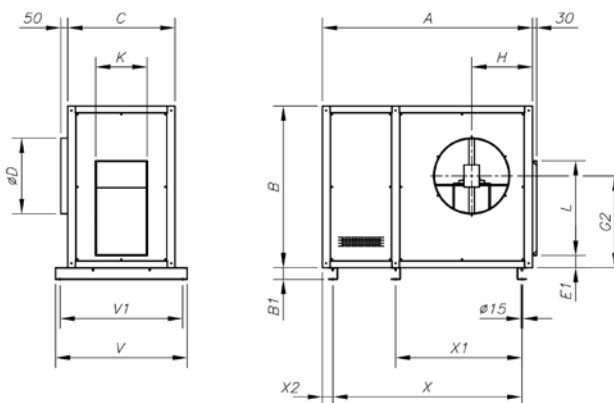

##### Vertical impulsion on request (V) RD 0

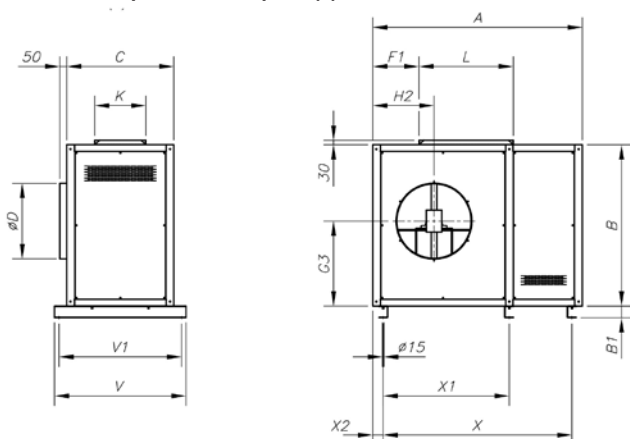

##### Vertical impulsion on request (V) LG 0

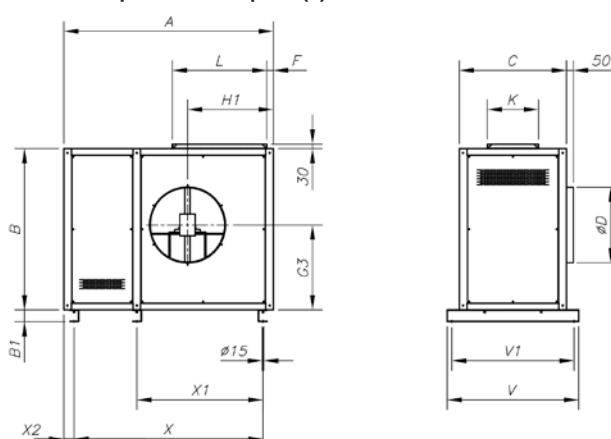

Model	A	B	B1	C	ØD	E	E1	F	F1	G1	G2	G3	H	H1	H2	L	K	V	V1	X	X1	X2
CJSXR-315	1170	740	60	600	315	82	84.2	113	281	317.5	423.2	366.2	305	451.5	346.3	405	224	760	680	880	-	155
CJSXR-355	1265	815	60	650	365	85	86.5	112.5	302.5	347.2	470.2	398	338	496	373	454	248	810	730	1020	-	152
CJSXR-400	1370	900	60	680	400	82	90.2	111	331	386.2	522.2	447.2	359	543	407	508	275	840	760	1120	-	152
CJSXR-450	1480	990	60	716	448	82	91.2	112.8	360	422.2	577.2	491	383	598	443	570	309	876	796	1240	-	152
CJSXR-500	1625	1080	60	760	510	80.5	91	111.7	381.3	461.2	629.2	534.2	409	650	482	639	345	920	840	1340	670	152
CJSXR-560	1760	1195	60	810	580	86.8	94.2	128	426	506.2	696.2	590	462	731	540	716	384	970	890	1490	745	152
CJSXR-630	1880	1322	60	850	635	85.2	89.6	113.4	455.6	557.7	768.7	648.2	488	792.5	578.5	802	433	1010	930	820	1610	158
CJSXR-710	2180	1500	80	910	710	103	108.2	100	491	632.2	873.2	737.2	562	865	624	899	479	1070	990	955	1910	168

**Characteristic curves**

Q= Flow rate in m<sup>3</sup>/h, m<sup>3</sup>/s and cfm.

Pe= Static pressure in mm H<sub>2</sub>O, Pa and inwg.

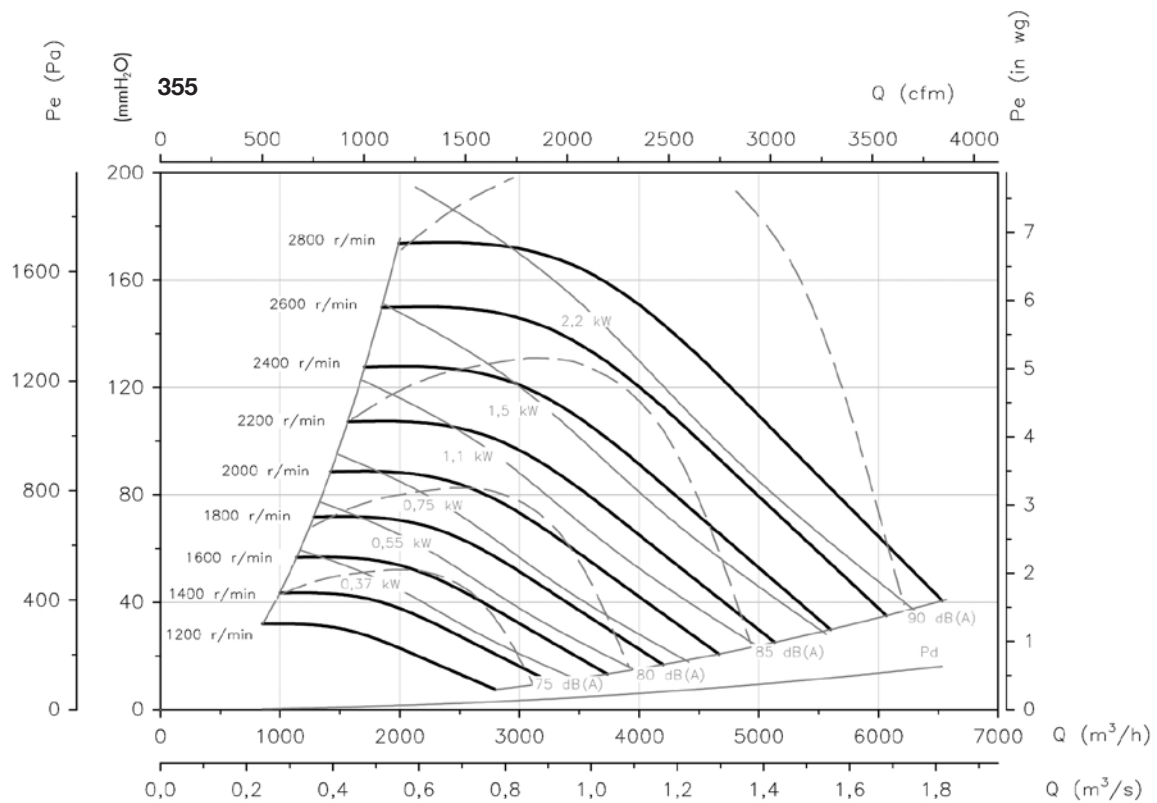
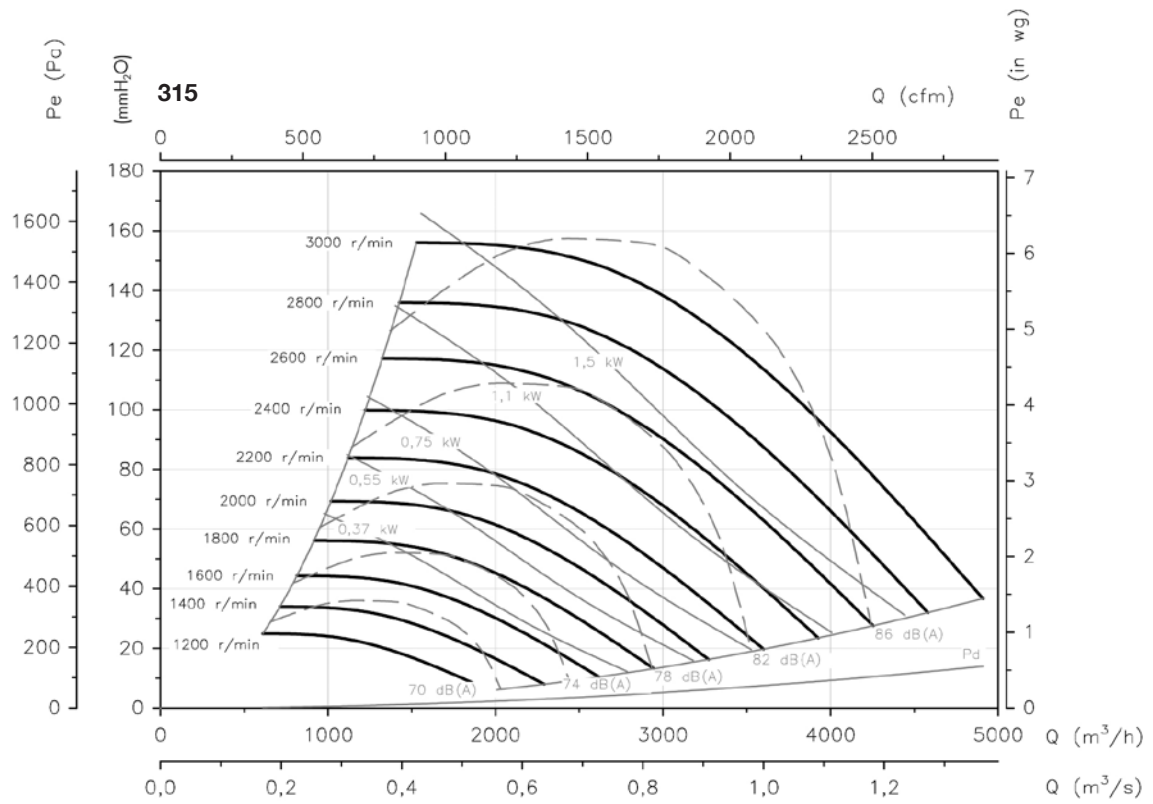

**Characteristic curves**

Q= Flow rate in m<sup>3</sup>/h, m<sup>3</sup>/s and cfm.

Pe= Static pressure in mm H<sub>2</sub>O, Pa and inwg.

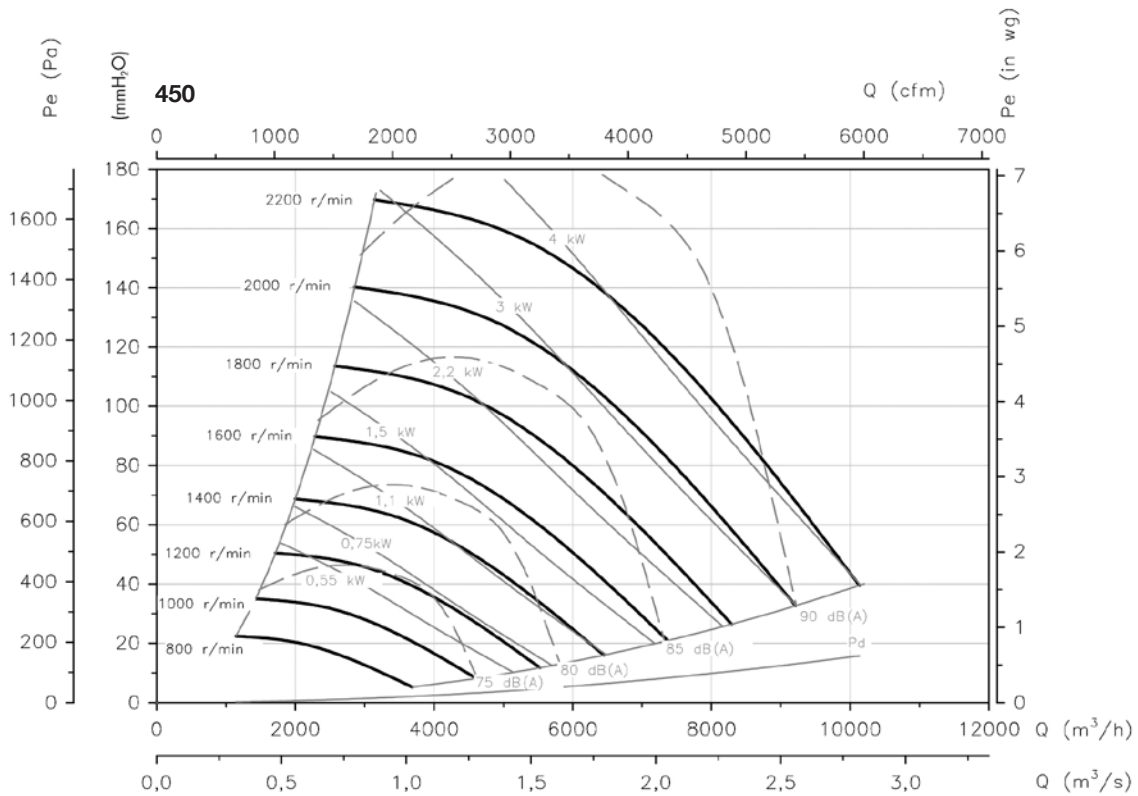
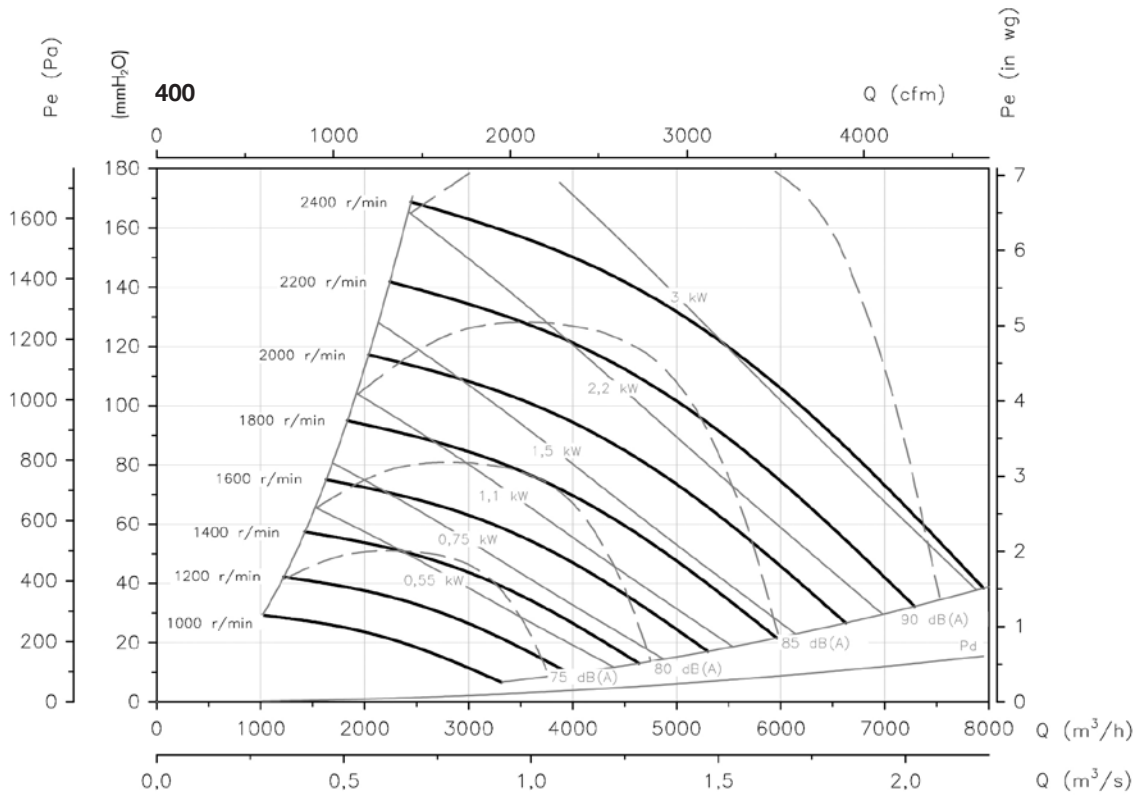



**Characteristic curves**

Q= Flow rate in m<sup>3</sup>/h, m<sup>3</sup>/s and cfm.

Pe= Static pressure in mm H<sub>2</sub>O, Pa and inwg.

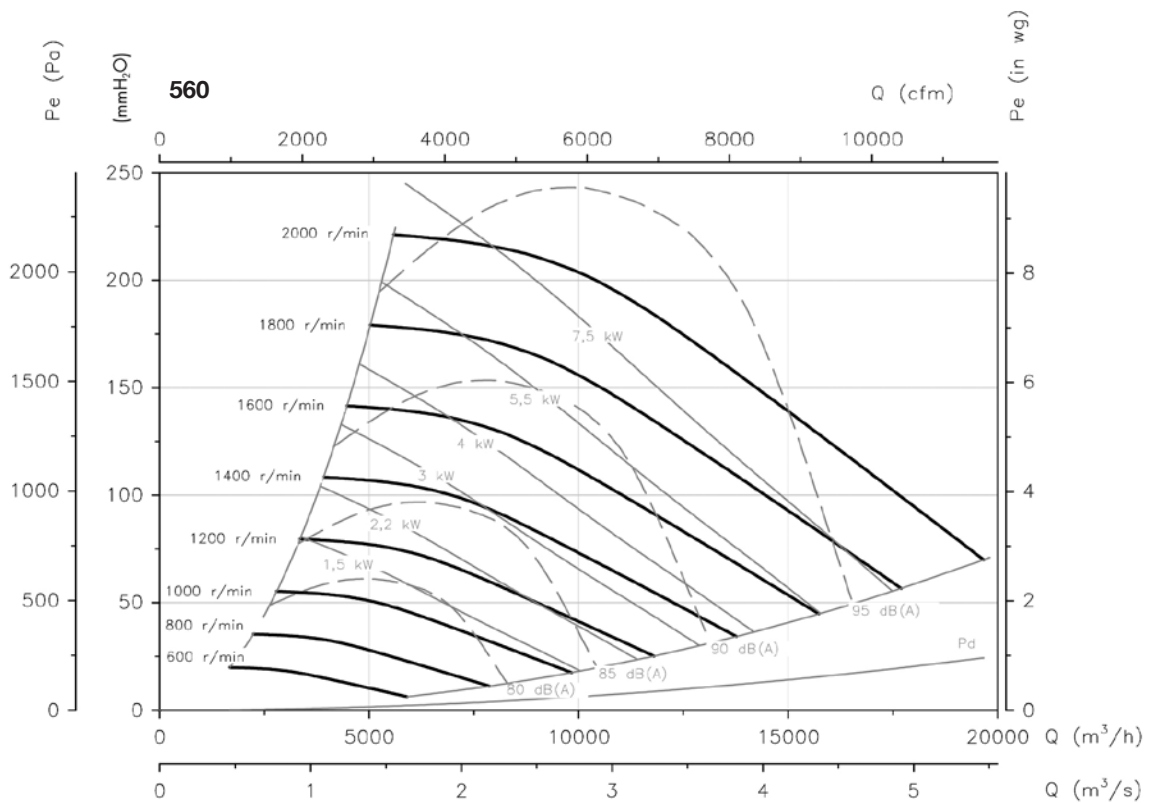
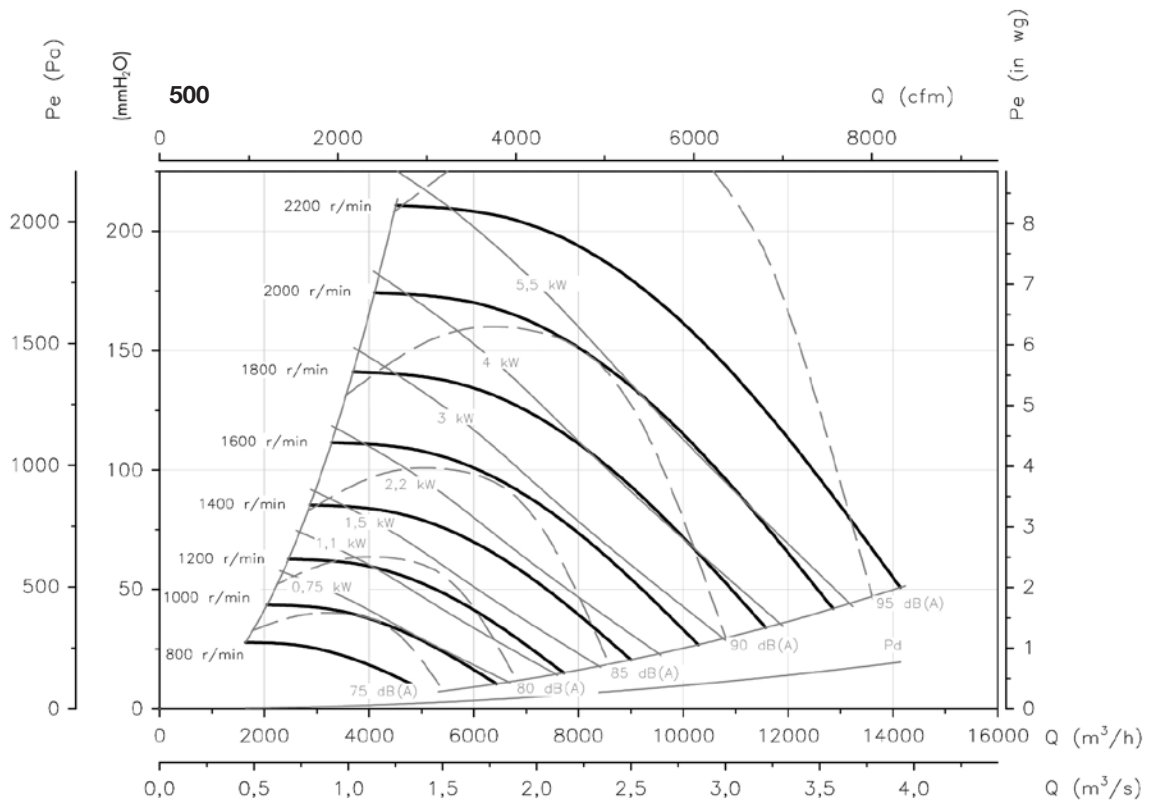

**Characteristic curves**

Q= Flow rate in m<sup>3</sup>/h, m<sup>3</sup>/s and cfm.

Pe= Static pressure in mm H<sub>2</sub>O, Pa and inwg.

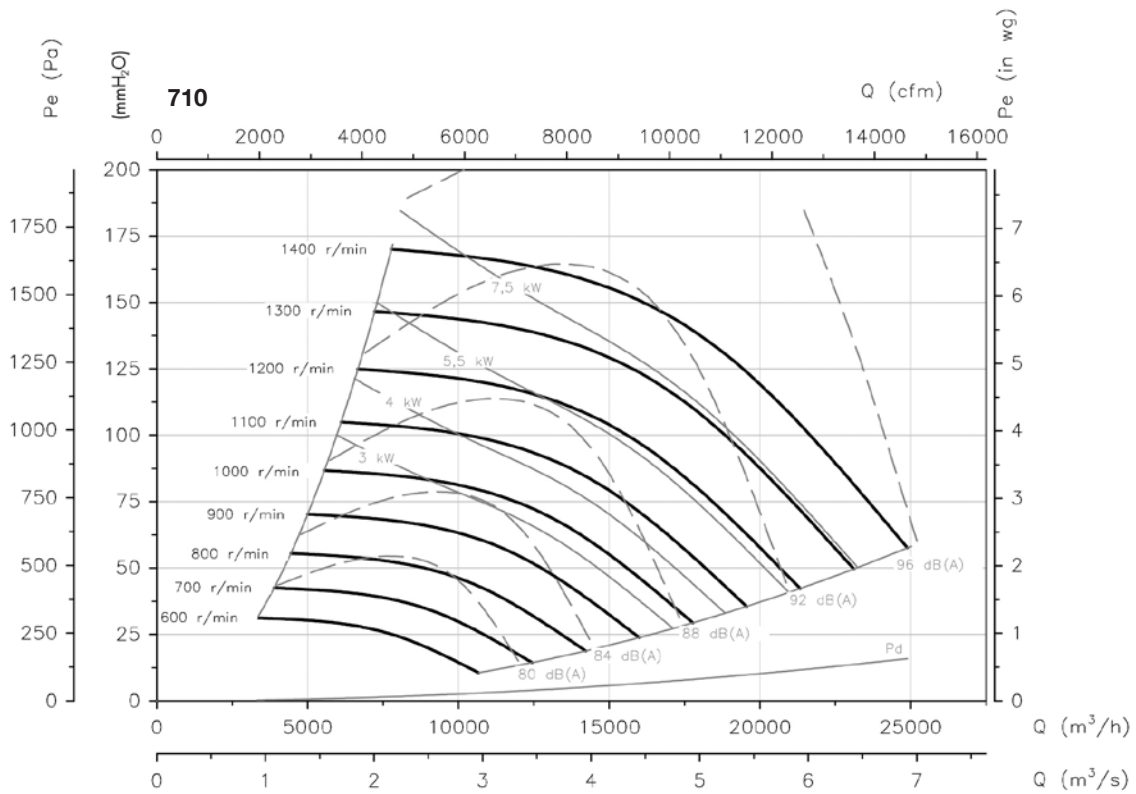
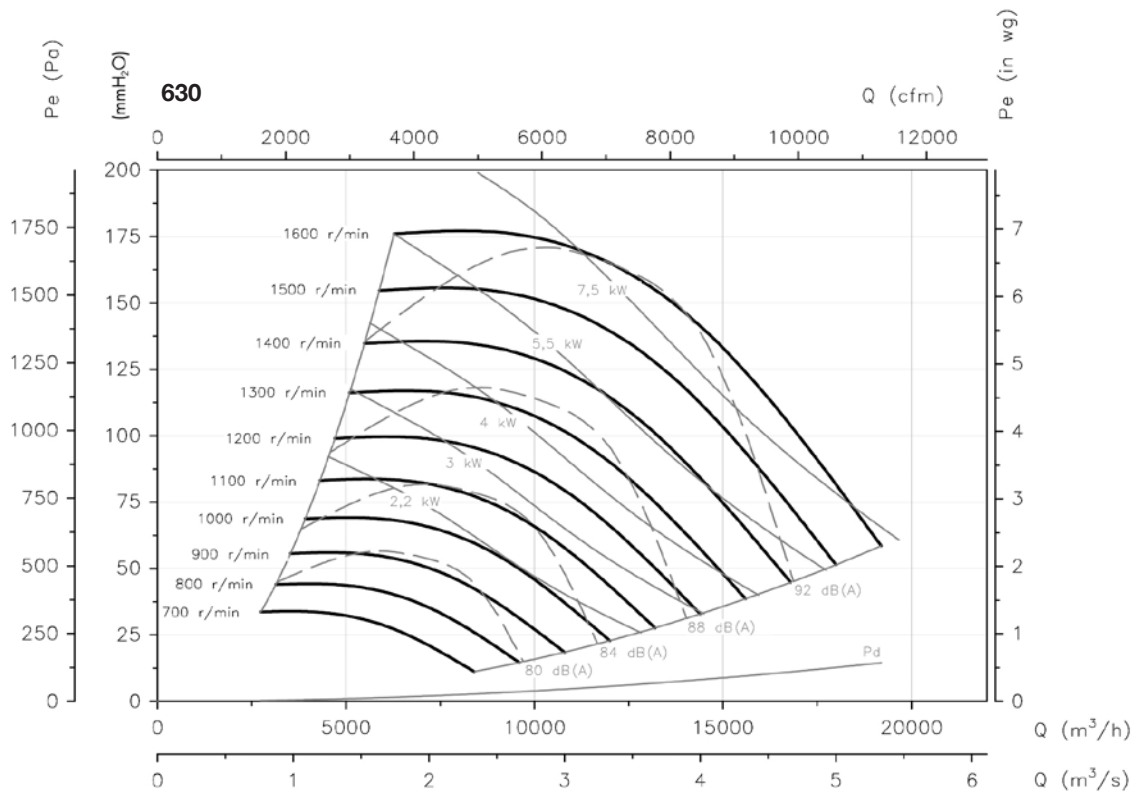

**Characteristic curves**

Q= Flow rate in m<sup>3</sup>/h, m<sup>3</sup>/s and cfm.

Pe= Static pressure in mm H<sub>2</sub>O, Pa and inwg.

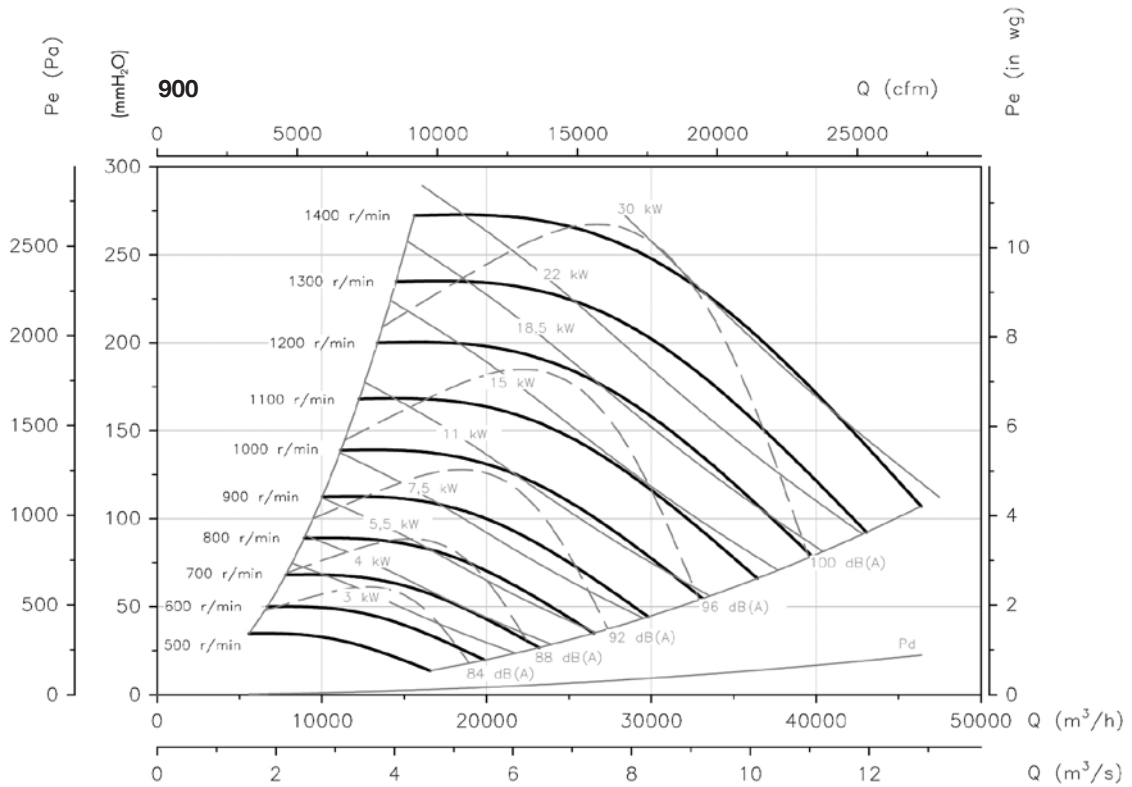
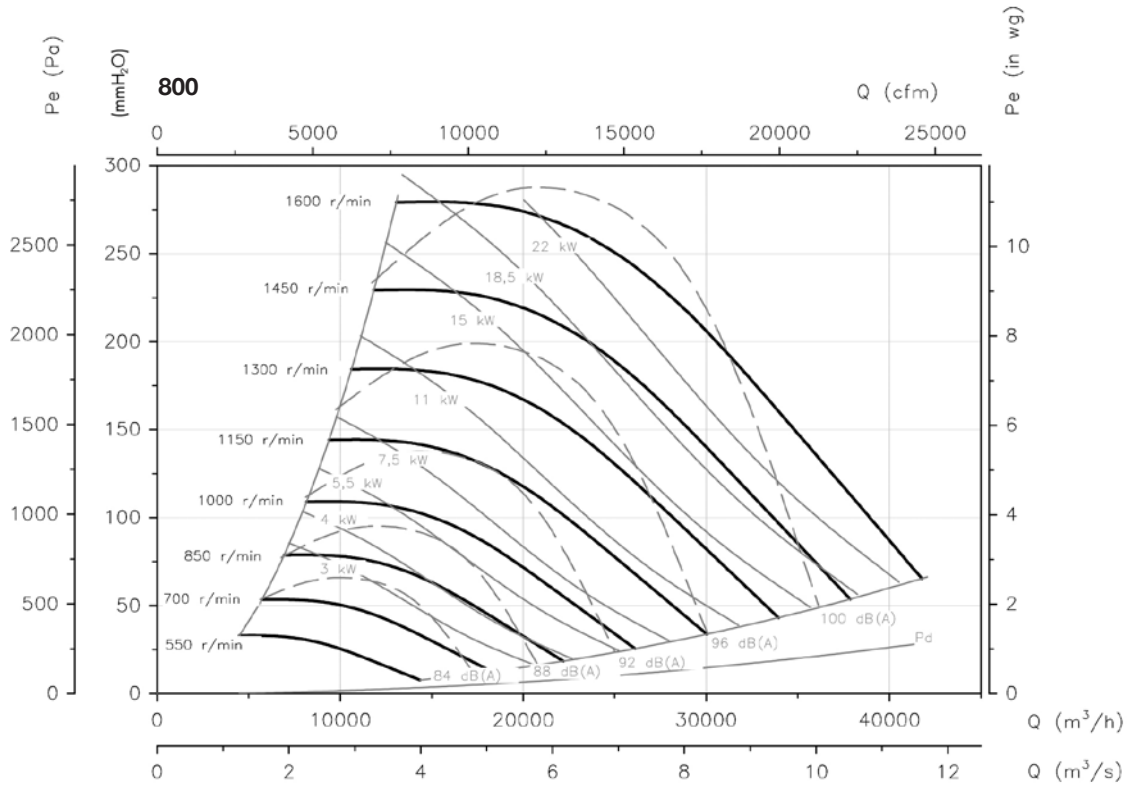

**Characteristic curves**

Q= Flow rate in m<sup>3</sup>/h, m<sup>3</sup>/s and cfm.

Pe= Static pressure in mm H<sub>2</sub>O, Pa and inwg.

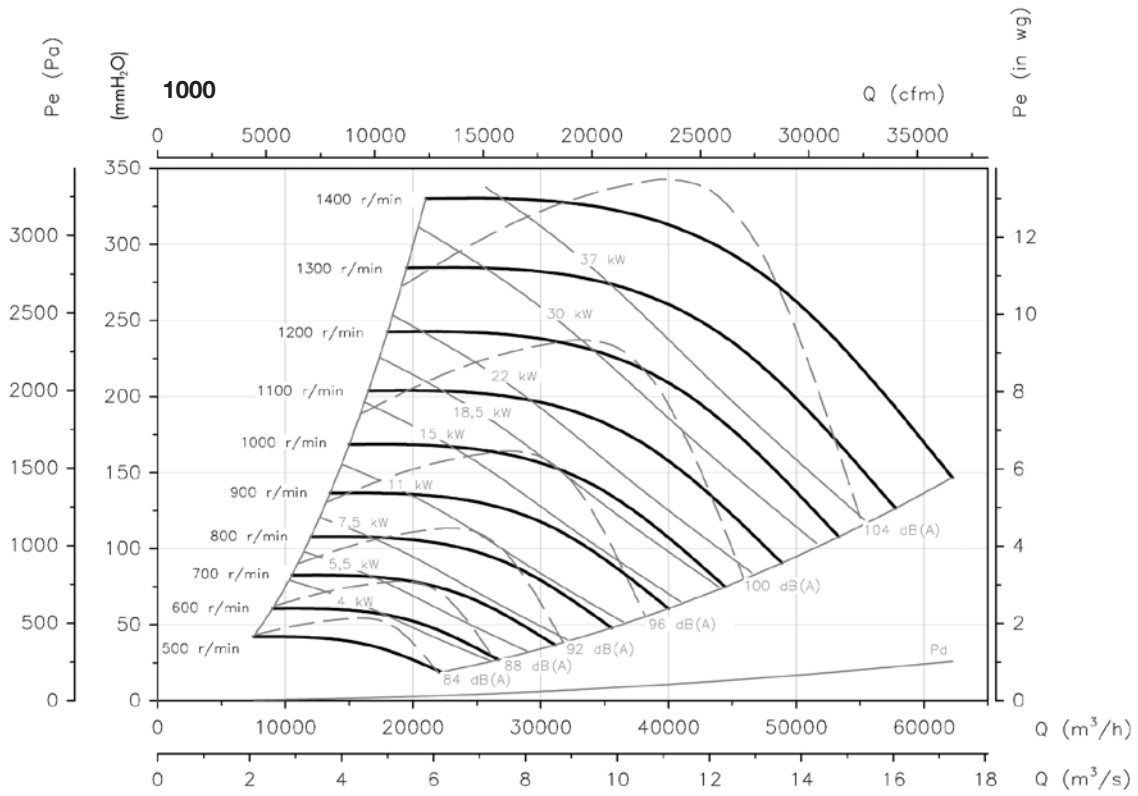

**Accessories**



# TSA TSAT CJTSA

**TSA: Single inlet, belt-driven centrifugal fans with shaft outlet and forward-curved impeller**

**TSAT: Belt-driven, single inlet, centrifugal fans fitted with electric motors, a set of pulleys and belts, protectors and forward-curved impeller**

**CJTSA: Ventilation units with forward-curved impeller, acoustic insulation, fitted with fans from the TSA series, resting on rubber shock-absorbers**



TSA



TSAT



CJTSA

**Fan:**

- Galvanised sheet steel casing.
- Impeller with forward-curved reaction blades made of galvanised sheet steel.
- Galvanised sheet steel structure with thermal and acoustic insulation (CJTSA).
- Cable gland for cable entry (CJTSA).

**Motor:**

- IE3 efficiency motors for powers equal to or greater than 0.75kW except single-phase, 2-speed and 8-pole.
- Class F motors with ball bearings and IP55 protection.
- Multi voltage motor, special design valid for 220/380V 60Hz, 254/440V 60Hz, 265/460V 60Hz, 277/480V 60Hz.
- Maximum temperature of air to be carried: -20 °C. +60 °C.

**Finish:**

- Anti-corrosive finished galvanised sheet steel.

**On request:**

- Different impulsion nozzle positions.
- Special windings for different voltages.
- With 2-speed motors.

**Order code**

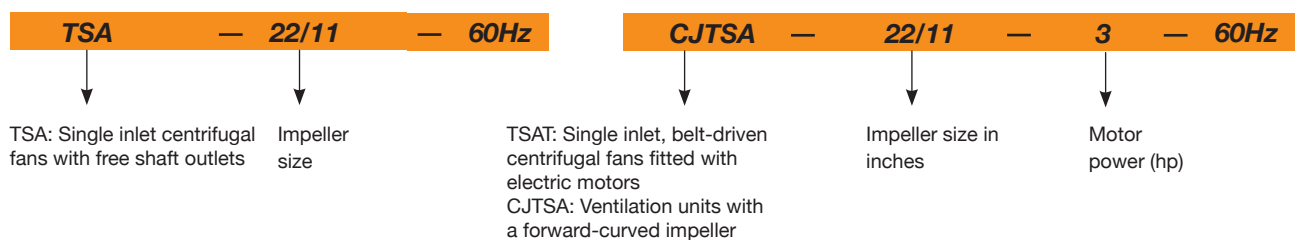

**Technical characteristics**

60Hz

Model	Max. speed (r/min)	Max. installed power (kW)	Maximum flow rate (m³/h)	Air temperature min. (°C)	Air temperature max. (°C)	Approx. weight (kg)
TSA-12/6	1500	2.2	4800	-20	85	17.5
TSA-15/7	1050	3	7400	-20	85	22.5
TSA-18/9	920	4	10500	-20	85	33
TSA-20/10	850	5.5	15000	-20	85	71
TSA-22/11	1000	18.5	26000	-20	85	80
TSA-25/13	810	18.5	32000	-20	85	93
TSA-30/14	600	18.5	38000	-20	85	125

### Technical characteristics

Model			Speed (r/min)	Max. admissible current (A)		Installed power (kW)	Maximum flow rate (m <sup>3</sup> /h)	Sound pres- sure level dB(A)	Approx. weight (kg)
				220-277V	380-480V				
TSAT	CJTSA	12/6-0.75	1000	2.4	1.4	0.55	2600	69	73
TSAT	CJTSA	12/6-1	1100	3.3	1.9	0.75	3100	71	74
TSAT	CJTSA	12/6-1.5	1250	4.5	2.6	1.1	3500	74	77
TSAT	CJTSA	12/6-2	1300	6.0	3.5	1.5	4250	77	80
TSAT	CJTSA	12/6-3	1500	8.3	4.8	2.2	4800	79	85
TSAT	CJTSA	15/7-1	800	3.3	1.9	0.75	4000	67	92
TSAT	CJTSA	15/7-1.5	850	4.5	2.6	1.1	4800	69	95
TSAT	CJTSA	15/7-2	920	6.0	3.5	1.5	5400	72	98
TSAT	CJTSA	15/7-3	1000	8.3	4.8	2.2	6400	75	103
TSAT	CJTSA	15/7-4	1050	11.2	6.5	3	7400	77	106
TSAT	CJTSA	18/9-1.5	750	4.5	2.6	1.1	5800	68	111
TSAT	CJTSA	18/9-2	790	6.0	3.5	1.5	6600	70	114
TSAT	CJTSA	18/9-3	800	8.3	4.8	2.2	8200	74	119
TSAT	CJTSA	18/9-4	850	11.2	6.5	3	9000	76	122
TSAT	CJTSA	18/9-5.5	920	14.9	8.6	4	10500	78	125
TSAT	CJTSA	20/10-2	650	6.0	3.5	1.5	8100	65	203
TSAT	CJTSA	20/10-3	690	8.3	4.8	2.2	10100	68	208
TSAT	CJTSA	20/10-4	750	11.2	6.5	3	11500	70	211
TSAT	CJTSA	20/10-5.5	790	14.9	8.6	4	13100	73	214
TSAT	CJTSA	20/10-7.5	850		11.1	5.5	15000	75	227
TSAT	CJTSA	22/11-3	580	8.3	4.8	2.2	11200	67	219
TSAT	CJTSA	22/11-4	610	11.2	6.5	3	13000	70	222
TSAT	CJTSA	22/11-5.5	650	14.9	8.6	4	15000	72	225
TSAT	CJTSA	22/11-7.5	690		11.1	5.5	17000	74	238
TSAT	CJTSA	22/11-10	750		14.8	7.5	19000	76	246
TSAT	CJTSA	22/11-12.5	790		17.8	9.2	21000	78	257
TSAT	CJTSA	22/11-15	830		21.5	11	22000	79	273
TSAT	CJTSA	22/11-20	910		28.5	15	24500	81	292
TSAT	CJTSA	22/11-25	1000		35.0	18.5	26000	83	322
TSAT	CJTSA	25/13-4	520	11.2	6.5	3	14000	62	254
TSAT	CJTSA	25/13-5.5	550	14.9	8.6	4	17000	65	257
TSAT	CJTSA	25/13-7.5	590		11.1	5.5	19500	67	270
TSAT	CJTSA	25/13-10	620		14.8	7.5	23000	70	278
TSAT	CJTSA	25/13-12.5	650		17.8	9.2	25000	72	289
TSAT	CJTSA	25/13-15	690		21.5	11	26500	74	305
TSAT	CJTSA	25/13-20	750		28.5	15	29500	75	324
TSAT	CJTSA	25/13-25	810		35.0	18.5	32000	77	354
TSAT	CJTSA	30/14-5.5	400	14.9	8.6	4	21000	69	331
TSAT	CJTSA	30/14-7.5	425		11.1	5.5	24000	72	344
TSAT	CJTSA	30/14-10	460		14.8	7.5	27500	74	352
TSAT	CJTSA	30/14-12.5	480		17.8	9.2	30000	76	363
TSAT	CJTSA	30/14-15	500		21.5	11	33000	77	379
TSAT	CJTSA	30/14-20	550		28.5	15	36500	78	398
TSAT	CJTSA	30/14-25	600		35.0	18.5	38000	81	428

### Dimensions mm

#### TSA

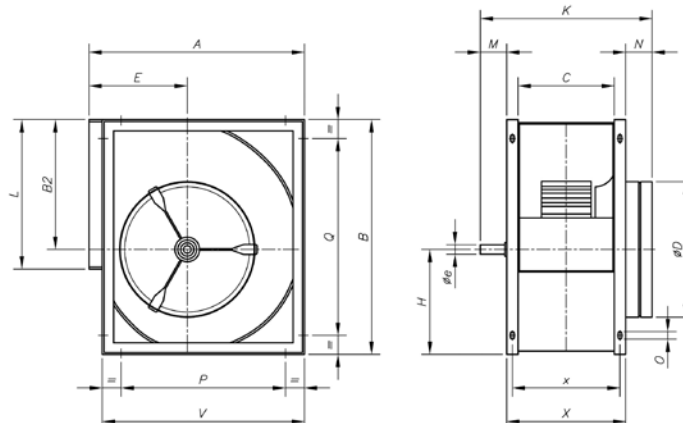

Model	A	B	B2	C	øD	E	øe	H	K	L	M	N	O	P	Q	V	X	x
TSA-12/6	498	532	290	210	325	230	25	242	435	345	75	90	9x17	324	324	468	270	242
TSA-15/7	583	632	348	269	400	265	25	284	494	404	75	90	9x17	406	406	553	329	301
TSA-18/9	694	756	415	301	475	323	25	341	526	482	75	90	9x17	520	608	664	361	333

Dimensions mm

TSA

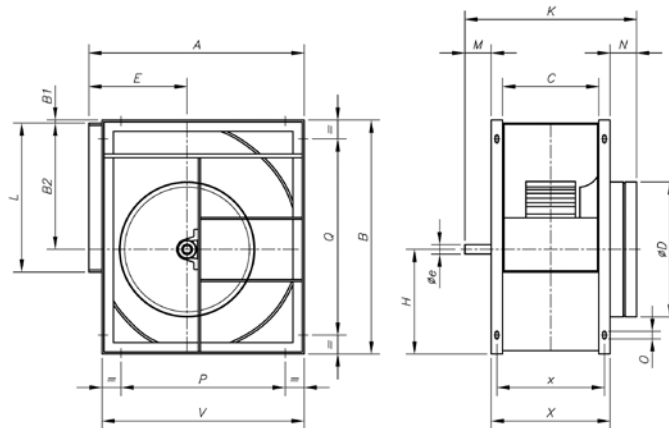

Model	A	B	B1	B2	C	øD	E	øe	H	K	L	M	N	O	P	Q	V	X	x
TSA-20/10	843	963	35	523	330	575	375	35	440	620	603	100	110	9x17	646	811	798	410	370
TSA-22/11	913	1046	35	569	358	615	400	35	477	648	693	100	110	9x17	716	894	868	438	398
TSA-25/13	998	1161	35	642	412	695	423	35	519	701	793	100	110	9x17	801	1009	953	492	452
TSA-30/14	1206	1400	35	776	474	835	515	40	624	764	933	100	110	9x17	1009	1248	1161	554	514

TSAT

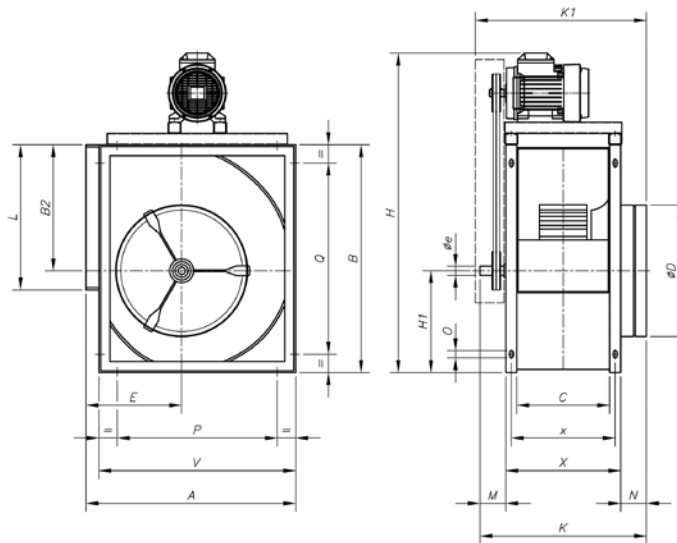

Model	A	B	B2	C	øD	E	øe	H	H1	K	K1	L	M	N	O	P	Q	V	X	x
TSAT-12/6-0.75	498	532	290	210	325	230	25	805	242	435	475	345	75	90	9x17	324	324	468	270	242
TSAT-12/6-1	498	532	290	210	325	230	25	805	242	435	475	345	75	90	9x17	324	324	468	270	242
TSAT-12/6-1.5	498	532	290	210	325	230	25	825	242	435	475	345	75	90	9x17	324	324	468	270	242
TSAT-12/6-2	498	532	290	210	325	230	25	825	242	435	475	345	75	90	9x17	324	324	468	270	242
TSAT-12/6-3	498	532	290	210	325	230	25	845	242	435	475	345	75	90	9x17	324	324	468	270	242
TSAT-15/7-1	583	632	348	269	400	265	25	905	284	494	535	404	75	90	9x17	406	406	553	329	301
TSAT-15/7-1.5	583	632	348	269	400	265	25	925	284	494	535	404	75	90	9x17	406	406	553	329	301
TSAT-15/7-2	583	632	348	269	400	265	25	925	284	494	535	404	75	90	9x17	406	406	553	329	301
TSAT-15/7-3	583	632	348	269	400	265	25	945	284	494	535	404	75	90	9x17	406	406	553	329	301
TSAT-15/7-4	583	632	348	269	400	265	25	945	284	494	535	404	75	90	9x17	406	406	553	329	301
TSAT-18/9-1.5	694	756	415	301	475	323	25	1050	341	526	566	482	75	90	9x17	520	608	664	361	333
TSAT-18/9-2	694	756	415	301	475	323	25	1050	341	526	566	482	75	90	9x17	520	608	664	361	333
TSAT-18/9-3	694	756	415	301	475	323	25	1070	341	526	566	482	75	90	9x17	520	608	664	361	333
TSAT-18/9-4	694	756	415	301	475	323	25	1070	341	526	566	482	75	90	9x17	520	608	664	361	333
TSAT-18/9-5.5	694	756	415	301	475	323	25	1095	341	526	566	482	75	90	9x17	520	608	664	361	333

### Dimensions mm

#### TSAT

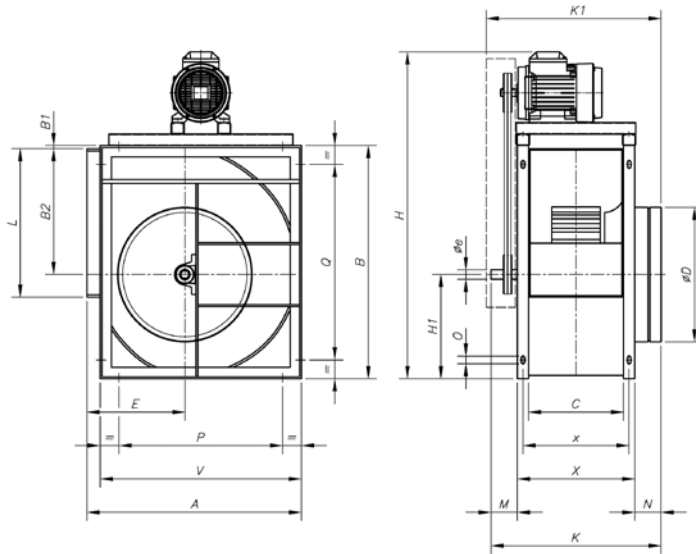

Model	A	B	B1	B2	C	øD	E	øe	H	H1	K	K1	L	M	N	O	P	Q	V	X	x
TSAT-20/10-2	843	963	35	523	330	575	375	35	1255	440	620	670	603	100	110	9x17	646	811	798	410	370
TSAT-20/10-3	843	963	35	523	330	575	375	35	1275	440	620	670	603	100	110	9x17	646	811	798	410	370
TSAT-20/10-4	843	963	35	523	330	575	375	35	1275	440	620	670	603	100	110	9x17	646	811	798	410	370
TSAT-20/10-5.5	843	963	35	523	330	575	375	35	1300	440	620	670	603	100	110	9x17	646	811	798	410	370
TSAT-20/10-7.5	843	963	35	523	330	575	375	35	1340	440	620	670	603	100	110	9x17	646	811	798	410	370
TSAT-22/11-3	913	1046	35	569	358	615	400	35	1355	477	648	700	693	100	110	9x17	716	894	868	438	398
TSAT-22/11-4	913	1046	35	569	358	615	400	35	1355	477	648	700	693	100	110	9x17	716	894	868	438	398
TSAT-22/11-5.5	913	1046	35	569	358	615	400	35	1280	477	648	700	693	100	110	9x17	716	894	868	438	398
TSAT-22/11-7.5	913	1046	35	569	358	615	400	35	1420	477	648	700	693	100	110	9x17	716	894	868	438	398
TSAT-22/11-10	913	1046	35	569	358	615	400	35	1420	477	648	700	693	100	110	9x17	716	894	868	438	398
TSAT-22/11-12.5	913	1046	35	569	358	615	400	35	1420	477	648	700	693	100	110	9x17	716	894	868	438	398
TSAT-22/11-15	913	1046	35	569	358	615	400	35	1480	477	648	700	693	100	110	9x17	716	894	868	438	398
TSAT-22/11-20	913	1046	35	569	358	615	400	35	1480	477	648	700	693	100	110	9x17	716	894	868	438	398
TSAT-22/11-25	913	1046	35	569	358	615	400	35	1565	477	648	700	693	100	110	9x17	716	894	868	438	398
TSAT-25/13-4	998	1161	35	642	412	695	423	35	1470	519	701	750	793	100	110	9x17	801	1009	953	492	452
TSAT-25/13-5.5	998	1161	35	642	412	695	423	35	1495	519	701	750	793	100	110	9x17	801	1009	953	492	452
TSAT-25/13-7.5	998	1161	35	642	412	695	423	35	1540	519	701	750	793	100	110	9x17	801	1009	953	492	452
TSAT-25/13-10	998	1161	35	642	412	695	423	35	1540	519	701	750	793	100	110	9x17	801	1009	953	492	452
TSAT-25/13-12.5	998	1161	35	642	412	695	423	35	1540	519	701	750	793	100	110	9x17	801	1009	953	492	452
TSAT-25/13-15	998	1161	35	642	412	695	423	35	1565	519	701	750	793	100	110	9x17	801	1009	953	492	452
TSAT-25/13-20	998	1161	35	642	412	695	423	35	1565	519	701	750	793	100	110	9x17	801	1009	953	492	452
TSAT-25/13-25	998	1161	35	642	412	695	423	35	1680	519	701	750	793	100	110	9x17	801	1009	953	492	452
TSAT-30/14-5.5	1206	1400	35	776	474	835	515	40	1735	624	764	815	933	100	110	9x17	1009	1248	1161	554	514
TSAT-30/14-7.5	1206	1400	35	776	474	835	515	40	1775	624	764	815	933	100	110	9x17	1009	1248	1161	554	514
TSAT-30/14-10	1206	1400	35	776	474	835	515	40	1775	624	764	815	933	100	110	9x17	1009	1248	1161	554	514
TSAT-30/14-12.5	1206	1400	35	776	474	835	515	40	1775	624	764	815	933	100	110	9x17	1009	1248	1161	554	514
TSAT-30/14-15	1206	1400	35	776	474	835	515	40	1835	624	764	815	933	100	110	9x17	1009	1248	1161	554	514
TSAT-30/14-20	1206	1400	35	776	474	835	515	40	1835	624	764	815	933	100	110	9x17	1009	1248	1161	554	514
TSAT-30/14-25	1206	1400	35	776	474	835	515	40	1925	624	764	815	933	100	110	9x17	1009	1248	1161	554	514



Dimensions mm

CJTSA

Standard supply horizontal impulsion (H) RD-90

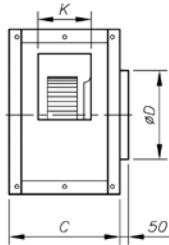
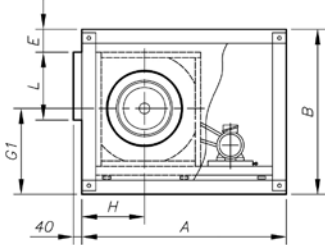

Vertical impulsion on request (V) RD-0

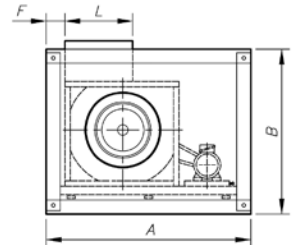
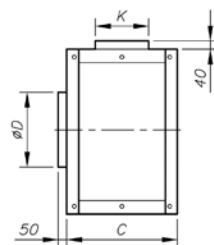

Horizontal impulsion on request (H) LG-90

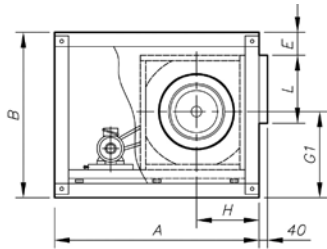
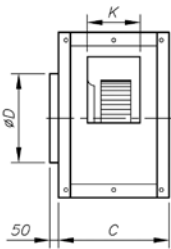

Vertical impulsion on request (V) LG-0

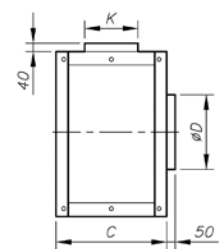
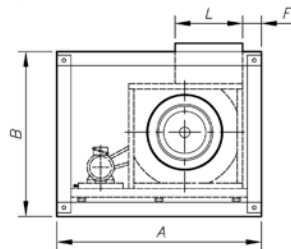

Model	A	B	C	ØD	E	with bench		G1	G1	H	L	L	K
						E	F						
CJTSA-12/6-H	850	650	540	330	74	-	-	288	-	288	346	-	210
CJTSA-12/6-V	850	650	540	330	-	-	30	318	-	328	346	-	210
CJTSA-15/7-H	1000	755	600	400	74	-	-	328	-	328	411	-	270
CJTSA-15/7-V	1000	755	600	400	-	-	30	378	-	383	411	-	270
CJTSA-18/9-H	1200	875	620	480	74	-	-	383	-	388	491	-	305
CJTSA-18/9-V	1200	875	620	480	-	-	30	433	-	448	491	-	305
CJTSA-20/10-H	1485	1175	730	565	175	120	-	475	530	440	613	605	343
CJTSA-20/10-V	1485	1175	730	565	-	-	75	535	-	585	613	-	343
CJTSA-22/11-H	1570	1250	760	615	165	110	-	510	565	470	708	700	373
CJTSA-22/11-V	1570	1250	760	615	-	-	75	570	-	640	708	-	373
CJTSA-25/13-H	1610	1375	820	685	175	120	-	550	605	495	803	795	423
CJTSA-25/13-V	1610	1375	820	685	-	-	75	625	-	705	803	-	423
CJTSA-30/14-H	1845	1600	855	820	160	95	-	655	710	580	943	935	488
CJTSA-30/14-V	1845	1600	855	820	-	-	75	760	-	825	943	-	488

Characteristic curves

Q= Flow rate in m<sup>3</sup>/h, m<sup>3</sup>/s and cfm.

Pe= Static pressure in mm H<sub>2</sub>O, Pa and inwg.

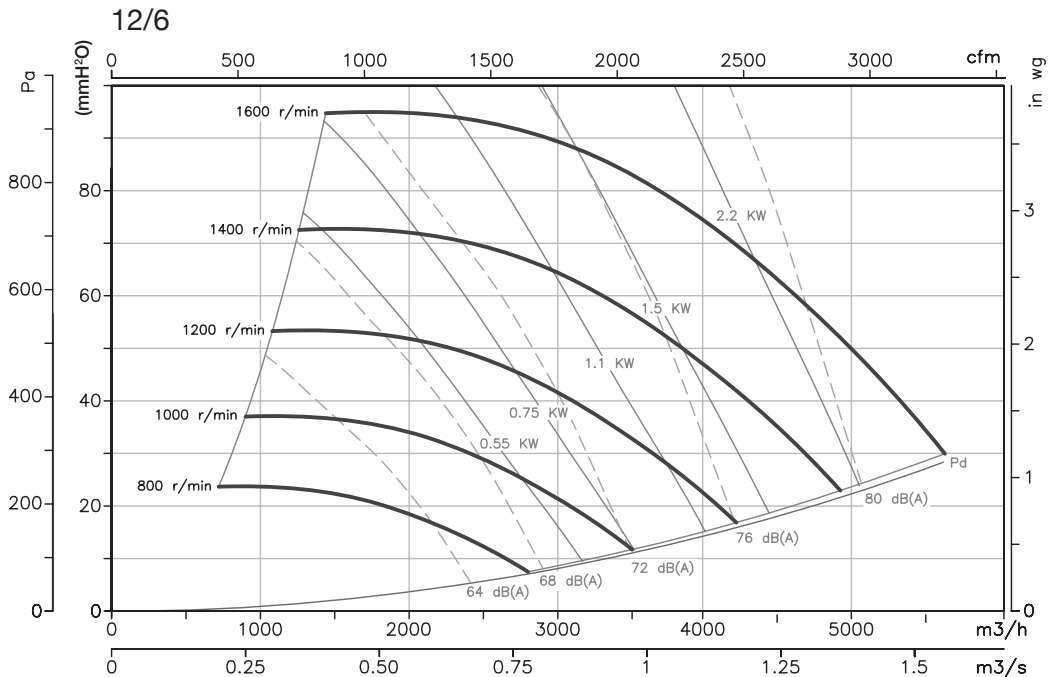

**Characteristic curves**

Q= Flow rate in m<sup>3</sup>/h, m<sup>3</sup>/s and cfm.

Pe= Static pressure in mm H<sub>2</sub>O, Pa and inwg.

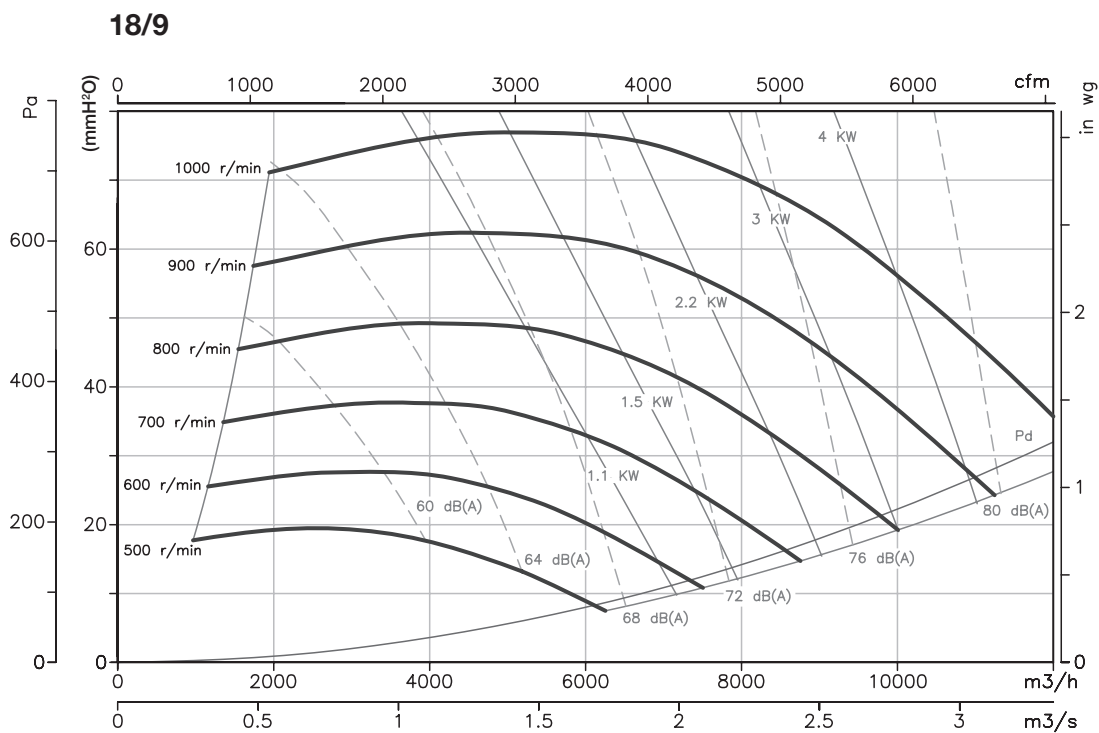
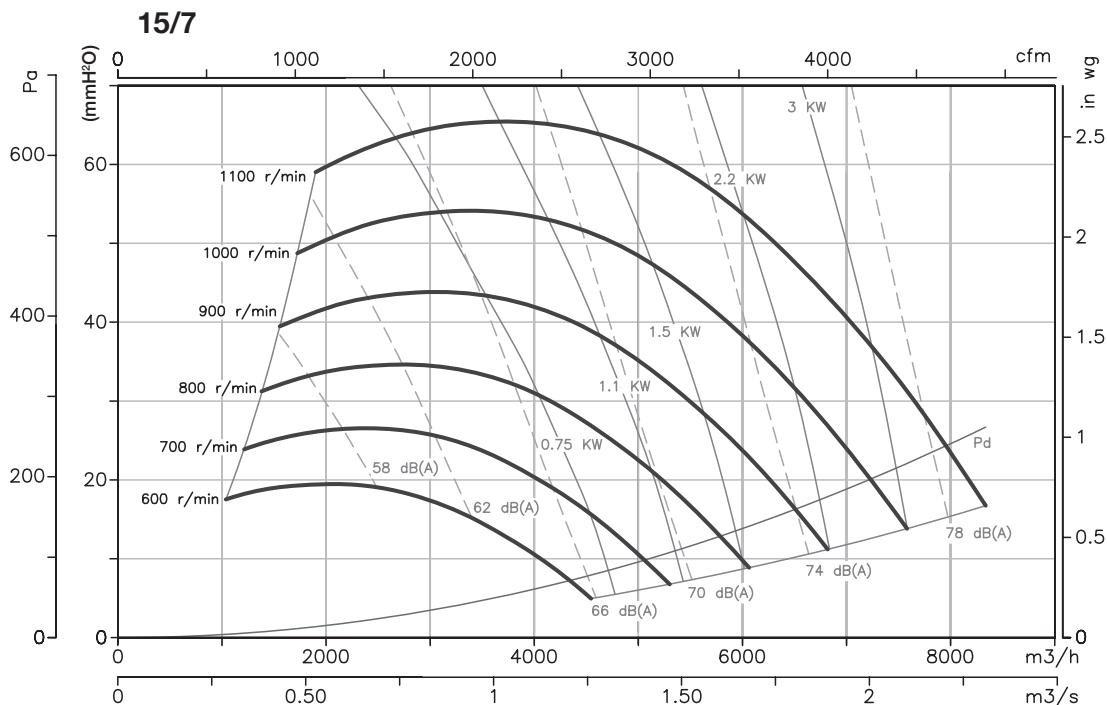

**Characteristic curves**

Q= Flow rate in m<sup>3</sup>/h, m<sup>3</sup>/s and cfm.

Pe= Static pressure in mm H<sup>2</sup>O, Pa and inwg.

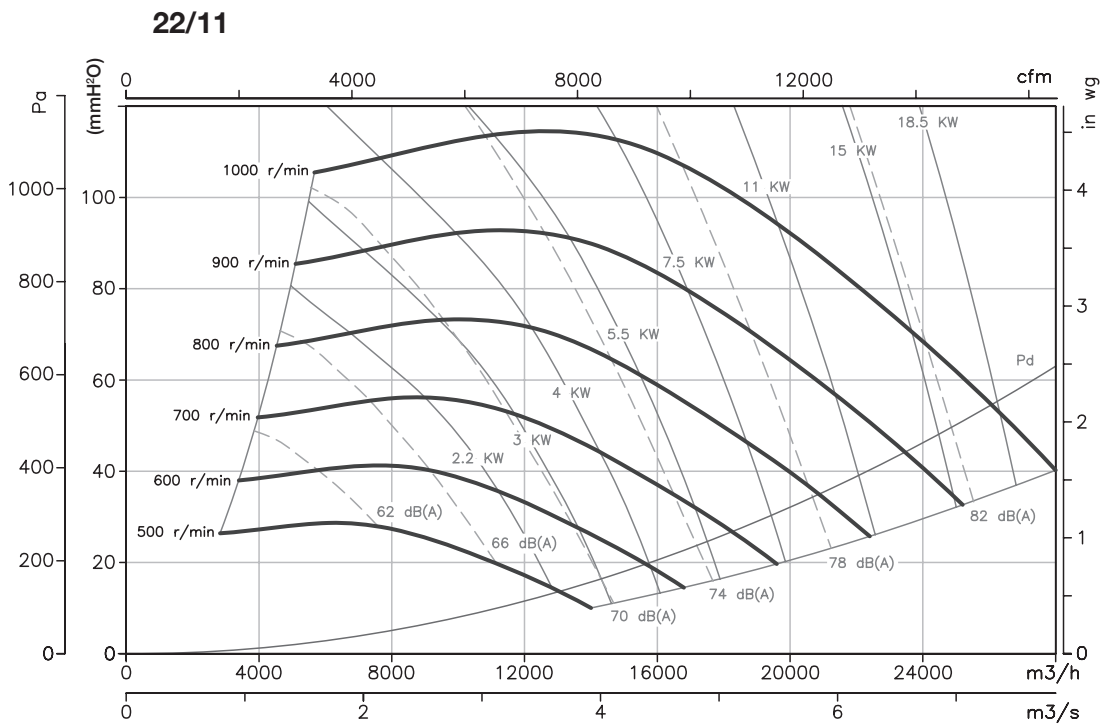
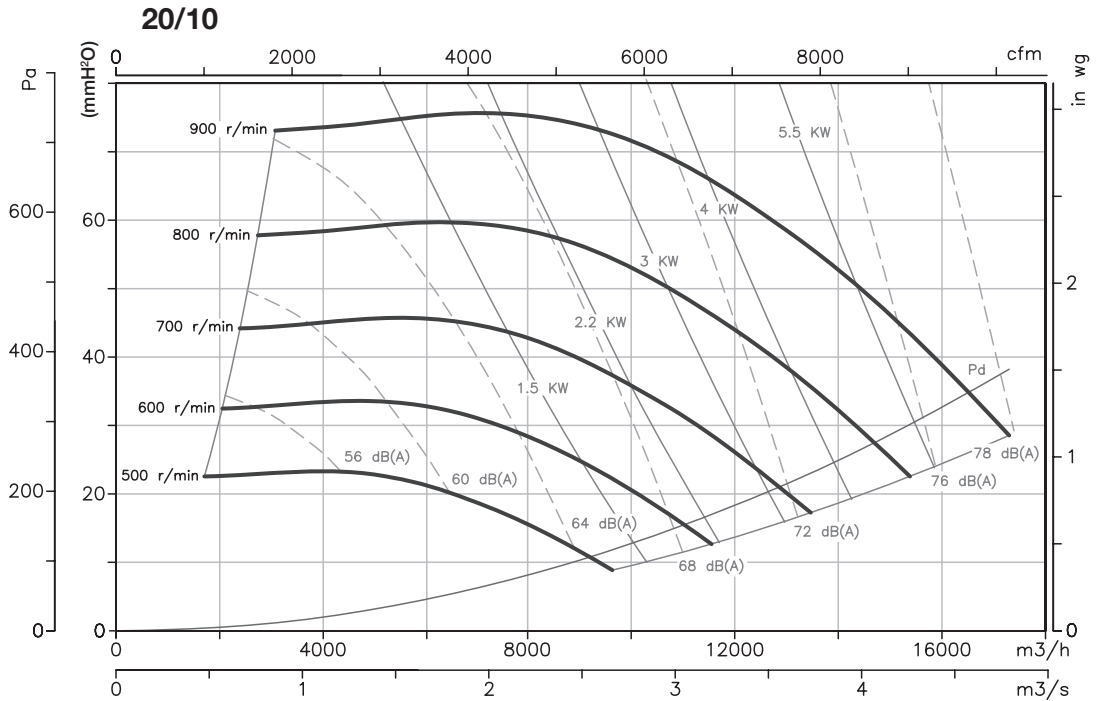

**Characteristic curves**

Q= Flow rate in m<sup>3</sup>/h, m<sup>3</sup>/s and cfm.

Pe= Static pressure in mm H<sup>2</sup>O, Pa and inwg.

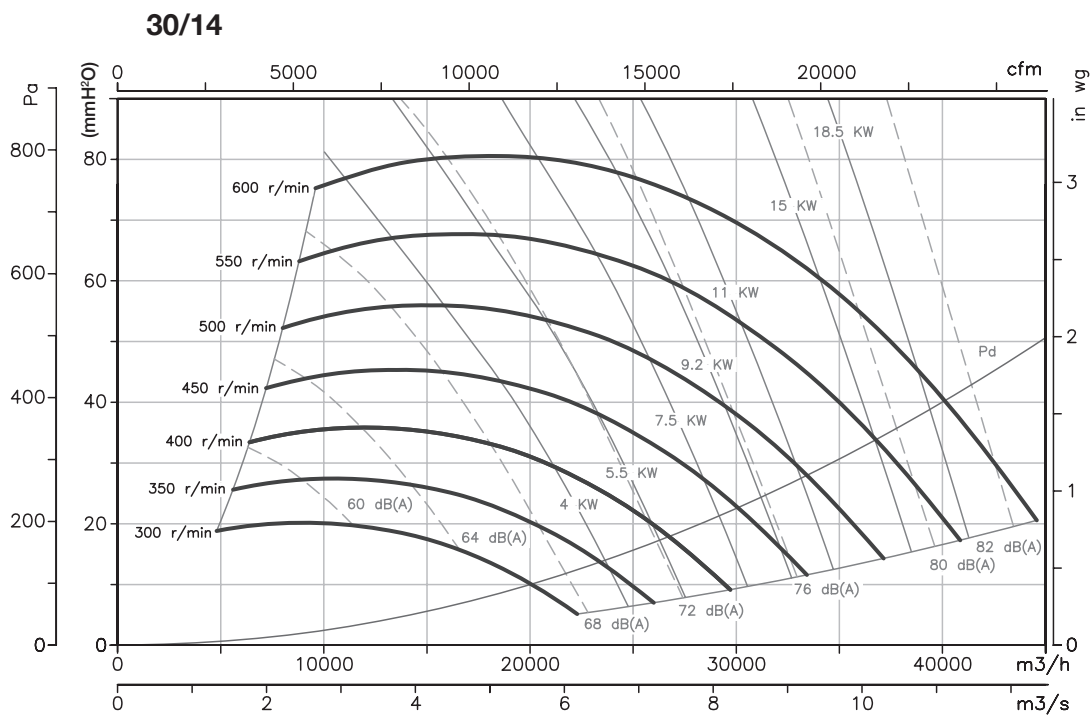
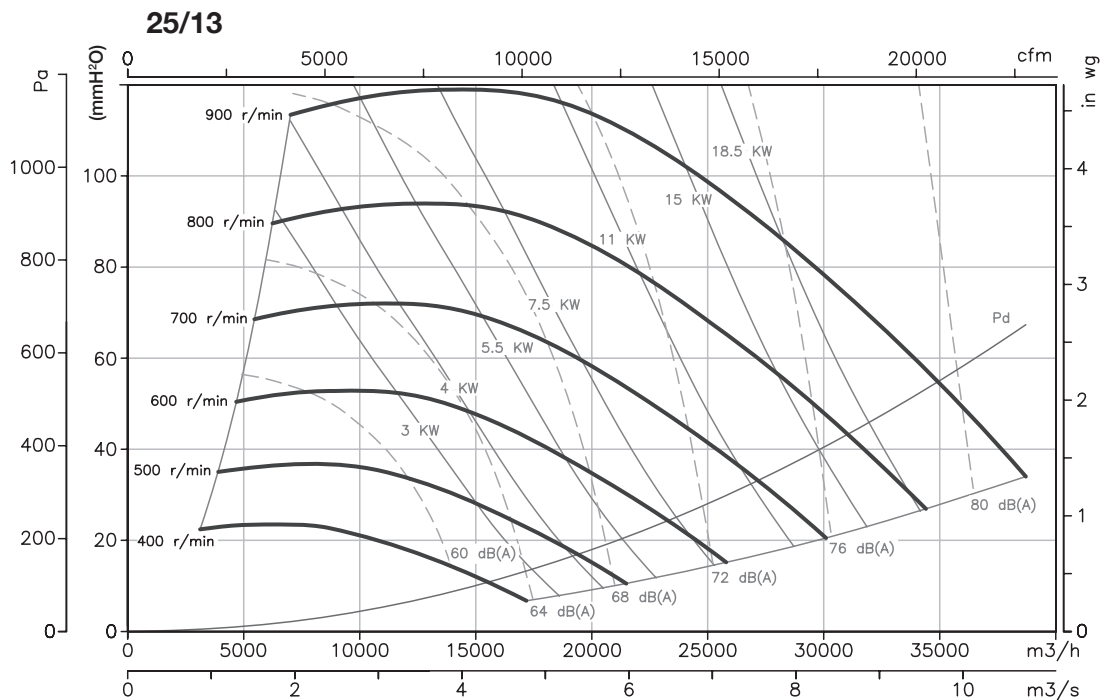

**Accessories**



# CJBR

**Soundproof ventilation units with sandwich-panel and linear airflow between the inlet and outlet.**



Highly-efficient soundproofing

**Fan:**

- Galvanised sheet steel structure with thermal insulation and soundproofing.
- Impeller with backward-curved blades made from galvanised sheet steel
- Outlet mounting on any side of the box possible, during installation

**Motor:**

- IE3 efficiency motors for powers equal to or greater than 0.75kW except single-phase, 2-speed and 8-pole.
- Class F motors with ball bearings, IP55 protection.
- Multi voltage motor, special design valid for 220/380V 60Hz, 254/440V 60Hz, 265/460V 60Hz, 277/480V 60Hz
- Max. air temperature to transport: -20°C.+60°C.

**Finish:**

- Anticorrosive galvanized sheet steel

**On request:**

- With circular outlet via the TAC accessory
- With 2 speed motors

**Order code**

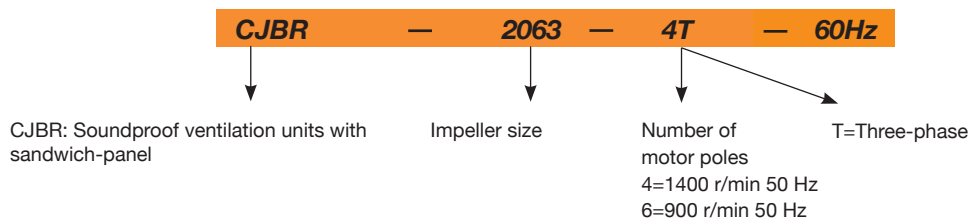

**Technical characteristics**

Model	Speed (r/min)	Maximum admissible current (A)		Installed power (kW)	Maximum airflow m3/h	Sound pressure level dB (A)	Approx. weight (Kg)
		220-277V	380-480V				
CJBR-1240-4T IE3	1704	2,82	1,62	0,75	4250	62	80
CJBR-1850-4T IE3	1728	5,41	3,11	1,50	6700	70	90
CJBR-2056-4T IE3	1722	7,93	4,56	2,20	9500	72	130
CJBR-2056-6T IE3	1128	3,36	1,93	0,75	6500	62	126
CJBR-2263-4T IE3	1758		10,3	5,50	17400	74	202
CJBR-2263-6T IE3	1134	4,68	2,69	1,10	9000	64	141
CJBR-2071-4T IE3	1764		20,9	11,00	25000	83	245
CJBR-2071-6T-3 IE3	1140	9,08	5,22	2,20	12500	68	153
CJBR-2071-6T-5.5 IE3	1152	15,6	8,99	4,00	16000	70	194
CJBR-2880-6T IE3	1152	15,6	8,99	4,00	17100	71	192

**Acoustic features**

The specified values are determined according to free field measurements of sound levels in dB(A) at an equivalent distance of twice the fan's span plus the impeller's diameter, with a minimum of 1.5 m.

Sound power Lw(A) spectrum in dB(A) via frequency band in Hz.

Model	63	125	250	500	1000	2000	4000	8000	Model	63	125	250	500	1000	2000	4000	8000
CJBR-1240-4	47	61	67	70	70	71	61	50	CJBR-2263-6	61	67	72	73	77	76	69	62
CJBR-1850-4	66	72	77	78	81	80	73	68	CJBR-2071-4	80	81	89	92	95	96	92	78
CJBR-2056-4	67	73	79	79	83	83	75	68	CJBR-2071-6-3	65	71	76	77	81	80	73	66
CJBR-2056-6	57	63	69	69	73	73	65	58	CJBR-2071-6-5.5	66	65	80	79	83	83	72	61
CJBR-2263-4	74	79	85	87	85	82	75	67	CJBR-2880-6	68	74	79	80	84	83	76	69

Dimensions in mm

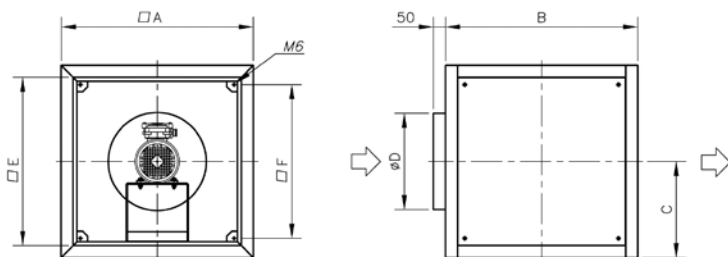

	A	B	C	D	E	F
CJBR-1240	800	800	400	400	700	640
CJBR-1850	800	800	400	400	700	640
CJBR-2056	925	925	462,5	450	825	765
CJBR-2263-4T	1000	1000	500	630	900	840
CJBR-2263-6T	925	925	462,5	560	825	765
CJBR-2071-4T	1060	1060	530	710	960	900
CJBR-2071-6T-3	1000	1000	500	630	900	840
CJBR-2071-6T-5'5	1060	1060	530	710	960	900
CJBR-2880-6T	1060	1060	530	710	960	900

Characteristic curves

Q = Airflow in m<sup>3</sup>/h, m<sup>3</sup>/s and cfm.

Pe = Static pressure in mmH<sub>2</sub>O, Pa and inwg.

Accessories

See accessories section.

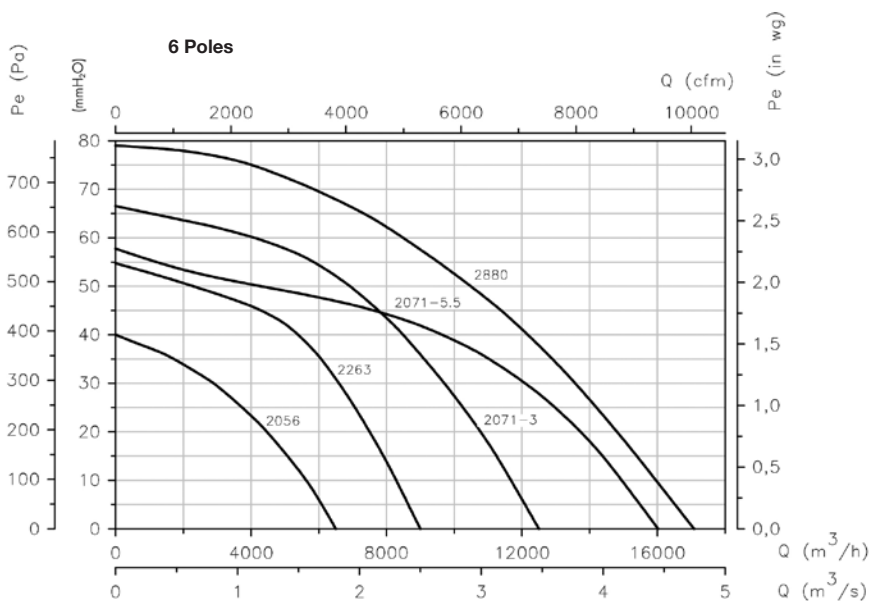
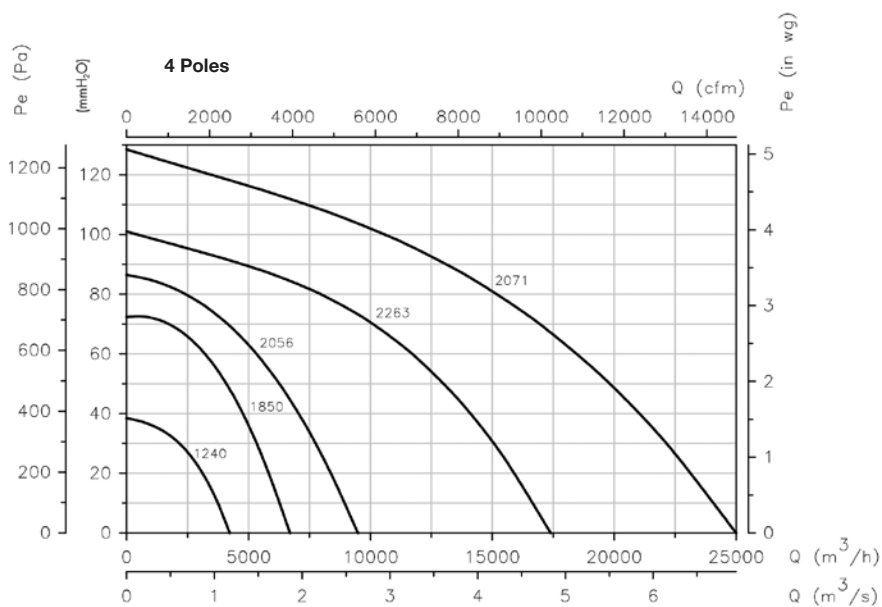

# CMP

## Medium pressure, single inlet centrifugal fans with sheet steel casing and impeller



**Fan:**

- Sheet steel casing.
- Forward-curved impeller made of galvanised sheet steel.
- CMP 38-2M model casing in cast aluminium.
- Maximum temperature of air to be carried: -20 °C + 120 °C, maximum +100 °C model CMP-38.

**Motor:**

- IE3 efficiency motors for powers equal to or greater than 0.75kW except single-phase, 2-speed and 8-pole.
- Class F motors with ball bearings and IP55 protection except single-phase models, with IP54 protection CMP-38 model with IP21 protection.
- Multi voltage motor, special design valid for 220/380V 60Hz, 254/440V 60Hz, 265/460V 60Hz, 277/480V 60Hz.

**Finish:**

- Anti-corrosive finish of polyester resin polymerised at 190 °C, previously degreased with phosphate-free nanotechnological treatment.

**On request:**

- Special windings for different voltages.
- Fan prepared for air transmission of up to 250 °C.
- Stainless steel fan.
- Category 2 ATEX certification (see CMP/ATEX series).

*Dynamically-balanced impellers with extremely robust cores*

### Order code

**CMP** — **1128** — **2T** — **5.5** — **60Hz**

CMP: Medium pressure, single inlet centrifugal fans with sheet steel casing and impeller

Impeller size

Number of motor poles  
 2=3500 r/min. 60 Hz  
 4=1680 r/min. 60 Hz  
 6=1080 r/min. 60 Hz

T= Three-phase  
 M=Single-phase

Motor power (hp)

### Technical characteristics

**60Hz**

Model	Speed (r/min)	Max. admissible current (A)		Installed power (kW)	Maximum flow rate (m³/h)	Sound pressure level dB(A)	Approx. weight (kg)
		220-277V	380-480V				
CMP-38-2M/E	3180	0.54		0.01	135	50	2
CMP-38-2M	3120	0.54		0.01	160	50	2
CMP-512-2T	3420	0.55	0.32	0.08	490	62	4
CMP-512-2M	3480	0.6		0.08	490	62	4
CMP-512-4T	1728	0.55	0.32	0.05	255	55	3.5
CMP-512-4M	1728	0.6		0.05	255	55	3.5
CMP-514-2T	3420	1.21	0.7	0.18	800	65	5
CMP-514-2M	3240	1.8		0.18	800	65	5
CMP-514-4T	1728	0.55	0.32	0.08	565	58	4.5
CMP-514-4M	1728	0.6		0.08	565	58	4.5
CMP-616-2T	3288	1.73	1	0.55	1380	69	8
CMP-616-2M	3312	2.95		0.55	1380	69	9.5
CMP-616-4T	1680	0.65	0.37	0.1	850	61	7.5
CMP-616-4M	1680	0.72		0.1	850	61	7.5
CMP-620-2T	3288	1.73	1	0.37	765	68	9.5
CMP-620-2M	3312	2.95		0.37	765	68	10
CMP-620-4T	1650	0.69	0.4	0.1	810	61	7.5
CMP-620-4M	1650	0.76		0.1	810	61	7.5
CMP-718-2T	3426	3	1.73	0.75	1485	70	12.5
CMP-718-2M	3300	5.2		0.75	1485	70	12.8

### Technical characteristics

Model	Speed (r/min)	Max. admissible current (A)		Installed power (kW)	Maximum flow rate (m <sup>3</sup> /h)	Sound pressure level dB(A)	Approx. weight (kg)
		220-277V	380-480V				
CMP-718-4T	1692	1.32	0.76	0.25	1280	63	9.5
CMP-718-4M	1692	1.4		0.25	1280	63	9.5
CMP-820-2T	3414	4.16	2.4	1.1	1950	73	15
CMP-820-2M	3420	7.1		1.1	1950	73	16
CMP-820-4T	1620	1.32	0.76	0.25	1670	66	10
CMP-820-4M	1680	2		0.25	1670	66	10
CMP-922-2T-1.5	3414	4.16	2.4	1.1	1650	70	20
CMP-922-2T-2	3432	5.63	3.25	1.5	2010	71	23
CMP-922-2T-3	3456	7.97	4.6	2.2	2600	74	25.5
CMP-922-4T	1674	2.51	1.45	0.55	2450	66	19
CMP-1025-2T-3	3456	7.97	4.6	2.2	2100	73	28.5
CMP-1025-2T-4	3474	10.57	6.1	3	2830	77	37.6
CMP-1025-4T	1692	4.59	2.65	1.1	3400	70	38.5
CMP-1128-2T-4	3474	10.57	6.1	3	2220	77	41.5
CMP-1128-2T-5.5	3480	13.34	7.7	4	3210	81	47
CMP-1128-4T	1704	8.49	4.9	2.2	5000	74	39
CMP-1128-6T	1092	3.91	2.26	0.75	3300	60	28.5
CMP-1231-4T-3	1704	8.49	4.9	2.2	4740	73	47
CMP-1231-4T-4	1704	11.09	6.4	3	5910	75	49
CMP-1231-4T-5.5	1728	14.38	8.3	4	6850	77	56
CMP-1231-6T	1128	7.48	4.3	1.5	5115	64	49
CMP-1435-4T-4	1704	11.09	6.4	3	5560	76	53
CMP-1435-4T-5.5	1728	14.38	8.3	4	6260	78	61.5
CMP-1435-4T-7.5	1746		11.4	5.5	7210	80	75.5
CMP-1435-6T	1116	9.32	5.36	2.2	6400	66	58.5
CMP-1640-4T-5.5	1728	14.38	8.3	4	7500	77	78.5
CMP-1640-4T-7.5	1746		11.4	5.5	8035	80	92.5
CMP-1640-4T-10	1746		15.1	7.5	9710	82	103.5
CMP-1640-6T	1116	9.32	5.36	2.2	8100	71	75.5
CMP-1845-4T-7.5	1746		11.4	5.5	8965	82	93.5
CMP-1845-4T-10	1746		15.1	7.5	10350	85	104.5
CMP-1845-6T	1116	9.32	5.36	2.2	8330	77	84
CMP-2050-4T-10	1746		15.1	7.5	9000	83	134
CMP-2050-4T-12.5	1740		17.8	9.2	10730	85	137
CMP-2050-4T-15	1752		21.5	11	12525	87	153
CMP-2050-4T-20	1746		28.5	15	19000	89	172
CMP-2050-6T	1128	15.6	8.95	4	11000	79	146
CMP-2563-6T	1164		31	15	21000	86	251

### Acoustic characteristics

Sound power spectrum Lw(A) in dB(A) per Hz frequency band

Model	63	125	250	500	1000	2000	4000	8000	Modelo	63	125	250	500	1000	2000	4000	8000
38	25	35	46	53	57	54	52	45	1128-6	35	45	56	63	67	64	62	55
512-2	37	47	58	65	69	66	64	57	1231-4-3	51	60	71	78	82	80	78	71
512-4	30	40	51	58	62	59	57	50	1231-4-4	53	62	73	80	84	82	80	73
514-2	40	50	61	68	72	69	67	60	1231-4-5.5	55	64	75	82	86	84	82	75
514-4	33	43	54	61	65	62	60	53	1231-6	42	51	62	69	73	71	69	62
616-2	44	54	65	72	76	73	71	64	1435-4-4	54	63	74	81	85	83	81	74
616-4	36	46	57	64	68	65	63	56	1435-4-5.5	56	65	76	83	87	85	83	76
620-2	43	53	64	71	75	72	70	63	1435-4-7.5	58	67	78	85	89	87	85	78
620-4	36	46	57	64	68	65	63	56	1435-6	44	53	64	71	75	73	71	64
718-2	45	55	66	73	77	74	72	65	1640-4-5.5	55	64	75	82	86	84	82	75
718-4	38	48	59	66	70	67	65	58	1640-4-7.5	58	67	78	85	89	87	85	78
820-2	48	58	69	76	80	77	75	68	1640-4-10	60	69	80	87	91	89	87	80
820-4	41	51	62	69	73	70	68	61	1640-6	49	58	69	76	80	78	76	69
922-2-1.5	45	55	66	73	77	74	72	65	1845-4-7.5	61	71	82	89	93	91	89	81
922-2-2	46	56	67	74	78	75	73	66	1845-4-10	64	74	85	92	96	94	92	84
922-2-3	49	59	70	77	81	78	76	69	1845-6	56	66	77	84	88	86	84	76
922-4	41	51	62	69	73	70	68	61	2050-4-10	62	72	83	90	94	92	90	82
1025-2-3	48	58	69	76	80	77	75	68	2050-4-12.5	64	74	85	92	96	94	92	84
1025-2-4	52	62	73	80	84	81	79	72	2050-4-15	66	76	87	94	98	96	94	86
1025-4	45	55	66	73	77	74	72	65	2050-4-20	68	78	89	96	100	98	96	88
1128-2-4	52	62	73	80	84	81	79	72	2050-6	58	68	79	86	90	88	86	78
1128-2-5.5	56	66	77	84	88	85	83	76	2563-6	67	77	88	95	99	96	94	87
1128-4	49	59	70	77	81	78	76	69									



Dimensions mm

CMP-38

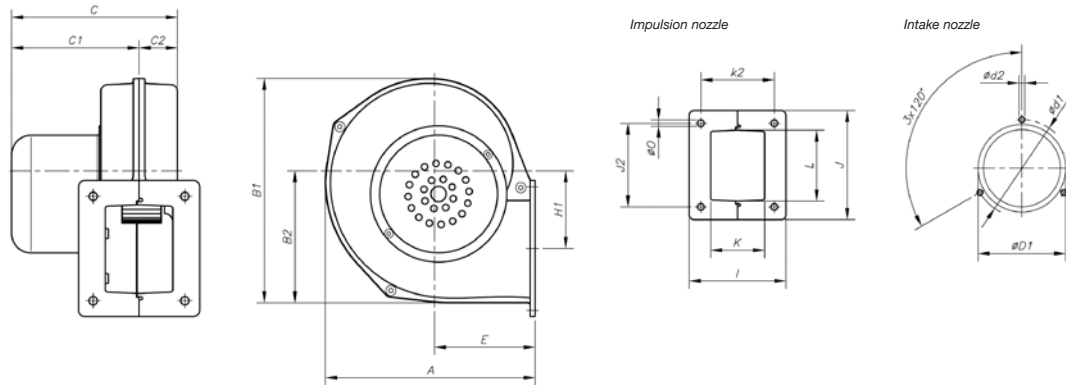

Model	A	B1	B2	C	C1	C2	øD1*	ød	ød1	ød2	E	H1	I	J	J2	K	k2	L	ø0
CMP-38-2M/E	141	165	97	122	96	26	80	85	2.4	60	60.5	100	80	46	50	77	52	8	
CMP-38-2M	164.5	176.5	103.5	130	99	31	80	85	M4	79	64	95	107	82	53	72	67	6.5	

\* Recommended nominal tube diameter

CMP-512...820

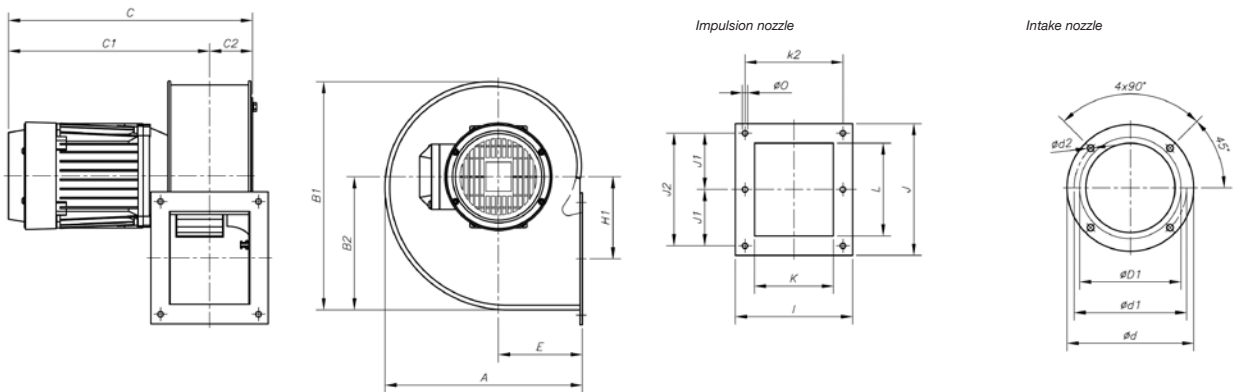

Model	A	B1	B2	C	C1	C2	øD1*	ød	ød1	ød2	E	H1	I	J	J1	J2	K	k2	L	ø0
CMP-512-2T	185	206.5	118	251	212	39	112	140	132	M4	82.5	69	104	117	-	104.5	75	92	86	5.5
CMP-512-4T	185	206.5	118	249	210	39	112	140	132	M4	82.5	69	104	117	-	104.5	75	92	86	5.5
CMP-514-2T	225	254	150	281	236	45	140	169	151.5	M4	100	91	122	147	64	128	838	105	107	6.5
CMP-514-4T	225	254	150	261	216	45	140	169	151.5	M4	100	91	122	147	64	128	83	105	107	6.5
CMP-616-2T	258	297	173.5	320	264	56	160	204	180	M6	110	105.5	153	172	-	147	103	128	125	7
CMP-616-4T	258	297	173.5	283	227	56	160	204	180	M6	110	105.5	153	172	-	147	103	128	125	7
CMP-620-2T	298	347	202.5	321	265	56	200	247	230	M6	126	145.5	159	153	-	128	105	134	100	8
CMP-620-4T	298	347	202.5	283	227	56	200	247	230	M6	126	145.5	159	153	-	128	105	134	100	8
CMP-718-2T	303.5	348	201	355	294	61	180	238	210	M6	129.5	122	169	192	85	170	115	145	146	9
CMP-718-2M	303.5	348	201	355	245	61	180	238	210	M6	129.5	122	169	192	85	170	115	145	146	9
CMP-718-4T	303.5	348	201	331	270	61	180	238	210	M6	129.5	122	169	192	85	170	115	145	146	9
CMP-820-2T	322	377	223	369.5	301	68.5	200	247	230	M6	137.5	137	184	213	94.5	189	160	160	156	9
CMP-820-2M	322	377	223	369.5	301	68.5	200	247	230	M6	137.5	137	184	213	94.5	189	160	160	156	9
CMP-820-4T	322	377	223	345.5	277	68.5	200	247	230	M6	137.5	137	184	213	94.5	189	160	160	156	9
CMP-820-4M	322	377	223	345.5	277	68.5	200	247	230	M6	137.5	137	184	213	94.5	189	160	160	156	9

\* Recommended nominal tube diameter

Dimensions mm

CMP-922...1231

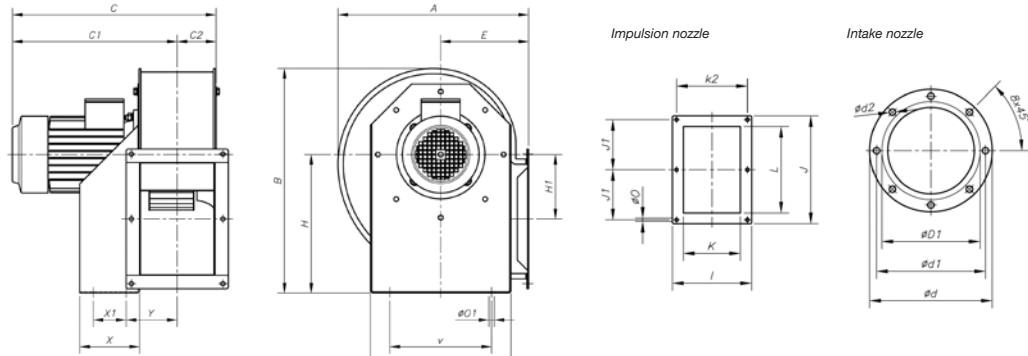

Model	A	B	C	C1	C2	øD1*	ød	ød1	ød2	E	H	H1	I	J	J1	K	k2	L	ø0	ø01	V	v	X	X1	Y
CMP-922-2T-1.5	388.5	455	382.5	309	73.5	224	278	256	M8	180	280	134	204	282.5	128	140	180	215	9.5	10.5	290	220	114	50	105
CMP-922-2T-2	388.5	455	430.5	357	73.5	224	278	25	M8	180	280	134	204	282.5	128	140	180	215	9.5	10.5	290	220	114	50	105
CMP-922-2T-3	388.5	455	430.5	357	73.5	224	278	256	M8	180	280	134	204	282.5	128	140	180	215	9.5	10.5	290	220	114	50	105
CMP-922-4T	388.5	455	382.5	309	73.5	224	278	256	M8	180	280	134	204	282.5	128	140	180	215	9.5	10.5	290	220	114	50	105
CMP-1025-2T-3	427	503	456	370	86	250	305	282	M8	197	310	144	229	312.5	145	165	205	250	9.5	12.5	315	228	134	74	115.5
CMP-1025-2T-4	427	503	486	400	86	250	305	282	M8	197	310	144	229	312.5	145	165	205	250	9.5	12.5	315	228	134	74	115.5
CMP-1025-4T	427	503	456	370	86	250	305	282	M8	197	310	144	229	312.5	145	165	205	250	9.5	12.5	315	228	134	74	115.5
CMP-1128-2T-4	472	553	500.5	407	93.5	280	348	320	M8	216	340	152	244	364	170	180	220	296.5	9.5	12.5	348	245	144	95	122.5
CMP-1128-2T-5.5	472	553	523.5	430	93.5	280	348	320	M8	216	340	152	244	364	170	180	220	296.5	9.5	12.5	348	245	144	95	122.5
CMP-1128-4T	472	553	500.5	407	93.5	280	348	320	M8	216	340	152	244	364	170	180	220	296.5	9.5	12.5	348	245	144	95	122.5
CMP-1128-6T	472	553	470.5	377	93.5	280	348	320	M8	216	340	152	244	364	170	180	220	296.5	9.5	12.5	348	245	144	95	122.5
CMP-1231-4T-3	526	630	520.5	417	103.5	315	382	354	M8	238	390	179.5	264	382.5	180	200	240	320	11.5	13	382	322	183	140	126
CMP-1231-4T-4	526	630	520.5	417	103.5	315	382	354	M8	238	390	179.5	264	382.5	180	200	240	320	11.5	13	382	322	183	140	126
CMP-1231-4T-5.5	526	630	543.5	440	103.5	315	382	354	M8	238	390	179.5	264	382.5	180	200	240	320	11.5	13	382	322	183	140	126
CMP-1231-6T	526	630	520.5	417	103.5	315	382	354	M8	238	390	179.5	264	382.5	180	200	240	320	11.5	13	382	322	183	140	126

\* Recommended nominal tube diameter

CMP-1435...2563

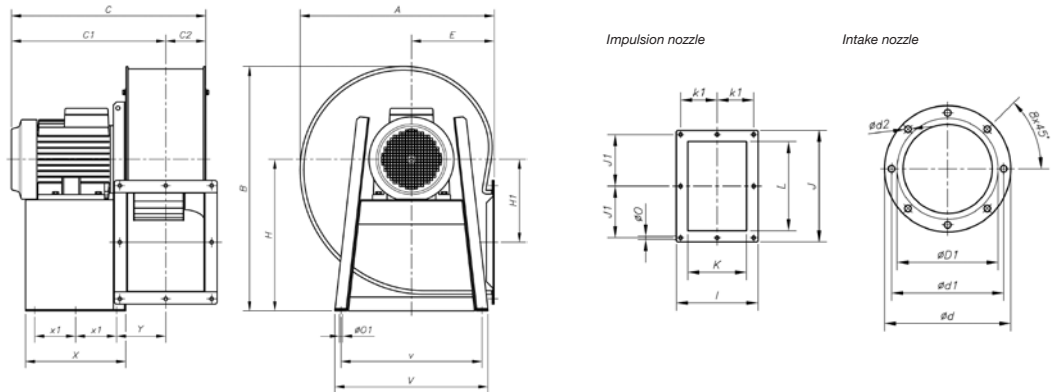

Model	A	B	C	C1	C2	øD1*	ød	ød1	ød2	E	H	H1	I	J	J1	K	k1	L	ø0	ø01	V	v	X	X1	Y
CMP-1435-4T-4	573.5	715	549	431	118	355	422	394	M8	250	445	242.5	292	342.5	159	228	133	280	11.5	12	456	420	333	136.5	150
CMP-1435-4T-5.5	573.5	715	572	454	118	355	422	394	M8	250	445	242.5	292	342.5	159	228	133	280	11.5	12	456	420	333	136.5	150
CMP-1435-4T-7.5	573.5	715	610	492	118	355	422	394	M8	250	445	242.5	292	342.5	159	228	133	280	11.5	12	456	420	333	136.5	150
CMP-1435-6T	573.5	715	572	454	118	355	422	394	M8	250	445	242.5	292	342.5	159	228	133	280	11.5	12	456	420	333	136.5	150
CMP-1640-4T-5.5	634	799	596	465	130	400	464	438	M8	270	495	271	336	404	185	250	150	321	11.5	12	500	460	327	133.5	162.5
CMP-1640-4T-7.5	634	799	634	504	130	400	464	438	M8	270	495	271	336	404	185	250	150	321	11.5	12	500	460	327	133.5	162.5
CMP-1640-4T-10	634	799	634	504	130	400	464	438	M8	270	495	271	336	404	185	250	150	321	11.5	12	500	460	327	133.5	162.5
CMP-1640-6T	634	799	596	466	130	400	464	438	M8	270	495	271	336	404	185	250	150	321	11.5	12	500	460	327	133.5	162.5
CMP-1845-4T-7.5	711	901	668	521	147	450	515	485	M8	302	560	305	370	444	202	284	164	361	11.5	12	538	502	340	140	179.5
CMP-1845-4T-10	711	901	668	521	147	450	515	485	M8	302	560	305	370	444	202	284	164	361	11.5	12	538	502	340	140	179.5
CMP-1845-6T	711	901	630	483	147	450	515	485	M8	302	560	305	370	444	202	284	164	361	11.5	12	538	502	340	140	179.5
CMP-2050-4T-10	797	987	700.5	538	162.5	500	565	535	M10	345	610	313	411	544	250	315	182.5	451	11.5	12	653	615	435	188	196
CMP-2050-4T-12.5	797	987	752.5	590	162.5	500	565	535	M10	345	610	313	411	544	250	315	182.5	451	11.5	12	653	615	435	188	196
CMP-2050-4T-15	797	987	805.5	643	162.5	500	565	535	M10	345	610	313	411	544	250	315	182.5	451	11.5	12	653	615	435	188	196
CMP-2050-4T-20	797	987	805.5	643	162.5	500	565	535	M10	345	610	313	411	544	250	315	182.5	451	11.5	12	653	615	435	188	196
CMP-2050-6T	797	987	700.5	538	162.5	500	565	535	M10	345	610	313	411	544	250	315	182.5	451	11.5	12	653	615	435	188	196
CMP-2563-6T	1027	1213	1016	805	211	630	710	675	M10	460	742	378	512	706	330	410	230	600	17	14	590	540	450	200	239

\* Recommended nominal tube diameter

**Characteristic curves**

Q= Flow rate in m<sup>3</sup>/h, m<sup>3</sup>/s and cfm.

Pe= Static pressure in mm H<sub>2</sub>O, Pa and inwg.

CMP-38...820

**2T/2M=3600 r/min**

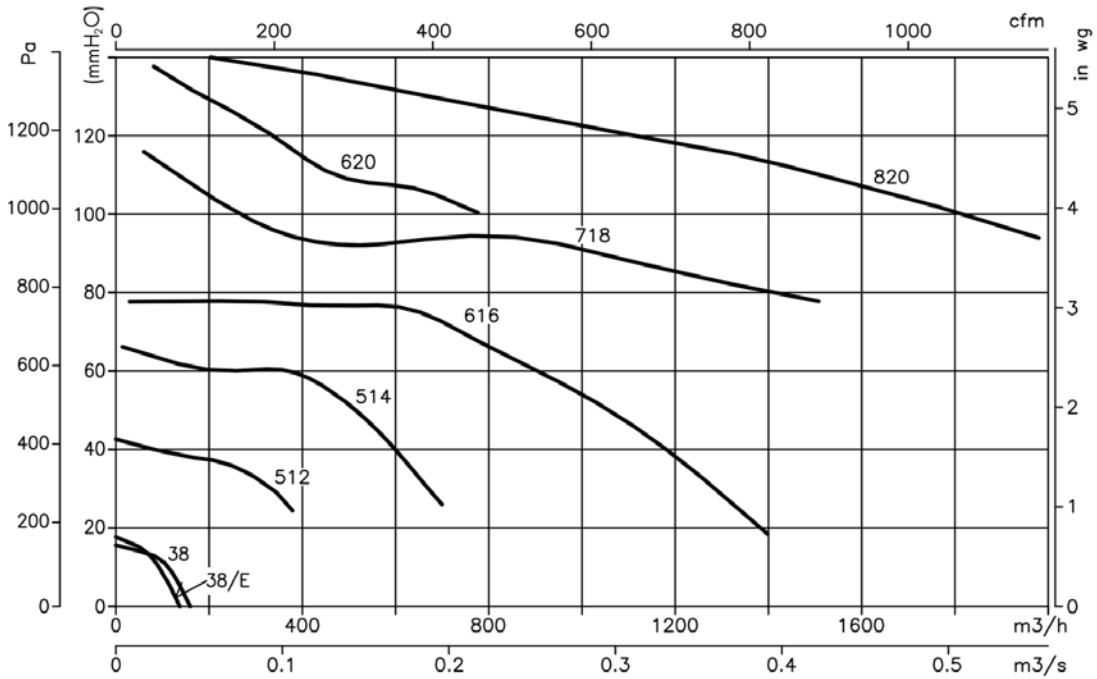

**4T/4M=1800 r/min**

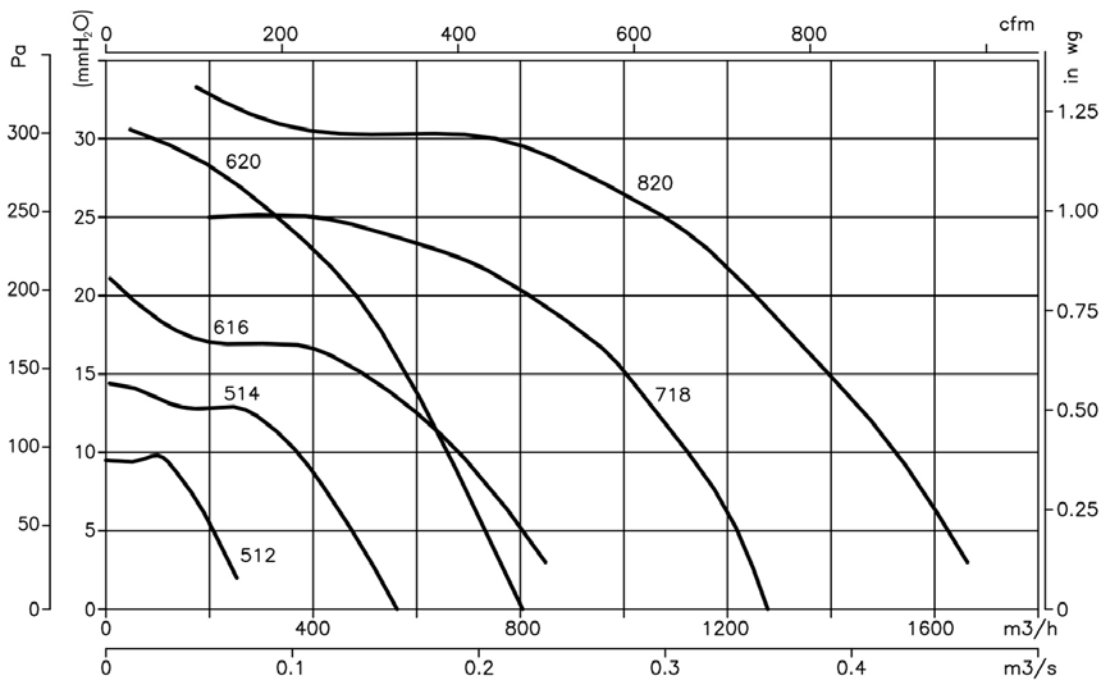

**Characteristic curves**

Q= Flow rate in m<sup>3</sup>/h, m<sup>3</sup>/s and cfm.

Pe= Static pressure in mm H<sub>2</sub>O, Pa and inwg.

CMP-922...1231

**2T=3600 r/min**

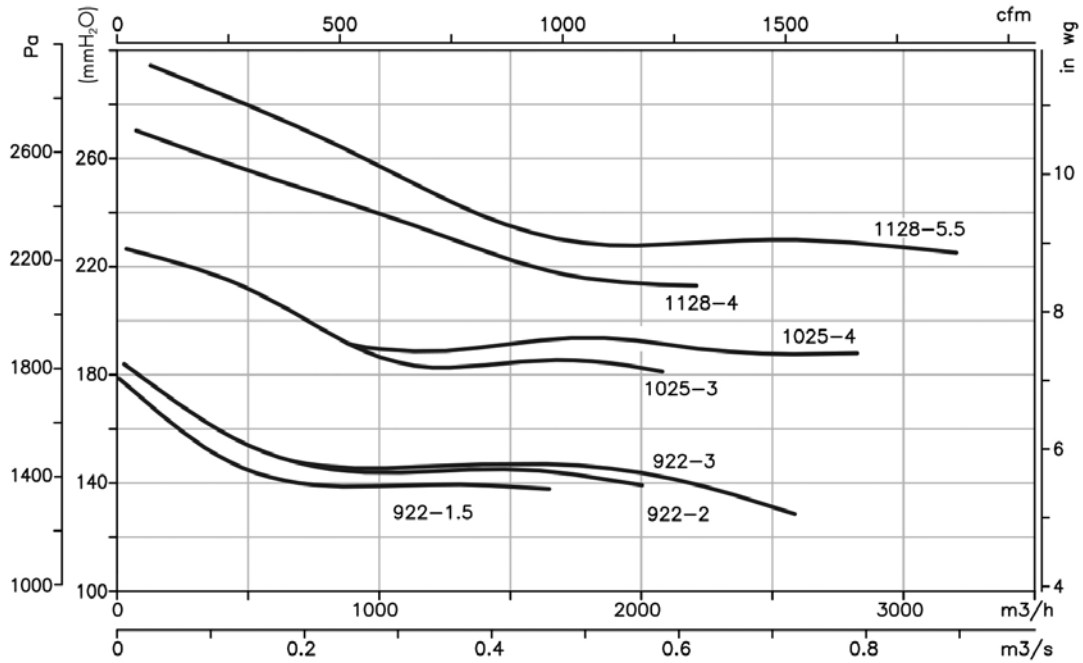

**4T=1500 r/min    6T=1200 r/min**

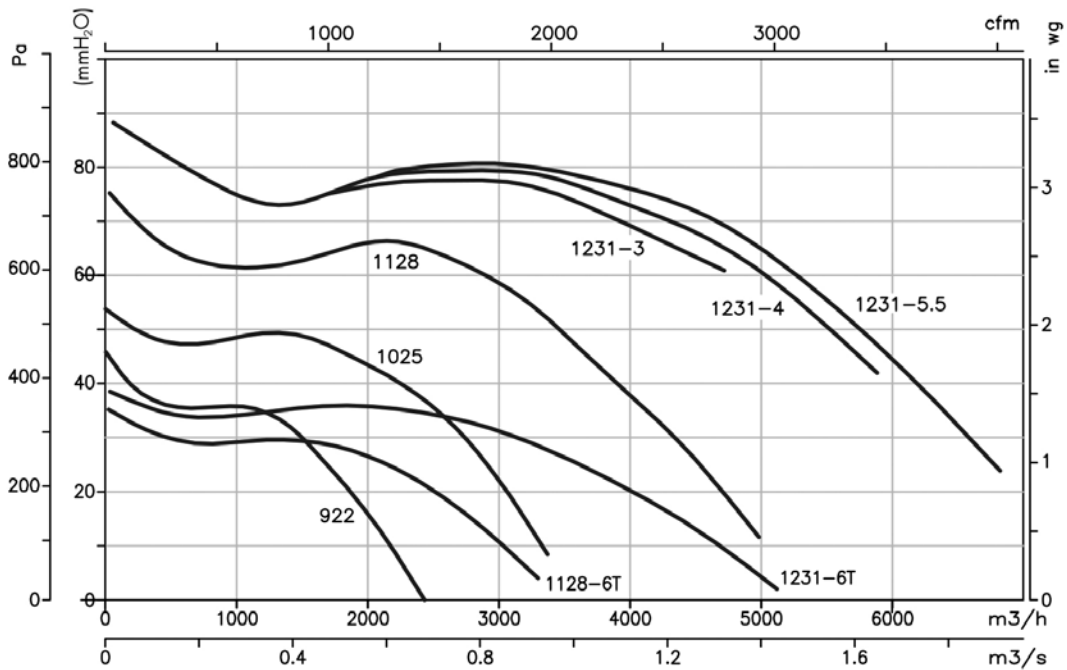

**Characteristic curves**

Q= Flow rate in m<sup>3</sup>/h, m<sup>3</sup>/s and cfm.

Pe= Static pressure in mm H<sub>2</sub>O, Pa and inwg.

CMP-1435...2563

**4T=1800 r/min**

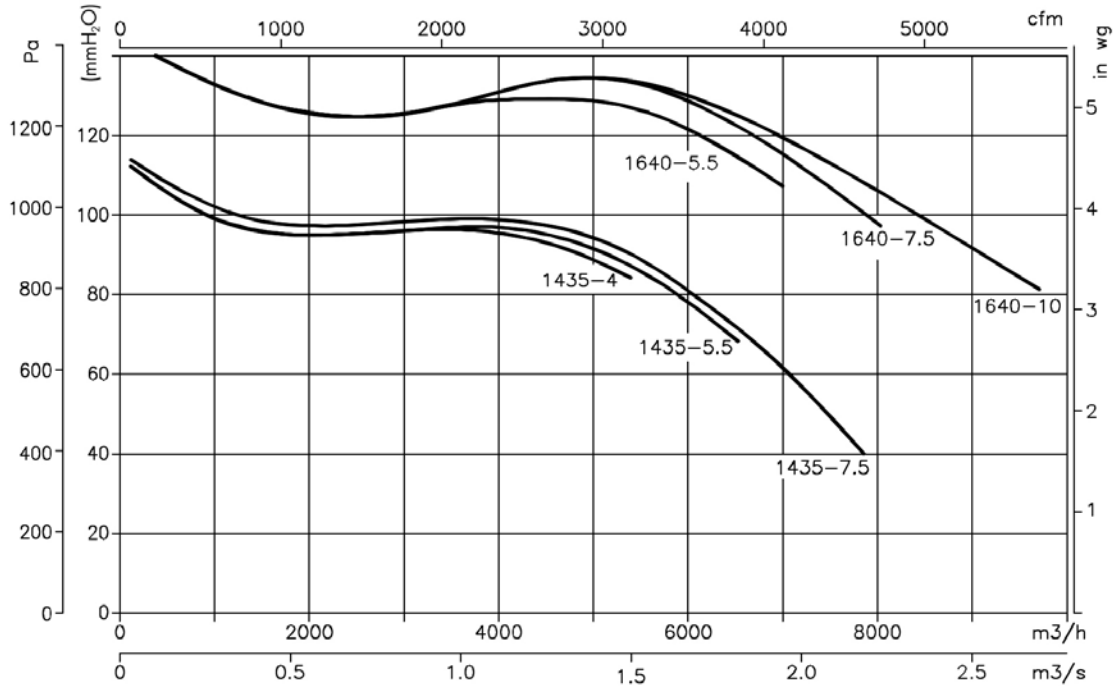

**4T=1800 r/min**

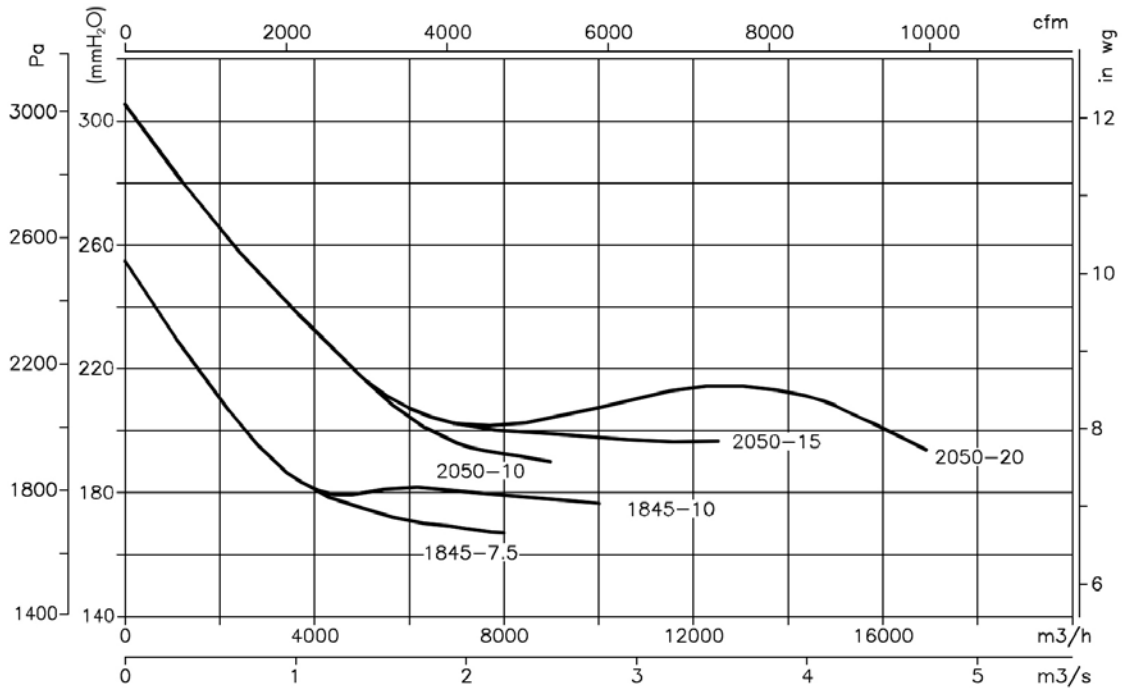

**Characteristic curves**

Q= Flow rate in m<sup>3</sup>/h, m<sup>3</sup>/s and cfm.

Pe= Static pressure in mm H<sub>2</sub>O, Pa and inwg.

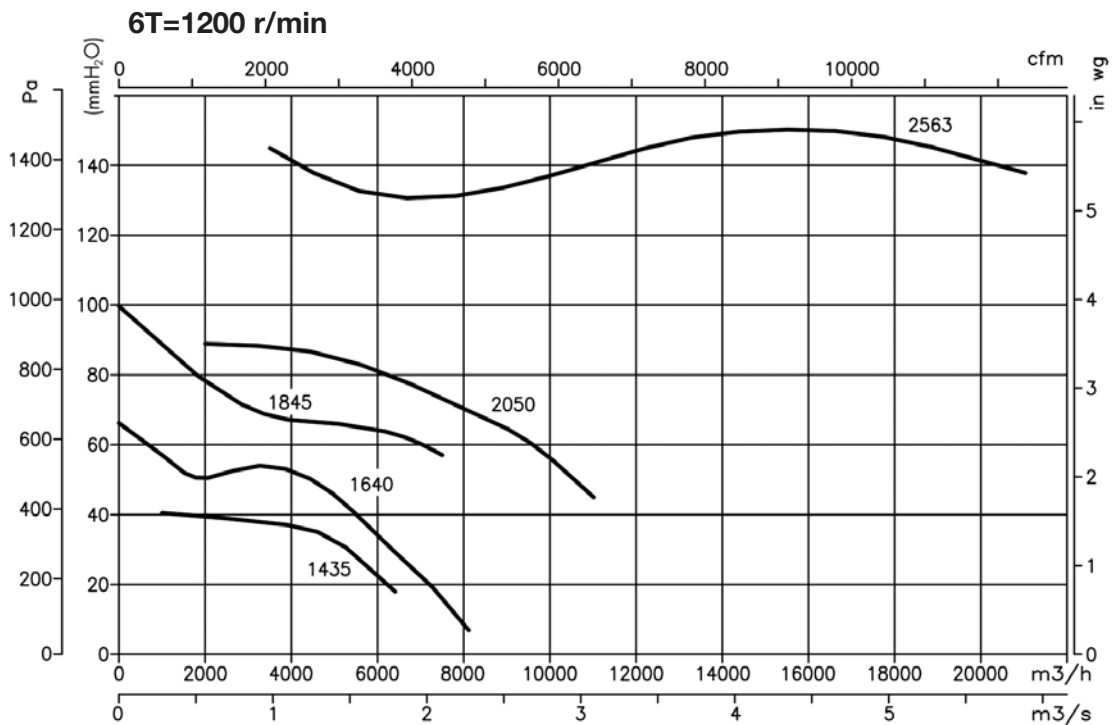

**Orientation**

Standard supply LG 270.

Positions LG 180 and RD 180 on request with special anchoring measurements.



**Accessories**

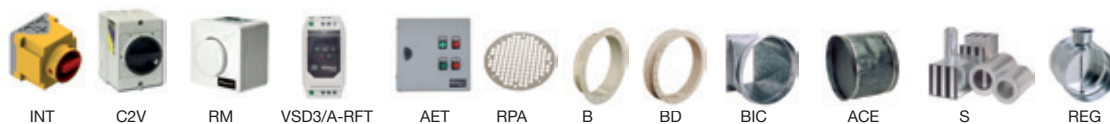

# CMR

**Extremely robust medium pressure, single inlet centrifugal fans fitted with a backward-curved impeller.**



Extremely robust, high performance reaction impeller

**Fan:**

- Sheet steel casing.
- Impeller with reaction blades in extremely robust sheet steel.

**Motor:**

- IE3 efficiency motors for powers equal to or greater than 0.75kW except single-phase, 2-speed and 8-pole.
- Class F motors with ball bearings and IP55 protection.
- Multi voltage motor, special design valid for 220/380V 60Hz, 254/440V 60Hz, 265/460V 60Hz, 277/480V 60Hz.
- Maximum temperature of air to be carried: -20 °C.+ 120 °C.

**Finish:**

- Anti-corrosive finish of polyester resin polymerised at 190 °C, previously degreased with phosphate-free nanotechnological treatment.

**On request:**

- Special windings for different voltages.
- Fan prepared for air transmission of up to 250 °C.
- Stainless steel fan.
- Category 2 ATEX certification (see CMR/ATEX series).

**Order code**

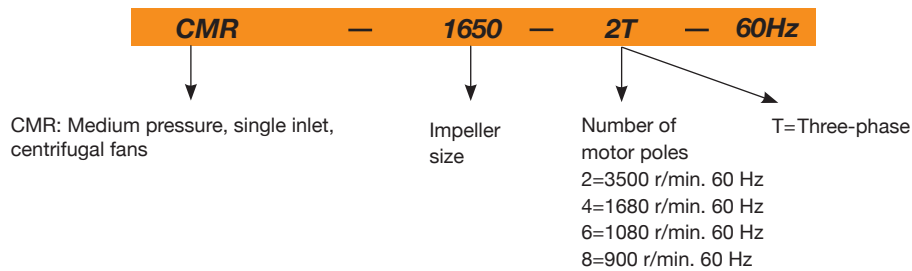

**60Hz**

**Technical characteristics**

Model	Speed (r/min)	Max. admissible current (A)		Installed power (kW)	Maximum flow rate (m³/h)	Sound pressure level dB(A)	Approx. weight (kg)
		220-277V	380-480V				
CMR-1031-2T-3	3480	7.88	4.55	2.20	5950	80	44.3
CMR-1135-2T-5.5	3480	13.51	7.80	4.00	7700	83	54.9
CMR-1240-2T	3475	13.51	7.80	4.00	7650	86	93.5
CMR-1240-4T	1745	3.22	1.86	0.75	5850	71	70.5
CMR-1445-2T	3500		13.90	7.50	10800	87	126.0
CMR-1445-4T	1750	5.89	3.40	1.50	8950	72	92.5
CMR-1650-2T-15	3490		20.00	11.00	15950	89	178.0
CMR-1650-4T-3	1730	8.49	4.90	2.20	11700	74	114.0
CMR-1650-6T	1165	5.04	2.90	1.10	7850	64	114.0
CMR-1856-4T-5.5	1745	14.38	8.30	4.00	15350	79	152.0
CMR-1856-6T	1160	7.48	4.30	1.50	11100	70	146.5
CMR-2063-4T	1750		11.40	5.50	19000	80	226.0
CMR-2063-6T	1120	7.48	4.30	1.50	12300	71	208.5
CMR-2063-8T	870	5.90	3.39	1.10	10550	65	210.5
CMR-2271-4T	1760		21.50	11.00	30200	85	315.0
CMR-2271-6T	1140	12.20	6.82	3.00	19600	76	293.5
CMR-2271-8T	865	7.10	4.08	1.50	14300	69	275.5
CMR-2380-4T	1680		41.00	22.00	48000	83	416.0
CMR-2380-6T	1080		15.40	7.50	30000	75	363.0
CMR-2380-8T	840	12.80	7.38	3.00	22000	66	317.0
CMR-2590-4T	1770		68.00	37.00	54000	86	418.0
CMR-2590-6T	1165		23.00	11.00	34000	76	378.0
CMR-28100-4T	1770		98.00	55.00	75000	87	553.0
CMR-28100-6T	1180		36.00	18.50	48000	77	521.0

## Acoustic characteristics

The indicated values are determined by measuring the sound pressure level and sound power in dB(A) obtained in a free field at a distance equivalent to twice the size of the fan plus the impeller diameter, with a minimum of 1.5 m.

Sound power spectrum Lw(A) in dB(A) per Hz frequency band.

Model	63	125	250	500	1000	2000	4000	8000	Model	63	125	250	500	1000	2000	4000	8000
1031-2	65	78	78	91	86	86	86	79	2063-6	69	70	82	82	81	83	73	63
1135-2	72	79	77	89	87	93	92	79	2063-8	64	70	77	76	77	74	66	57
1240-2	68	83	81	93	90	94	96	83	2271-4	83	84	93	96	98	99	95	82
1240-4	56	70	76	79	79	80	70	59	2271-6	73	73	87	86	90	90	79	68
1445-2	73	85	83	95	93	97	99	89	2271-8	68	73	78	85	81	80	70	59
1445-4	59	72	78	83	80	83	78	64	2380-4	76	78	94	91	96	97	93	82
1650-2	73	81	85	99	97	99	99	88	2380-6	68	70	86	83	88	89	85	74
1650-4	64	74	82	84	83	85	76	66	2380-8	59	61	77	74	79	80	76	65
1650-6	53	65	72	77	73	69	62	54	2590-4	79	84	97	100	96	89	84	66
1856-4	69	78	91	87	90	91	85	71	2590-6	70	79	89	88	85	84	74	68
1856-6	61	69	81	83	80	81	71	60	28100-4	82	89	101	102	97	93	87	78
2063-4	80	85	91	93	91	88	81	73	28100-6	73	82	91	90	88	86	77	70

## Dimensions mm

### CMR-1031...2271

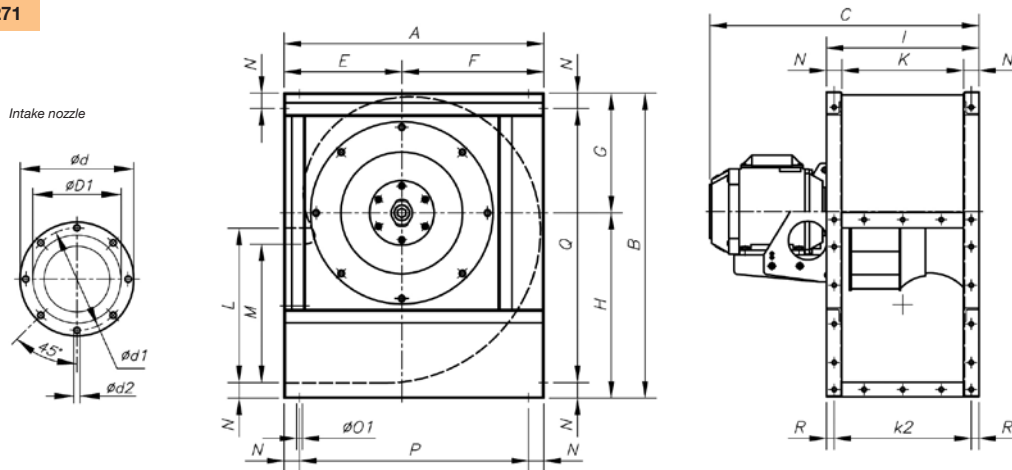

Model	A	B	C	$\phi D1^*$	$\phi d$	$\phi d1$	$\phi d2$	E	F	G	H	I	K	k2	L	M	N	$\phi O1$	P	Q	R
CMR-1031-2T	542	626	567	315	383	356	M8	250	292	245	381	320	250	285	315	276	35	11	472	556	17.5
CMR-1135-2T	600	696	583	355	425	398	M8	275	325	273	423	350	280	315	355	310	35	11	530	626	17.5
CMR-1240-2T	673	790	728	400	472	444	M10	305	368	310	480	395	315	355	400	358	40	11	593	710	20
CMR-1240-4T	673	790	590	400	472	444	M10	305	368	310	480	395	315	355	400	358	40	11	593	710	20
CMR-1445-2T	765	880	810	450	522	494	M10	350	415	339	541	445	355	405	450	404	45	11	675	790	20
CMR-1445-4T	765	880	649	450	522	494	M10	350	415	339	541	445	355	405	450	404	45	11	675	790	20
CMR-1650-2T	832	970	961	500	582	555	M10	375	457	378	592	490	400	450	500	445	45	13	742	880	20
CMR-1650-4T	832	970	715	500	582	555	M10	375	457	378	592	490	400	450	500	445	45	13	742	880	20
CMR-1650-6T	832	970	695	500	582	555	M10	375	457	378	592	490	400	450	500	445	45	13	742	880	20
CMR-1856-4T	925	1084	832	560	645	615	M10	415	510	426	658	550	450	500	560	493	50	13	825	984	25
CMR-1856-6T	925	1084	771	560	645	615	M10	415	510	426	658	550	450	500	560	493	50	13	825	984	25
CMR-2063-4T	1037	1218	973	630	720	688	M10	465	572	477	741	620	500	560	630	530	60	13	917	1098	30
CMR-2063-6T	1037	1218	893	630	720	688	M10	465	572	477	741	620	500	560	630	530	60	13	917	1098	30
CMR-2063-8T	1037	1218	893	630	720	688	M10	465	572	477	741	620	500	560	630	530	60	13	917	1098	30
CMR-2271-4T	1173	1375	1126	710	800	768	M12	525	648	538	837	690	560	625	710	603	65	13	1043	1245	32.5
CMR-2271-6T	1173	1375	1039	710	800	768	M12	525	648	538	837	690	560	625	710	603	65	13	1043	1245	32.5
CMR-2271-8T	1173	1375	1002	710	800	768	M12	525	648	538	837	690	560	625	710	603	65	13	1043	1245	32.5

\* Recommended nominal tube diameter



Dimensions mm

CMR-2380...28100

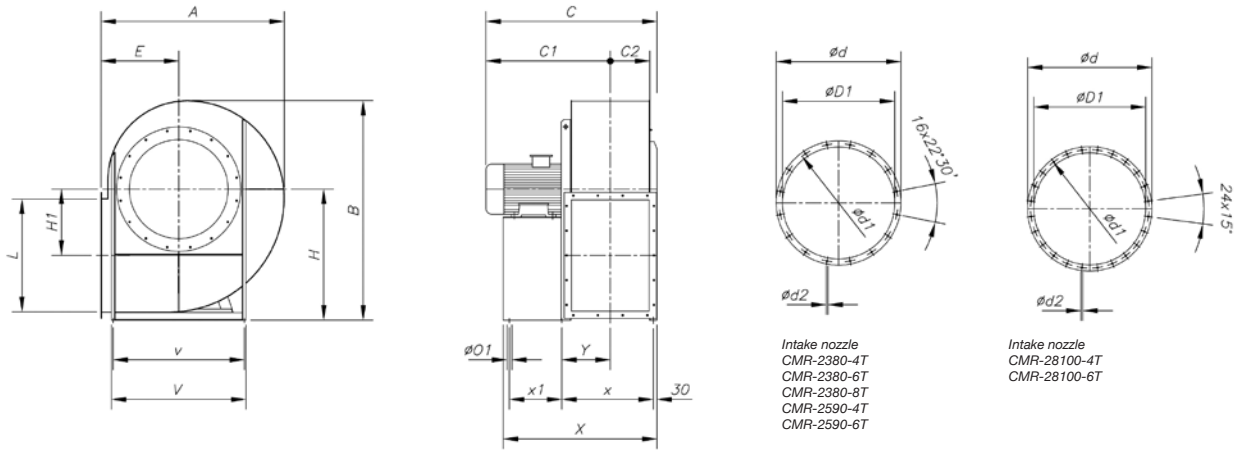

Model	A	B	C	C1	C2	$\phi D1^*$	$\phi d$	$\phi d1$	$\phi d2$	E	H	H1	L	$\phi O1$	V	v	X	x	x1	Y
CMR-2380-4T	1350	1660	1245	899	286	808	906	861	11.5	560	1000	500	800	17	930	870	1102.5	667.5	370	352.5
CMR-2380-6T	1350	1660	1030	744	286	808	906	861	11.5	56	1000	500	800	17	930	870	1102.5	667.5	370	352.5
CMR-2380-8T	1350	1660	1035	681	286	808	906	861	11.5	560	1000	500	800	17	930	870	1102.5	667.5	370	352.5
CMR-2590-4T	1495	1785	1390	1012	321	908	1008	958	14	630	1060	535	900	19	1030	970	1246	425	751	393
CMR-2590-6T	1495	1785	1235	857	321	908	1008	958	14	630	1060	535	900	19	1030	970	1121	340	721	373
CMR-28100-4T	1680	1990	1470	1051	362	1008	1108	1067	14	710	1180	610	1000	19	1130	1060	1378	460	843	454
CMR-28100-6T	1680	1990	1395	976	362	1008	1108	1067	14	710	1180	610	1000	19	1130	1060	1278	385	823	434

\* Recommended nominal tube diameter

Impulsion nozzle

CMR-1031  
CMR-1135  
CMR-2590  
CMR-28100

CMR-1240  
CMR-1445  
CMR-1650

CMR-1856

CMR-2063

CMR-2271

CMR-2380

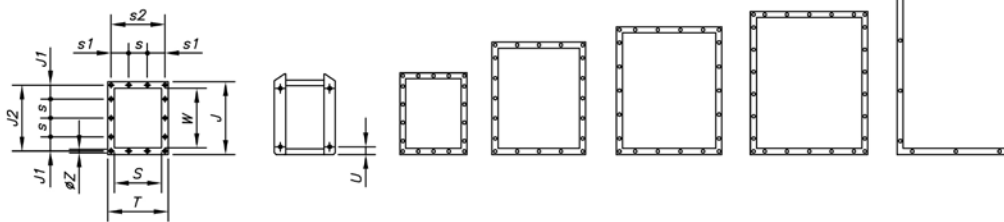

Model	T	J	J1	J2	S	s	s1	s2	W	$\phi z$	U
CMR-1031	320	385	75	350	250	100	92.5	285	315	9	-
CMR-1135	350	425	95	390	280	100	107.5	315	355	9	-
CMR-1240	395	480	70	440	315	100	77.5	355	400	11	-
CMR-1445	445	540	99	498	355	100	102.5	403	450	11	-
CMR-1650	490	590	88	550	400	125	100	450	500	11	-
CMR-1856	550	660	55	610	450	125	125	500	560	13	-
CMR-2063	620	750	95	690	500	125	92.5	560	630	13	-
CMR-2271	690	840	75	775	560	125	62.5	625	710	13	-
CMR-2380	689	921	135.5	871	569	200	119.5	639	801	14	-
CMR-2590	758	1018	84	968	638	200	54	708	898	18	-
CMR-28100	835	1127	138.5	1077	715	200	92.5	785	1007	18	-

**Characteristic curves**

Q= Flow rate in m<sup>3</sup>/h, m<sup>3</sup>/s and cfm.

Pe= Static pressure in mm H<sub>2</sub>O, Pa and inwg.

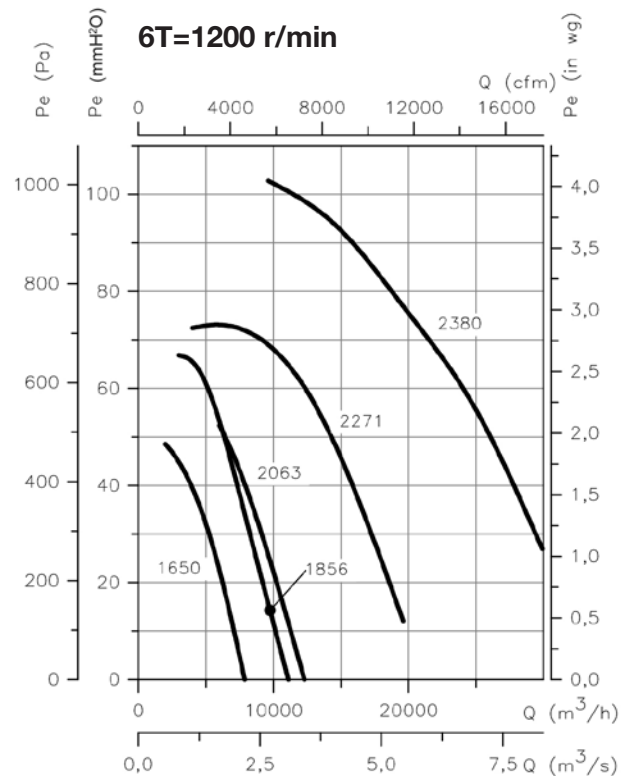
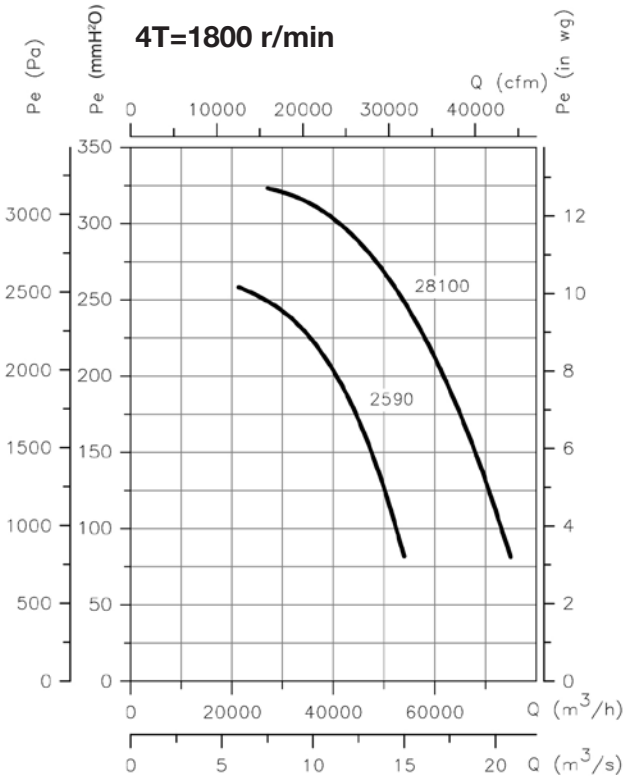
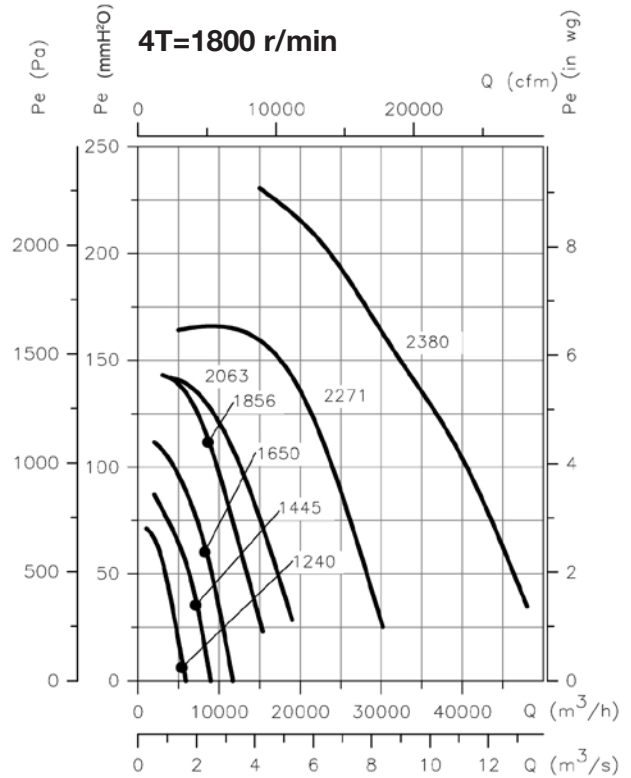
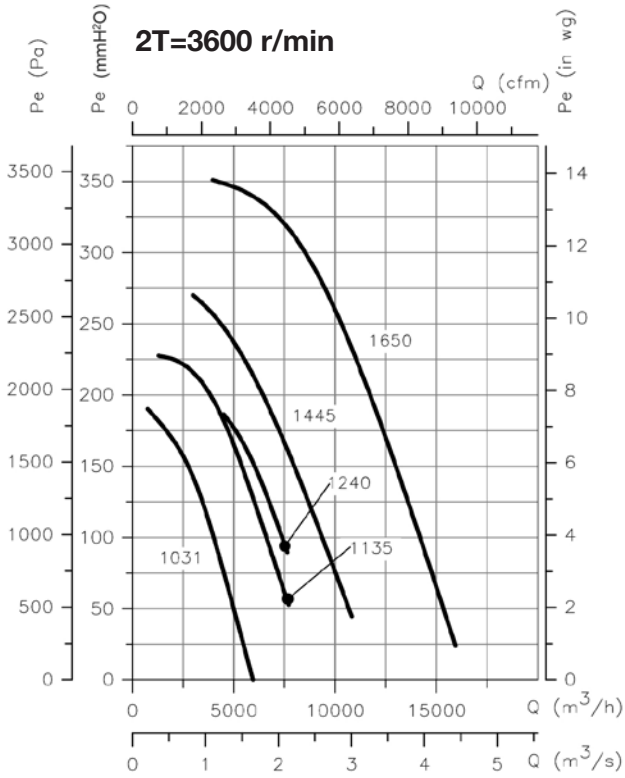

**Characteristic curves**

Q= Flow rate in m<sup>3</sup>/h, m<sup>3</sup>/s and cfm.

Pe= Static pressure in mm H<sub>2</sub>O, Pa and inwg.

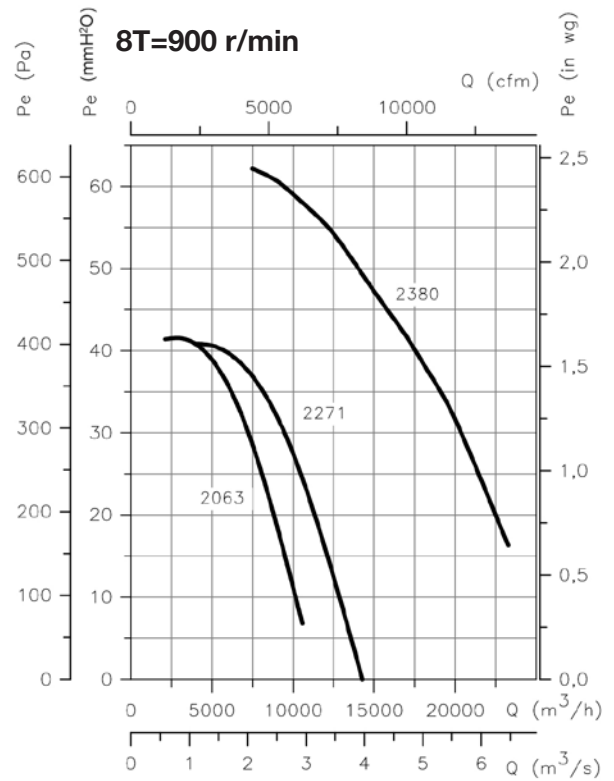
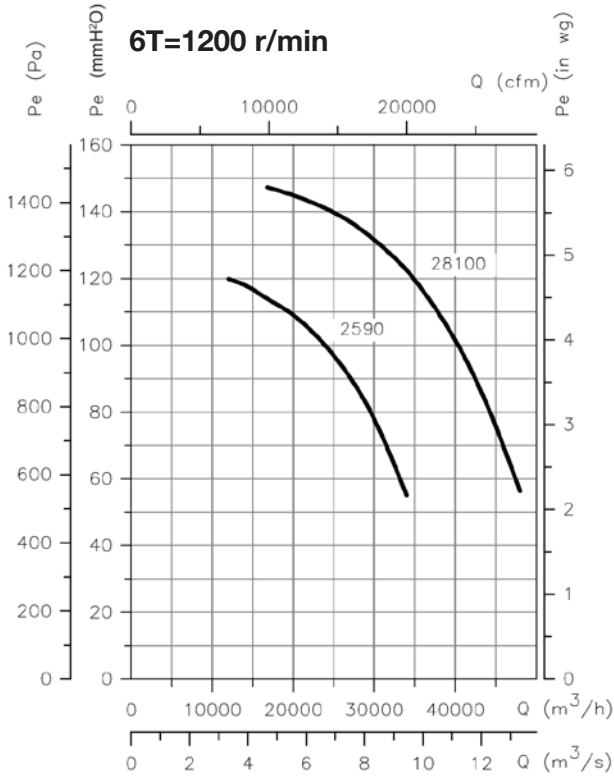

**Orientation**

Standard supply LG 270.

Models 2380, 2590 and 28100 with LG 270 fixed orientation (other orientations only on request).



**Accessories**



# CMA

## Medium pressure, single inlet centrifugal fans with cast aluminium casing and impeller

### Fan:

- Cast aluminium casing.
- Cast aluminium impeller.
- Models 324, 325 and 426 impeller in polyamide, model 531-2T-3 impeller in sheet steel.

### Motor:

- IE3 efficiency motors for powers equal to or greater than 0.75kW except single-phase, 2-speed and 8-pole.
- Class F motors with ball bearings and IP55 protection except single-phase models, with IP54 protection.
- Multi voltage motor, special design valid for 220/380V 60Hz, 254/440V 60Hz, 265/460V 60Hz, 277/480V 60Hz.
- Maximum temperature of air to be carried: -20 °C + 120 °C, maximum +70 °C models with polyamide impeller.

### Finish:

- Anti-corrosive finish of polyester resin polymerised at 190 °C, previously degreased with phosphate-free nanotechnological treatment.

### On request:

- Special windings for different voltages.
- Cast aluminium impellers for models 324, 325 and 426.
- Fan prepared for air transmission of up to 250 °C.
- Category 2 ATEX certification (see CMA/ATEX series).



Different impulsion position options

### Order code

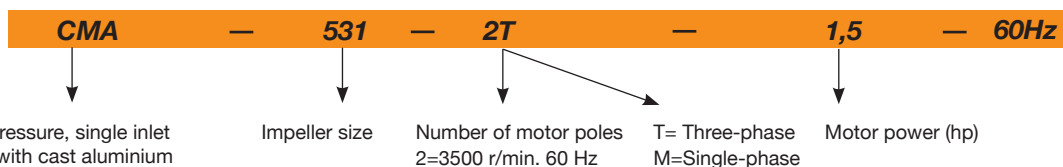

### Technical characteristics

**60Hz**

Model	Speed (r/min)	Maximum admissible current (A)		Installed power (kW)	Maximum flow rate (m <sup>3</sup> /h)	Sound pressure level dB(A)	Approx. weight (kg)
		220-277V	380-480V				
CMA-218-2T	3504	0.61	0.35	0.09	265	63	6
CMA-218-2M	3504	0.6	-	0.09	265	63	6
CMA-324-2T	3420	1.21	0.7	0.18	440	70	9
CMA-324-2M	3420	1.5	-	0.18	440	70	9
CMA-325-2T	3336	1.64	0.95	0.25	600	73	11
CMA-325-2M	3336	2.2	-	0.25	600	73	11
CMA-426-2T	3318	1.78	1.03	0.37	850	75	13
CMA-426-2M	3318	2.95	-	0.37	850	75	13
CMA-527-2T	3360	2.42	1.4	0.55	1000	80	14.8
CMA-527-2M	3360	3.9	-	0.55	1000	80	14.8
CMA-528-2T-1	3336	3.12	1.8	0.75	1250	82	23.5
CMA-528-2M-1	3336	5.2	-	0.75	1250	82	23.5
CMA-528-2T-1.5	3420	4.42	2.55	1.1	1750	83	26
CMA-528-2M-1.5	3420	7.1	-	1.1	1750	83	26
CMA-531-2T-1.5	3456	4.42	2.55	1.1	1790	84	29
CMA-531-2M-1.5	3456	7.1	-	1.1	1790	84	29
CMA-531-2T-2	3420	5.89	3.4	1.5	2000	85	31
CMA-531-2M-2	3420	9.3	-	1.5	2000	85	31
CMA-531-2T-3	3360	8.23	4.75	2.2	2400	86	30
CMA-540-2T	3468	5.89	3.4	1.5	2600	85	38
CMA-545-2T-3	3408	8.23	4.75	2.2	2630	86	54
CMA-545-2T-4	3456	10.91	6.3	3	3550	88	64

Acoustic characteristics

Sound power spectrum Lw(A) in dB(A) per Hz frequency band

Model	63	125	250	500	1000	2000	4000	8000	Modelo	63	125	250	500	1000	2000	4000	8000
218	29	43	61	67	71	68	63	54	531-1.5	50	64	82	88	92	89	84	75
324	36	50	68	74	78	75	70	61	531-2	51	65	83	89	93	90	85	76
325	39	53	71	77	81	78	73	64	531-3	52	66	84	90	94	91	86	77
426	41	55	73	79	83	80	75	66	540	54	67	85	91	96	92	87	79
527	46	60	78	84	88	85	80	71	545-3	55	68	86	92	97	93	88	80
528-1	48	62	80	86	90	87	82	73	545-4	57	70	88	94	99	95	90	82
528-1.5	49	63	81	87	91	88	83	74									

Dimensions mm

CMA-218...531

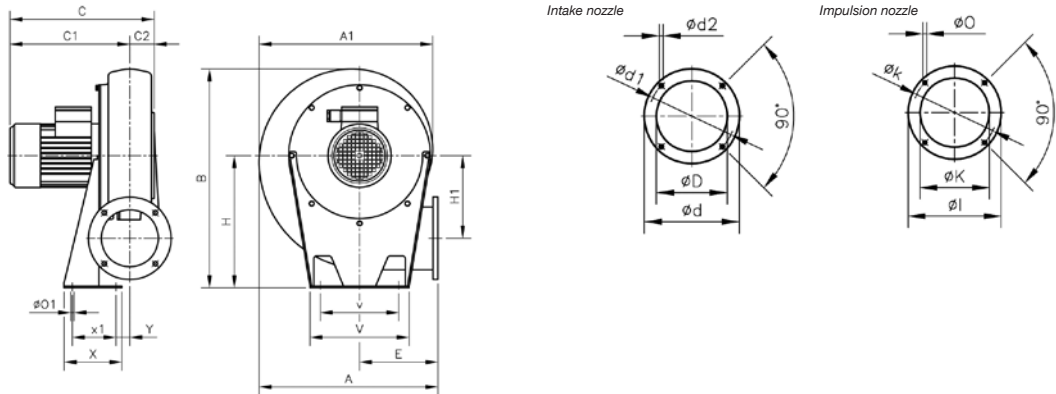

Model	A	A1	B	C	C1	C2	øD	ød	ød1	ød2	E	H	H1	øI	øK	øk	ø0	ø01	V	v	X	x1	Y
CMA-218	241	236	288	239	208	32	80	113	90	M5	110	170	114.5	90	54	76	5.5	7	140	100	80	50	20
CMA-324	311	302	356	268	202	38	80	130	112	M5	145	205	145	108	62	90	7	9	173	125	90	60	20
CMA-325	335	328	399	271	223	40	94	140	122	M6	155	235	152	120	80	102	7	9	180	145	110	80	20
CMA-426	354	344	412	291	250	40	117	155	132	M6	162	240	163	140	90	119	7	13	210	160	105	65	26
CMA-527	371	361	440	295	254	42	125	170	147	M6	168	260	170	155	100	129	7	13	220	170	120	80	20
CMA-528...1	401	395	488	340	289	51	116	190	162	M6	178	290	177	190	130	160	11	13	230	180	140	100	20
CMA-528...1.5	401	395	488	337	289	48	135	190	162	M6	178	290	177	190	130	160	11	13	230	180	140	100	20
CMA-531...1.5	440	434	537	341	290	50	160	215	180	M6	193	320	200	200	140	175	11	13	240	190	160	120	21
CMA-531...2	440	434	537	388	340	50	160	215	180	M6	193	320	200	200	140	175	11	13	240	190	160	120	21
CMA-531...3	440	434	537	388	350	50	160	215	180	M6	193	320	200	200	140	175	11	13	240	190	160	120	21

CMA-540-545

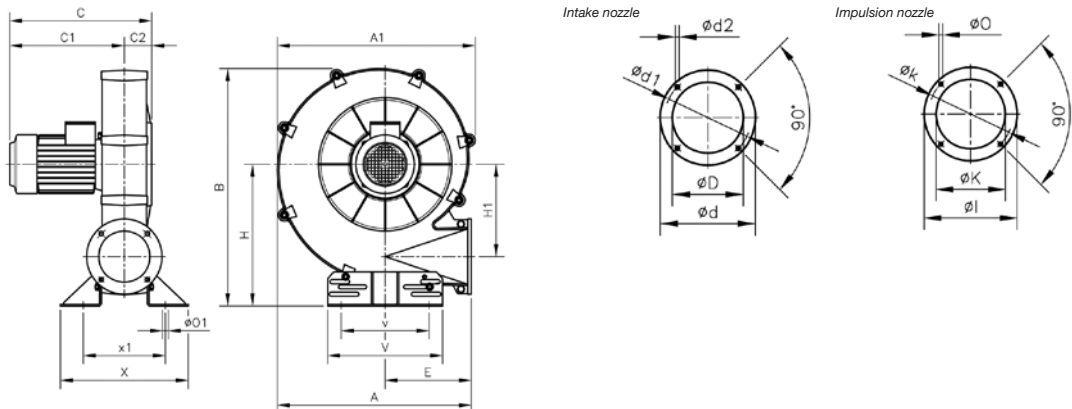

Model	A	A1	B	C	C1	C2	øD	ød	ød1	ød2	E	H	H1	øI	øK	øk	ø0	ø01	V	v	X	x1	Y
CMA-540	567	580	695	375	320	80	170	240	205	M10	252	415	270	220	150	190	13	11	336	218	374	240	-
CMA-545...3	651	646	776	423	344	115	180	255	220	M10	290	450	309	250	175	220	13	13	336	238	392	292	-
CMA-545...4	651	646	776	497	344	115	180	255	220	M10	290	450	309	250	175	220	13	13	336	238	392	292	-

**Characteristic curves**

Q= Flow rate in m<sup>3</sup>/h, m<sup>3</sup>/s and cfm.

Pe= Static pressure in mm H<sub>2</sub>O, Pa and inwg.

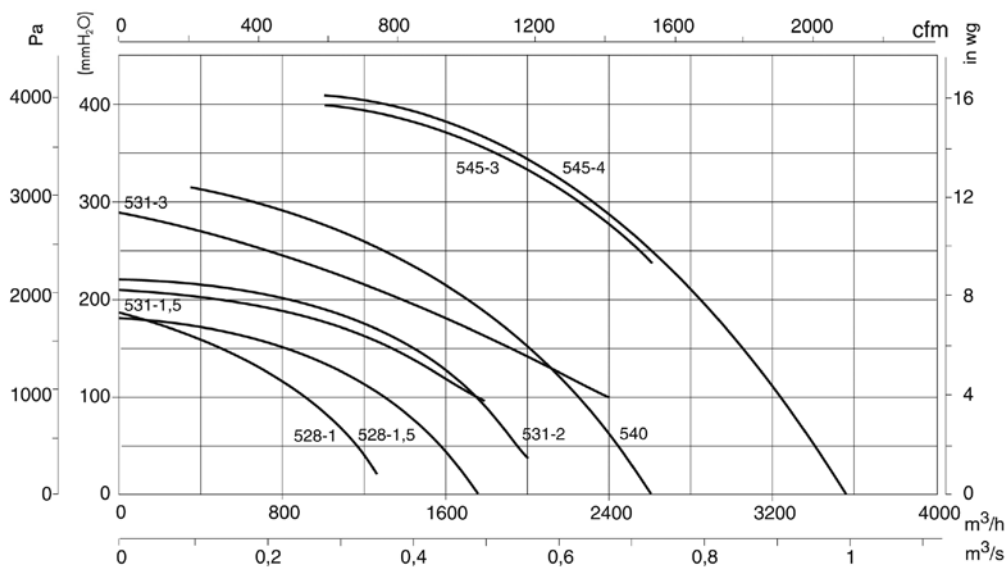
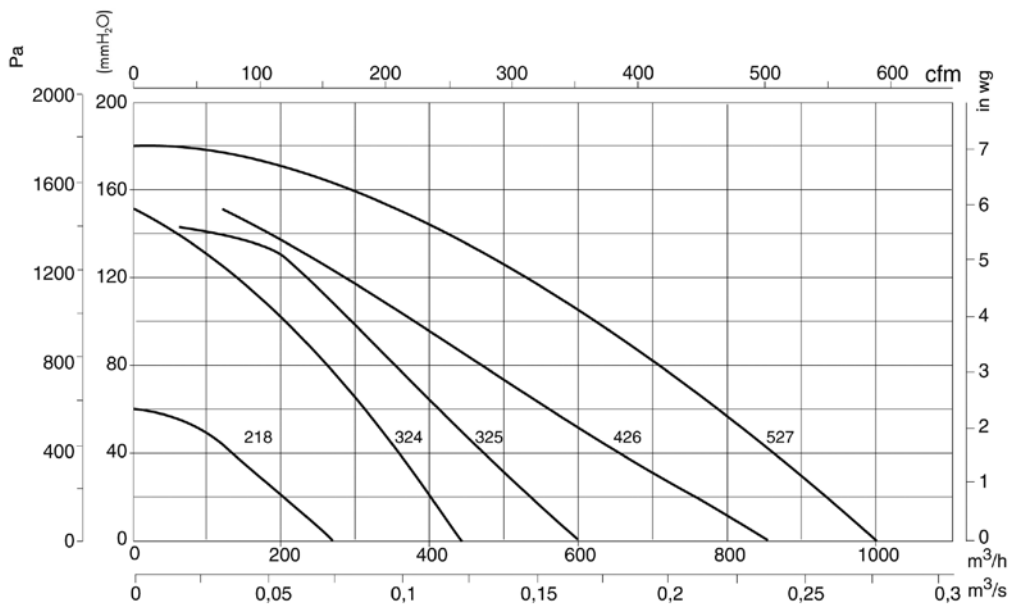

**Orientation**

Standard supply LG 270.

LG 180 position on request and with special anchoring measurements.



**Accessories**

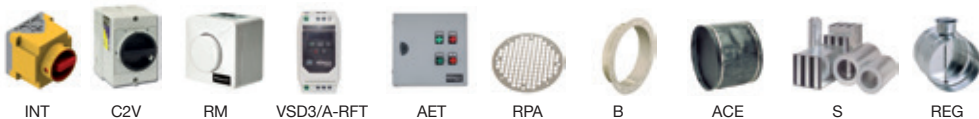

# CPV

**Anti-corrosive finished, single inlet centrifugal fans made of polypropylene**



Modern appearance and design

- Fan:
- Polypropylene casing.
  - Forward-curved impeller made of polypropylene.

- Motor:
- IE3 efficiency motors for powers equal to or greater than 0.75kW except single-phase, 2-speed and 8-pole.
  - Class F motors with ball bearings and IP55 protection.
  - Multi voltage motor, special design valid for 220/380V 60Hz, 254/440V 60Hz, 265/460V 60Hz, 277/480V 60Hz.
  - Maximum temperature of air to be carried: -20 °C +50 °C.

- Finish:
- Anti-corrosive finished in plastic material.

- On request:
- Special windings for different voltages.
  - ATEX-certified Category 3.

## Order code

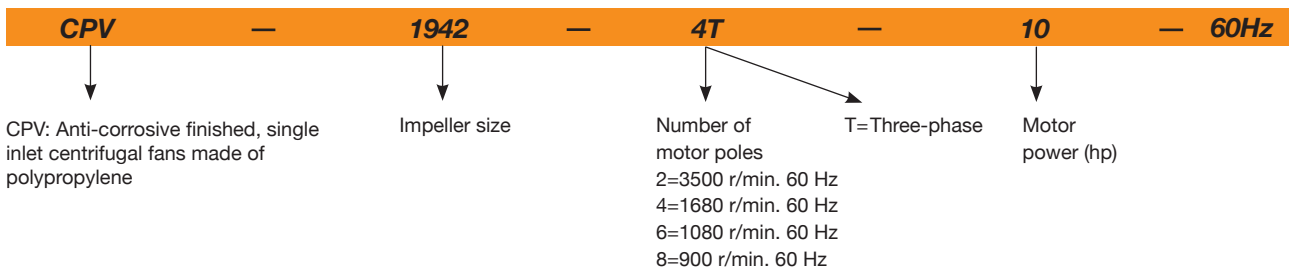

**60Hz**

## Technical characteristics

Model	Speed (r/min)	Max. admissible current (A)		Installed power (kW)	Maximum flow rate (m <sup>3</sup> /h)	Sound pres- sure level dB(A)	Approx. weight (kg)
		220-277V	380-480V				
CPV-815-2T	3372	1.73	1	0.37	950	75	14
CPV-815-4T	1632	1.32	0.76	0.25	450	58	14
CPV-1020-2T	3360	3	1.73	0.75	2000	81	19.5
CPV-1020-4T	1632	1.32	0.76	0.25	1250	65	19.5
CPV-1020-6T	1056	1.67	0.96	0.25	750	53	19.5
CPV-1325-2T	3420	7.97	4.6	2.2	3250	87	27
CPV-1325-4T	1632	1.78	1.03	0.37	2300	69	27
CPV-1325-6T	1056	1.67	0.96	0.25	1400	59	27
CPV-1630-4T	1704	5.98	3.45	1.5	4500	75	34.5
CPV-1630-6T	1092	2.8	1.61	0.55	2700	63	34.5
CPV-1840-4T	1704	11.09	6.4	3	6000	70	48
CPV-1840-6T	1080	5.04	2.9	1.1	4200	65	42
*CPV-1942-4T-7.5	1740		11.4	5.5	8500	79	66
*CPV-1942-4T-10	1740		15.1	7.5	10500	84	77
*CPV-1942-6T	1116	9.32	5.36	2.2	7000	75	49
*CPV-1942-8T	852	7.1	4.08	1.5	5500	70	56
CPV-2045-4T	1740		15.1	7.5	10400	78	102
CPV-2045-6T	1140	12.2	7	3	7000	72	88
CPV-1335-2T	3498		14.7	5.5	4700	84	91
CPV-1160-4T	1752		21.5	11	8000	83	243
CPV-2060-4T	1752		21.5	11	12000	81	245
CPV-2160-4T	1746		28.5	15	15500	77	282
*CPV-720-2T	3408	1.82	1.05	0.37	525	75	10
*CPV-825-2T	3420	4.33	2.5	1.1	1140	79	17
*CPV-930-2T	3456	7.57	4.37	2.2	1750	84	24

\*Only LG admit position

Acoustic characteristics

Sound power spectrum Lw(A) in dB(A) per Hz frequency band

Model	63	125	250	500	1000	2000	4000	8000	Modelo	63	125	250	500	1000	2000	4000	8000
815-2	56	69	77	81	81	77	73	65	1942-4-10	80	90	92	95	94	94	92	83
815-4	39	52	60	64	64	60	56	48	1942-6	71	81	83	86	85	85	83	74
1020-2	62	75	83	87	87	83	79	71	1942-8	66	76	78	81	80	80	78	69
1020-4	46	59	67	71	71	67	63	55	2045-4	63	76	84	88	89	85	81	72
1020-6	34	47	55	59	59	55	51	43	2045-6	57	70	78	82	83	79	75	66
1325-2	70	83	91	95	96	92	88	79	1335	67	80	88	92	93	89	85	76
1325-4	52	65	73	77	78	74	70	61	1160	68	81	89	93	94	90	86	77
1325-6	42	55	63	67	68	64	60	51	2060	66	79	87	91	92	88	84	75
1630-4	60	73	81	85	86	82	78	69	2160	64	77	85	89	89	85	81	73
1630-6	48	61	69	73	74	70	66	57	720	56	69	77	81	81	77	73	65
1840-4	55	68	76	80	81	77	73	64	825	60	73	81	85	85	81	77	69
1840-6	50	63	71	75	76	72	68	59	930	65	78	86	90	90	86	82	74
1942-4-7.5	75	85	87	90	89	89	87	78									

Dimensions mm

CPV-720...1942

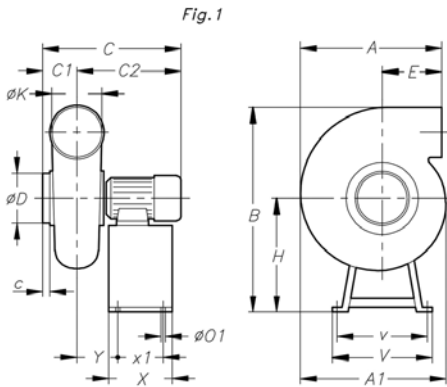

Model	Fig.	A	A1	B	C	C1	C2	c	øD	E	H	H1	øK	øO1	V	v	X	x1	Y
CPV-720	1	375	-	486	350	80	270	45	90	212	311	130	90	6	340	320	180	160	92
CPV-815	1	307	335	521	360	100	260	30	125	100	281	177.5	125	8	355	335	180	160	90
CPV-825	1	445	-	552	433	110	323	55	125	218	320	170	125	6	340	320	180	160	103
CPV-930	1	540	-	678	477	100	377	40	160	262	390	205	160	6	420	400	240	160	137
CPV-1020-2T	1	340	397	593	445.5	116	329.5	32	160	100	290	223	160	8	355	335	180	160	127.5
CPV-1020-4/6T	1	340	397	584	422.5	116	306.5	32	160	100	281	223	160	8	355	335	180	160	122.5
CPV-1325-2T	1	413	505	735	494	130	364	35	200	103	370	265	200	8	400	380	180	160	125
CPV-1325-4/6T	1	413	505	716	432.5	130	302.5	35	200	103	351	265	200	8	400	380	180	160	113.5
CPV-1630-4T	1	480	602	890	536.5	145	391.5	35	250	117	440	323	250	8	450	430	240	220	142.5
CPV-1630-6T	1	480	602	880	503	145	358	35	250	117	430	323	250	8	450	430	240	220	138
CPV-1942-4T	1	580	750	1170	730.5	210	520.5	60	315	130	600	412.5	315	8	600	564	350	314	181.5
CPV-1942-6/8T	1	580	750	1150	679.5	210	469.5	60	315	130	580	412.5	315	8	600	564	350	314	204

CPV-1030...2045

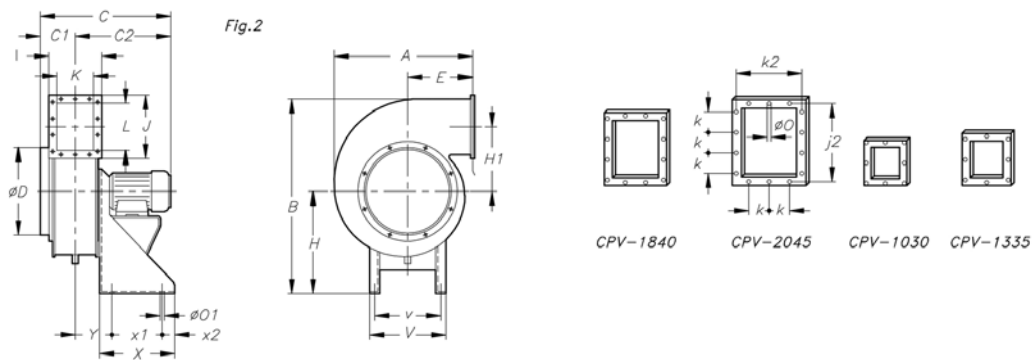

Model	Fig.	A	B	C	C1	C2	øD	E	H	H1	I	J	J2	øK	k	k2	L	øO	øO1	V	v	X	x1	x2	Y
CPV-1335	2	566	788	-	175	-	225	255	452	246	240	256	226	160	100	210	180	9	12	320	285	-	200	50	140
CPV-1840-4T	2	628	819	660	210	450	355	275	420	259	305	356	326	225	100	275	280	9	12	320	285	300	200	50	170
CPV-1840-6T	2	628	809	630	210	420	355	275	410	259	305	356	326	225	100	275	280	9	12	320	285	300	200	50	170
CPV-2045	2	724	1020	810	245	565	400	300	542	310	362	421	381	270	100	322	335	9	12	350	315	350	250	50	197



Dimensions mm

CPV-1160...2160

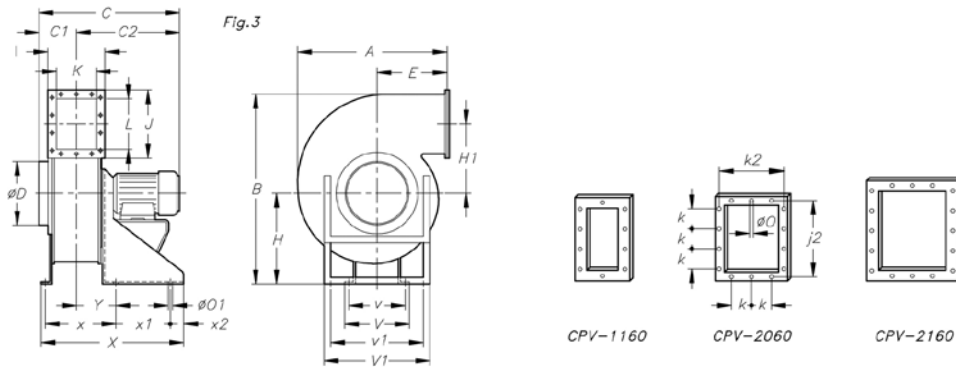

Model	Fig.	A	B	C	C1	C2	øD	E	H	H1	I	J	J2	øK	k	k2	L	øO	øO1	V	V1	v	v1	X	x	x1	x2	Y
CPV-1160	3	937	1276	-	210	-	355	410	720	421	275	416	366	155	100	225	310	9	14	500	790	450	670	710	265	360	60	155
CPV-2060	3	937	1276	-	270	-	400	410	720	421	395	416	366	275	100	345	310	9	14	500	790	450	670	855	410	360	60	215
CPV-2160	3	981	1336	-	285	-	600	414	720	438.5	455	501	451	335	100	405	395	9	14	500	790	450	670	915	470	360	60	240

Characteristic curves

Q= Flow rate in m<sup>3</sup>/h, m<sup>3</sup>/s and cfm.

Pe= Static pressure in mm H<sub>2</sub>O, Pa and inwg.

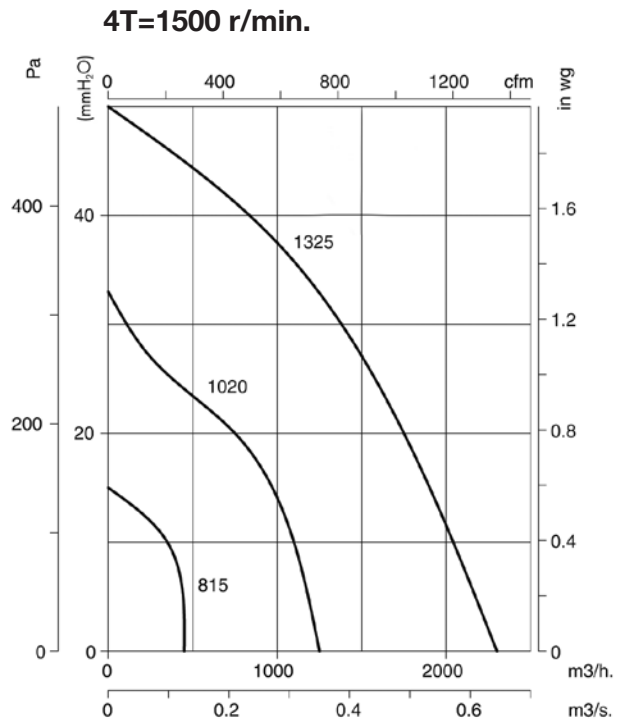
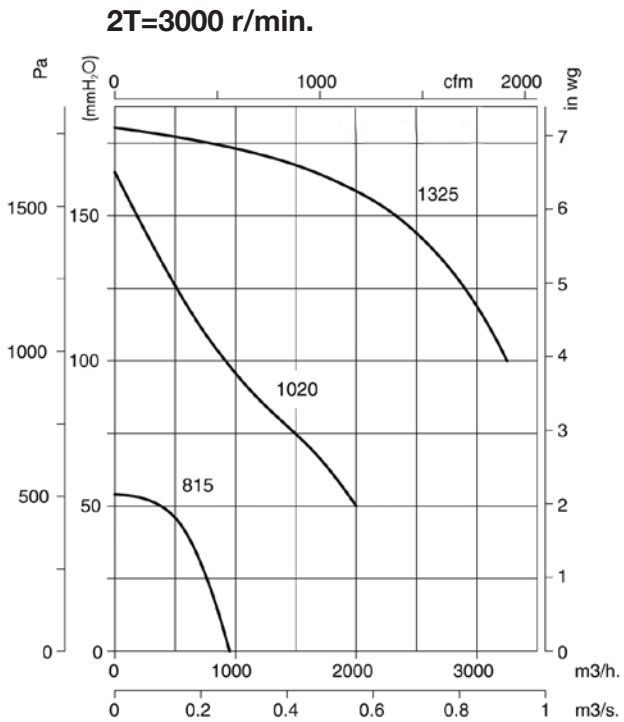

**Characteristic curves**

Q= Flow rate in m<sup>3</sup>/h, m<sup>3</sup>/s and cfm.

Pe= Static pressure in mm H<sub>2</sub>O, Pa and inwg.

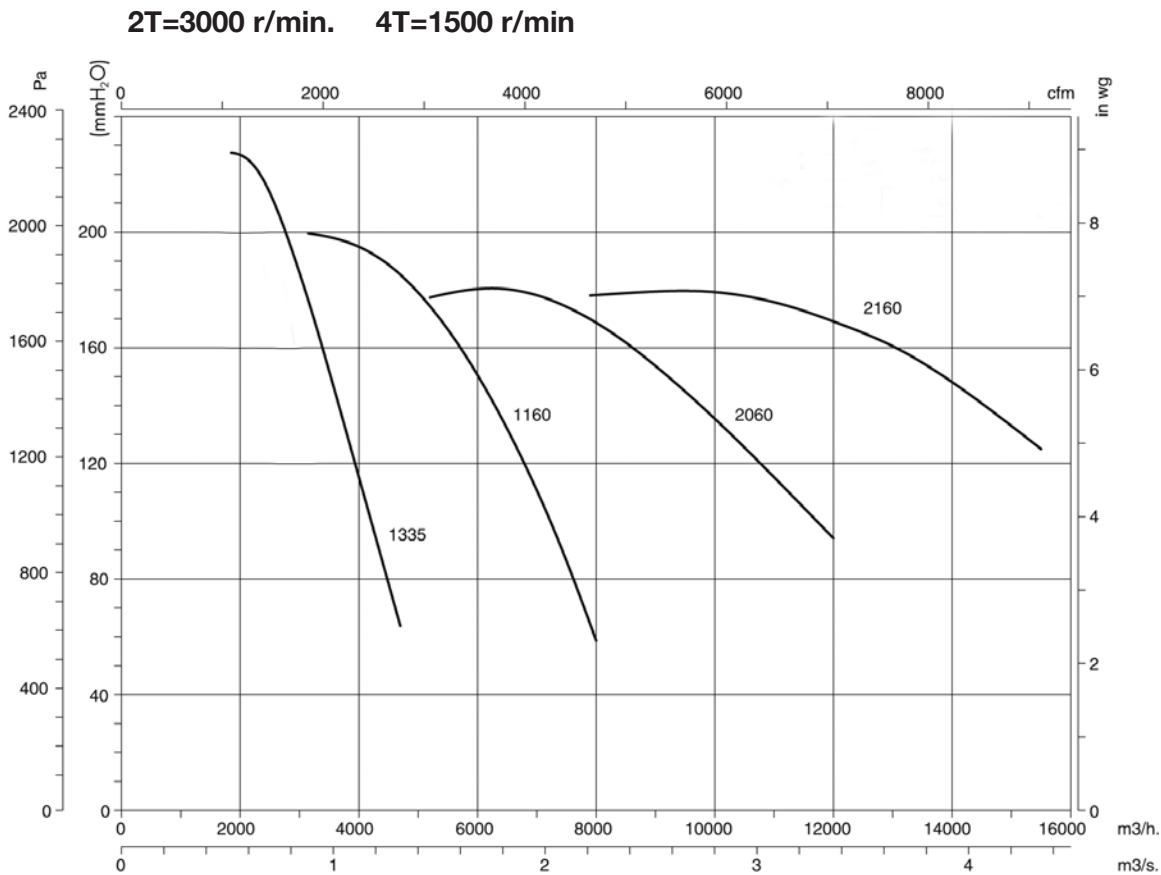
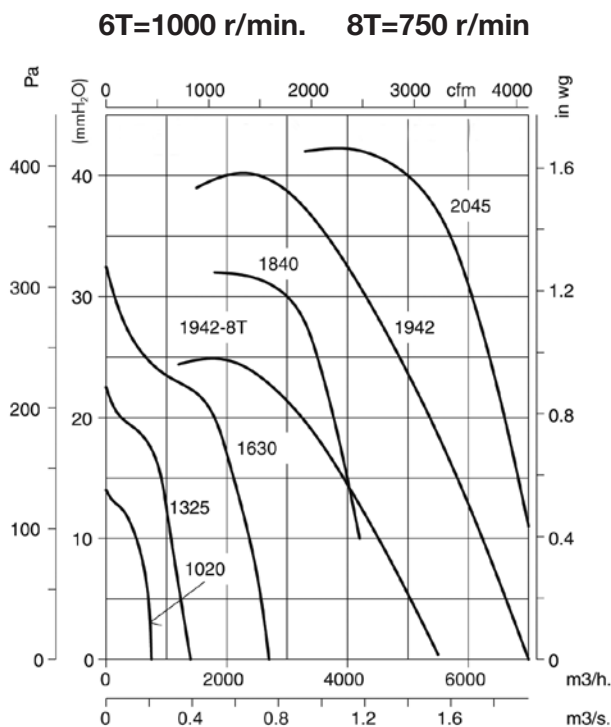
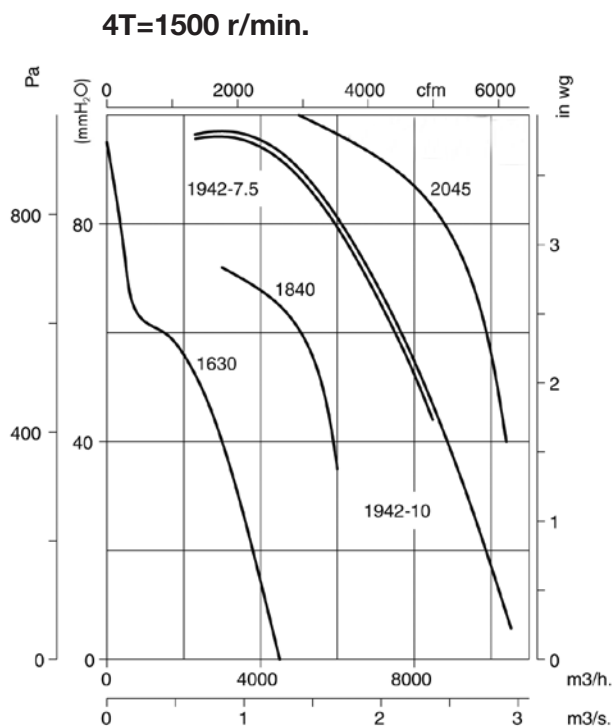

**Characteristic curves**

Q= Flow rate in m<sup>3</sup>/h, m<sup>3</sup>/s and cfm.

Pe= Static pressure in mm H<sub>2</sub>O, Pa and inwg.

**2T=3000 r/min.**

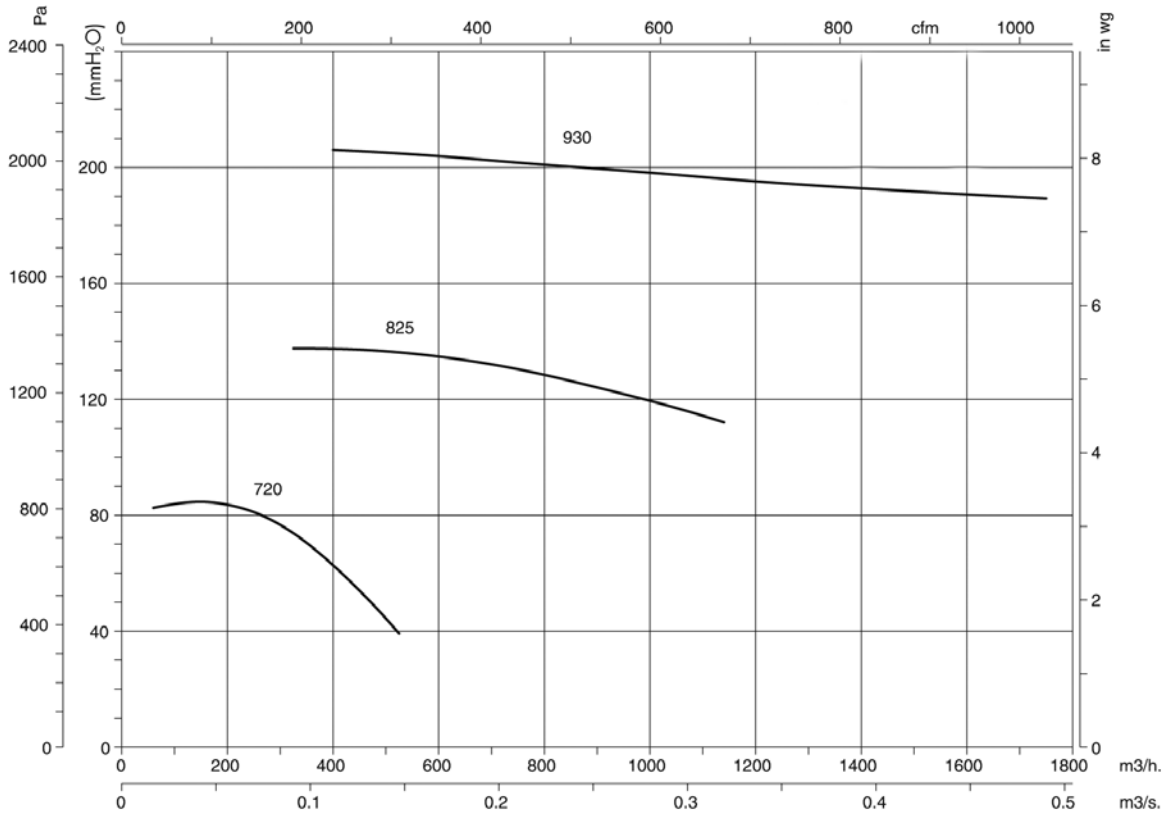

**Orientation**

Standard supply LG 90.



**Accessories**



# CA

## High pressure, single inlet centrifugal fans with cast aluminium casing and impeller



### Fan:

- Cast aluminium casing.
- Cast aluminium impeller.

### Motor:

- IE3 efficiency motors for powers equal to or greater than 0.75kW except single-phase, 2-speed and 8-pole.
- Class F motors with ball bearings and IP55 protection.
- Multi voltage motor, special design valid for 220/380V 60Hz, 254/440V 60Hz, 265/460V 60Hz, 277/480V 60Hz.
- Maximum temperature of air to be carried: -20 °C.+ 120 °C.

### Finish:

- Anti-corrosive finish of polyester resin polymerised at 190 °C, previously degreased with phosphate-free nanotechnological treatment.

### On request:

- Special windings for different voltages.
- Fan prepared for air transmission of up to 250 °C.
- ATEX-certified Category 2.

*Extremely thick aluminium construction to absorb noise and vibrations*

### Order code

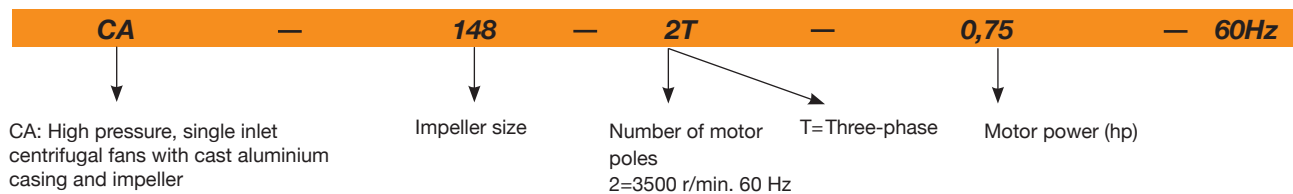

### Technical characteristics

**60Hz**

Model	Speed (r/min)	Max. admissible current (A)		Installed power (kW)	Maximum flow rate (m <sup>3</sup> /h)	Sound pressure level dB(A)	Approx. weight (kg)
		220-277V	380-480V				
CA-234-2T	3444	1.92	1.11	0.37	220	72	10.2
CA-234-2M	3444	2.53		0.37	220	72	10.2
CA-142-2T-0.33	3282	1.29	0.75	0.25	275	73	22.5
CA-142-2T-0.5	3372	1.92	1.11	0.37	350	73	22.5
CA-148-2T-0.75	3396	2.57	1.49	0.55	400	74	28.0
CA-148-2T-1	3408	2.78	1.60	0.75	490	75	30.0
CA-148-2T-1.5	3420	4.20	2.40	1.10	610	76	32.0
CA-154-2T-1.5	3396	4.20	2.40	1.10	600	78	46.0
CA-154-2T-2	3432	5.44	3.13	1.50	800	79	48.5
CA-154-2T-3	3450	7.77	4.47	2.20	1280	80	50.5
CA-160-2T-2	3420	5.44	3.13	1.50	500	83	57.0
CA-160-2T-3	3432	7.77	4.47	2.20	900	84	58.0
CA-166-2T-3	3444	7.77	4.47	2.20	500	84	67.0
CA-166-2T-4	3444	10.18	5.88	3.00	950	85	73.0
CA-166-2T-5.5	3432	13.60	7.82	4.00	1600	86	76.0
CA-172-2T-5.5	3456	13.60	7.82	4.00	1100	87	90.0
CA-172-2T-7.5	3456		10.50	5.50	1710	88	112.0
CA-172-2T-10	3516		14.50	7.50	2300	89	124.0

Acoustic characteristics

Sound power spectrum Lw(A) in dB(A) per Hz frequency band

Model	63	125	250	500	1000	2000	4000	8000	Model	63	125	250	500	1000	2000	4000	8000
234	38	51	65	72	80	79	73	64	160-2	54	67	81	88	96	94	88	80
142	39	52	66	73	81	80	74	65	160-3	55	68	82	89	97	95	89	81
148-0.75	43	56	70	77	85	83	77	69	166-3	55	68	82	89	97	95	89	81
148-1	44	57	71	78	86	84	78	70	166-4	56	69	83	90	98	96	90	82
148-1.5	45	58	72	79	87	85	79	71	166-5.5	57	70	84	91	99	97	91	83
154-1.5	47	60	74	81	89	87	81	73	172-5.5	59	72	86	93	101	100	94	85
154-2	48	61	75	82	90	88	82	74	172-7.5	60	73	87	94	102	101	95	86
154-3	49	62	76	83	91	89	83	75	172-10	61	74	88	95	103	102	96	87

Dimensions mm

**CA-234**

Model	A	A1	B	C	C1	C2	øD	ød	ød1	ød2	E	H	H1	I	J	øK	k	øO	øO1	V	v	x1	Y
CA-234-2T-0.33	376	381	415	272	242.5	29.5	98	130	115	M4	175	225	187	98	63	40	72	9	9	180	120	40	94
CA-234-2M-0.33	376	381	415	272	242.5	29.5	98	130	115	M4	175	225	187	98	63	40	72	9	9	180	120	40	94

**CA-142...172**

Model	A	A1	B	C	C1	C2	øD	ød	ød1	ød2	E	H	H1	I	øK	øk	øO	øO1	V	v	x1	Y
CA-142-2T-0.33	494	488	540	270	221.52	48.5	90	160	130	M8	240	301	235	120	60	90	11	12	300	270	130	51
CA-142-2T-0.5	494	488	540	290	241.5	48.5	90	160	130	M8	240	301	235	120	60	90	11	12	300	270	130	51
CA-142-2T-0.75	563	557.5	639	308.5	251.5	57	100	170	140	M8	270	360	269.5	150	73	110	11	12	330	290	140	60
CA-148-2T-1	563	557.5	639	324.5	267.5	57	100	170	140	M8	270	360	269.5	150	73	110	11	12	330	290	140	60
CA-148-2T-1.5	563	557.5	639	324.5	267.5	57	100	170	140	M8	270	360	269.5	150	73	110	11	12	330	290	140	60
CA-154-2T-1.5	630	625	708	348	268.5	79.5	115	183	155	M10	300	395	308	160	80	120	13	12	356	320	210	62
CA-154-2T-2	630	625	708	371	291.5	79.5	115	183	155	M10	300	395	308	160	80	120	13	12	356	320	210	62
CA-154-2T-3	630	625	708	396	316.5	79.5	115	183	155	M10	300	395	308	160	80	120	13	12	356	320	210	62
CA-160-2T-2	708	699	785	381	291	90	130	230	192	M10	336	440	338	160	85	120	13	12	373	322	220	62
CA-160-2T-3	708	699	785	406	316	90	130	230	192	M10	336	440	338	160	85	120	13	12	373	322	220	62
CA-166-2T-3	759	752	866	399	319.5	79.5	140	230	200	M10	364	490	372	160	85	120	13	12	450	400	245	70
CA-166-2T-4	759	752	866	423	343.5	79.5	140	230	200	M10	364	490	372	160	85	120	13	12	450	400	245	70
CA-166-2T-5.5	759	752	866	445	365.5	79.5	140	230	200	M10	364	490	372	160	85	120	13	12	450	400	265	70
CA-172-2T-5.5	818	813	923	451	371	80	148	230	200	M10	390	516	404	175	90	140	13	12	450	400	260	78
CA-172-2T-7.5	818	813	923	492	412	80	148	230	200	M10	390	516	404	175	90	140	13	12	450	400	300	78
CA-172-2T-10	818	813	923	492	412	80	148	230	200	M10	390	516	404	175	90	140	13	12	450	400	300	78

**Characteristic curves**

Q= Flow rate in m<sup>3</sup>/h, m<sup>3</sup>/s and cfm.

Pe= Static pressure in mm H<sub>2</sub>O, Pa and inwg.

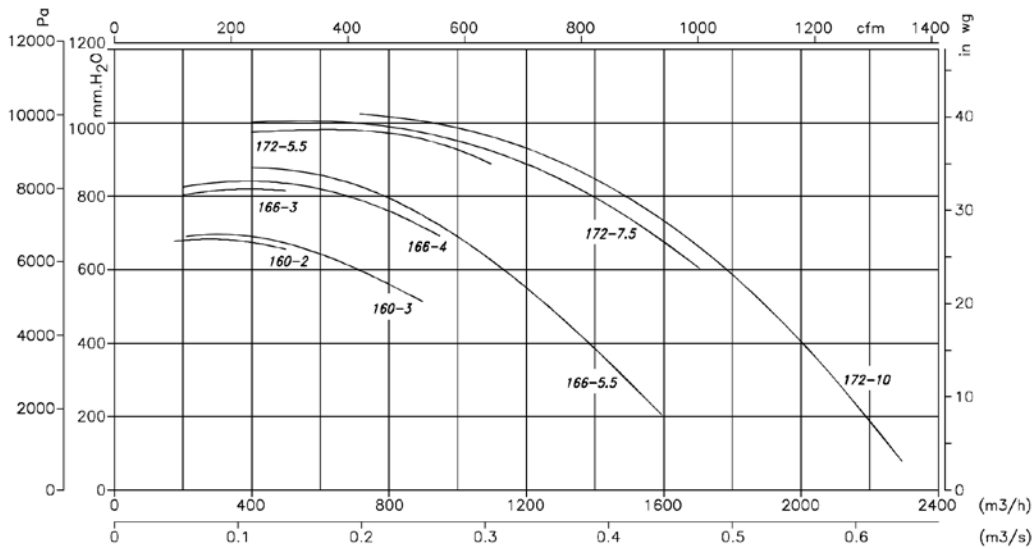
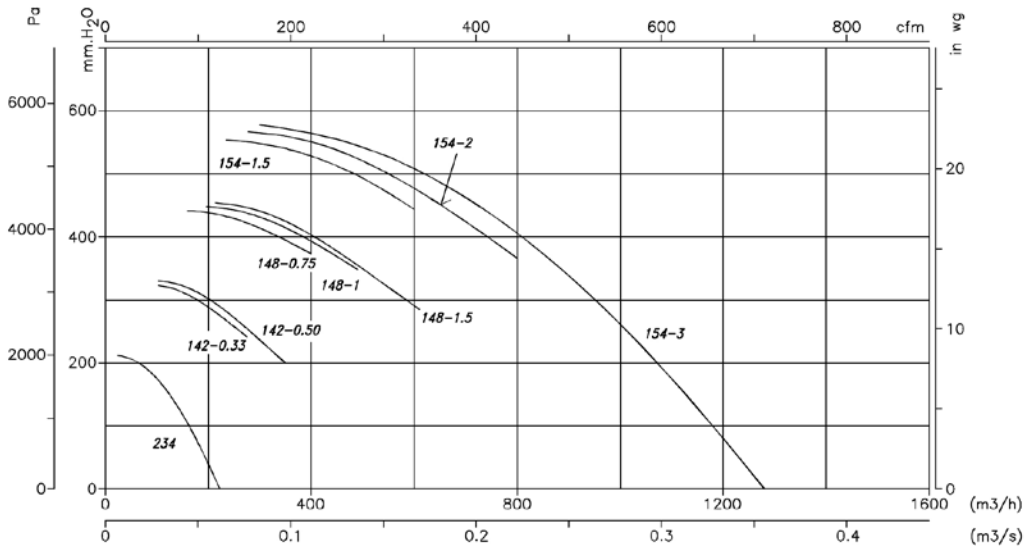

**Orientation**

Standard supply LG 270.

LG 180 positions on request and with special anchoring measurements.



**Accessories**

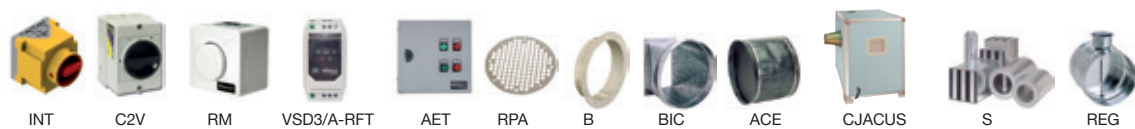

# CAS CAS-S



**CAS: High pressure, single inlet centrifugal fans with sheet steel casing and impeller**

**CAS-S: High pressure, single inlet centrifugal fans with sheet steel casing and impeller, fitted with acoustic attenuators**

**Fan:**

- Sheet steel casing.
- Backward-curved impeller made of galvanised sheet steel, except models 242-248-254-260-640-645-650 with cast aluminium impeller.
- CAS-S: Hexagonal profile acoustic attenuator built into the fan intake nozzle. Its design permits the adjustment of the air flow at the fan entrance.

**Motor:**

- IE3 efficiency motors for powers equal to or greater than 0.75kW except single-phase, 2-speed and 8-pole.
- Class F motors with ball bearings and IP55 protection.
- Multi voltage motor, special design valid for 220/380V 60Hz, 254/440V 60Hz, 265/460V 60Hz, 277/480V 60Hz.
- Maximum temperature of air to be carried: -20 °C.+ 120 °C.

**Finish:**

- Anti-corrosive finish of polyester resin polymerised at 190 °C, previously degreased with phosphate-free nanotechnological treatment.

**On request:**

- Special windings for different voltages.
- Fan prepared for air transmission of up to 250 °C.
- Stainless steel fan.
- ATEX-certified Category 2.

**Order code**

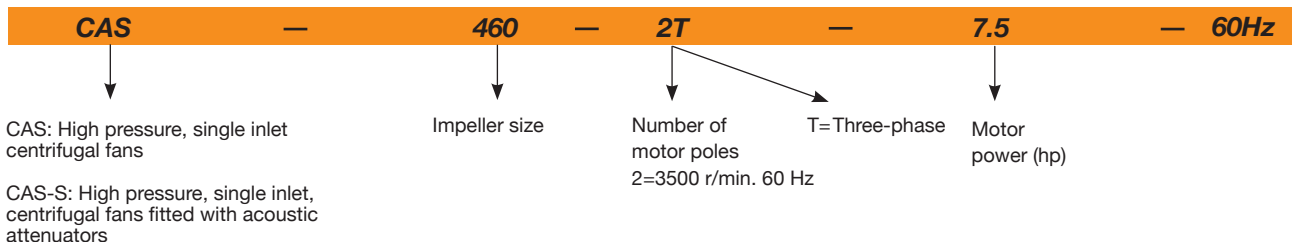

**Technical characteristics**

60Hz

Model	Speed (r/min)	Max. admissible current (A)		Installed power (kW)	Maximum flow rate (m³/h)	Sound pressure level dB(A)		Approx. weight (Kg)	
		220-277V	380-480V			CAS	CAS-S	CAS	CAS-S
CAS-242-2T-0.33	3396	1.39	0.8	0.25	450	73	67	30	33
CAS-242-2T-0.5	3288	1.92	1.11	0.37	650	73	67	31	34
CAS-248-2T-0,75	3360	2.42	1.4	0.55	420	74	68	43.5	46.5
CAS-248-2T-1	3426	3	1.73	0.75	500	75	69	45	48
CAS-248-2T-1.5	3414	4.16	2.4	1.1	990	76	70	46.5	49.5
CAS-254-2T-1.5	3414	4.16	2.4	1.1	600	76	70	56.5	59.5
CAS-254-2T-2	3432	5.63	3.25	1.5	800	78	72	61.5	64.5
CAS-254-2T-3	3456	7.97	4.6	2.2	1300	80	73	63	66
CAS-260-2T-2	3432	5.63	3.25	1.5	500	77	71	75	80
CAS-260-2T-3	3456	7.97	4.6	2.2	900	79	72	78	83
CAS-463-2T-5.5	3480	13.34	7.7	4	1150	82	75	88.5	93.5
CAS-463-2T-7.5	3426		10.5	5.5	2000	83	76	95.5	100.5
CAS-467-2T-7.5	3426		10.5	5.5	1550	84	77	117.5	122.5
CAS-467-2T-10	3426		13.9	7.5	2600	85	78	122.5	127.5
CAS-571-2T-10	3426		13.9	7.5	2000	86	78	144	149
CAS-571-2T-15	3516		20	11	3450	87	79	175	180

### Technical characteristics

Model	Speed (r/min)	Max. admissible current (A)		Installed power (kW)	Maximum flow rate (m³/h)	Sound pressure level dB(A)		Approx. weight (Kg)	
		220-277V	380-480V			CAS	CAS-S	CAS	CAS-S
CAS-640-2T-2	3432	5.63	3.25	1.5	2600	77	71	51.5	56.5
CAS-645-2T-3	3456	7.97	4.6	2.2	2000	76	70	62.5	70.5
CAS-645-2T-4	3474	10.57	6.1	3	3000	81	74	69.5	77.5
CAS-650-2T-5.5	3480	13.34	7.7	4	3500	81	74	89	97
CAS-650-2T-7.5	3426		10.5	5.5	4750	83	76	96	104
CAS-852-2T-7.5	3426		10.5	5.5	3500	81	74	96	104
CAS-852-2T-10	3426		13.9	7.5	5500	85	78	101	109
CAS-856-2T-15	3516		20	11	7500	85	78	157.5	167.5
CAS-863-2T-15	3516		20	11	4000	84	77	168	178
CAS-863-2T-20	3504		26.5	15	7000	86	78	179	189
CAS-971-2T-25	3504		32	18.5	5800	87	79	299	309
CAS-971-2T-30	3516		39	22	8100	88	80	324	334
CAS-971-2T-40	3546		53	30	12000	89	81	380	390
CAS-1250-2T-15/A	3516		20	11	12000	84	77	220	230
CAS-1456-2T-25/A	3504		32	18.5	18000	87	79	286	299
CAS-1663-2T-50/A	3540		64	37	25000	92	84	425	438
CAS-1671-2T-60/A	3528		80	45	27000	93	85	575	590
CAS-2071-2T-100/A	3564		127	75	33600	95	86	750	770
CAS-2080-2T-125/A	3564		152	90	42600	96	87	820	840
CAS-790-2T-20	3504		26.5	15	2100	88	80	245	250
CAS-980-2T-30	3516		39	22	4800	87	79	340	355
CAS-990-2T-50	3540		64	37	6000	90	82	485	500
CAS-1080-2T-40	3546		53	30	5400	88	80	420	435
CAS-1090-2T-60	3552		79	45	6000	91	83	530	545

### Acoustic characteristics

Sound power spectrum Lw(A) in dB(A) per Hz frequency band

Model	63	125	250	500	1000	2000	4000	8000	Model	63	125	250	500	1000	2000	4000	8000
<b>CAS</b>									<b>852-7.5</b>								
242	50	61	67	76	83	82	79	72	852-10	68	76	86	93	96	96	92	84
248-0.75	51	62	68	77	84	83	80	73	856	63	76	90	96	96	94	90	84
248-1	52	63	69	78	85	84	81	74	863-15	67	81	87	96	96	95	92	87
248-1.5	53	64	70	79	86	85	82	75	863-20	69	81	92	99	98	95	93	87
254-1.5	55	66	71	81	88	87	84	77	971-25	67	81	90	102	98	96	93	89
254-2	57	68	73	83	90	89	86	79	971-30	68	82	91	103	99	97	94	90
254-3	56	68	76	85	90	92	89	82	971-40	68	83	97	102	102	99	95	88
260-2	53	69	69	83	88	88	85	78	1250	75	88	97	94	91	86	82	73
260-3	55	71	71	85	90	90	87	80	1456	80	93	102	99	96	90	87	78
463-5.5	57	69	82	91	93	93	89	80	1663	65	74	80	95	108	100	97	93
463-7.5	58	70	83	92	94	94	90	81	1671	64	73	79	94	108	100	97	93
467-7.5	69	74	83	95	95	97	93	85	2071	66	75	81	96	110	102	99	95
467-10	70	75	84	96	96	98	94	86	2080	67	76	82	97	111	103	100	96
571-10	64	76	86	96	99	99	94	86	680	70	74	85	96	102	93	86	80
571-15	65	77	87	97	100	100	95	87	790	73	77	88	99	105	96	89	83
640	56	67	75	82	88	84	83	76	980	61	70	76	91	105	97	94	90
645-3	55	66	74	81	87	83	82	75	990	64	73	79	94	108	100	97	93
645-4	55	66	77	86	90	91	87	79	1080	62	71	77	92	106	98	95	91
650-5.5	59	75	84	90	93	90	85	78	1090	65	77	80	95	109	101	98	94
650-7.5	52	68	81	91	96	93	85	78									

Model	63	125	250	500	1000	2000	4000	8000	Model	63	125	250	500	1000	2000	4000	8000
<b>CAS-S</b>									<b>852-7.5</b>								
242	44	55	61	70	77	76	73	66	852-10	61	65	75	81	85	85	82	77
248-0.75	45	56	62	71	78	77	74	67	856	56	69	83	89	89	87	83	77
248-1	46	57	63	72	79	78	75	68	863-15	60	74	80	89	89	88	85	80
248-1.5	47	58	64	73	80	79	76	69	863-20	61	73	84	91	90	87	85	79
254-1.5	49	60	65	75	82	81	78	71	971-25	59	73	82	94	90	88	85	81
254-2	51	62	67	77	84	83	80	73	971-30	60	74	83	95	91	89	86	82
254-3	49	61	69	78	83	85	82	75	971-40	60	75	89	94	94	91	87	80
260-2	47	63	63	77	82	82	79	72	1250	68	81	90	87	84	79	75	66
260-3	48	64	64	78	83	83	80	73	1456	72	85	94	91	88	82	79	70
463-5.5	50	62	75	84	86	86	82	73	1663	57	66	72	87	100	92	89	85
463-7.5	51	63	76	85	87	87	83	74	1671	56	65	71	86	100	92	89	85
467-7.5	62	67	76	88	88	90	86	78	2071	57	66	72	87	101	93	90	86
467-10	63	68	77	89	89	91	87	79	2080	58	67	73	88	102	94	91	87
571-10	56	68	78	88	91	91	86	78	680	62	66	77	88	94	85	78	72
571-15	57	69	79	89	92	92	87	79	790	65	69	80	91	97	88	81	75
640	50	61	69	76	82	78	77	70	980	53	62	68	83	97	89	86	82
645-3	49	60	68	75	81	77	76	69	990	56	65	71	86	100	92	89	85
645-4	48	59	70	79	83	84	80	72	1080	54	63	69	84	98	90	87	83
650-5.5	52	68	77	83	86	83	78	71	1090	57	66	72	87	101	93	90	86
650-7.5	45	61	74	84	89	86	78	71									



Dimensions mm

CAS-242...971

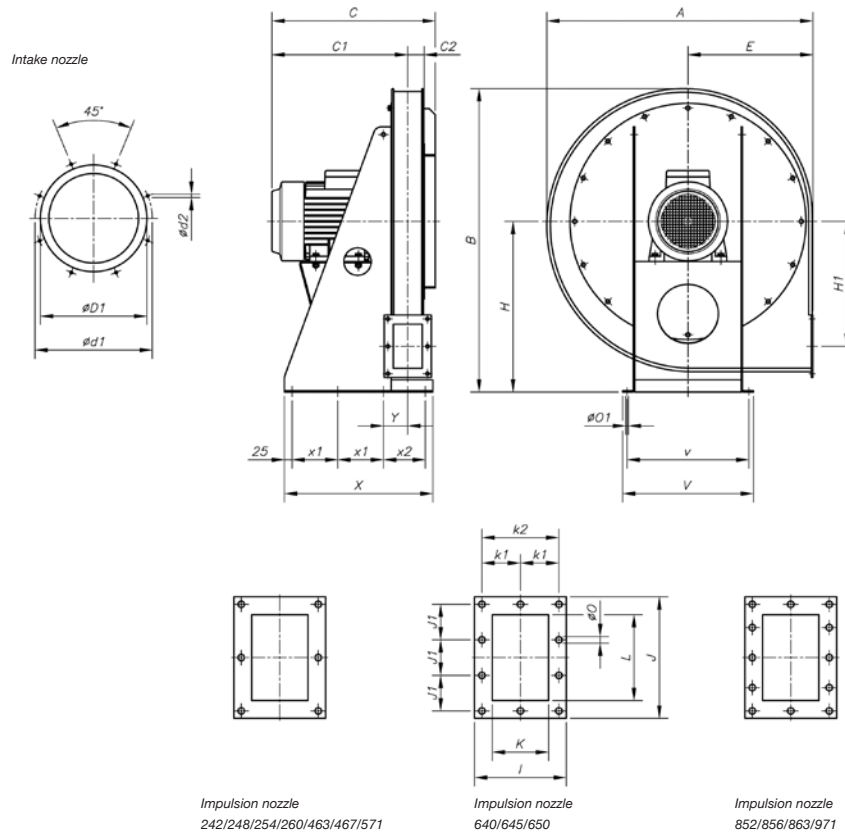

Impulsion nozzle  
242/248/254/260/463/467/571

Impulsion nozzle  
640/645/650

Impulsion nozzle  
852/856/863/971

Model	A	B	C	C1	C2	øD1	ød1	ød2	E	H	H1	I	J	J1	K	k1	k2	L	ø0	ø01	V	v	X	x1	x2	Y
CAS-242-2T-0.33	576	662	282	219	33	100	130	M8	270	375	270	120	155	65	60	-	95	95	11	12	305	275	260	75	-	61
CAS-242-2T-0.5	576	662	310	247	5	100	130	M8	270	375	270	120	155	65	60	-	95	95	11	12	305	275	260	75	-	61
CAS-248-2T-0.75	639	728	315	249	75	112	140	M8	300	410	297	126	165	70	66	-	101	105	11	12	320	290	300	90	-	64
CAS-248-2T-1/1.5	639	728	340	274	36	112	140	M8	300	410	297	126	165	70	66	-	101	105	11	12	320	290	300	90	-	64
CAS-254-2T-1.5	699	788	365	294.5	40.5	125	155	M8	330	440	322	135	175	75	75	-	110	115	11	14	340	310	330	100	-	68.5
CAS-254-2T-2	699	788	413	342.5	40.5	125	155	M8	330	440	322	135	175	75	75	-	110	115	11	14	340	310	330	100	-	68.5
CAS-254-2T-3	699	788	443	372.5	40.5	125	155	M8	330	440	322	135	175	75	75	-	110	115	11	14	340	310	330	100	-	68.5
CAS-260-2T-2/3	782	875	419	343.5	47.5	150	175	M8	370	485	362	145	185	80	85	-	120	125	11	14	380	350	370	115	-	73.5
CAS-463-2T-5.5	782	875	459	383.5	45.5	200	240	M8	370	485	362	145	185	80	85	-	120	125	11	14	380	350	370	115	-	73.5
CAS-463-2T-7.5	782	875	517	441.5	45.5	200	240	M8	370	485	362	145	185	80	85	-	120	125	11	14	380	350	370	115	-	73.5
CAS-467-2T-7.5/10	833	945	530	442	48	224	258	M8	390	530	395	150	190	82.5	90	-	125	130	11	14	405	375	300	125	-	76
CAS-571-2T-10	873	995	536	445.5	50.5	250	275	M8	410	560	410	155	205	90	95	-	130	145	11	14	430	400	350	150	-	79.5
CAS-571-2T-15	873	995	671	580.5	50.5	250	275	M8	410	560	410	155	205	90	95	-	130	145	11	14	430	400	410	180	-	79.5
CAS-640-2T-2	639	728	446	350.5	65.5	250	275	M8	300	410	250	185	260	78	125	80	-	200	11	14	340	310	350	100	-	93.5
CAS-645-2T-3	699	788	461	358	73	250	275	M8	330	440	267.5	200	284	86	140	87.5	-	224	11	14	380	350	380	115	-	101
CAS-645-2T-4	699	788	491	388	73	250	275	M8	330	440	267.5	200	284	86	140	87.5	-	224	11	14	380	350	380	115	-	101
CAS-650-2T-5.5	782	875	534	421	83	250	275	M8	370	485	300	220	310	95	160	97.5	-	250	11	14	405	375	490	125	190	111
CAS-650-2T-7.5	782	875	572	459	83	250	275	M8	370	485	300	220	310	95	160	97.5	-	250	11	14	405	375	490	125	190	111
CAS-852-2T-7.5/10	833	945	603	470	94.5	380	310	M8	390	530	320	240	340	78	180	107.5	-	280	11	14	430	400	540	150	190	122
CAS-856-2T-15	833	945	708	575	93	355	395	M8	390	530	320	240	340	78	180	107.5	-	280	11	14	430	400	600	180	190	122
CAS-863-2T-15/20	873	995	728	585	103	355	410	M8	410	560	325	260	375	87.5	200	117.5	-	315	11	14	430	400	620	180	210	132
CAS-971-2T-25	1012	1170	759	598	116	400	450	M10	460	670	420	294	425	100	224	132	-	355	11	14	550	510	500	150	150	145
CAS-971-2T-30	1012	1170	881	720	116	400	450	M10	460	670	420	294	425	100	224	132	-	355	11	14	550	510	500	150	150	145
CAS-971-2T-40	1012	1170	948	787	116	400	450	M10	460	670	420	294	425	100	224	132	-	355	11	14	550	510	500	150	150	145

Dimensions mm

CAS-1250...2080

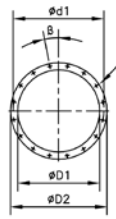

Intake nozzle

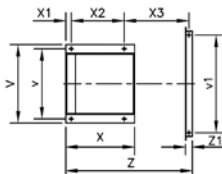
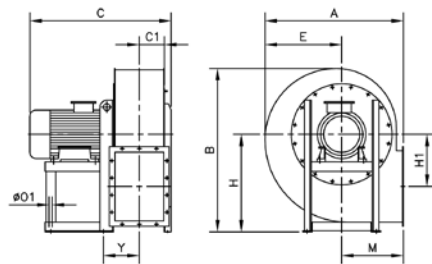

Impulsion nozzle  
CAS-1250-2T-15/A  
CAS-1456-2T-25/A  
CAS-1663-2T-50/A

Impulsion nozzle  
CAS-1671-2T-60/A  
CAS-2071-2T-100/A  
CAS-2080-2T-125/A

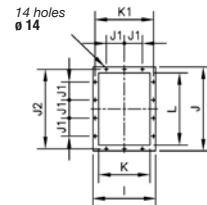
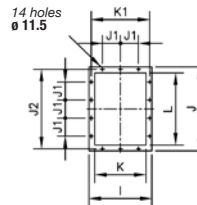

Model	A	B	C	C1	$\phi D1$	$\phi D2$	$\phi d1$	x $\phi$	B	E	H	H1	I	J	J1	J2	K	K1	L	M	$\phi O1$	V	v	v1	X	X1	X2	X3	Y	Z	Z1
CAS-1250-2T-15/A	865	1055	885	160	361	441	405	8x11.5	22°30'	510	630	365	360	480	125	448	280	332	400	355	14	440	400	-	425	30	340	-	202	-	-
CAS-1456-2T-25/A	970	1185	900	163	456	535	497	12x12	15°	555	710	410	395	530	125	497	315	366	450	400	14	440	400	-	425	30	340	-	219	-	-
CAS-1663-2T-50/A	1010	1280	1035	183	568	668	629	16x11.5	11°15'	560	800	380	435	580	125	551	355	405	500	450	16	570	510	-	500	40	385	-	263	-	-
CAS-1671-2T-60/A	1130	1340	1160	206	638	738	698	16x13	11°15'	630	800	430	500	660	160	629	400	464	560	500	19	626	565	800	550	40	425	530	292	1025	60
CAS-2071-2T-100/A	1130	1340	1290	206	638	738	698	16x13	11°15'	630	800	430	500	660	160	629	400	464	560	500	21	760	680	800	700	50	550	545	307	1125	60
CAS-2080-2T-125/A	1270	1505	1345	231	718	818	775	16x13	11°15'	710	900	486	550	730	160	698	450	513	630	560	24	760	680	900	700	50	550	595	333	1225	60

CAS-680...1090

Intake nozzle

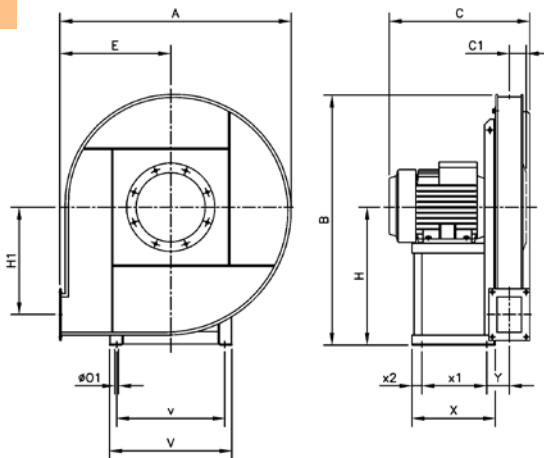
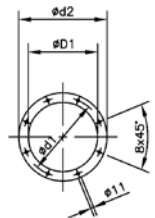

Impulsion nozzle  
CAS-680/790

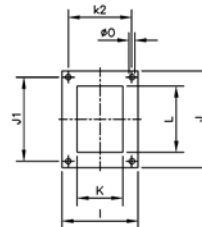

Impulsion nozzle  
CAS-980...1090

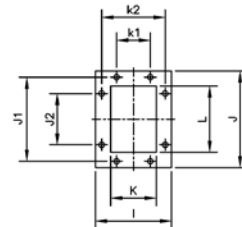

Model	A	B	C	C1	$\phi D1$	$\phi d1$	$\phi d2$	E	H	H1	I	J	J1	J2	K	k1	k2	L	$\phi O$	$\phi O1$	V	v	X	x1	x2	Y
CAS-790-2T-20	1100	1180	650	58	185	219	255	530	630	520	140	172	140	-	80	-	112	112	9	14	440	400	425	340	30	103
CAS-980-2T-30	1120	1250	725	90	255	292	325	530	710	530	210	270	241	112	140	112	182	200	11.5	14	440	400	425	340	35	145
CAS-990-2T-50	1250	1400	900	100	286	332	366	600	800	600	230	294	265	112	160	112	200	224	11.5	16	570	510	500	385	40	165
CAS-1080-2T-40	1120	1250	850	90	255	392	325	530	710	530	210	270	241	112	140	112	182	200	11.5	16	570	510	500	385	40	155
CAS-1090-2T-60	1250	1400	930	100	286	332	366	600	800	600	230	294	265	112	160	112	200	224	11.5	16	626	565	550	425	40	175

CAS-S

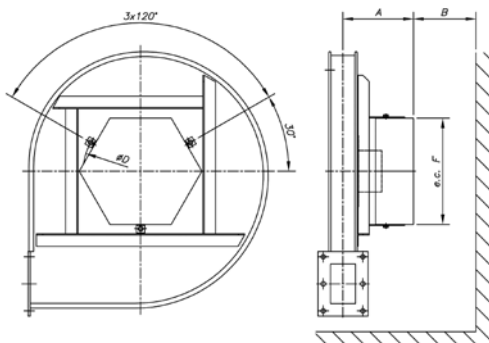

Model	A	B	$\phi D$	F	Model	A	B	$\phi D$	F
CAS-S-242	155	150	276	255	CAS-S-971	327	200	759	655
CAS-S-248	158	150	276	255	CAS-S-1250/A	371	200	683	655
CAS-S-254	162	150	276	255	CAS-S-1456/A	230	200	804	775
CAS-S-260	249	150	371	350	CAS-S-1663/A	234	200	804	775
CAS-S-463	247	150	371	350	CAS-S-680	251	200	371	350
CAS-S-467	249	150	371	350	CAS-S-790	259	200	371	350
CAS-S-571	251	150	371	350	CAS-S-980	290	200	581	560
CAS-S-640	267	150	371	350	CAS-S-990	300	200	581	560
CAS-S-645	275	200	581	560	CAS-S-1080	290	200	581	560
CAS-S-650	295	200	661	560	CAS-S-1090	300	200	581	560
CAS-S-852	305	200	661	560	CAS-S-1671/A	437	200	804	775
CAS-S-856	304	200	683	655	CAS-S-2071/A	437	200	804	775
CAS-S-863	314	200	758	655	CAS-S-2080/A	462	200	884	855

**Characteristic curves**

Q= Flow rate in m<sup>3</sup>/h, m<sup>3</sup>/s and cfm.

Pe= Static pressure in mm H<sub>2</sub>O, Pa and inwg.

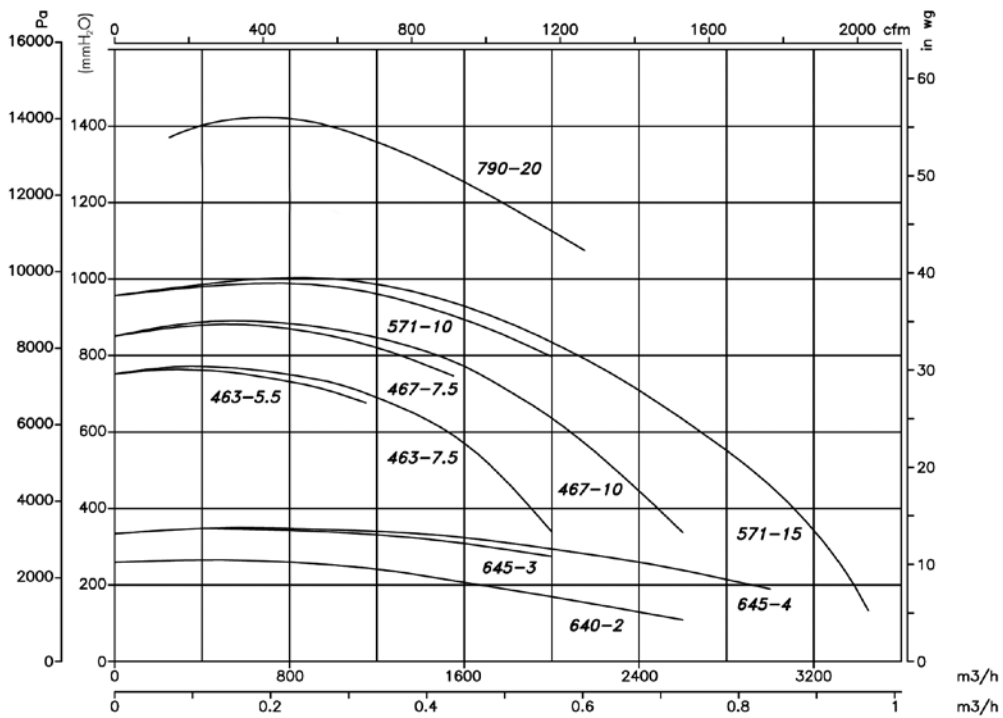
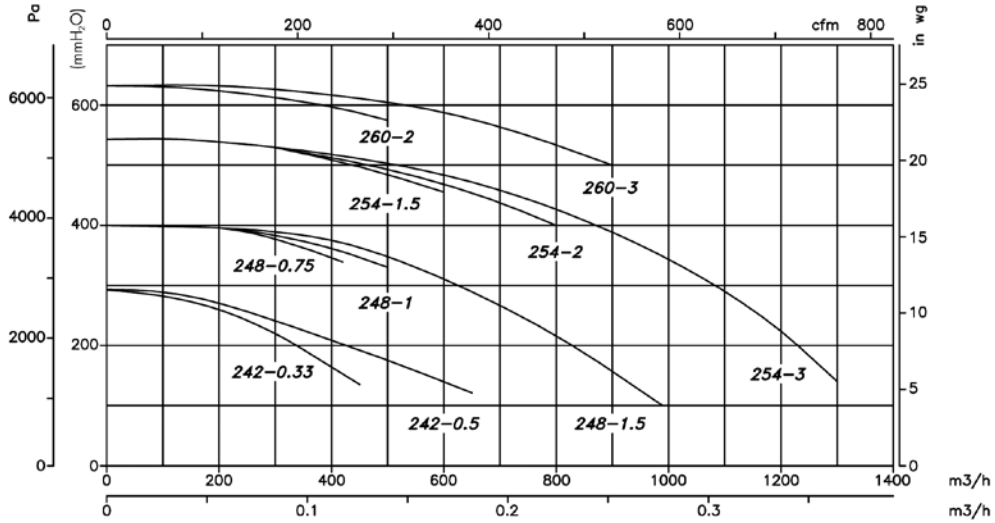

**Characteristic curves**

Q= Flow rate in m<sup>3</sup>/h, m<sup>3</sup>/s and cfm.

Pe= Static pressure in mm H<sub>2</sub>O, Pa and inwg.

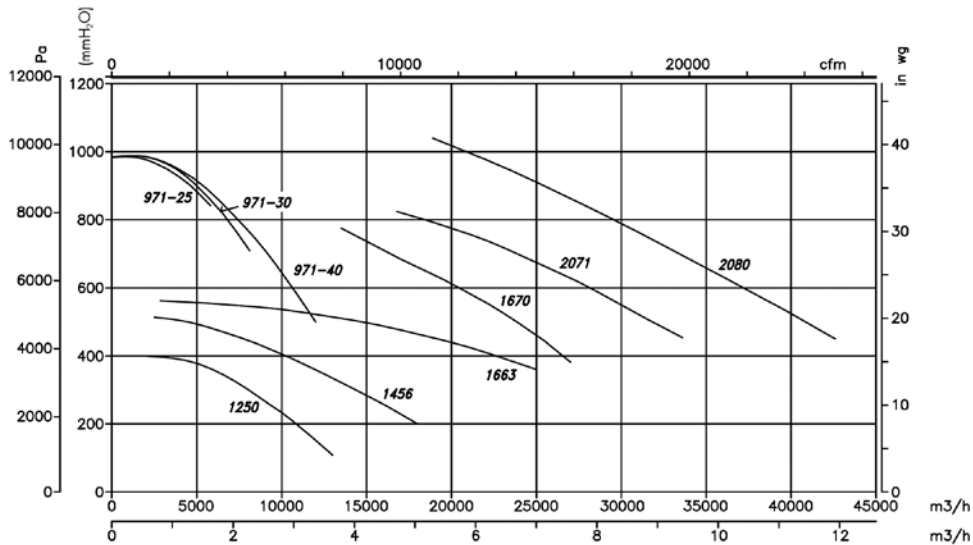
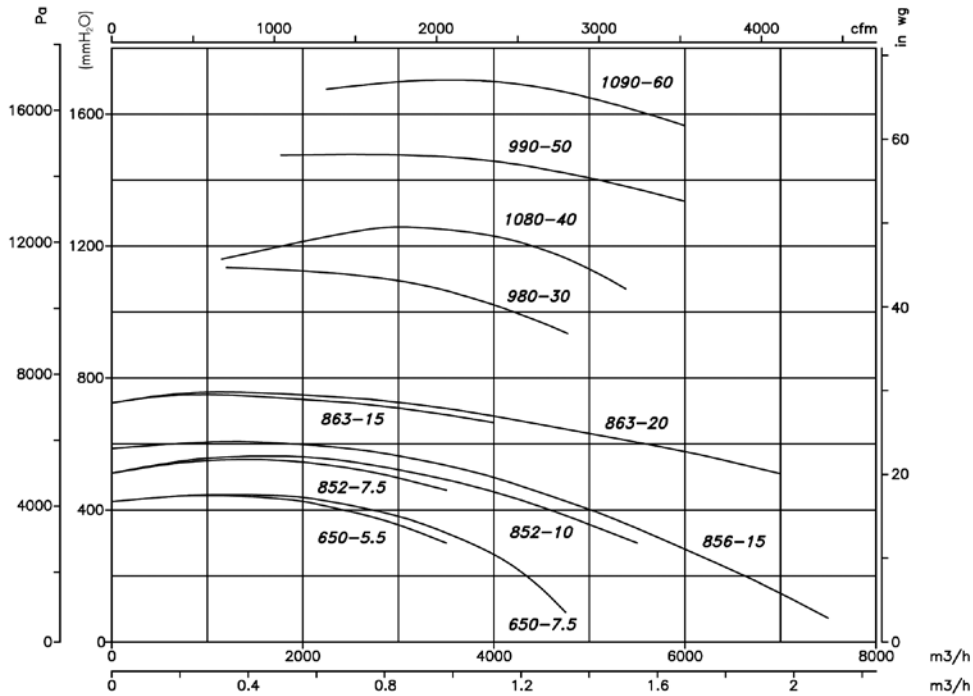

**Orientation**

Standard supply LG 270  
 LG 180 positions on request  
 and with special anchoring  
 measurements.



Supply on request  
 RD 180 positions with special  
 anchoring measurements.





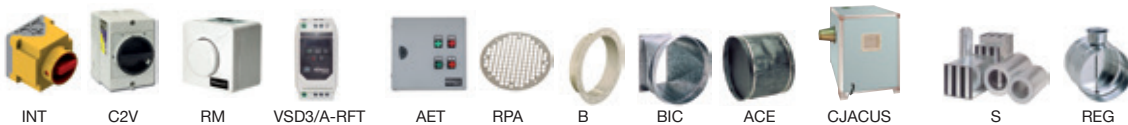





**Accessories**



**ROOF-MOUNTED EXTRACTOR FANS**

205

<p><b>VC-HDU</b></p>  <p>Centrifugal roof-mounted extractor fans, with vertical air outlet</p> <p>208</p>	<p><b>CXT</b></p>  <p>Roof-mounted, belt-driven centrifugal fans with a vertical or horizontal air impulsion design</p> <p>217</p>	<p><b>RFH</b></p>  <p>400 °C/2h centrifugal roof-mounted extractor fans, with horizontal air outlet</p> <p>222</p>	<p><b>RFV</b></p>  <p>400 °C/2h centrifugal roof-mounted extractor fans, with vertical air outlet</p> <p>222</p>	<p><b>CRF</b></p>  <p>Roof-mounted centrifugal extractor fans, with low noise level</p> <p>227</p>
<p><b>HT</b></p>  <p>Roof-mounted axial extractor fans with flat bases</p> <p>230</p>	<p><b>HTMH</b></p>  <p>Roof-mounted multifunctional extractor fans for large flow rates</p> <p>233</p>	<p><b>HTMV</b></p>  <p>Roof-mounted axial extractor fans with vertical air outlet</p> <p>240</p>		

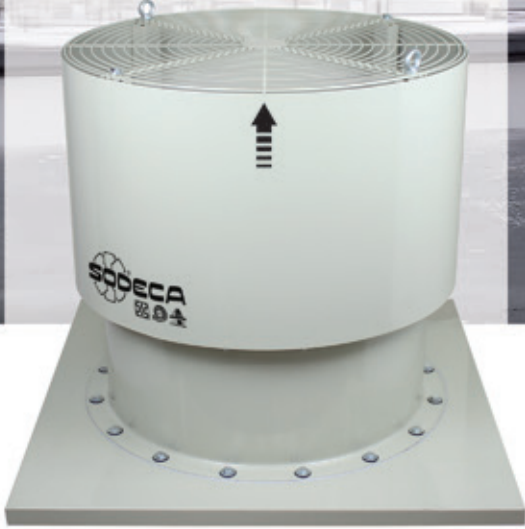

# EXTRACTION SYSTEMS WITH ROOF-MOUNTED FANS



Roof-mounted fans eliminate the harmful effects created when high temperatures and humidity make work and physical effort difficult. They also help extend the life of the structural elements of buildings and warehouses by preventing condensation and humidity. An adequate ventilation system in industrial buildings will considerably reduce cooling and heating expenditure. This type of system easily, continuously and effectively eliminates heat and humidity.

The Sodeca roof-mounted extractors and fans can be adapted to any type of roof. Their different models offer the perfect solution for each installation, thus optimising its operation.



**EFFICIENT WORK**

FAN TYPE	MOTOR TYPE	ENERGY REQUIRED	ENERGY SAVE
EW	IE4+VSD	+++	45%
/EW	IE4+VSD	+++	45%
	IE2	+	0%
	IE2	+	0%

Additional labels in the image include 'BRUSHLESS IE4' and 'EFFICIENT WORK'.

## ENERGY SAVINGS

The Sodeca EFFICIENT WORK fans, which have built-in next generation IE4 E.C. high-performance motors, are designed to reduce the daily energy consumption by around 45%. In addition, they can be controlled with intelligent ventilation systems that determine the ventilation needs appropriate at any given time, thus reducing energy consumption as much as possible.



## SAFETY IN THE EVENT OF FIRE

The fire protection standards make it obligatory to apply temperature control and smoke extraction systems in accordance with standard UNE / EN-23585, calculation and design requirements and methods for planning a temperature control and smoke extraction system in the event of fire. To provide a solution to the needs established by this standard, approved roof-mounted fans exist for this purpose, pursuant to standard EN-12101-3 with an F-400 (400 °C/2h) or F-300 (300 °C/2h) certificate.



## COMFORT AND NOISE REDUCTION

A working environment with the appropriate conditions of comfort is absolutely necessary to ensure an efficient job performance. The installation of outdoor fans brings greater comfort to work zones, reducing noise and the occupation of space in industrial buildings.



## REDUCTION IN HEAT AND MOISTURE

The hot air generated by indoor activity and heating of the roof due to solar radiation transform the roofs of industrial buildings into huge radiators that give off heat, which is transferred to work areas, increasing the temperature and the electricity bill due to a greater need for cooling. Furthermore, in colder climates, condensation increases the moisture level, saturating the insulation material of roofs and reducing their efficiency. A good ventilation system helps prevent all these effects which are harmful to the building structure and to people's health.



## MAINTENANCE AND CLEANING

It is very important for roof-mounted fans to be easy to clean, as they are very difficult to access. The maintenance of all the extraction system elements is essential and very important to achieve a high standard of cleaning and obtain the required grade of hygiene in each installation, thus preventing the possibility of handling contaminated air particles. Ease in the maintenance and installation of roof equipment leads to important cost savings, which is a factor to be considered.



# VC-HDU

## Centrifugal roof-mounted extractor fans, with vertical air outlets made of aluminium

Belt-driven centrifugal roof-mounted extractor fans with vertical air outlet made of aluminium, for extraction in industrial hoods and kitchens and harmful atmospheres.

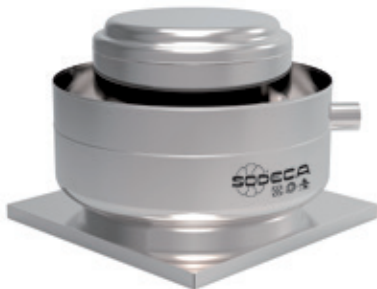

### Fan:

- Galvanised sheet steel support base.
- Impeller with reaction blades, made of sheet steel.
- Cylindrical casing and cover plate made of aluminium.
- Top cover plate easy to open for inspection and maintenance.
- Transmission unit supported by shock absorbers to prevent noise and vibrations.

### Motor:

- IE3 efficiency motors for powers equal to or greater than 0.75kW except single-phase, 2-speed and 8-pole.

- Class F motors with ball bearings and IP55 protection.
- Multi voltage motor, special design valid for 220/380V 60Hz, 254/440V 60Hz, 265/460V 60Hz, 277/480V 60Hz.
- Maximum temperature of air to be carried: -20 °C + 120 °C

### Finish:

- Anti-corrosive finished sheet aluminium with a satin finish and parts in galvanised steel.

### Order code

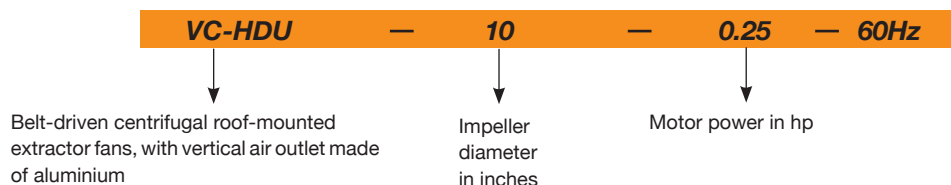

**60Hz**

### Technical characteristics

Model	Speed (r/min)	Maximum current current (A)		Installed power (kW)	Maximum flow rate (m³/h)	Sound pressure level dB(A)	Approx. weight (kg)
		220-277V	380-480V				
VC-HDU-10-0.25	1580	1.23	0.71	0.18	2690	36	28
VC-HDU-10-0.33	1760	1.52	0.88	0.25	3000	39	28
VC-HDU-12-0.25	1200	1.23	0.71	0.18	2850	38	33
VC-HDU-12-0.33	1340	1.52	0.88	0.25	3180	40	33
VC-HDU-12-0.5	1530	2.02	1.17	0.37	3630	43	34
VC-HDU-15-0.25	840	1.23	0.71	0.18	3580	36	34
VC-HDU-15-0.33	935	1.52	0.88	0.25	3990	38	34
VC-HDU-15-0.5	1065	2.02	1.17	0.37	4550	41	35
VC-HDU-15-0.75	1220	2.87	1.66	0.55	5190	44	37
VC-HDU-15-1	1350	2.82	1.62	0.75	5750	46	42
VC-HDU-18-0.25	665	1.23	0.71	0.18	4470	31	42
VC-HDU-18-0.33	740	1.52	0.88	0.25	4980	33	42
VC-HDU-18-0.5	845	2.02	1.17	0.37	5680	36	43
VC-HDU-18-0.75	965	2.87	1.66	0.55	6490	39	45
VC-HDU-18-1	1070	2.82	1.62	0.75	7190	41	50
VC-HDU-18-1.5	1215	4.07	2.34	1.1	8170	44	55



### Technical characteristics

Model	Speed (r/min)	Maximum current current (A)		Installed power (kW)	Maximum flow rate (m <sup>3</sup> /h)	Sound pressure level dB(A)	Approx. weight (kg)
		220-277V	380-480V				
VC-HDU-18-2	1350	5.48	3.15	1.5	9080	46	58
VC-HDU-20-0.33	640	1.52	0.88	0.25	5900	33	44
VC-HDU-20-0.5	735	2.02	1.17	0.37	6730	36	45
VC-HDU-20-0.75	835	2.87	1.66	0.55	7670	39	47
VC-HDU-20-1	925	2.82	1.62	0.75	8510	41	52
VC-HDU-20-1.5	1050	4.07	2.34	1.1	9670	44	57
VC-HDU-20-2	1170	5.48	3.15	1.5	10740	46	60
VC-HDU-22-0.33	510	1.52	0.88	0.25	6950	32	83
VC-HDU-22-0.5	580	2.02	1.17	0.37	7920	35	84
VC-HDU-22-0.75	660	2.87	1.66	0.55	9020	38	86
VC-HDU-22-1	735	2.82	1.62	0.75	10030	40	91
VC-HDU-22-1.5	835	4.07	2.34	1.1	11400	43	96
VC-HDU-22-2	930	5.48	3.15	1.5	12660	45	99
VC-HDU-24-0.33	495	1.52	0.88	0.25	8510	34	86
VC-HDU-24-0.5	565	2.02	1.17	0.37	9700	37	87
VC-HDU-24-0.75	645	2.87	1.66	0.55	11070	40	89
VC-HDU-24-1	715	2.82	1.62	0.75	12270	42	94
VC-HDU-24-1.5	810	4.07	2.34	1.1	13950	45	99
VC-HDU-24-2	900	5.48	3.15	1.5	15490	47	102

\*Sound pressure level measured at a distance of 6 metros and average flow rate (1/2 Qmax.)

### Dimensions mm

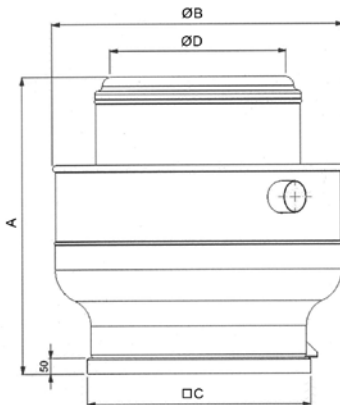

Model	A	ØB	C	ØD
VC-HDU-10	640	660	530	400
VC-HDU-12	750	750	610	450
VC-HDU-15	750	750	610	450
VC-HDU-18	944	928	710	560
VC-HDU-20	944	928	710	560
VC-HDU-22	1050	1190	920	720
VC-HDU-24	1050	1190	920	720

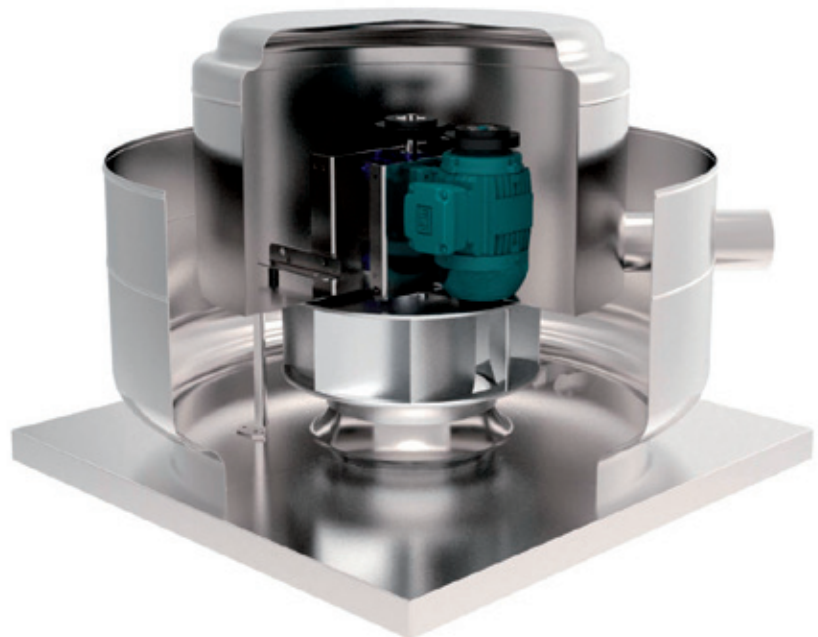

**Characteristic curves**

Q= Flow rate in m<sup>3</sup>/h, m<sup>3</sup>/s and cfm

Pe= Static pressure in mm H<sub>2</sub>O, Pa and inwg.

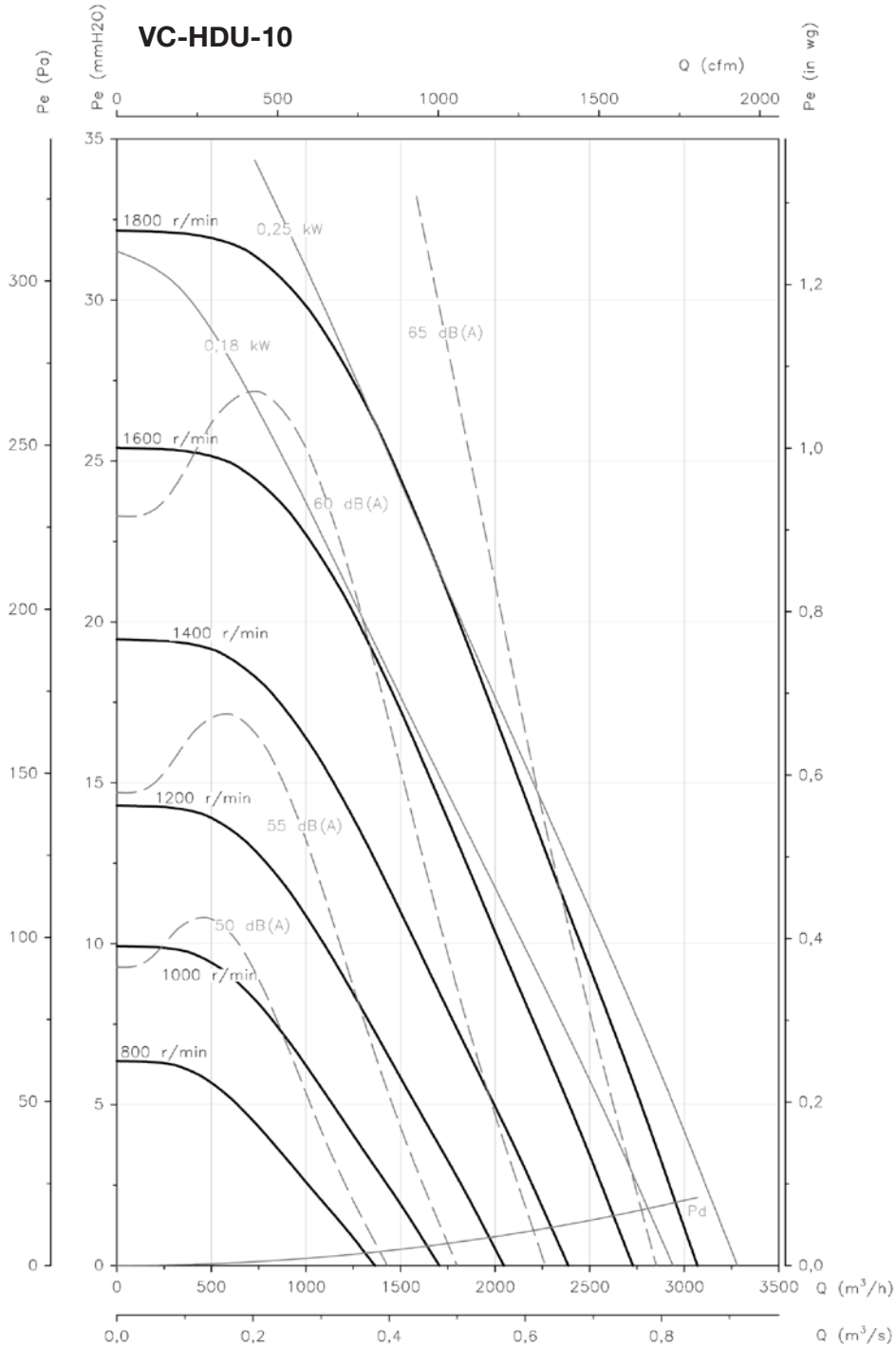

**Characteristic curves**

Q= Flow rate in m<sup>3</sup>/h, m<sup>3</sup>/s and cfm

Pe= Static pressure in mm H<sub>2</sub>O, Pa and inwg.

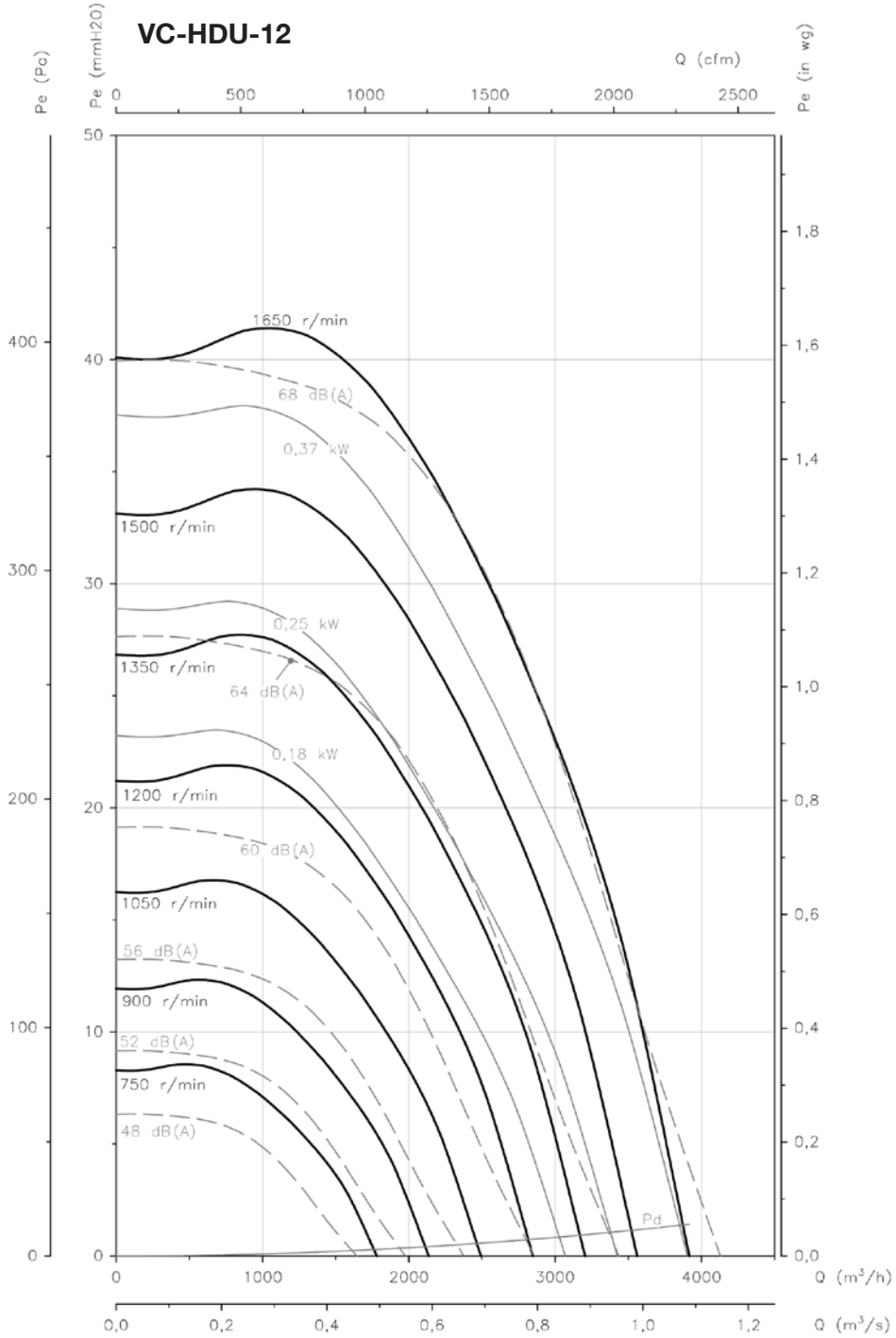

**Characteristic curves**

Q= Flow rate in m<sup>3</sup>/h, m<sup>3</sup>/s and cfm

Pe= Static pressure in mm H<sub>2</sub>O, Pa and inwg.

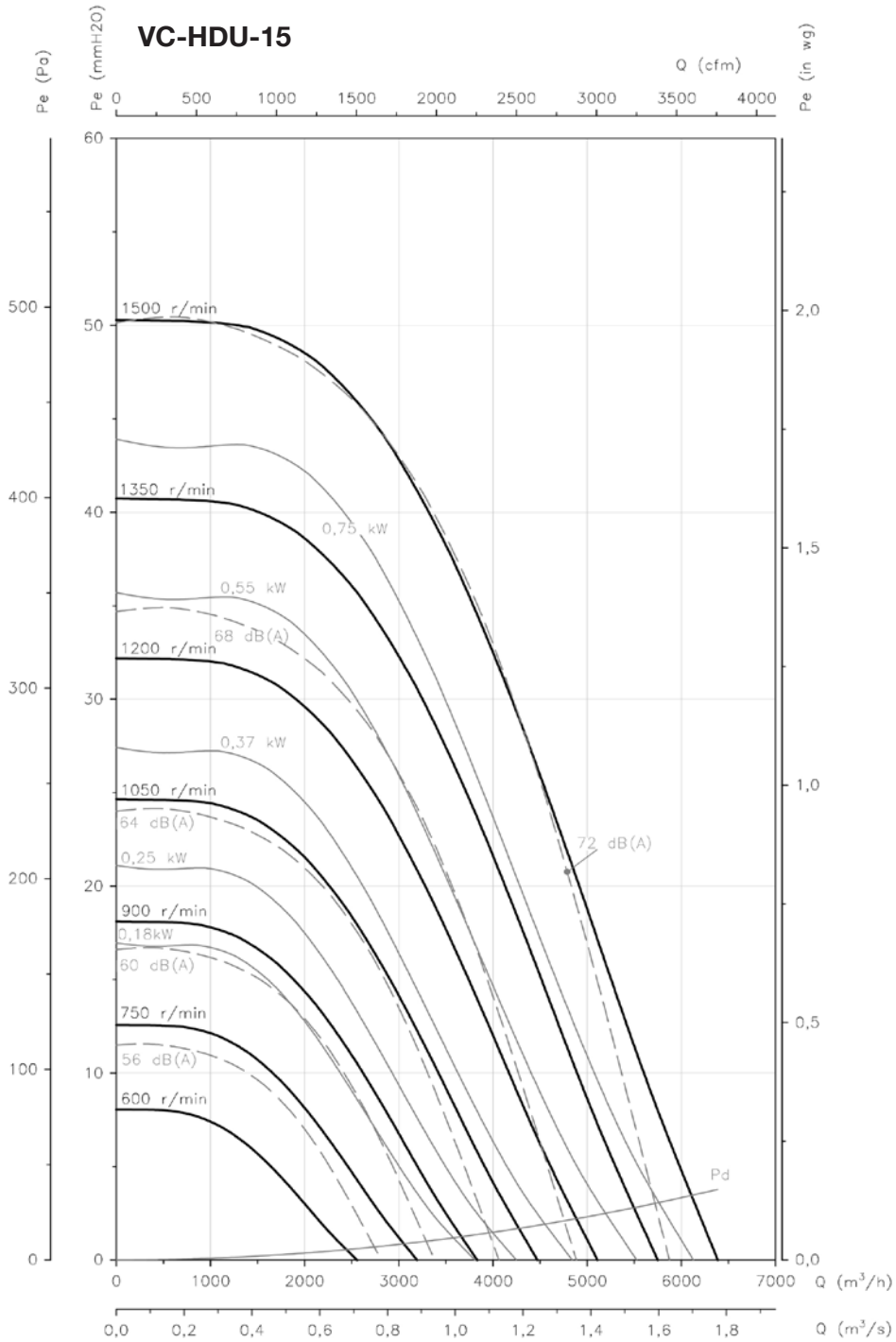

**Characteristic curves**

Q= Flow rate in m<sup>3</sup>/h, m<sup>3</sup>/s and cfm

Pe= Static pressure in mm H<sub>2</sub>O, Pa and inwg.

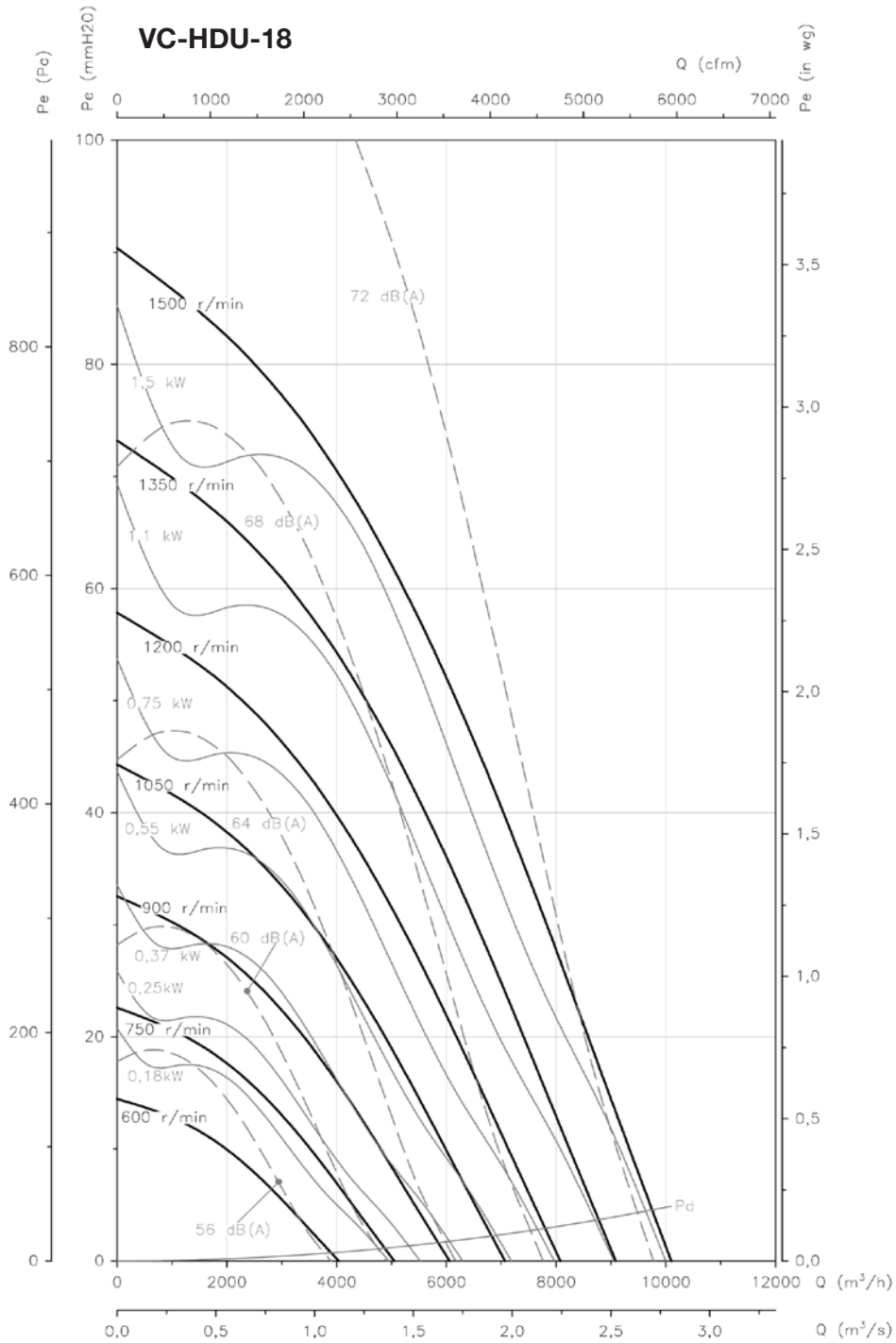

**Characteristic curves**

Q= Flow rate in m<sup>3</sup>/h, m<sup>3</sup>/s and cfm

Pe= Static pressure in mm H<sub>2</sub>O, Pa and inwg.

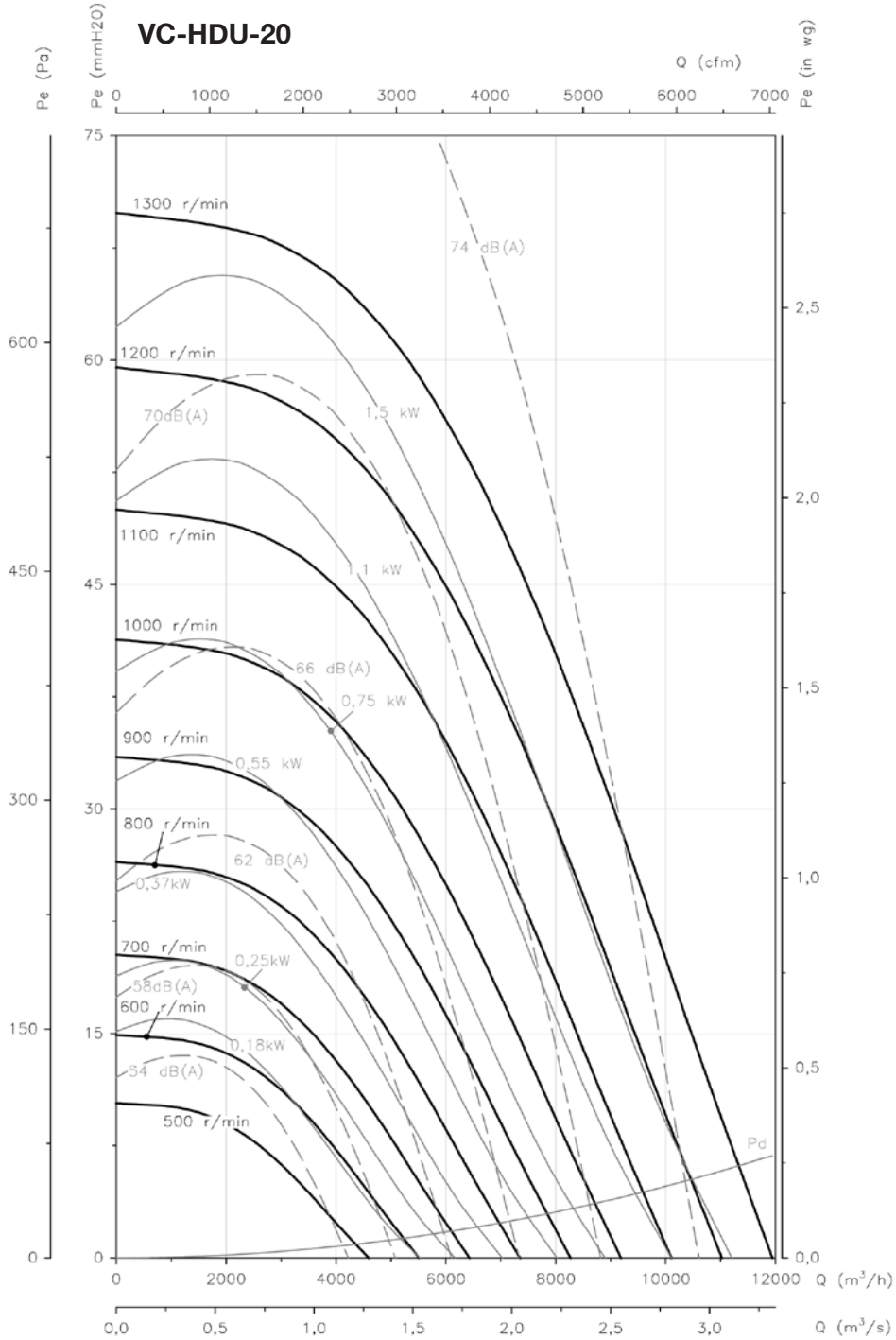

**Characteristic curves**

Q= Flow rate in m<sup>3</sup>/h, m<sup>3</sup>/s and cfm

Pe= Static pressure in mm H<sub>2</sub>O, Pa and inwg.

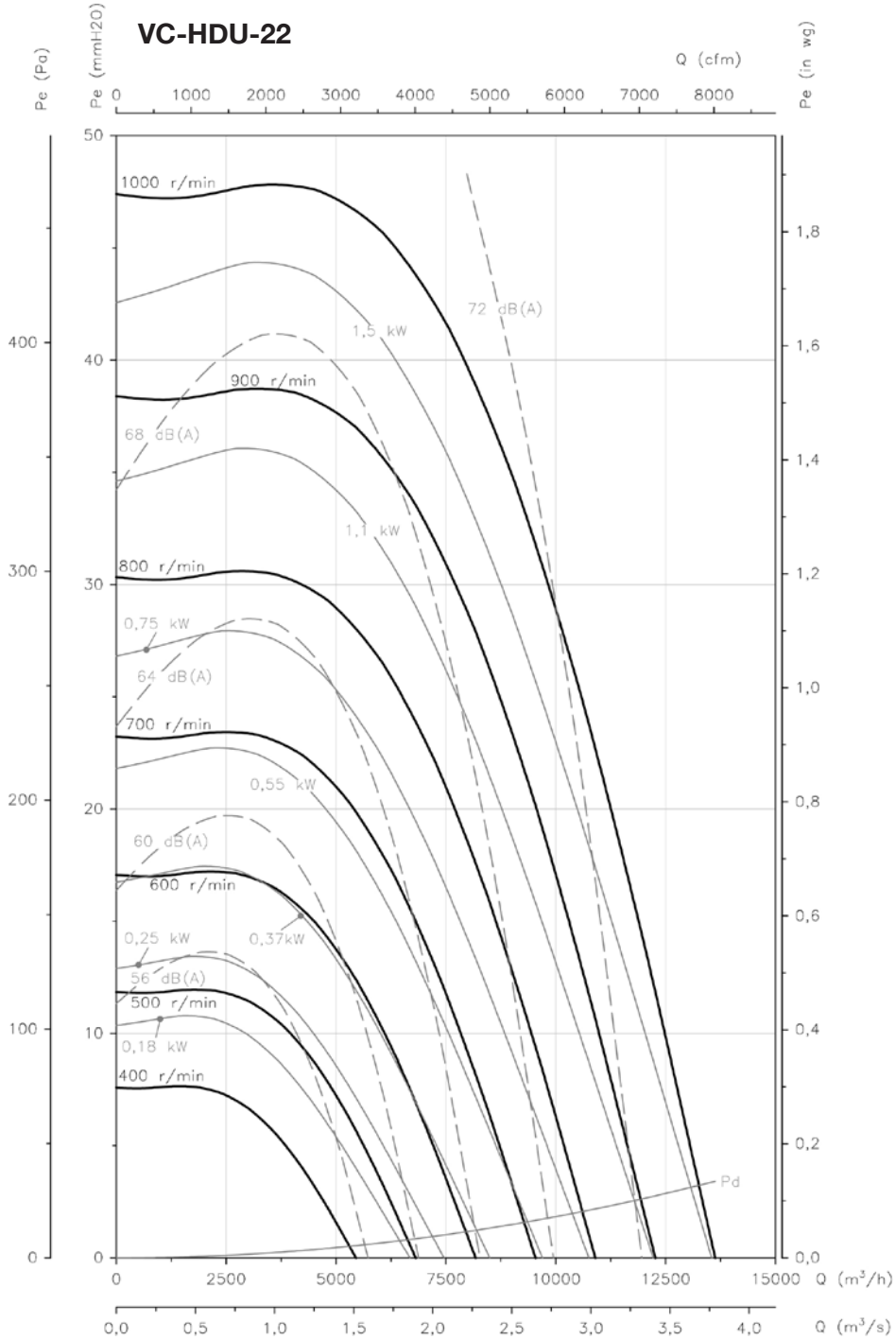

**Characteristic curves**

Q= Flow rate in m<sup>3</sup>/h, m<sup>3</sup>/s and cfm

Pe= Static pressure in mm H<sub>2</sub>O, Pa and inwg.

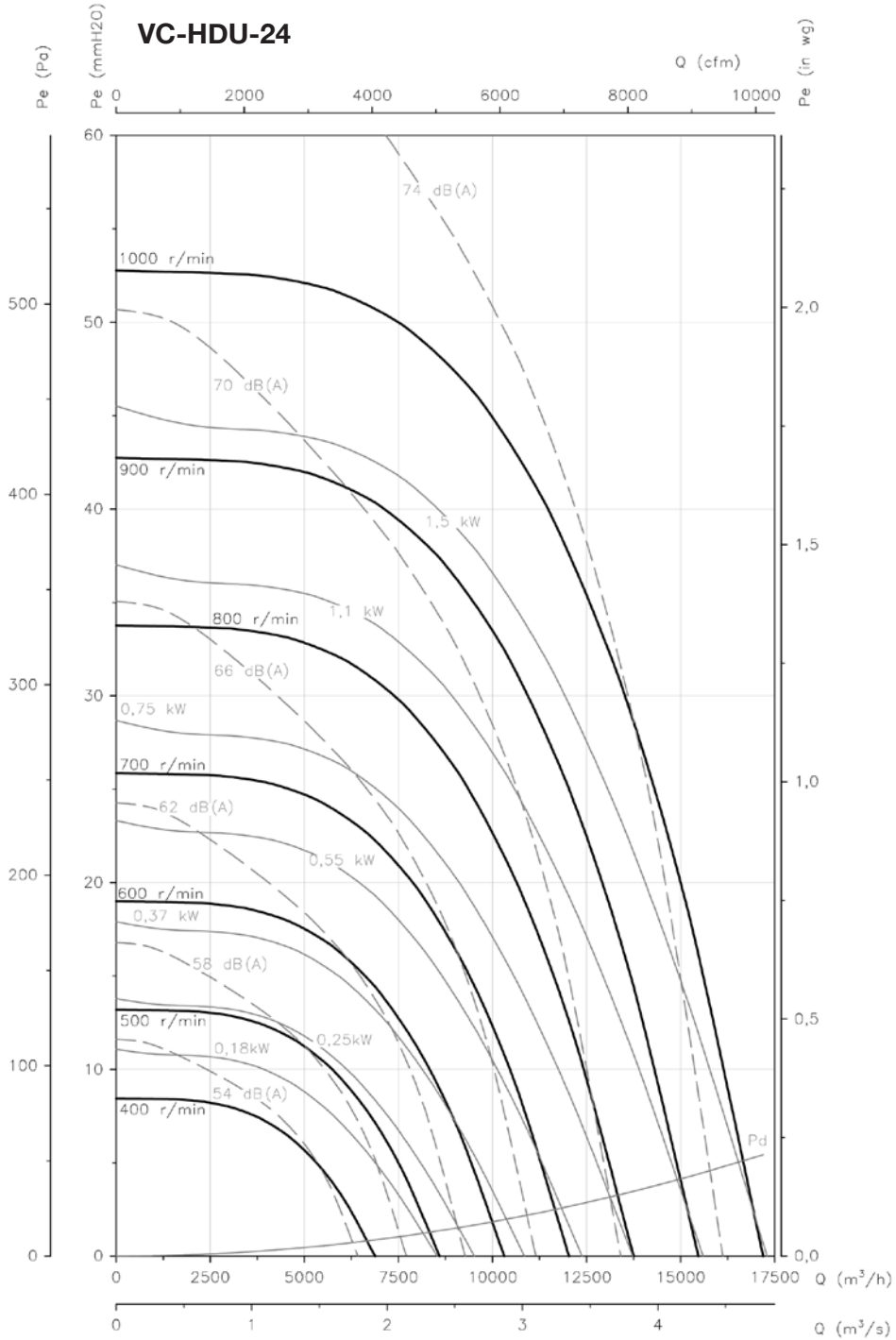



# CXT

## Roof-mounted, belt-driven centrifugal fans with a vertical or horizontal air impulsion design

Roof-mounted, centrifugal fans with a vertical or a horizontal air impulsion design, belt-driven double impulsion and washable filters.



Standard supply  
Vertical impulsion

### Fan:

- Galvanised sheet steel support base.
- Aluminium rain cap and deflectors.
- Aluminium profiles structure and lateral covers in pre-lacquered sheet steel.
- Activated by a belt and pulley transmission system.
- Vertical or horizontal air outlet, adjustable by the customer depending on installation needs.
- Cable gland for cable entry.
- Forward-curved impeller made of galvanised sheet steel.
- Metal air intake filters that are easy to wash.

### Motor:

- IE3 efficiency motors for powers equal to or greater than 0.75 kW except single-phase, 2-speed and 8-pole.
- Class F motors with ball bearings and IP55 protection.
- 220-254V / 380-440V, 60Hz. three-phase power supply.
- Maximum temperature of air to be carried: -20 °C. +60 °C.

### Finish:

- Anti-corrosive finished pre-lacquered galvanised sheet steel and aluminium.

### On request:

- With a horizontal impulsion.



Horizontal  
impulsion nozzle,

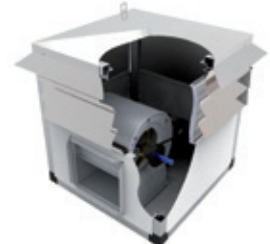

### Order code

<b>CXT</b>	—	<b>9/9</b>	—	<b>3</b>	—	<b>V</b>	—	<b>60Hz</b>
↓		↓		↓		↓		
CXT: Roof-mounted centrifugal fans with a vertical or horizontal air outlet design		Impeller size in inches		Motor power in hp		V: Vertical impulsion H: Horizontal impulsion		

### Technical characteristics

**60Hz**

Model	Speed (r/min)	Maximum current current (A)		Installed power (kW)	Maximum flow rate (m³/h)	Sound pressure level* dB(A)	Approx. weight (kg)
		220-254V	380-440V				
CXT-9/9-0.25	650	1.23	0.71	0.18	2635	45	111
CXT-9/9-0.33	725	1.52	0.88	0.25	2940	48	111
CXT-9/9-0.5	825	2.02	1.17	0.37	3350	50	112
CXT-9/9-0.75	940	2.87	1.66	0.55	3820	53	114
CXT-9/9-1 IE3	1045	2.82	1.62	0.75	4240	56	119
CXT-9/9-1.5 IE3	1185	4.07	2.34	1.10	4815	58	124
CXT-10/10-0.5	650	2.02	1.17	0.37	4065	50	121
CXT-10/10-0.75	740	2.87	1.66	0.55	4640	53	123
CXT-10/10-1 IE3	820	2.82	1.62	0.75	5145	55	128
CXT-10/10-1.5 IE3	930	4.07	2.34	1.10	5845	58	133
CXT-10/10-2 IE3	1035	5.48	3.15	1.50	6495	60	136
CXT-12/12-0.5	535	2.02	1.17	0.37	4885	40	140
CXT-12/12-0.75	610	2.87	1.66	0.55	5580	43	141
CXT-12/12-1 IE3	680	2.82	1.62	0.75	6185	45	146
CXT-12/12-1.5 IE3	770	4.07	2.34	1.10	7030	48	151
CXT-12/12-2 IE3	855	5.48	3.15	1.50	7805	50	155

### Technical characteristics

Model	Speed (r/min)	Maximum current current (A)		Installed power (kW)	Maximum flow rate (m <sup>3</sup> /h)	Sound pressure level* dB(A)	Approx. weight (kg)
		220-254V	380-440V				
CXT-12/12-3 IE3	975	7.93	4.56	2.20	8890	53	163
CXT-15/15-0.75	450	2.87	1.66	0.55	7195	44	159
CXT-15/15-1 IE3	495	2.82	1.62	0.75	7910	46	164
CXT-15/15-1.5 IE3	570	4.07	2.34	1.10	9075	49	169
CXT-15/15-2 IE3	630	5.48	3.15	1.50	10075	51	173
CXT-15/15-3 IE3	720	7.93	4.56	2.20	11515	54	181
CXT-18/18-1.5 IE3	455	4.07	2.34	1.10	11390	50	246
CXT-18/18-2 IE3	505	5.48	3.15	1.50	12650	52	249
CXT-18/18-3 IE3	575	7.93	4.56	2.20	14410	55	258
CXT-18/18-4 IE3	640	10.70	6.15	3.00	16020	58	264
CXT-18/18-5.5 IE3	705	13.90	8.00	4.00	17695	60	270

\*Sound pressure level measured at a distance of 6 metros and average flow rate (1/2 Qmax.)

### Dimensions mm

Standard supply  
vertical impulsion

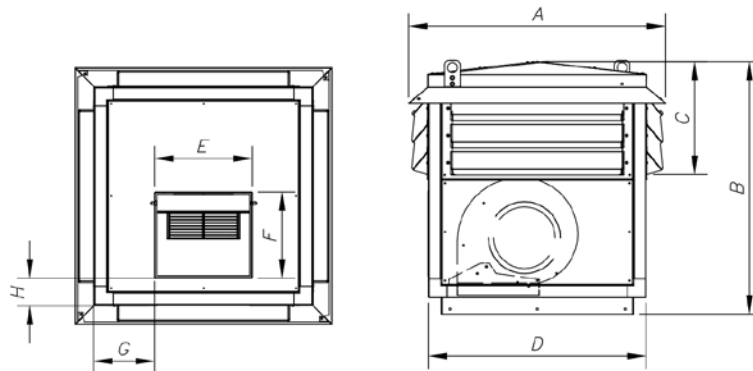

Horizontal impulsion  
on request

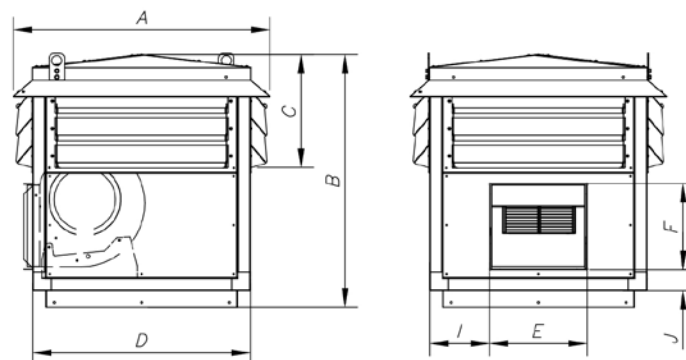

Model	A	B	C	D	E	F	G	H	I	J
CXT-9/9	824	811	362	700	314	277	196	88	192	67
CXT-10/10	925	855	362	802	314	305	230	125	226	67
CXT-12/12	1027	995	451	903	348	358	250	136	245	67
CXT-15/15	1027	1060	451	902	411	420	211	74	207	67
CXT-18/18	1129	1400	718	1005	487	496	220	46	216	67

**Characteristic curves**

Flow rate in m<sup>3</sup>/h.      Static pressure in Pa.      Electrical power in W.      Sound power in dBA.

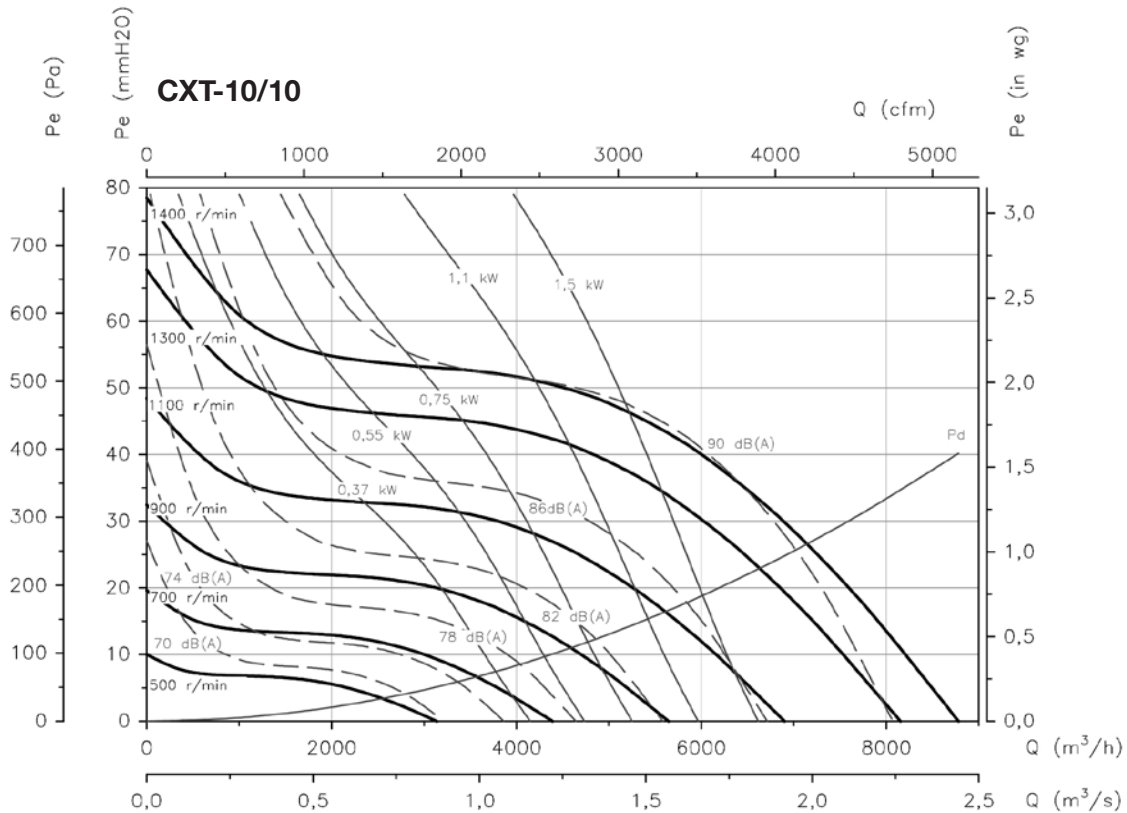
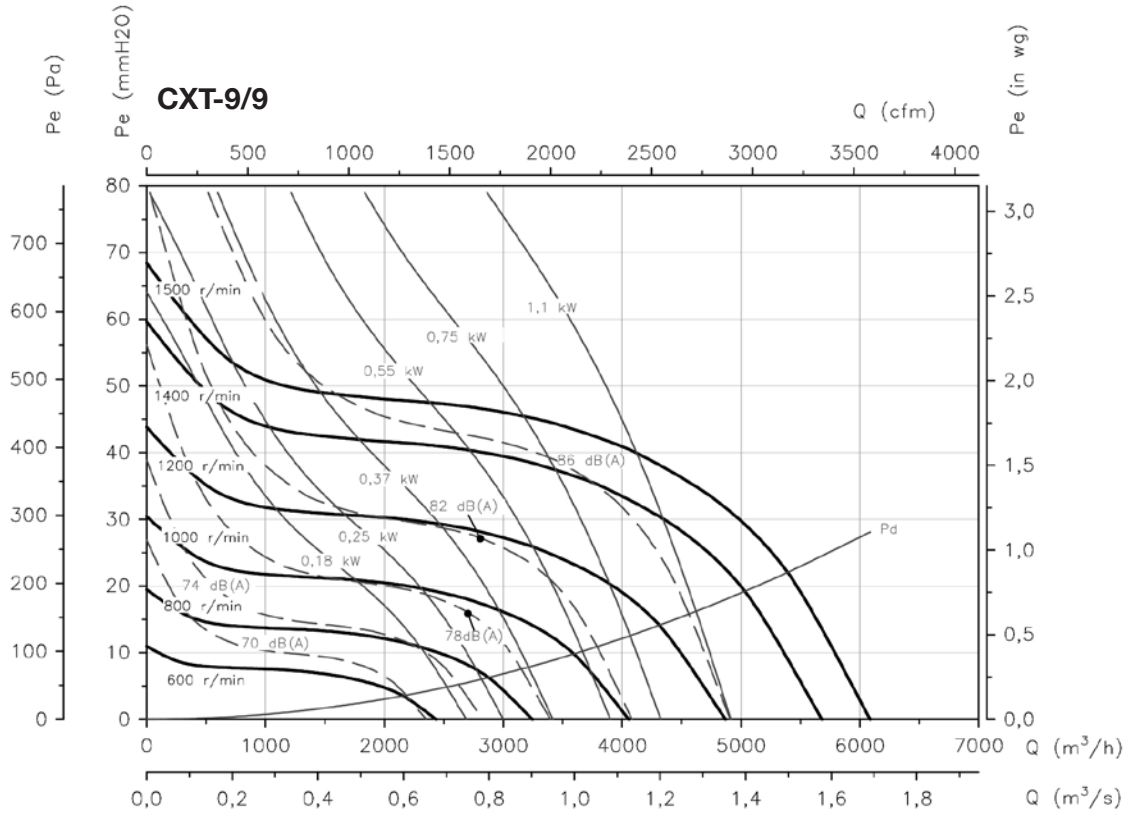

**Characteristic curves**

Flow rate in m<sup>3</sup>/h.    Static pressure in Pa.    Electrical power in W.    Sound power in dBA.

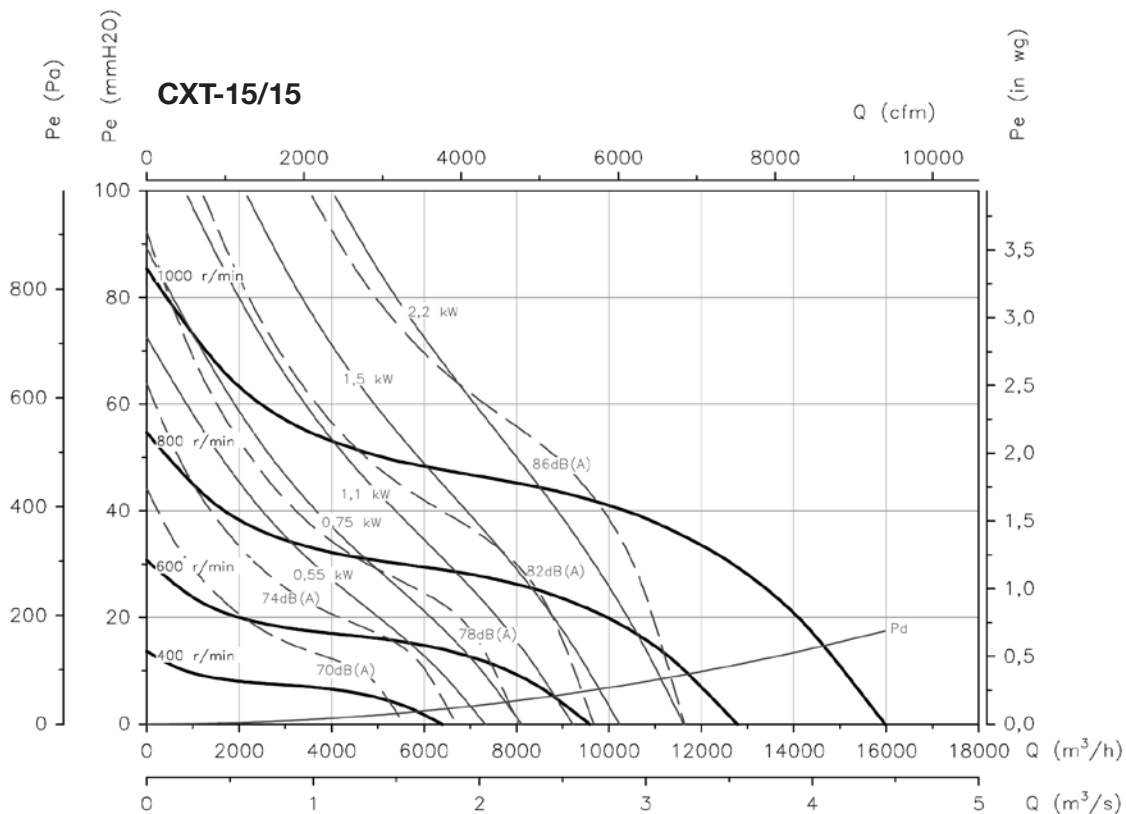
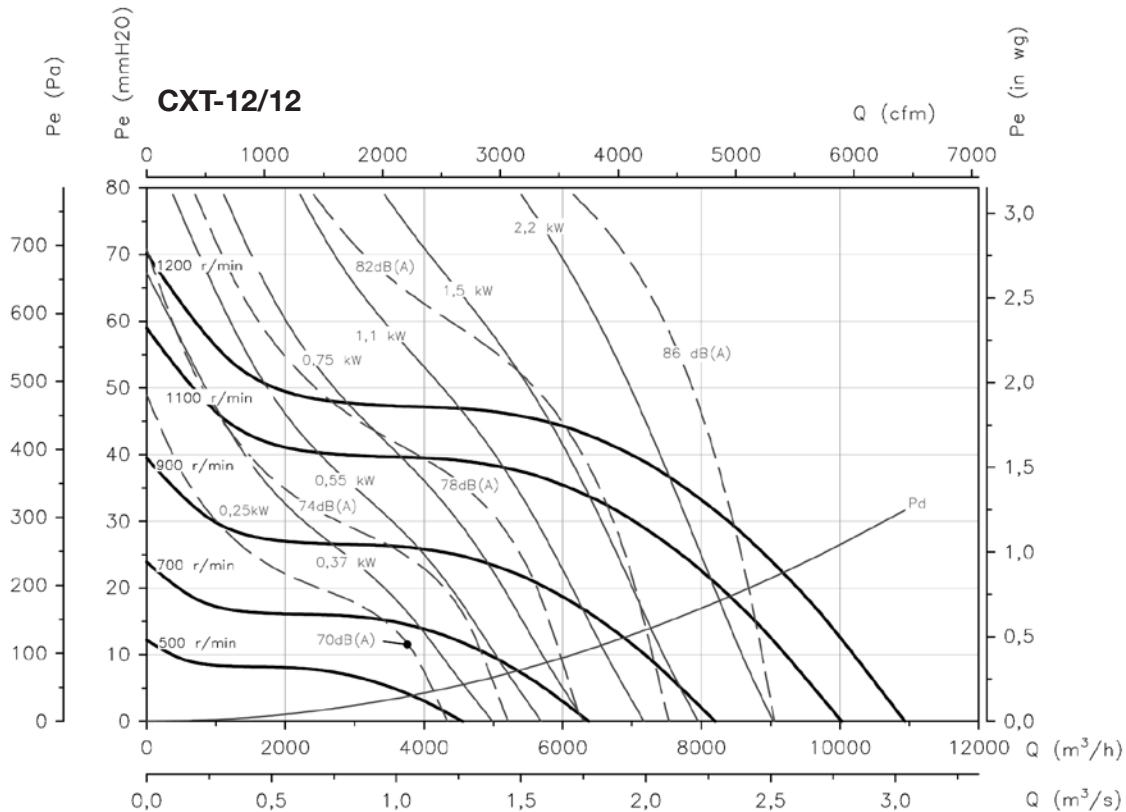

**Characteristic curves**

Flow rate in m<sup>3</sup>/h.    Static pressure in Pa.    Electrical power in W.    Sound power in dBA.

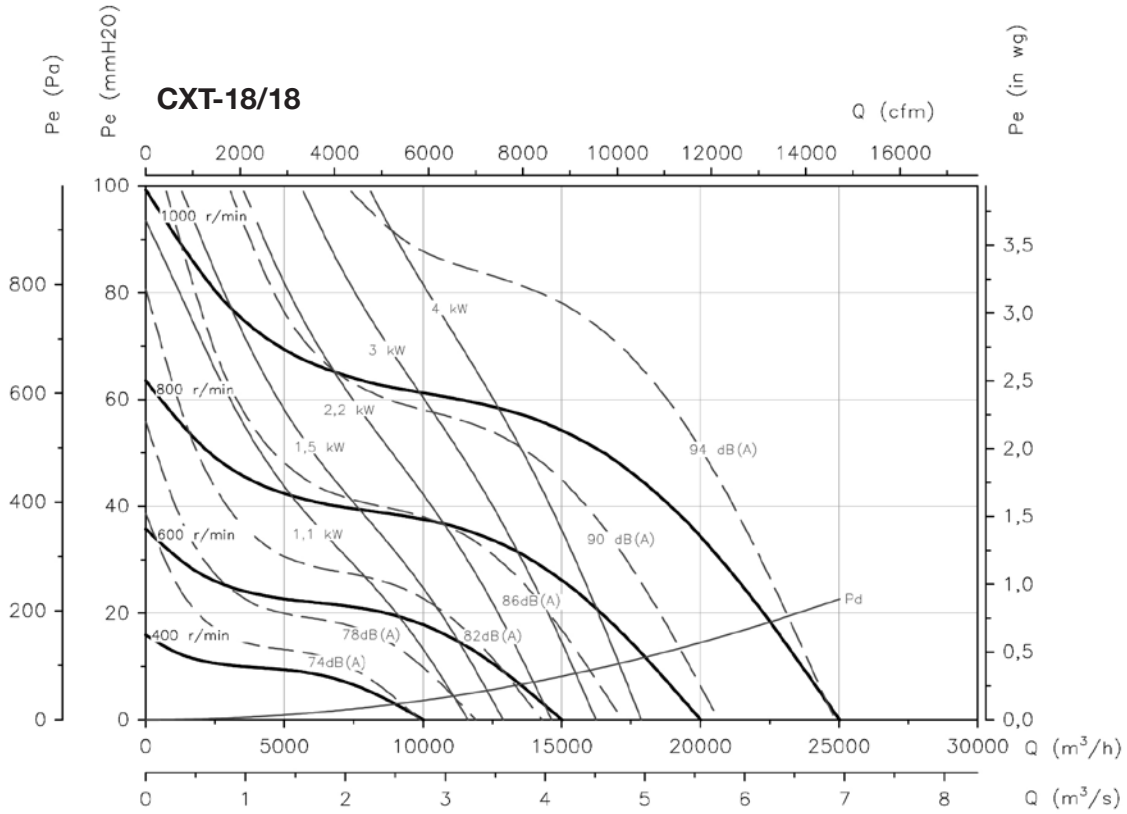

**Accessories**



INT

C2V

RM

VSD

AET

VIS

# RFH RFV



## 400 °C/2h centrifugal roof-mounted extractor fans with vertical or horizontal air outlet

RFH: 400 °C/2h centrifugal roof-mounted extractor fans, with horizontal air outlet and aluminium rain cap.

RFV: 400 °C/2h centrifugal roof-mounted extractor fans, with vertical air outlet and aluminium rain cap.



### Fan:

- Galvanised sheet steel support base.
- Impeller with reaction blades, made of galvanised sheet steel.
- Bird control grille.
- Aluminium rain cap.
- Approved in accordance with standard EN 12101-3:2002/AC:2006.

- Multi voltage motor, special design valid for 220/380V 60Hz, 254/440V 60Hz, 265/460V 60Hz, 277/480V 60Hz.
- Maximum temperature of air to be carried: -25 °C +120 °C.

### Finish:

- Anti-corrosive finished galvanised sheet steel and aluminium.

### Motor:

- IE3 efficiency motors for powers equal to or greater than 0.75kW except single-phase, 2-speed and 8-pole.
- Class F motors with ball bearings and IP55 protection.

### On request:

- Special windings for different voltages.
- ATEX-certified Category 3.

### Order code

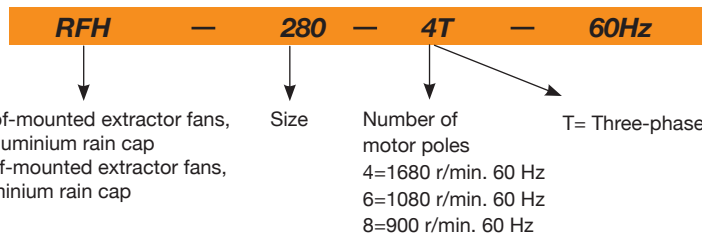

### Technical characteristics

60Hz

Model	Speed (r/min)	Maximum current (A)		Installed power (kW)	Maximum flow rate (m <sup>3</sup> /h)	Sound pressure level dB(A)		Approx. weight (kg)
		220-277V	380-480V			Intake	Discharge	
RFH RFV 280-4T	1620	1.66	0.96	0.25	1450	38.85	45.15	25
RFH RFV 280-4M	1656	0.65		0.25	1450	38.85	45.15	25
RFH RFV 315-4T	1620	1.66	0.96	0.25	2100	43.05	49.35	25
RFH RFV 315-4M	1656	0.95		0.25	2100	43.05	49.35	25
RFH RFV 315-6T	1080	1.51	0.87	0.25	1400	31.50	37.80	25
RFH RFV 315-6M	1068	0.50		0.25	1400	31.50	37.80	25
RFH RFV 355-4T	1620	1.66	0.96	0.25	3100	47.25	52.50	32
RFH RFV 355-4M	1656	1.35		0.25	3100	47.25	52.50	32
RFH RFV 355-6T	1080	1.51	0.87	0.25	2000	34.65	42.00	33
RFH RFV 355-6M	1068	0.65		0.25	2000	34.65	42.00	33
RFH RFV 400-4T	1656	2.92	1.69	0.55	4950	50.40	56.70	35
RFH RFV 400-4M	1656	3.30		0.55	4950	50.40	56.70	35

### Technical characteristics

Model			Speed (r/min)	Maximum current (A)		Installed power (kW)	Maximum flow rate (m <sup>3</sup> /h)	Sound pressure level dB(A)		Approx. weight (kg)
				220-277V	380-480V			Intake	Discharge	
RFH	RFV	400-6T	1080	2.24	1.30	0.37	3200	38.85	45.15	35
RFH	RFV	400-6M	1092	0.95		0.37	3200	38.85	45.15	35
RFH	RFV	450-4T	1692	3.10	1.79	0.75	7000	57.75	64.05	52
RFH	RFV	450-4M	1656	4.40		0.75	7000	57.75	64.05	52
RFH	RFV	450-6T	1080	2.24	1.30	0.37	4500	46.20	52.50	51
RFH	RFV	450-6M	1092	1.80		0.37	4500	46.20	52.50	51
RFH	RFV	500-4T	1716	5.96	3.44	1.50	10200	61.95	67.20	60
RFH	RFV	500-6T	1080	2.24	1.30	0.37	6900	49.35	56.70	53
RFH	RFV	500-6M	1092	2.00		0.37	6900	49.35	56.70	53
RFH	RFV	630-6T	1134	4.88	2.82	1.10	12000	53.55	59.85	95
RFH	RFV	630-8T	834	3.53	2.04	0.55	8900	46.20	52.50	95
RFH	RFV	710-6T	1146	9.30	5.30	2.20	17300	56.70	64.05	118
RFH	RFV	710-8T	846	5.63	3.25	1.10	12900	48.30	55.65	102
RFH	RFV	800-6T	1152	16.50	9.46	4.00	24700	60.90	67.20	160
RFH	RFV	800-8T	846	7.10	4.10	1.50	18400	52.50	59.85	142

### Acoustic characteristics

The indicated values are determined by measuring the pressure and sound power levels in dB(A) obtained in a free field at a distance of 6 m.

#### Sound power spectrum Lw(A) in dB(A) per Hz frequency band

Values taken during intake with 2/3 maximum flow rate (2/3Qmax).

Model	63	125	250	500	1000	2000	4000	8000
280-4	35	41	52	55	56	52	50	44
315-4	42	51	56	56	60	59	52	46
315-6	31	40	45	45	49	48	41	35
355-4	46	55	60	60	64	63	56	50
355-6	34	43	48	48	52	51	44	38
400-4	50	56	62	62	65	68	59	53
400-6	39	45	51	51	54	57	48	42
450-4	57	63	69	69	72	75	66	60
450-6	46	52	58	58	61	64	55	49
500-4	62	69	74	74	78	77	70	65
500-6	50	57	62	62	66	65	58	53
630-6	54	60	65	66	70	69	62	55
630-8	47	53	58	59	63	62	55	48
710-6	57	63	68	69	73	72	65	58
710-8	49	55	60	61	65	64	57	50
800-6	61	67	72	73	77	76	69	62
800-8	53	59	64	65	69	68	61	54

Values taken during discharge with 2/3 maximum flow rate (2/3Qmax).

Model	63	125	250	500	1000	2000	4000	8000
280-4	39	44	58	60	61	61	56	51
315-4	41	50	60	64	67	64	57	51
315-6	30	39	49	53	56	53	46	40
355-4	44	53	63	67	70	67	60	54
355-6	34	43	53	57	60	57	50	44
400-4	49	61	69	71	72	72	64	56
400-6	38	50	58	60	61	61	53	45
450-4	56	68	76	78	79	79	71	63
450-6	45	57	65	67	68	68	60	52
500-4	60	72	80	82	83	80	73	65
500-6	50	62	70	72	73	70	63	55
630-6	50	64	72	76	75	72	66	60
630-8	43	57	65	69	68	65	59	53
710-6	54	68	76	80	79	76	70	64
710-8	46	60	68	72	71	68	62	56
800-6	57	71	79	83	72	79	73	67
800-8	50	64	72	76	72	72	66	60

To obtain the Lwa noise power spectra in dB(A) in intake at maximum flow rate (Qmax), add the values set out in the following chart to the LpA sound pressure level given in the characteristic curves:

Frequency band (Hz)							
63	125	250	500	1000	2000	4000	8000
2	9	15	15	18	18	11	5

### Dimensions mm

#### RFH

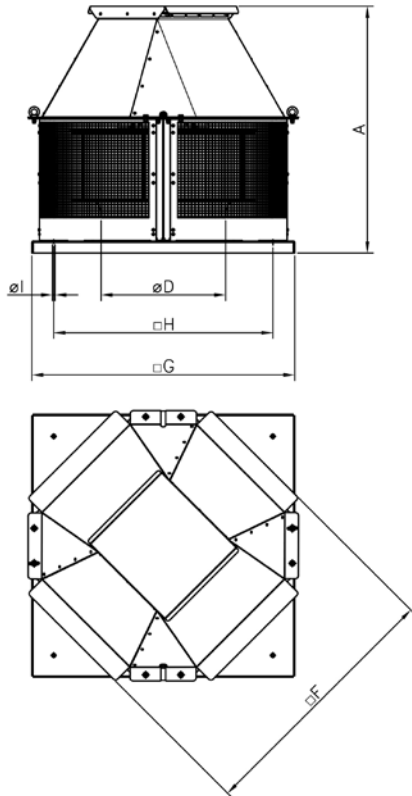

Model	A	ØD*	F	G	H	ØI
RFH-280	515	250	460	450	360	12
RFH-315	540	250	460	450	360	12
RFH-355	610	355	565	560	450	12
RFH-400	665	355	565	560	450	12
RFH-450	740	500	735	710	590	12
RFH-500	755	500	735	710	590	12
RFH-630	845	630	890	900	750	14
RFH-710	995	710	1110	1100	900	14
RFH-800	1065	710	1110	1100	900	14

(\*) Recommended pipe nominal diameter

#### RFV

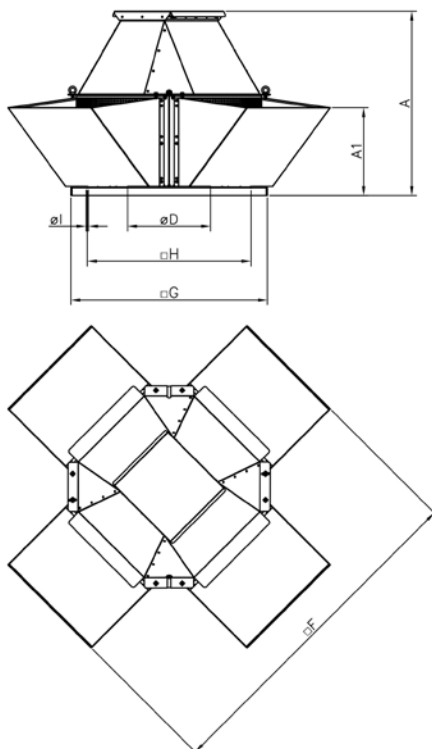

Model	A	A1	ØD*	F	G	H	ØI
RFV-280	515	235	250	800	450	360	12
RFV-315	540	235	250	800	450	360	12
RFV-355	610	305	355	1045	560	450	12
RFV-400	665	305	355	1045	560	450	12
RFV-450	740	340	500	1255	710	590	12
RFV-500	755	340	500	1255	710	590	12
RFV-630	845	400	630	1550	900	750	14
RFV-710	995	455	710	1875	1100	900	14
RFV-800	1065	455	710	1875	1100	900	14

(\*) Recommended pipe nominal diameter



**Characteristic curves**

Q= Flow rate in m<sup>3</sup>/h, m<sup>3</sup>/s and cfm.

Pe= Static pressure in mm H<sub>2</sub>O, Pa and inwg.

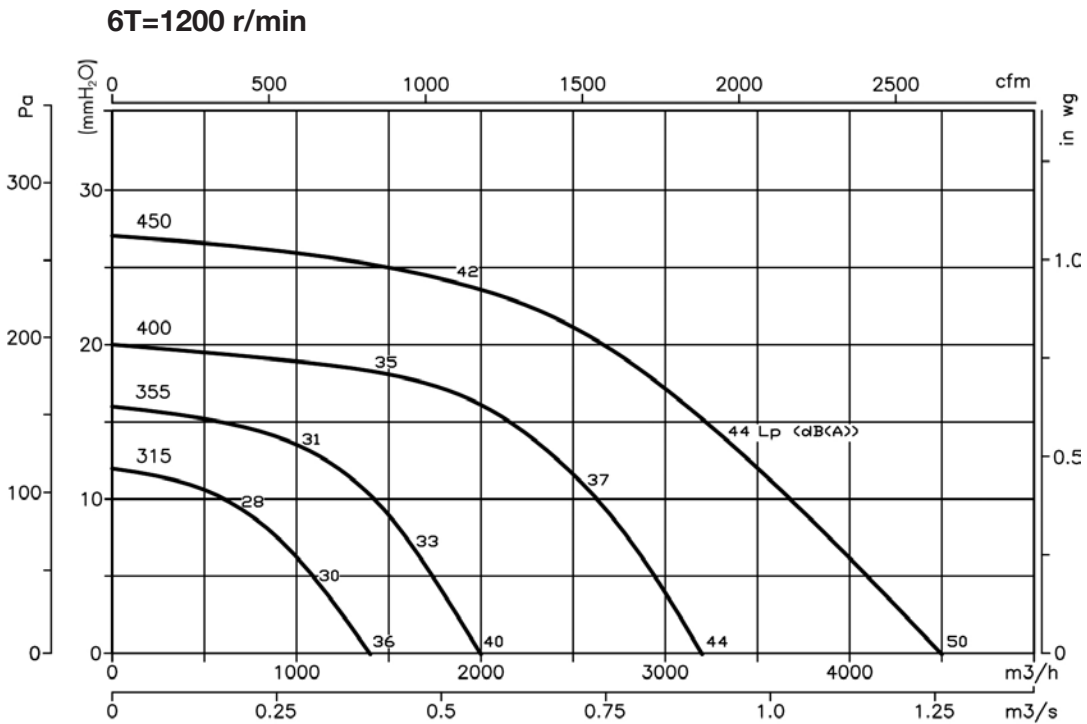
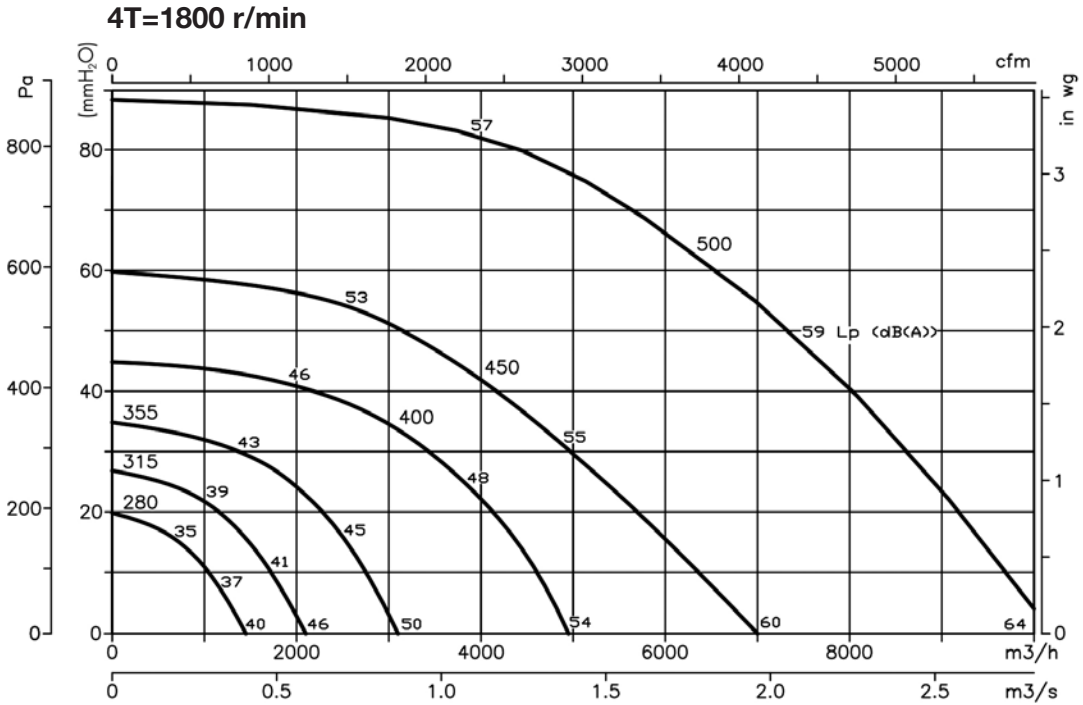

**Characteristic curves**

Q= Flow rate in m<sup>3</sup>/h, m<sup>3</sup>/s and cfm.

Pe= Static pressure in mm H<sub>2</sub>O, Pa and inwg.

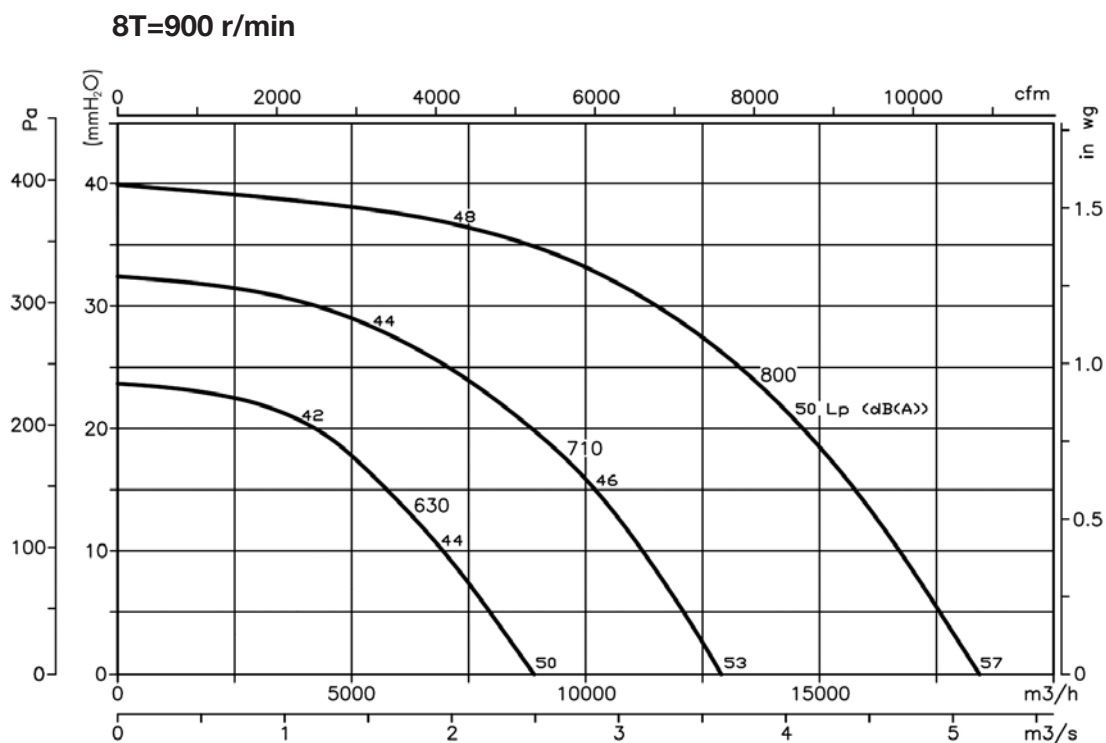
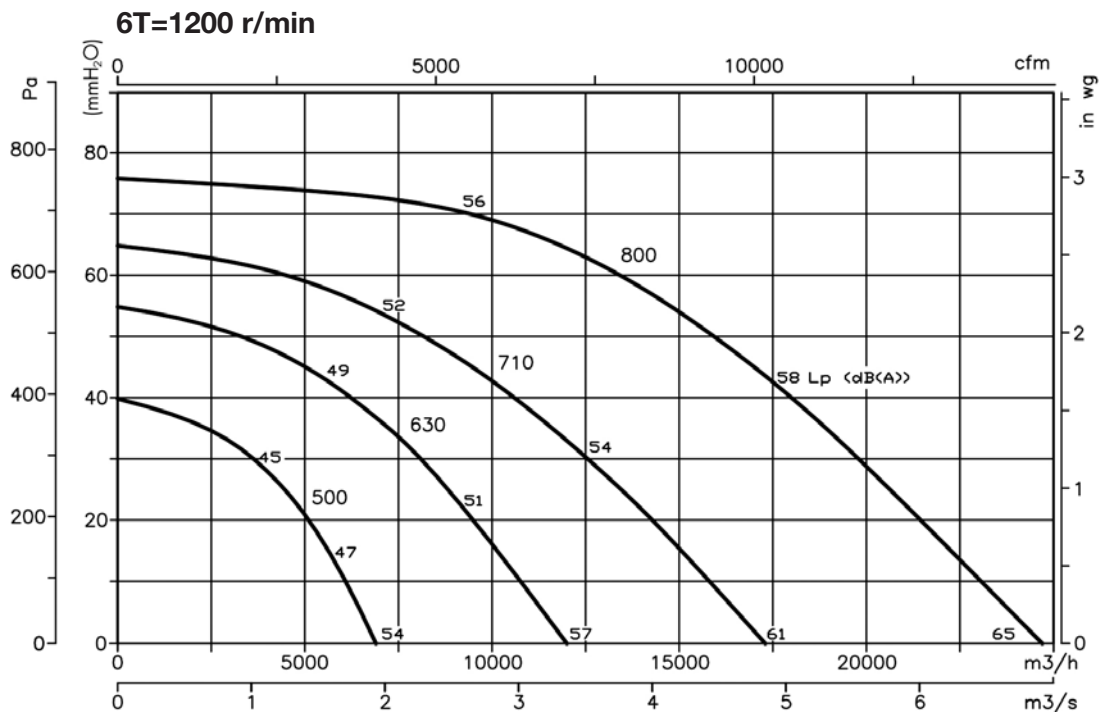

# CRF



## Roof-mounted centrifugal extractor fans, with low noise level

Centrifugal roof-mounted extractor fans with low noise level and external rotor motor.

### Fan:

- Made of galvanised sheet steel.
- Impeller with reaction blades built of aluminium sheet metal except for models 225 and 250, which are made of galvanised sheet steel.
- Bird control grille.
- Folding body for ease of inspection and maintenance.

### Motor:

- Class F motors, external rotor and IP54 protection.
- Single-phase 230V-50/60Hz, except 450 and 500 230V 60Hz.
- Multi voltage motor, special design valid for 220/380V 60Hz, 254/440V 60Hz, 265/460V 60Hz, 277/480V 60Hz
- Maximum temperature of air to be carried: -25°C + 50 °C.

### Finish:

- Anti-corrosive finished galvanised sheet steel.

### On request:

- The variable speed drive (VSD) is supplied on request.

## Order code

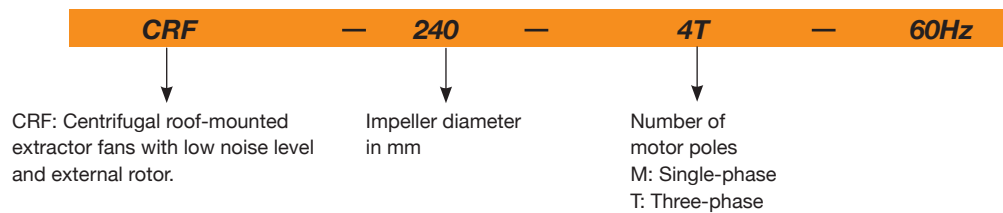

## Technical characteristics

**60Hz**

Model	Speed (r/min)	Maximum current current (A)		Maximum electric power (kW)	Maximum flow rate (m <sup>3</sup> /h)	Sound pressure level dB(A) <sup>(1)</sup>		Weight (kg)	Recommended VSD
		220-277V	380-480V			Intake	Discharge		
CRF-225-4M	1704	0.20		0.04	650	32.55	38.85	11	VSD1/M-0.5
CRF-250-4M	1728	0.31		0.06	950	33.60	39.90	12	VSD1/M-0.5
CRF-250-4T	1740		0.28	0.06	950	33.60	39.90	12	VSD3/A-RFT-1
CRF-315-4M	1680	0.60		0.14	2000	40.95	47.25	17	VSD1/M-0.5
CRF-315-4T	1716		0.35	0.14	2000	40.95	47.25	17	VSD3/A-RFT-1
CRF-315-6M	1128	0.38		0.08	1280	29.40	35.70	17	VSD1/M-0.5
CRF-315-6T	1080		0.20	0.07	1280	29.40	35.70	17	VSD3/A-RFT-1
CRF-355-4M	1680	0.75		0.17	2500	45.15	50.40	24	VSD1/M-0.5
CRF-355-4T	1680		0.45	0.18	2500	45.15	50.40	24	VSD3/A-RFT-1
CRF-355-6M	1116	0.46		0.10	1800	32.55	39.90	24	VSD1/M-0.5
CRF-355-6T	1140		0.32	0.10	1800	32.55	39.90	24	VSD3/A-RFT-1
CRF-400-4M	1620	1.20		0.26	2810	48.30	54.60	28	VSD1/M-0.5
CRF-400-4T	1656		0.60	0.27	2810	48.30	54.60	28	VSD3/A-RFT-1
CRF-400-6M	1128	0.72		0.14	2400	36.75	43.05	28	VSD1/M-0.5
CRF-400-6T	1080		0.40	0.15	2400	36.75	43.05	28	VSD3/A-RFT-1
CRF-450-4M	Available soon								
CRF-450-4T	Available soon								
CRF-450-6M	Available soon								
CRF-450-6T	Available soon								
CRF-500-4T	Available soon								
CRF-500-6M	Available soon								
CRF-500-6T	Available soon								

(1) The noise level values are pressures in dB(A) measured at a distance of 6 metres and at 2/3 of the maximum flow rate (2/3 Qmax).

## Acoustic characteristics

Sound power spectrum Lw(A) in dB(A) per Hz frequency band

Values taken during intake with 2/3 maximum flow rate (2/3Qmax).

Model	63	125	250	500	1000	2000	4000	8000
225	29	35	46	49	50	46	44	38
250	30	36	47	50	51	47	45	39
315-4	40	49	54	54	58	57	50	44
315-6	29	38	43	43	47	46	39	33
355-4	44	53	58	58	62	61	54	48
355-6	32	41	46	46	50	49	42	36
400-4	48	54	60	60	63	66	57	51
400-6	37	43	49	49	52	55	46	40

Values taken during discharge with 2/3 maximum flow rate (2/3Qmax).

Model	63	125	250	500	1000	2000	4000	8000
225	33	38	52	54	55	55	50	45
250	34	39	53	55	56	56	51	46
315-4	39	48	58	62	65	62	55	49
315-6	28	37	47	51	54	51	44	38
355-4	42	51	61	65	68	65	58	52
355-6	32	41	51	55	58	55	48	42
400-4	47	59	67	69	70	70	62	54
400-6	36	48	56	58	59	59	51	43

To obtain the Lwa noise power spectra in dB(A) in intake at maximum flow rate (Qmax), add the values set out in the following chart to the LpA sound pressure level given in the characteristic curves:

Frequency band (Hz)								
63	125	250	500	1000	2000	4000	8000	
2	9	15	15	18	18	11	5	

## Dimensions mm

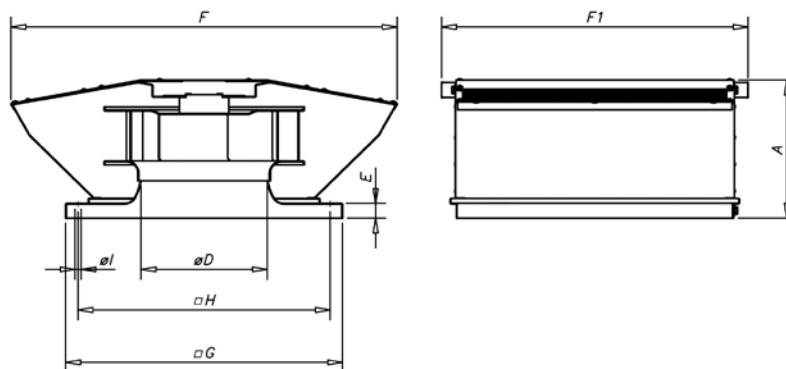

Model	A	ØD*	E	F	F1	G	H	øl
CRF-225	185	200	30	475	420	355	305	12
CRF-250	185	250	30	515	460	400	350	12
CRF-315	265	250	30	690	510	450	400	12
CRF-355	280	355	30	780	620	560	510	12
CRF-400	280	355	30	780	620	560	510	12

(\*) Recommended pipe nominal diameter

## Accessories



INT

RM

VSD3/A-RFT

VSD1/A-RFM  
VSD3/A-RFT

CUADROS

PA

MS

PT

SI

**Characteristic curves**

Q= Flow rate in m<sup>3</sup>/h, m<sup>3</sup>/s and cfm.

Pe= Static pressure in mm H<sub>2</sub>O, Pa and inwg.

**4T/4M=1500 r/min**

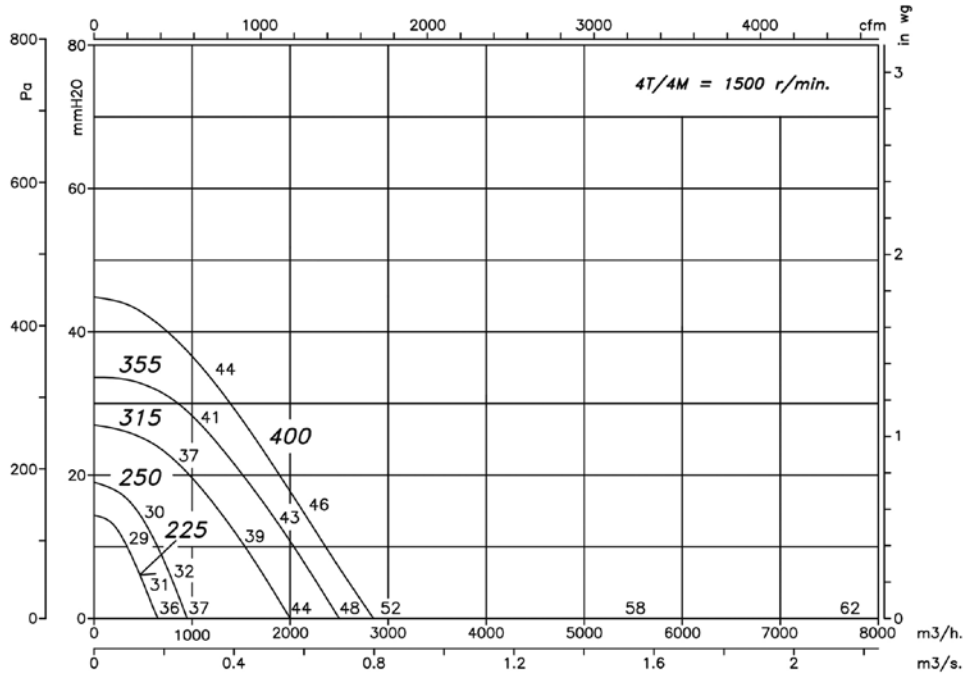

The Lp noise levels (dB(A)) indicated in the curves are pressures measured in a free field during intake, at 6 metres.

**6T/6M=1000 r/min**

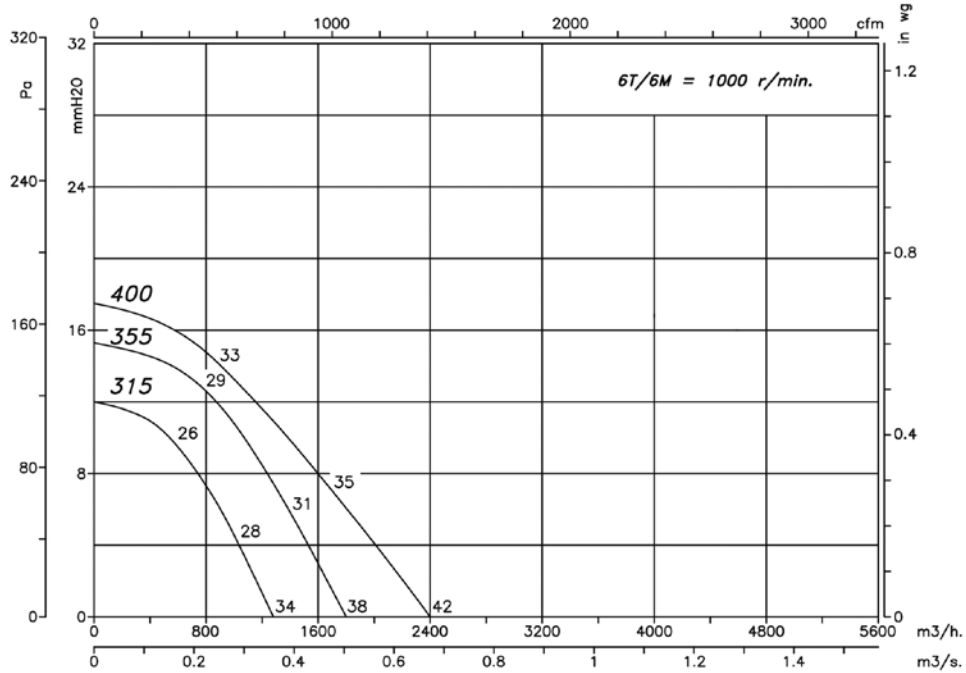

The Lp noise levels (dB(A)) indicated in the curves are pressures measured in a free field during intake, at 6 metres.

# HT

## Roof-mounted axial extractor fans with flat bases

Roof-mounted axial extractor fans with fibreglass reinforced plastic rotor and flat base for installing on roof.

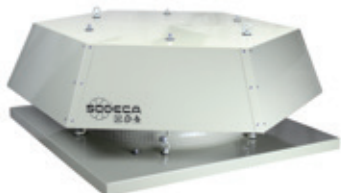

HT 25...63

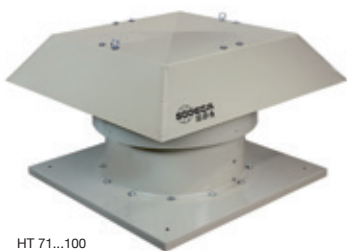

HT 71...100

### Fan:

- Painted, galvanised sheet steel support base.
- Fibreglass reinforced polyamide-6 rotors, except for 100 models, which have 4 poles in aluminium.
- Bird control grille.
- Rain cap made of painted galvanised sheet steel, with protection against corrosion.
- Airflow direction from Motor to Impeller.

### Motor:

- IE3 efficiency motors for powers equal to or greater than 0.75kW except single-phase, 2-speed and 8-pole.
- Class F motors with ball bearings, IP55 protection, except single-phase models from size 45 to size 63, IP54 protection.
- Multi voltage motor, special design valid for 220/380V 60Hz, 254/440V 60Hz, 265/460V 60Hz, 277/480V 60Hz
- Maximum temperature of air to be carried: -25°C +60 °C.

### Finish:

- Anti-corrosive finish of polyester resin polymerised at 190 °C, previously degreased with phosphate-free nanotechnological treatment.

### On request:

- Option of supply in the form of IMPULSION FANS.
- AL version rotors made of cast aluminium.
- Special windings for different voltages.
- ATEX-certified Category 2.

## Order code

**HT — 25 — 4T — I — 60Hz**

Roof-mounted axial extractor fans with flat bases

Rotor diameter in cm

Number of motor poles  
2=3500 r/min. 60 Hz  
4=1680 r/min. 60 Hz  
6=1080 r/min. 60 Hz

M=Single-phase  
T= Three-phase

I: Extractor fans  
A: impulsion fans

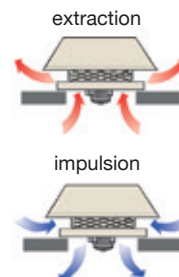

**60Hz**

## Technical characteristics

Model	Speed (r/min)	Maximum admissible current (A)		Installed power (kW)	Maximum flow rate (m³/h)	Sound pressure level dB(A)		Approx. weight (kg)
		220-277V	380-480V			Intake	Discharge	
HT-25-4T	1740	0.65	0.38	0.09	1080	41	40	12.5
HT-25-4M	1740	0.65		0.10	1080	41	40	12.5
HT-31-4T	1716	0.65	0.38	0.09	1800	47	46	13.3
HT-31-4M	1716	0.83		0.09	1800	47	46	13.5
HT-35-4T	1632	0.65	0.38	0.09	2600	48	47	17.5
HT-35-4M	1632	0.83		0.09	2600	48	47	17.5
HT-40-4T	1680	1.66	0.96	0.25	4600	51	50	21
HT-40-4M	1680	2.00		0.25	4600	51	50	21
HT-45-4T	1656	2.02	1.17	0.37	6500	55	53	29
HT-45-4M	1650	2.76		0.37	6500	55	54	30.5
HT-50-4T	1656	2.92	1.69	0.55	8500	59	57	36
HT-50-4M	1620	4.40		0.55	8500	59	57	39
HT-56-4T	1740	3.10	1.79	0.75	9800	61	57	35
HT-56-4M	1740	5.05		0.75	9800	61	57	37
HT-56-6T	1140	1.51	0.87	0.25	6600	48	46	46
HT-56-6M	1140	2.07		0.25	6600	48	46	46
HT-63-4T	1740	4.03	2.32	1.10	14000	63	59	65.8
HT-63-6T	1140	2.24	1.30	0.37	9200	52	49	61.8
HT-63-6M	1140	2.69		0.37	9200	52	49	61.8
HT-71-4T	1740	5.96	3.44	1.50	18000	69	67	64

**Technical characteristics**

Model	Speed (r/min)	Maximum admissible current (A)		Installed power (kW)	Maximum flow rate (m³/h)	Sound pressure level dB(A)		Approx. weight (kg)
		220-277V	380-480V			Intake	Discharge	
HT-71-6T	1140	2.99	1.73	0.55	12200	58	56	64.9
HT-71-6M	1140	3.84		0.55	12200	58	56	64.9
HT-80-4T	1740	8.36	4.83	2.20	26200	73	70	87.8
HT-80-6T	1140	4.88	2.82	1.10	18000	64	61	81.8
HT-90-4T	1740	10.96	6.33	3.00	31500	77	74	94
HT-90-6T	1140	6.42	3.71	1.50	21200	68	65	91
HT-100-4T-7.5	1740		11.60	5.50	37000	80	77	114
HT-100-4T-10	1740		13.90	7.50	44000	84	81	125
HT-100-6T-2	1128	6.42	3.71	1.50	25000	71	68	102
HT-100-6T-3	1152	9.30	5.30	2.20	28200	75	72	106

**Acoustic characteristics**

The indicated values are determined by measuring the pressure and sound power levels in dB(A) obtained in a free field at a distance of 6 m.

Sound power spectrum Lw(A) in dB(A) frequency band in [Hz]

Values taken during intake with maximum flow rate (Qmax)

Model	63	125	250	500	1000	2000	4000	8000
25	27	37	54	54	62	58	51	42
31	33	43	60	60	68	64	57	48
35	34	44	61	61	69	65	58	49
40	28	45	57	65	70	70	66	59
45	32	49	61	69	74	74	70	63
50	36	53	65	73	78	78	74	67
56-4	38	55	67	75	80	80	76	69
56-6	25	42	54	62	67	67	63	56
63-4	40	57	69	77	82	82	78	71
63-6	29	46	58	66	71	71	67	60
71-4	46	63	75	83	88	88	84	77
71-6	35	52	64	72	77	77	73	66
80-4	57	78	85	90	93	89	82	71
80-6	48	69	76	81	84	80	73	62
90-4	61	82	89	94	97	93	86	75
90-6	52	73	80	85	88	84	77	66
100-4-7.5	64	85	92	97	100	96	89	78
100-4-10	68	89	96	101	104	100	93	82
100-6-2	55	76	83	88	91	87	80	69
100-6-3	59	80	87	92	95	91	84	73

Values taken during discharge with maximum flow rate (Qmax)

Model	63	125	250	500	1000	2000	4000	8000
25	26	36	53	53	61	57	50	41
31	32	42	59	59	67	63	56	47
35	33	43	60	60	68	64	57	48
40	27	44	56	64	69	69	65	58
45	30	47	59	67	72	72	68	61
50	34	51	63	71	76	76	72	65
56-4	34	51	63	71	76	76	72	65
56-6	23	40	52	60	65	65	61	54
63-4	36	53	65	73	78	78	74	67
63-6	26	43	55	63	68	68	64	57
71-4	44	61	73	81	86	86	82	75
71-6	33	50	62	70	75	75	71	64
80-4	54	75	82	87	90	86	79	68
80-6	45	66	73	78	81	77	70	59
90-4	58	79	86	91	94	90	83	72
90-6	49	70	77	82	85	81	74	63
100-4-7.5	61	82	89	94	97	93	86	75
100-4-10	65	86	93	98	101	97	90	79
100-6-2	52	73	80	85	88	84	77	66
100-6-3	56	77	84	89	92	88	81	70

**Dimensions mm**

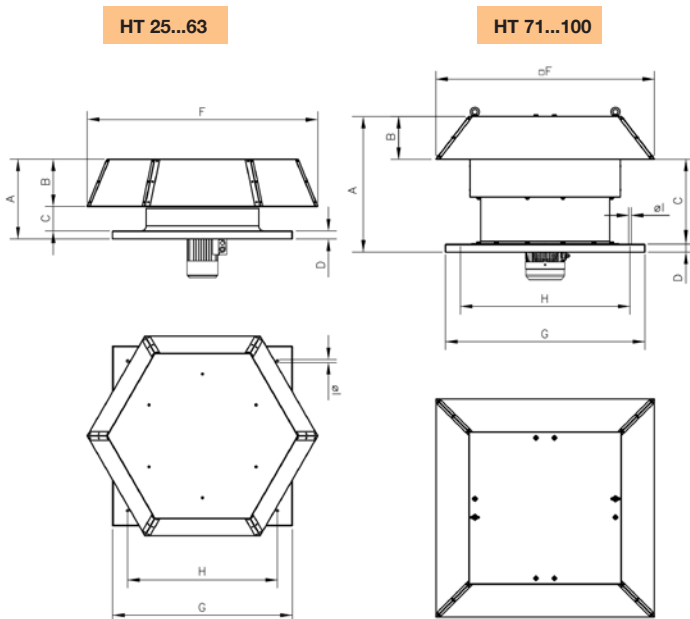

Model	A	B	C	D	F	G	H	I
HT-25	223	140	43	40	635	450	360	12
HT-31	245	140	65	40	635	500	410	12
HT-35	270	169	61	40	808	560	450	12
HT-40	295	169	86	40	808	630	530	12
HT-45	342	202	90	50	923	710	590	12
HT-50	373	238	85	50	1154	800	680	12
HT-56	402	238	124	40	1154	900	750	14
HT-63	457	277	141	40	1384	1000	850	14
HT-71	759	195	524	40	1123	1000	850	14
HT-80	790	216	524	50	1252	1150	1000	14
HT-90	920	232	638	50	1380	1150	1000	14
HT-100	1055	252	753	50	1527	1250	1100	14

**Characteristic curves**

Q= Flow rate in m<sup>3</sup>/h, m<sup>3</sup>/s and cfm.

Pe= Static pressure in mm H<sub>2</sub>O, Pa and inwg.

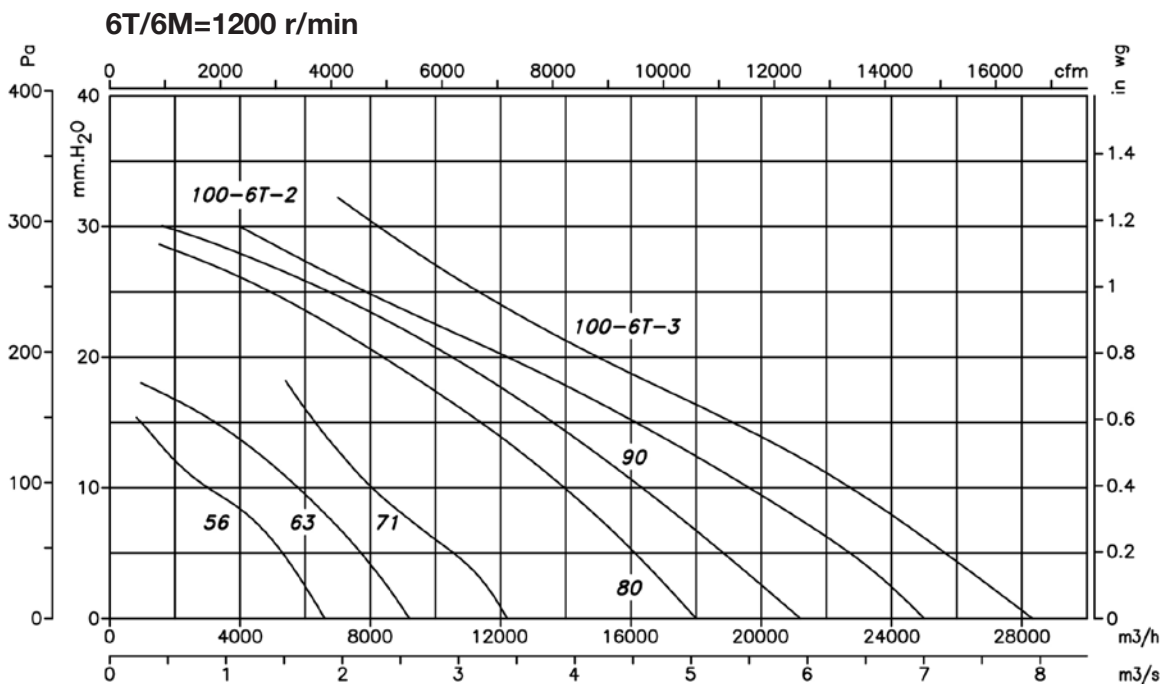
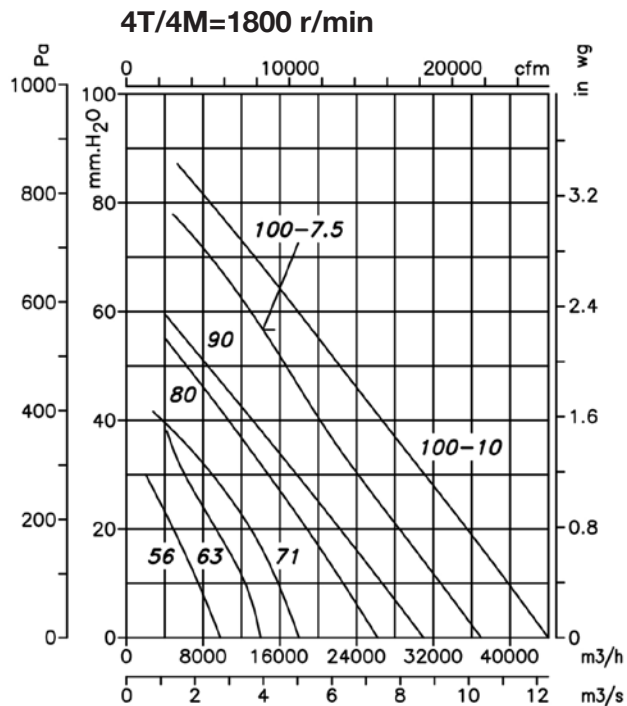
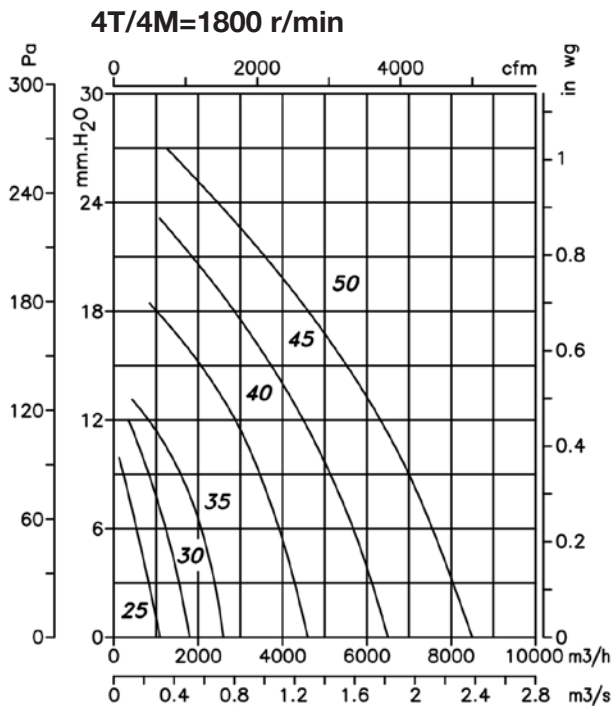

**Accessories**



INT

RM

VSD3/A-RFT  
VSD1/A-RFM

CUADROS

BTUB

MS

PA

OP

S

SI

BS



# HTMH

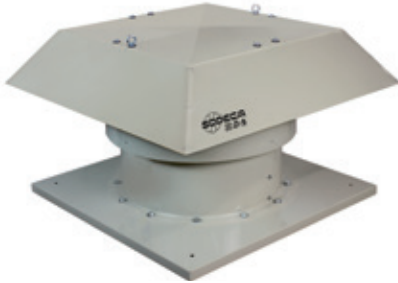

## Roof-mounted multifunctional extractor fans for large flow rates

Roof-mounted multifunctional extractor fans with robust structures for extraction operations with large flow rates.

**Fan:**

- Painted, galvanised sheet steel support base.
- Cast aluminium orientable rotors.
- Anti-contact protective grille pursuant to standard UNE-EN ISO 12499.
- Painted, galvanised sheet steel rain cap, with natural air outlet.

**Motor:**

- IE3 efficiency motors for powers equal to or greater than 0.75kW except single-phase, 2-speed and 8-pole.
- Class F motors with ball bearings, IP55 protection and with 1 or 2 speeds, depending on model.
- Multi voltage motor, special design valid for 220/380V 60Hz, 254/440V 60Hz, 265/460V 60Hz, 277/480V 60Hz
- Operating temperature: -25 °C + 50 °C.

**On request:**

- ATEX and 2-speed motors.
- Made entirely of stainless steel.
- Made of hot dip galvanised steel.
- Marine motors for naval applications, certified for essential service in accordance with different classification entities (BV, DNV, LR).
- CE, NEMA, UL, CSA motors.
- C5M quality surface finish.

**Finish:**

- Anti-corrosive finish of polyester resin polymerised at 190°C, previously degreased with phosphate-free nanotechnological treatment.
- C4H quality surface finish

### Order code

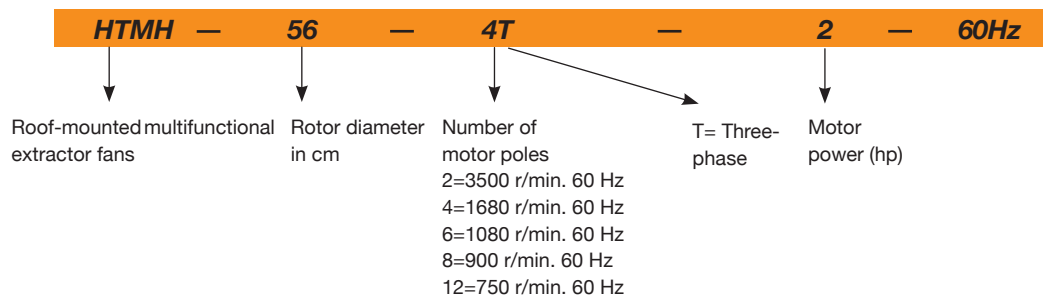

60Hz

### Technical characteristics

Model	Speed (r/min)	Maximum admissible current (A)		Installed power (kW)	Maximum flow rate (m³/h)	Sound pressure (1) level dB(A)		Approx. weight (kg)
		220-277V	380-480V			Intake	Discharge	
HTMH-56-4T-1	1692	2.83	1.63	0.75	10545	65.10	61.95	67
HTMH-56-4T-1.5	1680	4.03	2.32	1.10	11400	66.15	63.00	69
HTMH-56-4/8T-1.5	1728 / 852		2.90 / 1.30	1.10 / 0.25	11400 / 5700	66.15 / 50.40	63.00 / 47.25	67
HTMH-56-6T-0.75	1092	2.59	1.49	0.55	8170	53.55	51.45	67
HTMH-63-4T-1.5	1680	4.03	2.32	1.10	13870	68.25	65.10	81
HTMH-63-4/8T-1.5	1728 / 852		2.90 / 1.30	1.10 / 0.25	13870 / 6935	68.25 / 52.50	65.10 / 49.35	79
HTMH-63-4T-2	1728	5.67	3.26	1.50	15485	69.30	66.15	87
HTMH-63-4/8T-2	1704 / 840		3.50 / 1.50	1.50 / 0.37	15485 / 7742	69.30 / 53.55	66.15 / 50.40	80
HTMH-63-4T-3	1722	8.07	4.64	2.20	17955	70.35	67.20	96
HTMH-63-4/8T-3	1716 / 852		4.90 / 1.70	2.20 / 0.45	17955 / 8977	70.35 / 54.60	67.20 / 51.45	86
HTMH-63-6T-0.75	1092	2.59	1.49	0.55	10260	58.8	56.70	79
HTMH-63-6T-1	1110	3.39	1.95	0.75	11305	59.85	57.75	84
HTMH-71-4T-2	1728	5.67	3.26	1.50	16150	72.45	69.30	93
HTMH-71-4/8T-2	1704 / 840		3.50 / 1.50	1.50 / 0.37	16150 / 8075	72.45 / 56.70	69.30 / 53.55	86
HTMH-71-4T-3	1722	8.07	4.64	2.20	18430	74.55	71.40	101
HTMH-71-4/8T-3	1716 / 852		4.90 / 1.70	2.20 / 0.45	18430 / 9215	74.55 / 58.80	71.40 / 55.65	91
HTMH-71-4T-4	1704	10.70	6.17	3.00	22610	75.60	72.45	104

### Technical characteristics

Model	Speed (r/min)	Maximum admissible current (A)		Installed power (kW)	Maximum flow rate (m <sup>3</sup> /h)	Sound pressure (1) level dB(A)		Approx. weight (kg)
		220-277V	380-480V			Intake	Discharge	
HTMH-71-4/8T-4	1716 / 852		6.50 / 2.30	3.00 / 0.60	22610 / 11305	75.60 / 59.85	72.45 / 56.70	98
HTMH-71-6T-1	1110	3.39	1.95	0.75	13205	60.90	58.80	90
HTMH-71-6T-1.5	1110	4.83	2.78	1.10	16245	61.95	59.85	94
HTMH-80-4T-4	1704	10.70	6.17	3.00	27600	76.65	73.50	127
HTMH-80-4/8T-4	1716 / 852		6.50 / 2.30	3.00 / 0.60	27600 / 13800	76.65 / 60.90	73.50 / 57.75	121
HTMH-80-4T-5.5	1728	14.10	8.12	4.00	30176	77.70	74.55	136
HTMH-80-4/8T-5.5	1716 / 852		8.20 / 2.90	4.00 / 0.80	30176 / 15088	77.70 / 61.95	74.55 / 58.80	125
HTMH-80-6T-1.5	1110	4.83	2.78	1.10	19412	65.10	63.00	117
HTMH-80-6T-2	1128	6.45	3.71	1.50	22172	66.15	64.05	122
HTMH-80-6T-3	1146	10.30	5.94	2.20	24932	67.20	65.10	132
HTMH-80-8T-1	846	4.68	2.70	0.75	16376	64.05	63.00	117
HTMH-90-4T-5.5	1728	14.10	8.12	4.00	35052	82.95	79.80	158
HTMH-90-4/8T-5.5	1716 / 852		8.20 / 2.90	4.00 / 0.80	35052 / 17526	82.95 / 67.20	79.80 / 64.05	147
HTMH-90-4T-7.5	1752		10.50	5.50	38456	85.05	81.90	176
HTMH-90-4/8T-7.5	1740 / 864		11.80 / 3.80	5.50 / 1.10	38456 / 19228	85.05 / 69.30	81.90 / 66.15	166
HTMH-90-4T-10 IE3	1758		13.90	7.50	41308	86.10	82.95	194
HTMH-90-4/8T-9	1752 / 870		15.30 / 5.40	7.50 / 1.50	41308 / 20654	86.10 / 70.35	82.95 / 67.20	175
HTMH-90-6T-3	1146	10.30	5.94	2.20	29256	71.40	69.30	154
HTMH-90-6/12T-3	1128 / 564		5.60 / 2.20	2.20 / 0.37	29256 / 14628	71.40 / 55.65	69.30 / 53.55	148
HTMH-90-6T-4	1152	12.70	7.30	3.00	32016	72.45	70.35	177
HTMH-90-6/12T-4	1152 / 576		9.00 / 3.50	3.00 / 0.55	32016 / 16008	72.45 / 56.70	70.35 / 54.60	166
HTMH-90-8T-1	846	4.68	2.70	0.75	17020	64.05	63.00	139
HTMH-90-8T-2	846	7.10	4.10	1.50	19596	66.15	65.10	150
HTMH-100-4T-7.5	1752		10.50	5.50	40756	88.20	85.05	200
HTMH-100-4/8T-7.5	1740 / 864		11.80 / 3.80	5.50 / 1.10	40756 / 20378	88.20 / 72.45	85.05 / 69.30	190
HTMH-100-4T-10 IE3	1758		13.90	7.50	47564	89.25	86.10	218
HTMH-100-4/8T-9	1752 / 870		15.30 / 5.40	7.50 / 1.50	44528 / 22264	88.20 / 72.45	85.05 / 69.30	199
HTMH-100-4T-15 IE3	1764		20.90	11.00	51336	90.30	87.15	253
HTMH-100-4/8T-14	1764 / 870		23.20 / 8.70	11.00 / 2.80	48300 / 24150	89.25 / 73.50	86.10 / 70.35	230
HTMH-100-6T-3	1146	10.30	5.94	2.20	32476	77.70	75.60	178
HTMH-100-6/12T-3	1128 / 564		5.60 / 2.20	2.20 / 0.37	32476 / 16238	77.70 / 61.95	75.60 / 59.85	172
HTMH-100-6T-4	1152	12.70	7.30	3.00	35420	78.75	76.65	201
HTMH-100-6/12T-4	1152 / 576		9.00 / 3.50	3.00 / 0.55	35420 / 17710	78.75 / 63.00	76.65 / 60.90	190
HTMH-100-6T-5.5	1152	16.50	9.46	4.00	40020	79.80	77.70	208
HTMH-100-6/12T-5.5	1164 / 576		11.00 / 4.00	4.00 / 0.65	40020 / 20010	79.80 / 64.05	77.70 / 61.95	200
HTMH-100-8T-3	846	9.53	5.50	2.20	26404	72.45	71.40	186
HTMH-100-8T-4	846	12.82	7.40	3.00	28704	73.50	72.45	193
HTMH-125-4T/3-10 IE3	1758		13.90	7.50	55250	78.75	75.60	337
HTMH-125-4T/3-15 IE3	1764		21.40	11.00	72150	79.80	76.65	382
HTMH-125-4T/3-20 IE3	1758		28.70	15.00	83120	81.90	78.75	377
HTMH-125-4T/6-15 IE3	1764		21.40	11.00	66800	79.80	76.65	398
HTMH-125-4T/6-20 IE3	1758		28.70	15.00	72900	79.80	76.65	393
HTMH-125-4T/9-20 IE3	1758		28.70	15.00	76310	78.75	75.60	408
HTMH-125-6T/6-5.5	1152	16.50	9.46	4.00	47760	66.15	64.05	343
HTMH-125-6T/6-7.5	1152		12.80	5.50	55600	66.15	64.05	347
HTMH-125-6T/6-10 IE3	1164		14.80	7.50	66170	68.25	66.15	369
HTMH-125-6T/6-15 IE3	1164		22.00	11.00	76380	70.35	68.25	399
HTMH-125-6T/9-7.5	1152		12.80	5.50	50000	67.20	65.10	362
HTMH-125-6T/9-10 IE3	1164		14.80	7.50	59340	67.20	65.10	384
HTMH-125-6T/9-15 IE3	1164		22.00	11.00	71890	70.35	68.25	414
HTMH-125-6T/9-20 IE3	1170		28.00	15.00	83660	73.50	71.40	467
HTMH-125-8T/6-4	846	12.82	7.40	3.00	47510	58.80	57.75	328
HTMH-125-8T/6-5.5	852	16.11	9.30	4.00	52770	60.90	59.85	345
HTMH-125-8T/6-7.5	852		12.00	5.50	60410	63.00	61.95	361
HTMH-125-8T/6-10	870		16.00	7.50	66030	64.05	63.00	389
HTMH-125-8T/9-5.5	852	16.11	9.30	4.00	51330	60.90	59.85	360
HTMH-125-8T/9-7.5	852		12.00	5.50	54480	64.05	63.00	376
HTMH-125-8T/9-10	870		16.00	7.50	65660	66.15	65.10	404
HTMH-125-8T/9-15	864		24.00	11.00	73870	67.20	66.15	426

(1) The noise level values are pressures in dB(A) measured at a distance of 6 metres in a free field.

Acoustic characteristics

Sound power spectrum Lw(A) in dB(A) frequency band in [Hz]

Values taken during intake with maximum flow rate

Model	63	125	250	500	1000	2000	4000	8000
56-4-1	46	67	74	79	82	78	71	60
56-4-1.5	47	68	75	80	83	79	72	61
56-6-0,75	35	56	63	68	71	67	60	49
56-8-1.5	32	53	60	65	68	64	57	46
63-4-1,5	49	70	77	82	85	81	74	63
63-4-2	50	71	78	83	86	82	75	64
63-4-3	51	72	79	84	87	83	76	65
63-6-0,75	40	61	68	73	76	72	65	54
63-6-1	41	62	69	74	77	73	66	55
63-8-1,5	34	55	62	67	70	66	59	48
63-8-2	35	56	63	68	71	67	60	49
63-8-3	36	57	64	69	72	68	61	50
71-4-2	53	74	81	86	89	85	78	67
71-4-3	55	76	83	88	91	87	80	69
71-4-4	56	77	84	89	92	88	81	70
71-6-1	42	63	70	75	78	74	67	56
71-6-1,5	43	64	71	76	79	75	68	57
71-8-2	38	59	66	71	74	70	63	52
71-8-3	40	61	68	73	76	72	65	54
71-8-4	41	62	69	74	77	73	66	55
80-4-4	57	78	85	90	93	89	82	71
80-4-5,5	58	79	86	91	94	90	83	72
80-6-1,5	46	67	74	79	82	78	71	60
80-6-2	47	68	75	80	83	79	72	61
80-6-3	48	69	76	81	84	80	73	62
80-8-1	45	66	73	78	81	77	70	59
80-8-4	42	63	70	75	78	74	67	56
80-8-5,5	43	64	71	76	79	75	68	57
90-4-5,5	63	84	91	96	99	95	88	77
90-4-7,5	65	86	93	98	101	97	90	79
90-4-9	66	87	94	99	102	98	91	80
90-4-10	66	87	94	99	102	98	91	80
90-6-3	52	73	80	85	88	84	77	66
90-6-4	53	74	81	86	89	85	78	67
90-8-1	45	66	73	78	81	77	70	59
90-8-2	47	68	75	80	83	79	72	61
90-8-5,5	48	69	76	81	84	80	73	62
90-8-7,5	50	71	78	83	86	82	75	64
90-8-9	51	72	79	84	87	83	76	65
90-12-3	37	58	65	70	73	69	62	51
90-12-4	38	59	66	71	74	70	63	52
100-4-7,5	68	89	96	101	104	100	93	82
100-4-9	68	89	96	101	104	100	93	82
100-4-10	69	90	97	102	105	101	94	83
100-4-14	69	90	97	102	105	101	94	83
100-4-15	70	91	98	103	106	102	95	84
100-6-3	58	79	86	91	94	90	83	72
100-6-4	59	80	87	92	95	91	84	73
100-6-5,5	60	81	88	93	96	92	85	74
100-8-3	53	74	81	86	89	85	78	67
100-8-4	54	75	82	87	90	86	79	68
100-8-7,5	53	74	81	86	89	85	78	67
100-8-9	53	74	81	86	89	85	78	67
100-8-14	54	75	82	87	90	86	79	68
100-12-3	43	64	71	76	79	75	68	57
100-12-4	44	65	72	77	80	76	69	58
100-12-5,5	45	66	73	78	81	77	70	59
125-4T/3-10	66	73	84	94	95	90	82	78
125-4T/3-15	67	74	85	95	96	91	83	79
125-4T/3-20	69	76	87	97	98	93	85	81
125-4T/6-15	63	72	87	94	97	91	85	81
125-4T/6-20	63	72	87	94	97	91	85	81
125-4T/9-20	62	71	87	93	95	89	84	80
125-6T/6-5,5	56	66	78	81	83	79	68	64
125-6T/6-7,5	56	66	78	81	83	79	68	64
125-6T/6-10	58	68	80	83	85	81	70	66
125-6T/6-15	60	70	82	85	87	83	72	68
125-6T/9-7,5	54	65	79	83	83	81	70	66
125-6T/9-10	54	65	79	83	83	81	70	66
125-6T/9-15	57	68	82	86	86	84	73	69
125-6T/9-20	60	71	85	89	89	87	76	72
125-8T/6-4	50	59	70	75	75	69	58	54
125-8T/6-5,5	52	61	72	77	77	71	60	56
125-8T/6-7,5	54	63	74	79	79	73	62	58
125-8T/6-10	55	64	75	80	80	74	63	59
125-8T/9-5,5	49	61	70	76	78	72	61	57
125-8T/9-7,5	52	64	73	79	81	75	64	60
125-8T/9-10	54	66	75	81	83	77	66	62
125-8T/9-15	55	67	76	82	84	78	67	63

Values taken during discharge with maximum flow rate

Model	63	125	250	500	1000	2000	4000	8000
56-4-1	43	64	71	76	79	75	68	57
56-4-1,5	44	65	72	77	80	76	69	58
56-6-0,75	33	54	61	66	69	65	58	47
56-8-1,5	29	50	57	62	65	61	54	43
63-4-1,5	46	67	74	79	82	78	71	60
63-4-2	47	68	75	80	83	79	72	61
63-4-3	48	69	76	81	84	80	73	62
63-6-0,75	38	59	66	71	74	70	63	52
63-6-1	39	60	67	72	75	71	64	53
63-8-1,5	31	52	59	64	67	63	56	45
63-8-2	32	53	60	65	68	64	57	46
63-8-3	33	54	61	66	69	65	58	47
71-4-2	50	71	78	83	86	82	75	64
71-4-3	52	73	80	85	88	84	77	66
71-4-4	53	74	81	86	89	85	78	67
71-6-1	40	61	68	73	76	72	65	54
71-6-1,5	41	62	69	74	77	73	66	55
71-8-2	35	56	63	68	71	67	60	49
71-8-3	37	58	65	70	73	69	62	51
71-8-4	38	59	66	71	74	70	63	52
80-4-4	54	75	82	87	90	86	79	68
80-4-5,5	55	76	83	88	91	87	80	69
80-6-1,5	44	65	72	77	80	76	69	58
80-6-2	45	66	73	78	81	77	70	59
80-6-3	46	67	74	79	82	78	71	60
80-8-1	44	65	72	77	80	76	69	58
80-8-4	39	60	67	72	75	71	64	53
80-8-5,5	40	61	68	73	76	72	65	54
90-4-5,5	60	81	88	93	96	92	85	74
90-4-7,5	62	83	90	95	98	94	87	76
90-4-9	63	84	91	96	99	95	88	77
90-4-10	63	84	91	96	99	95	88	77
90-6-3	50	71	78	83	86	82	75	64
90-6-4	51	72	79	84	87	83	76	65
90-8-1	44	65	72	77	80	76	69	58
90-8-2	46	67	74	79	82	78	71	60
90-8-5,5	45	66	73	78	81	77	70	59
90-8-7,5	47	68	75	80	83	79	72	61
90-8-9	48	69	76	81	84	80	73	62
90-12-3	35	56	63	68	71	67	60	49
90-12-4	36	57	64	69	72	68	61	50
100-4-7,5	65	86	93	98	101	97	90	79
100-4-9	65	86	93	98	101	97	90	79
100-4-10	66	87	94	99	102	98	91	80
100-4-14	66	87	94	99	102	98	91	80
100-4-15	67	88	95	100	103	99	92	81
100-6-3	56	77	84	89	92	88	81	70
100-6-4	57	78	85	90	93	89	82	71
100-6-5,5	58	79	86	91	94	90	83	72
100-8-3	52	73	80	85	88	84	77	66
100-8-4	53	74	81	86	89	85	78	67
100-8-7,5	50	71	78	83	86	82	75	64
100-8-9	50	71	78	83	86	82	75	64
100-8-14	51	72	79	84	87	83	76	65
100-12-3	41	62	69	74	77	73	66	55
100-12-4	42	63	70	75	78	74	67	56
100-12-5,5	43	64	71	76	79	75	68	57
125-4T/3-10	63	70	81	91	92	87	79	75
125-4T/3-15	64	71	82	92	93	88	80	76
125-4T/3-20	66	73	84	94	95	90	82	78
125-4T/6-15	60	69	84	91	94	88	82	78
125-4T/6-20	60	69	84	91	94	88	82	78
125-4T/9-20	59	68	84	90	92	86	81	77
125-6T/6-5,5	54	64	76	79	81	77	66	62
125-6T/6-7,5	54	64	76	79	81	77	66	62
125-6T/6-10	56	66	78	81	83	79	68	64
125-6T/6-15	58	68	80	83	85	81	70	66
125-6T/9-7,5	52	63	77	81	81	79	68	64
125-6T/9-10	52	63	77	81	81	79	68	64
125-6T/9-15	55	66	80	84	84	82	71	67
125-6T/9-20	58	69	83	87	87	85	74	70
125-8T/6-4	49	58	69	74	74	68	57	53
125-8T/6-5,5	51	60	71	76	76	70	59	55
125-8T/6-7,5	53	62	73	78	78	72	61	57
125-8T/6-10	54	63	74	79	79	73	62	58
125-8T/9-5,5	48	60	69	75	77	71	60	56
125-8T/9-7,5	51	63	72	78	80	74	63	59
125-8T/9-10	53	65	74	80	82	76	65	61
125-8T/9-15	54	66	75	81	83	77	66	62

### Dimensions mm

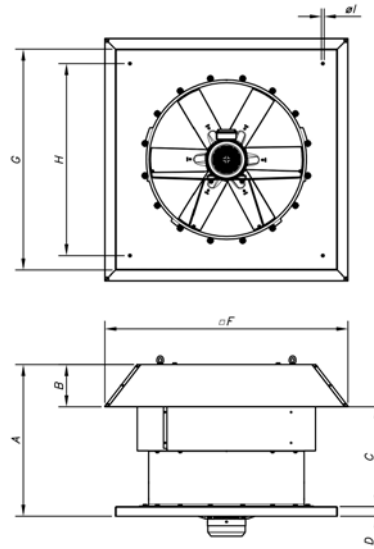

Model	A	B	C	D	F	G	H	I
HTMH-56	650	185	465	40	960	900	750	14
HTMH-63	680	215	465	40	1092	1000	850	14
HTMH-71	760	195	565	40	1120	1000	850	14
HTMH-80	790	215	575	50	1252	1150	1000	14
HTMH-90	910	232	678	50	1380	1150	1000	14
HTMH-100	1055	252	803	50	1527	1250	1100	14
HTMH-125	1170	310	859	50	1802	1425	1275	17

### Sound pressure validation depending on distance

The noise level may vary depending on the roof or tile structure.

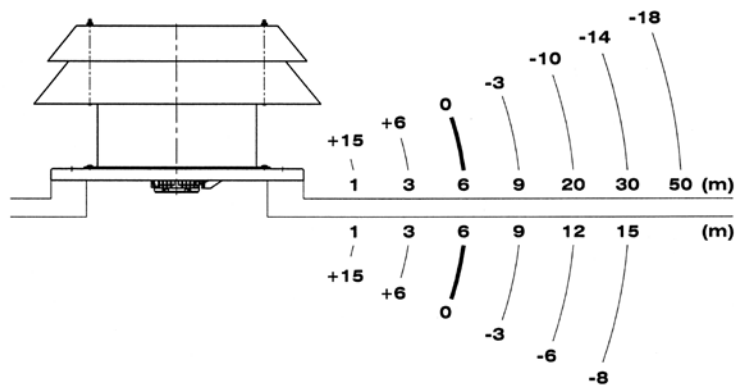

### Accessories



INT

AET

VSD3/A-RFT  
VSD1/A-RFM

RT

**Characteristic curves**

Q= Flow rate in m<sup>3</sup>/h, m<sup>3</sup>/s and cfm.

Pe= Static pressure in mm H<sub>2</sub>O, Pa and inwg.

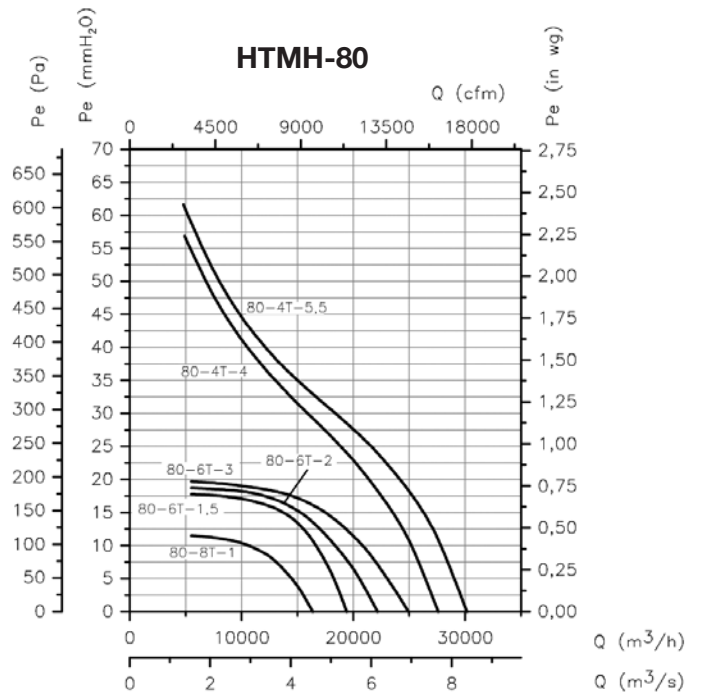
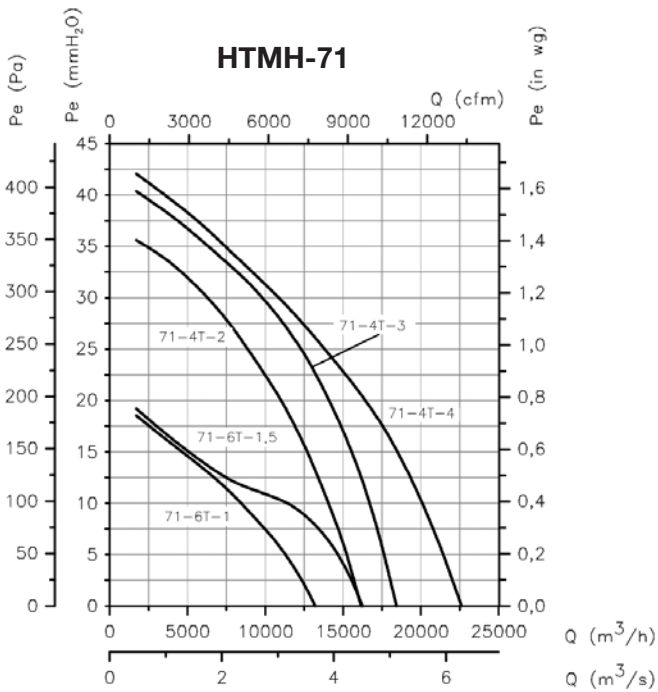
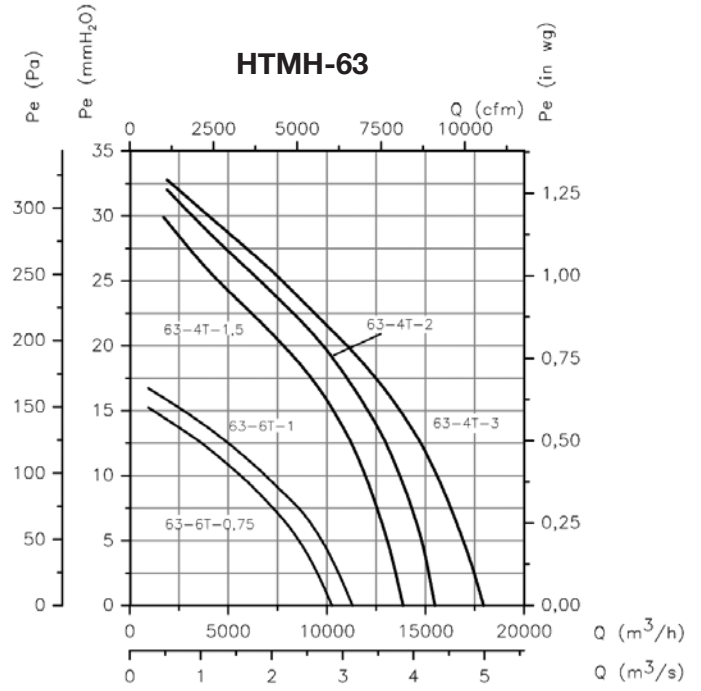
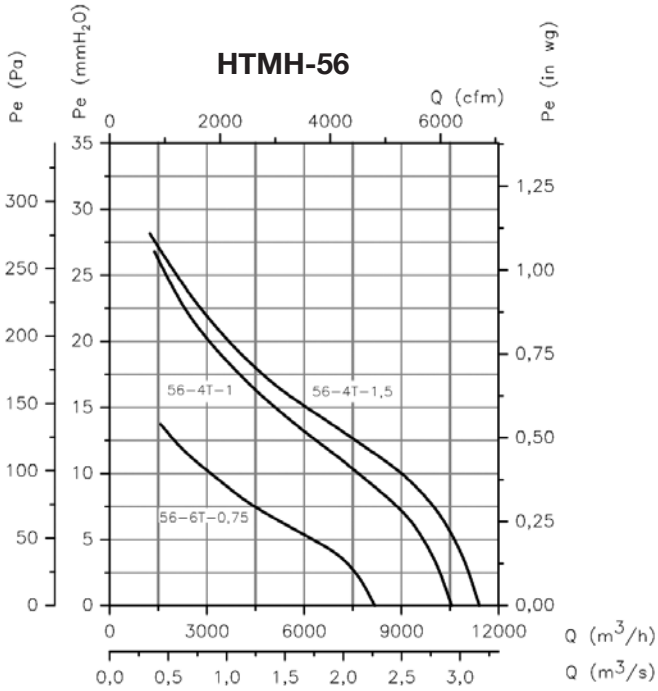

**Characteristic curves**

Q= Flow rate in m<sup>3</sup>/h, m<sup>3</sup>/s and cfm.

Pe= Static pressure in mm H<sub>2</sub>O, Pa and inwg.

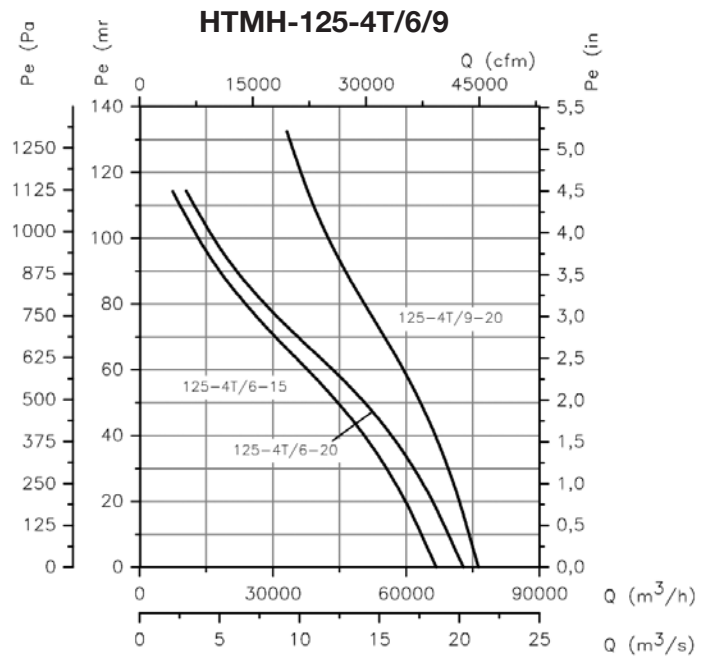
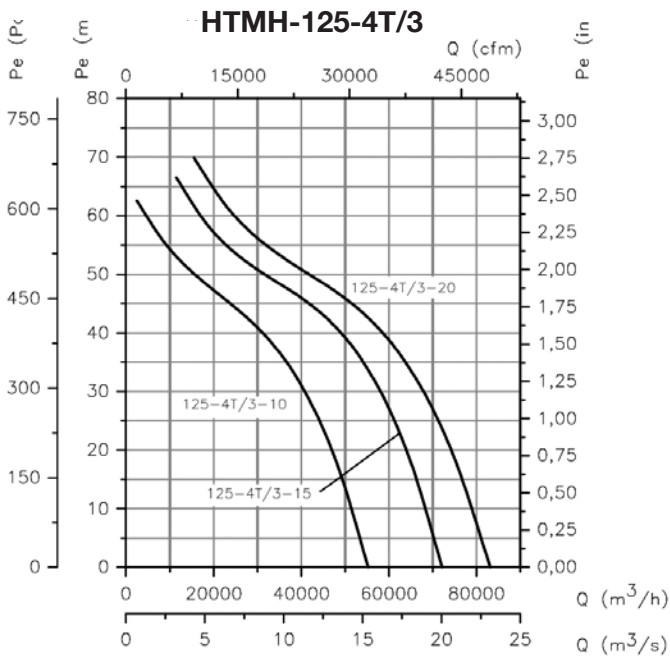
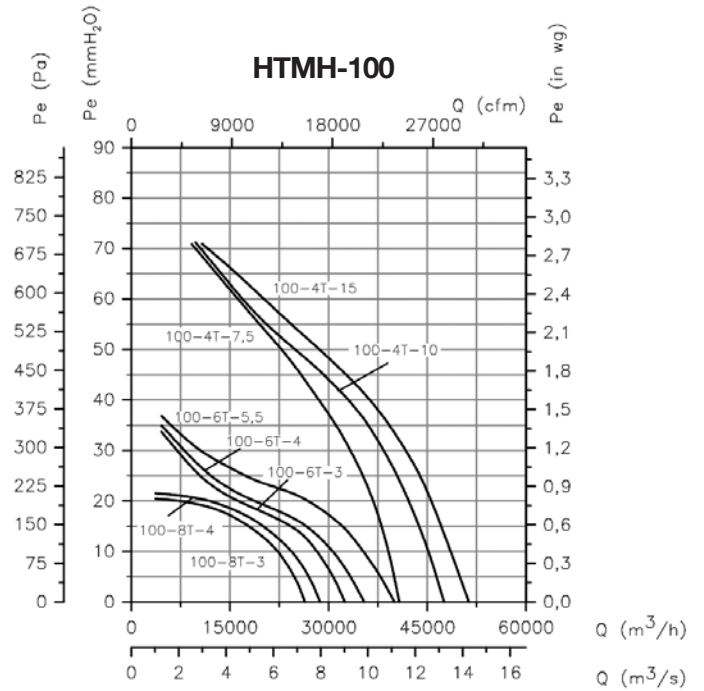
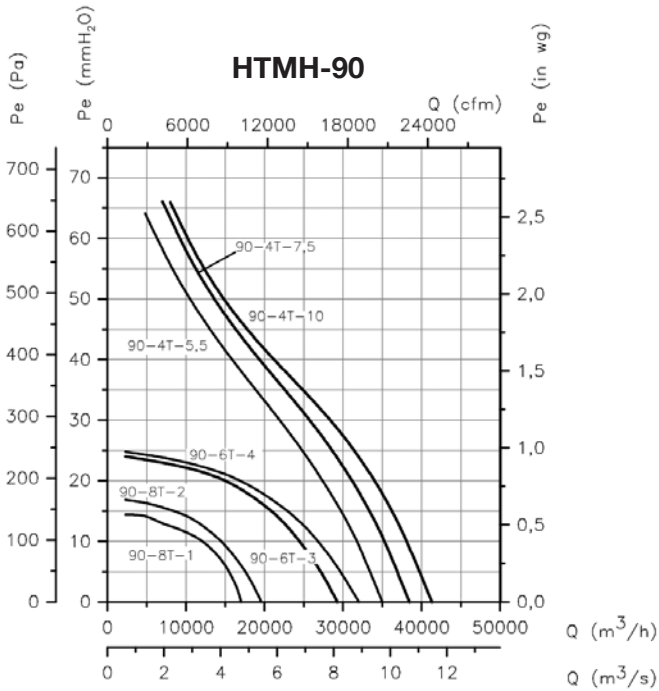

**Characteristic curves**

Q= Flow rate in m<sup>3</sup>/h, m<sup>3</sup>/s and cfm.

Pe= Static pressure in mm H<sub>2</sub>O, Pa and inwg.

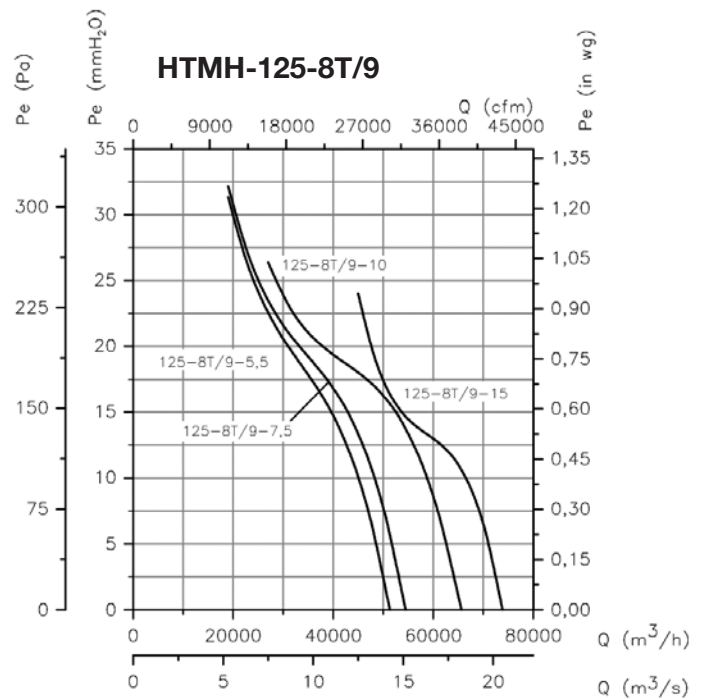
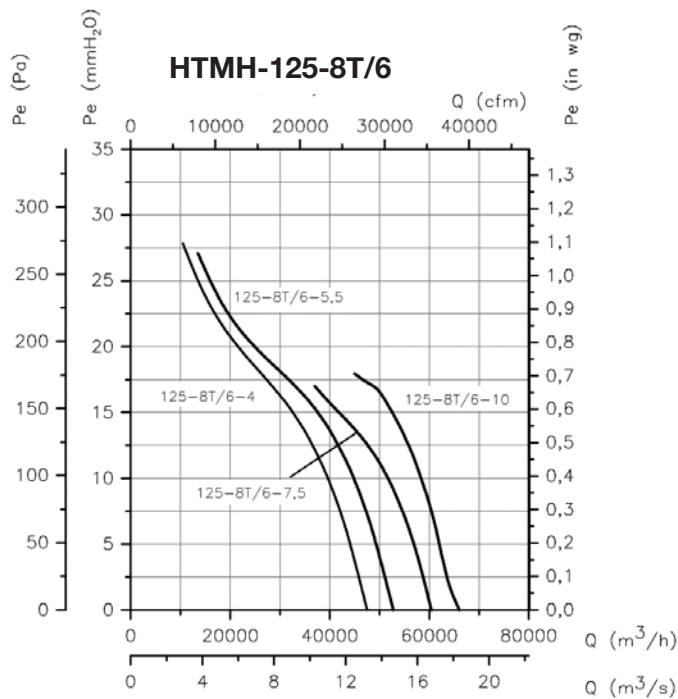
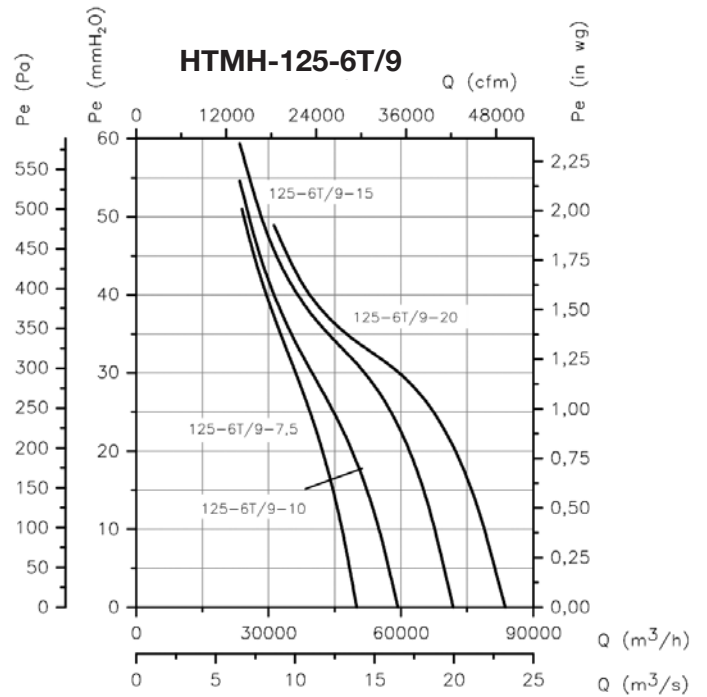
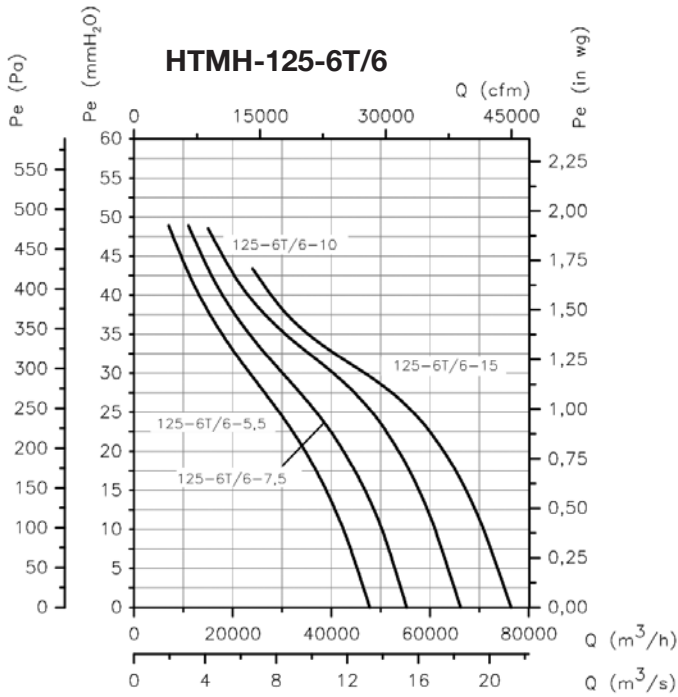

# HTMV



## Roof-mounted axial extractor fans with vertical air outlet

Roof-mounted axial extractor fans with vertical air outlet, designed for extracting large air volumes in industrial or similar premises.

### Fan:

- Galvanised sheet steel support base with anti-corrosive treatment.
- Cast aluminium orientable rotors.
- Anti-contact protective grille pursuant to standard UNE-EN ISO 12499.
- Anti-return hatch in aluminium sheet metal to prevent the entry of water when the fan is not operating.
- Airflow direction from Motor to Impeller.

### Motor:

- Class F motors with ball bearings and IP55 protection.
- IE3 efficiency motors for powers equal to or greater than 0.75kW except single-phase, 2-speed and 8-pole.
- Multi voltage motor, special design valid for 220/380V 60Hz, 254/440V 60Hz, 265/460V 60Hz, 277/480V 60Hz
- Maximum temperature of air to be carried: -20 °C +40 °C.

### Finish:

- Anti-corrosive finish of polyester resin polymerised at 190 °C, previously degreased with phosphate-free nanotechnological treatment.

### On request:

- Extractor fans with 2-speed motors.
- 2 and 8-pole fans depending on diameter.
- Special windings for different voltages and frequencies.
- Made entirely of stainless steel.
- Made of hot dip galvanised steel.

## Order code

From size 40 to size 100

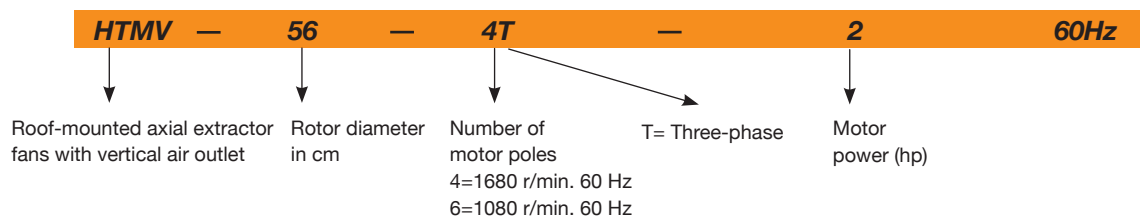

Size 125

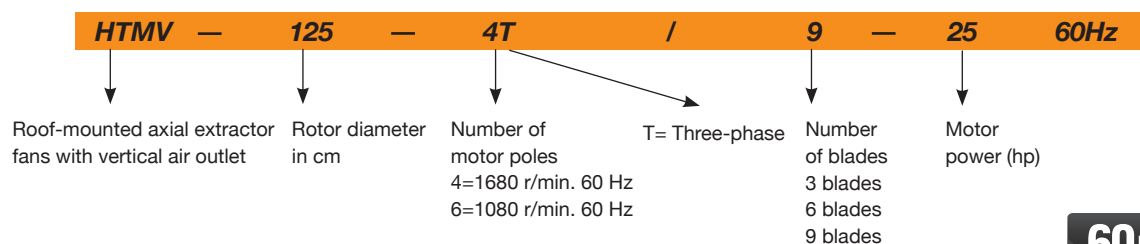

## Technical characteristics

60Hz

Model	Speed (r/min)	Maximum admissible current (A)		Installed power (kW)	Maximum flow rate (m <sup>3</sup> /h)	Sound pressure (1) level dB(A)		Approx. weight (kg)
		220-277V	380-480V			Intake	Discharge	
HTMV-40-4T-0.75	1656	2.92	1.69	0.55	4800	53.55	48.30	39
HTMV-40-6T-0.75	1080	2.99	1.73	0.55	3150	42.00	37.80	47
HTMV-45-4T-0.75	1656	2.92	1.69	0.55	7450	57.75	52.50	42
HTMV-45-6T-0.75	1080	2.99	1.73	0.55	4450	44.10	39.90	50
HTMV-50-4T-1 IE3	1704	2.82	1.62	0.75	9750	61.95	56.70	54
HTMV-50-6T-0.75	1080	2.99	1.73	0.55	7000	49.35	45.15	57
HTMV-56-4T-1 IE3	1704	2.82	1.62	0.75	11250	66.15	60.90	61
HTMV-56-4T-1.5 IE3	1746	4.07	2.34	1.1	13600	67.20	61.95	60
HTMV-56-4T-2 IE3	1728	5.41	3.11	1.5	15050	68.25	63.00	71
HTMV-56-6T-0.75	1080	2.99	1.73	0.55	10150	54.60	50.40	60
HTMV-63-4T-1.5 IE3	1746	4.07	2.34	1.1	17800	66.15	61.95	69
HTMV-63-4T-2 IE3	1728	5.41	3.11	1.5	19300	66.15	61.95	81
HTMV-63-4T-3 IE3	1722	7.93	4.56	2.2	22150	68.25	64.05	83
HTMV-63-4T-4 IE3	1728	10.7	6.15	3	24250	69.30	65.10	93
HTMV-63-6T-0.75	1080	2.99	1.73	0.55	13600	57.75	53.55	70



**Technical characteristics**

Model	Speed (r/min)	Maximum admissible current (A)		Installed power (kW)	Maximum flow rate (m³/h)	Sound pressure (1) level dB(A)		Approx. weight (kg)
		220-277V	380-480V			Intake	Discharge	
HTMV-63-6T-1 IE3	1128	3.36	1.93	0.75	15900	59.85	55.65	72
HTMV-71-4T-2 IE3	1728	5.41	3.11	1.5	20900	71.40	67.20	88
HTMV-71-4T-3 IE3	1722	7.93	4.56	2.2	25100	70.35	66.15	90
HTMV-71-4T-4 IE3	1728	10.7	6.15	3	27500	71.40	67.20	100
HTMV-71-6T-0.75	1080	2.99	1.73	0.55	16100	58.80	55.65	77
HTMV-71-6T-1 IE3	1128	3.36	1.93	0.75	17300	59.85	55.65	79
HTMV-71-6T-1.5 IE3	1134	4.68	2.69	1.1	19950	60.90	56.70	90
HTMV-80-4T-4 IE3	1728	10.7	6.15	3	30250	74.55	70.35	122
HTMV-80-4T-5.5 IE3	1740	13.9	8	4	32750	74.55	70.35	125
HTMV-80-6T-1.5 IE3	1134	4.68	2.69	1.1	21450	64.05	59.85	112
HTMV-80-6T-2 IE3	1140	6.43	3.7	1.5	25950	65.10	60.90	120
HTMV-80-6T-3 IE3	1140	9.08	5.22	2.2	29950	66.15	61.95	122
HTMV-90-4T-5.5 IE3	1740	13.9	8	4	38900	78.75	74.55	138
HTMV-90-4T-7.5 IE3	1758		10.3	5.5	46150	77.70	73.50	185
HTMV-90-4T-10 IE3	1758		13.9	7.5	50150	76.65	72.45	141
HTMV-90-6T-2 IE3	1140	6.43	3.7	1.5	28800	67.20	63.00	133
HTMV-90-6T-3 IE3	1140	9.08	5.22	2.2	34000	68.25	63.00	136
HTMV-90-6T-4 IE3	1164	12	6.91	3	38900	69.30	65.10	172
HTMV-100-4T-7.5 IE3	1758		10.3	5.5	46850	82.95	78.75	196
HTMV-100-4T-10 IE3	1758		13.9	7.5	57400	80.85	76.65	152
HTMV-100-4T-15 IE3	1764		21.4	11	66300	79.80	75.60	231
HTMV-100-4T-20 IE3	1758		28.7	15	76150	81.90	77.70	222
HTMV-100-6T-3 IE3	1140	9.08	5.22	2.2	37600	70.35	67.20	148
HTMV-100-6T-4 IE3	1164	12	6.91	3	41150	70.35	65.10	184
HTMV-100-6T-5.5 IE3	1152	15.6	8.99	4	47800	71.40	67.20	177
HTMV-125-4T/3-25 IE3	1764		33.6	18.5	98350	85.05	79.80	428
HTMV-125-4T/3-30 IE3	1770		40.6	22	110350	86.10	80.85	443
HTMV-125-4T/3-40 IE3	1776		55.9	30	125000	87.15	81.90	489
HTMV-125-4T/6-25 IE3	1764		33.6	18.5	92550	84.00	78.75	437
HTMV-125-4T/6-30 IE3	1770		40.6	22	98850	84.00	78.75	452
HTMV-125-4T/6-40 IE3	1776		55.9	30	117450	86.10	80.85	497
HTMV-125-4T/6-50 IE3	1776		69.2	37	131050	87.15	81.90	537
HTMV-125-4T/9-25 IE3	1764		33.6	18.5	79650	81.90	76.65	446
HTMV-125-4T/9-30 IE3	1770		40.6	22	88300	82.95	77.70	461
HTMV-125-4T/9-40 IE3	1776		55.9	30	104050	85.05	79.80	506
HTMV-125-4T/9-50 IE3	1776		69.2	37	118400	87.15	81.90	546
HTMV-125-6T/3-4 IE3	1164	12	6.91	3	46750	73.50	68.25	280
HTMV-125-6T/3-5.5 IE3	1152	15.6	8.99	4	55400	73.50	69.30	273
HTMV-125-6T/3-7.5 IE3	1164		11.2	5.5	68400	74.55	70.35	251
HTMV-125-6T/3-10 IE3	1164		14.8	7.5	79150	76.65	72.45	270
HTMV-125-6T/3-15 IE3	1164		22	11	87150	77.70	73.50	323
HTMV-125-6T/3-20 IE3	1170		28	15	91650	78.75	74.55	429
HTMV-125-6T/6-5.5 IE3	1152	15.6	8.99	4	51500	69.3	65.10	282
HTMV-125-6T/6-7.5 IE3	1164		11.2	5.5	60650	69.30	65.10	260
HTMV-125-6T/6-10 IE3	1164		14.8	7.5	72650	71.40	67.20	279
HTMV-125-6T/6-15 IE3	1164		22	11	85850	73.50	69.30	332
HTMV-125-6T/6-20 IE3	1170		28	15	92850	74.55	70.35	438
HTMV-125-6T/9-10 IE3	1164		14.8	7.5	63500	71.40	67.20	288
HTMV-125-6T/9-15 IE3	1164		22	11	77550	74.55	70.35	341
HTMV-125-6T/9-20 IE3	1170		28	15	92950	77.70	73.50	447

(1) The noise level values are pressures in dB(A) measured at a distance of 6 metres in a free field.

**Accessories**



## Acoustic characteristics

The indicated values are determined by measuring the pressure and sound power levels in dB(A) obtained in a free field at a distance of 6 m.

### Sound power spectrum Lw(A) in dB(A) frequency band in [Hz]

Values taken during intake with maximum flow rate

Model	63	125	250	500	1000	2000	4000	8000
40-4-0,75	36	57	64	69	72	68	61	50
40-6-0,75	25	46	53	58	61	57	50	39
45-4-0,75	40	61	68	73	76	72	65	54
45-6-0,75	27	48	55	60	63	59	52	41
50-4-1	44	64	72	77	79	76	69	58
50-6-0,75	32	52	60	65	67	64	57	46
56-4-1	48	68	76	81	83	80	73	62
56-4-1,5	49	69	77	82	84	81	74	63
56-4-2	50	70	78	83	85	82	75	64
56-6-0,75	37	57	65	70	72	69	62	51
63-4-1,5	48	68	76	81	83	80	73	65
63-4-2	52	68	76	81	83	80	73	66
63-4-3	53	70	78	83	85	82	77	67
63-4-4	54	71	79	84	86	83	78	68
63-6-0,75	42	60	68	73	75	72	65	56
63-6-1	43	62	70	75	77	74	67	57
71-4-2	53	73	81	86	88	85	78	70
71-4-3	58	72	80	85	87	84	77	71
71-4-4	59	73	81	86	88	85	78	72
71-6-0,75	44	63	72	74	76	73	66	55
71-6-1	45	65	73	75	77	74	67	56
71-6-1,5	46	66	71	76	78	75	68	57
80-4-4	56	76	84	89	91	88	81	74
80-4-5,5	56	76	84	89	91	88	81	74
80-6-1,5	49	66	74	79	81	78	71	60
80-6-2	50	67	75	80	82	79	72	61
80-6-3	51	68	76	81	83	80	73	62
90-4-5,5	60	81	88	93	96	92	85	74
90-4-7,5	59	80	87	92	95	91	84	73
90-4-10	58	79	86	91	94	90	83	72
90-6-2	49	70	77	82	85	81	74	63
90-6-3	56	70	77	82	85	81	74	63
90-6-4	57	72	79	84	87	83	76	65
100-4-7,5	64	84	92	97	99	96	89	78
100-4-10	62	82	90	95	97	94	87	76
100-4-15	61	81	89	94	96	93	86	75
100-4-20	63	83	91	96	98	95	88	77
100-6-3	61	72	80	85	87	84	77	66
100-6-4	64	72	80	85	87	84	77	66
100-6-5,5	64	73	81	86	88	85	78	67
125-4/3-25	73	79	91	101	101	97	89	85
125-4/3-30	74	80	92	102	102	98	90	86
125-4/3-40	75	81	93	103	103	99	91	87
125-4/6-25	68	76	92	99	101	96	90	86
125-4/6-30	68	76	92	99	101	96	90	86
125-4/6-40	70	78	94	101	103	98	92	88
125-4/6-50	71	79	95	102	104	99	93	89
125-4/9-25	66	74	91	97	98	93	88	84
125-4/9-30	67	75	92	98	99	94	89	85
125-4/9-40	69	77	94	100	101	96	91	87
125-4/9-50	71	79	96	102	103	98	93	89
125-6/3-4	66	74	86	90	88	83	74	70
125-6/3-5,5	66	74	86	90	88	83	74	70
125-6/3-7,5	67	75	87	91	89	84	75	71
125-6/3-10	69	77	89	93	91	86	77	73
125-6/3-15	70	78	90	94	92	87	78	74
125-6/3-20	71	79	91	95	93	88	79	75
125-6/6-5,5	60	69	82	85	86	83	72	68
125-6/6-7,5	60	69	82	85	86	83	72	68
125-6/6-10	62	71	84	87	88	85	74	70
125-6/6-15	64	73	86	89	90	87	76	72
125-6/6-20	65	74	87	90	91	88	77	73
125-6/9-10	58	68	83	87	86	85	74	70
125-6/9-15	61	71	86	90	89	88	77	73
125-6/9-20	64	74	89	93	92	91	80	76

Values taken during discharge with maximum flow rate

Model	63	125	250	500	1000	2000	4000	8000
40-4-0,75	31	52	59	64	67	63	56	45
40-6-0,75	21	42	49	54	57	53	46	35
45-4-0,75	35	56	63	68	71	67	60	49
45-6-0,75	23	44	51	56	59	55	48	37
50-4-1	39	59	67	72	74	71	64	53
50-6-0,75	28	48	56	61	63	60	53	42
56-4-1	43	63	71	76	78	75	68	57
56-4-1,5	44	64	72	77	79	76	69	58
56-4-2	45	65	73	78	80	77	70	59
56-6-0,75	33	53	61	66	68	65	58	47
63-4-1,5	44	64	72	77	79	76	69	60
63-4-2	47	64	72	77	79	76	69	61
63-4-3	48	66	74	79	81	78	73	62
63-4-4	49	67	75	80	82	79	74	63
63-6-0,75	38	56	64	69	71	68	61	52
63-6-1	39	58	66	71	73	70	63	53
71-4-2	49	69	77	82	84	81	74	65
71-4-3	53	68	76	81	83	80	73	67
71-4-4	54	69	77	82	84	81	74	68
71-6-0,75	40	60	68	71	73	70	63	52
71-6-1	41	61	69	71	73	70	63	52
71-6-1,5	42	62	67	72	74	71	64	53
80-4-4	52	72	80	85	87	84	77	69
80-4-5,5	52	72	80	85	87	84	77	70
80-6-1,5	45	62	70	75	77	74	67	56
80-6-2	46	63	71	76	78	75	68	57
80-6-3	47	64	72	77	79	76	69	58
90-4-5,5	56	77	84	89	92	88	81	70
90-4-7,5	55	76	83	88	91	87	80	69
90-4-10	54	75	82	87	90	86	79	68
90-6-2	45	66	73	78	81	77	70	59
90-6-3	52	66	73	78	81	77	70	59
90-6-4	53	68	75	80	83	79	72	61
100-4-7,5	60	80	88	93	95	92	85	74
100-4-10	58	78	86	91	93	90	83	72
100-4-15	57	77	85	90	92	89	82	71
100-4-20	59	79	87	92	94	91	84	73
100-6-3	58	69	77	82	84	81	74	63
100-6-4	59	67	75	80	82	79	72	61
100-6-5,5	60	69	77	82	84	81	74	63
125-4/3-25	68	74	86	96	96	92	84	80
125-4/3-30	69	75	87	97	97	93	85	81
125-4/3-40	70	76	88	98	98	94	86	82
125-4/6-25	63	71	87	94	96	91	85	81
125-4/6-30	63	71	87	94	96	91	85	81
125-4/6-40	65	73	89	96	98	93	87	83
125-4/6-50	66	74	90	97	99	94	88	84
125-4/9-25	61	69	86	92	93	88	83	79
125-4/9-30	62	70	87	93	94	89	84	80
125-4/9-40	64	72	89	95	96	91	86	82
125-4/9-50	66	74	91	97	98	93	88	84
125-6/3-4	61	69	81	85	83	78	69	65
125-6/3-5,5	62	70	82	86	84	79	70	66
125-6/3-7,5	63	71	83	87	85	80	71	67
125-6/3-10	65	73	85	89	87	82	73	69
125-6/3-15	66	74	86	90	88	83	74	70
125-6/3-20	67	75	87	91	89	84	75	71
125-6/6-5,5	56	65	78	81	82	79	68	64
125-6/6-7,5	56	65	78	81	82	79	68	64
125-6/6-10	58	67	80	83	84	81	70	66
125-6/6-15	60	69	82	85	86	83	72	68
125-6/6-20	61	70	83	86	87	84	73	69
125-6/9-10	54	64	79	83	82	81	70	66
125-6/9-15	57	67	82	86	85	84	73	69
125-6/9-20	60	70	85	89	88	87	76	72

## Dimensions mm

Model	A	B	C	D	ØF	G	H	ØI
HTMV-40	628	349	244	35	519	630	530	12
HTMV-45	642	363	244	35	569	710	590	12
HTMV-50	679	400	244	35	626	900	750	12
HTMV-56	710	426	244	40	686	900	750	14
HTMV-63	747	463	244	40	753	1000	850	14
HTMV-71	830	498	292	40	833	1000	850	14
HTMV-80	887	545	292	50	923	1150	1000	14
HTMV-90	989	601	338	50	1031	1150	1000	14
HTMV-100	1136	648	438	50	1128	1250	1100	14
HTMV-125	1313	775	488	50	1376	1425	1275	17

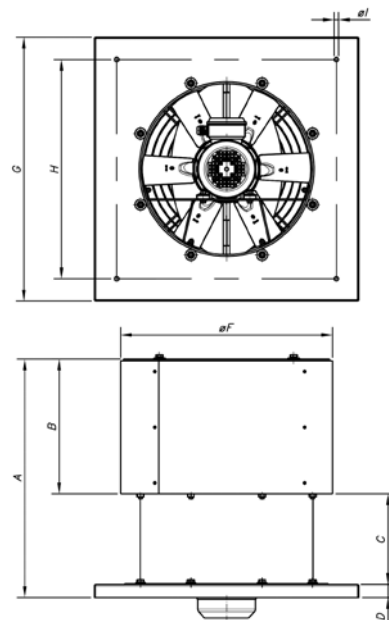

**Characteristic curves**

Q= Flow rate in m<sup>3</sup>/h, m<sup>3</sup>/s and cfm.

Pe= Static pressure in mm H<sub>2</sub>O, Pa and inwg.

40-4T

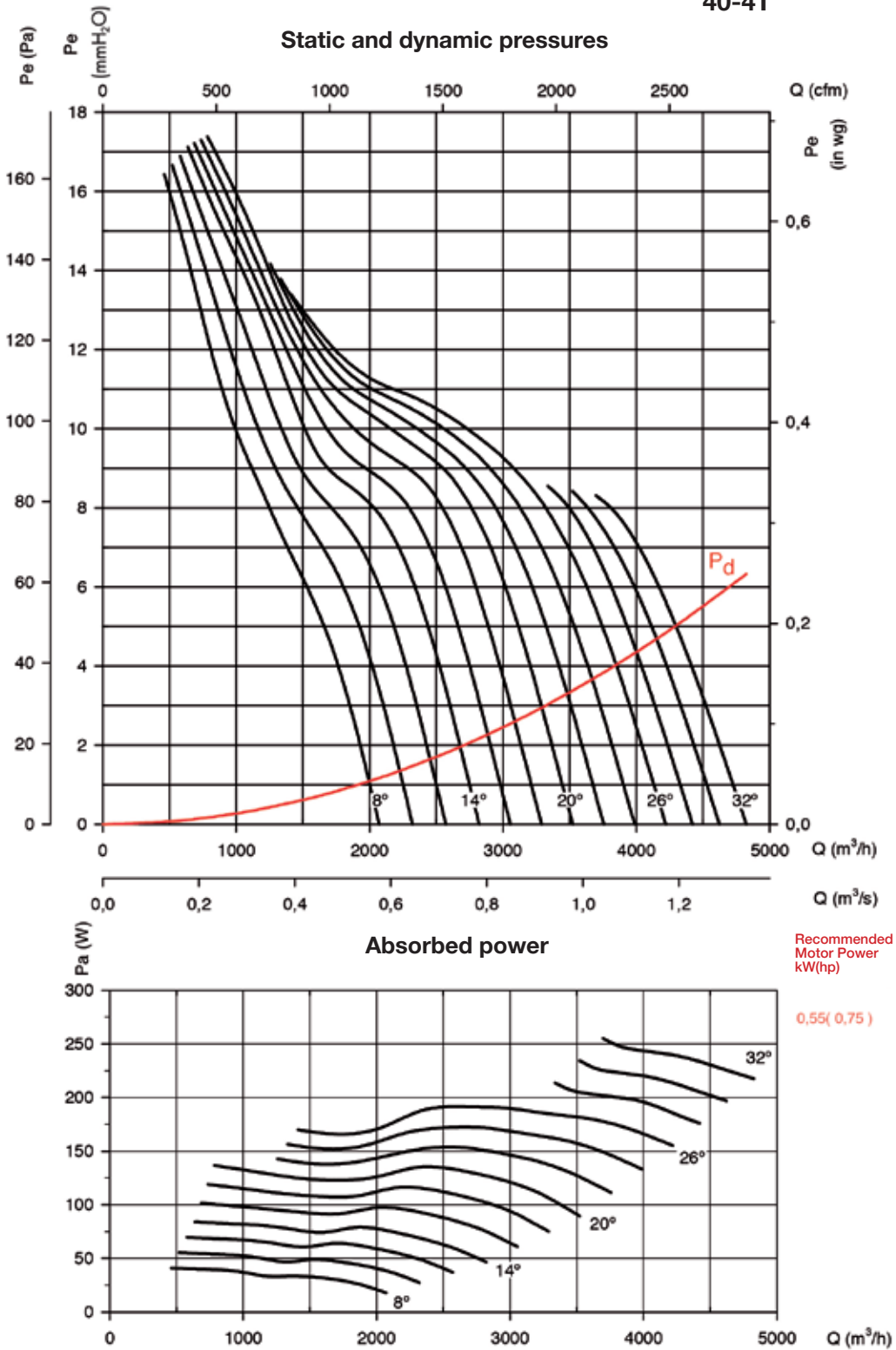

**Characteristic curves**

Q= Flow rate in m<sup>3</sup>/h, m<sup>3</sup>/s and cfm.

Pe= Static pressure in mm H<sub>2</sub>O, Pa and inwg.

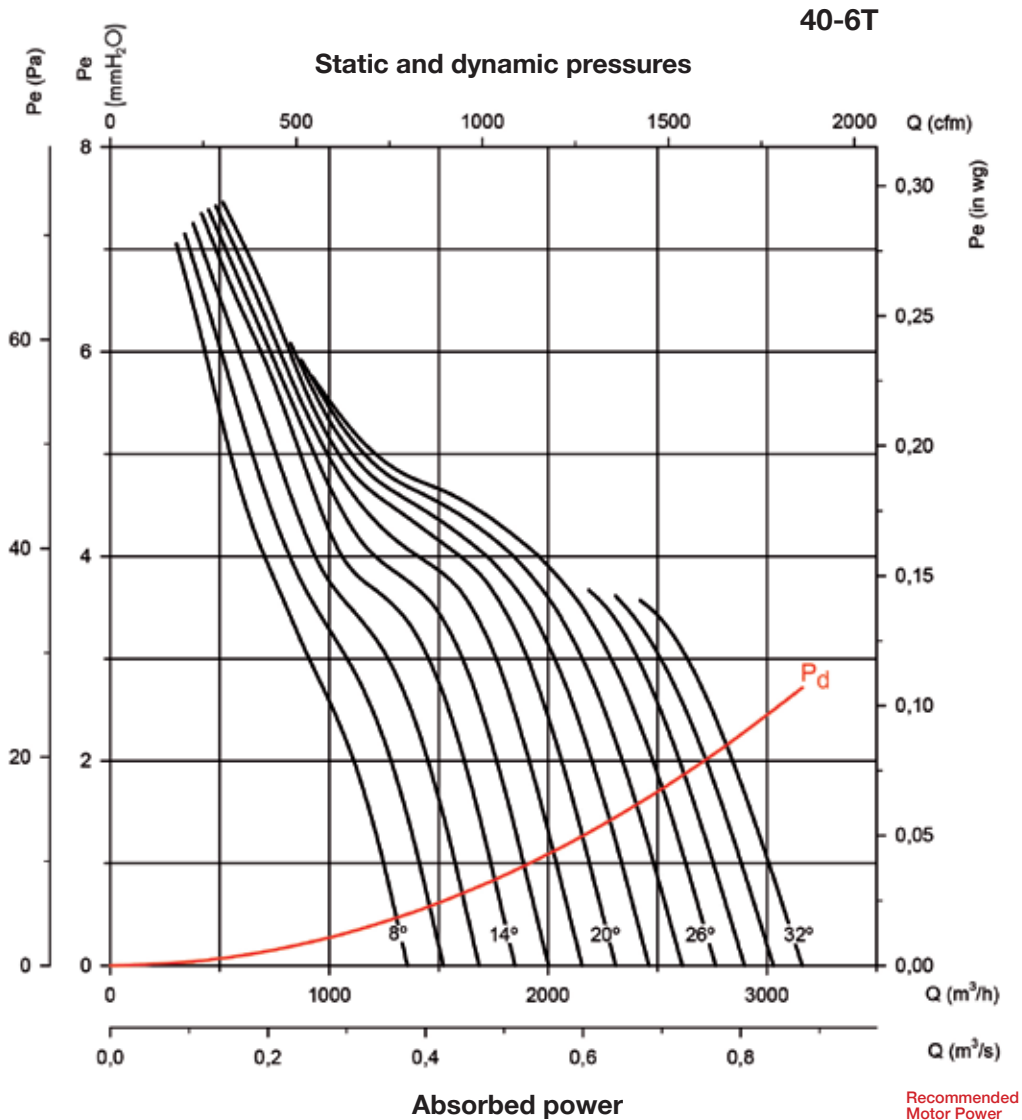

Recommended Motor Power kW(hp)

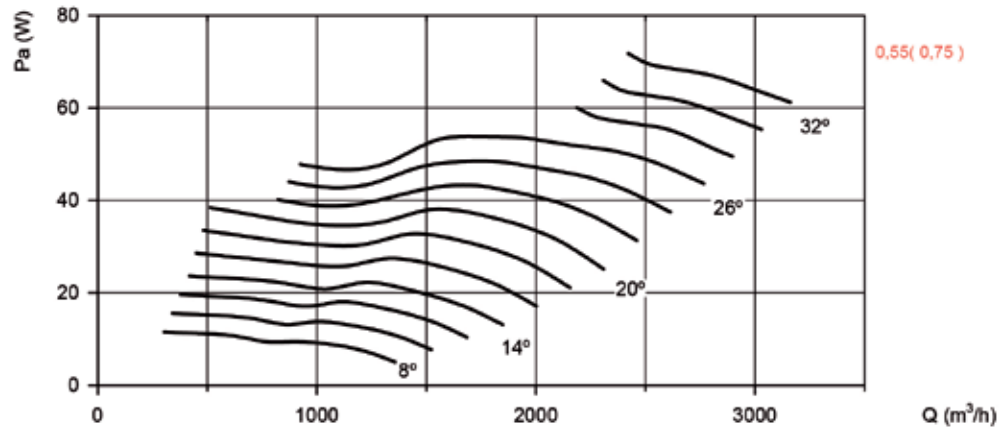

**Characteristic curves**

Q= Flow rate in m<sup>3</sup>/h, m<sup>3</sup>/s and cfm.

Pe= Static pressure in mm H<sub>2</sub>O, Pa and inwg.

45-4T

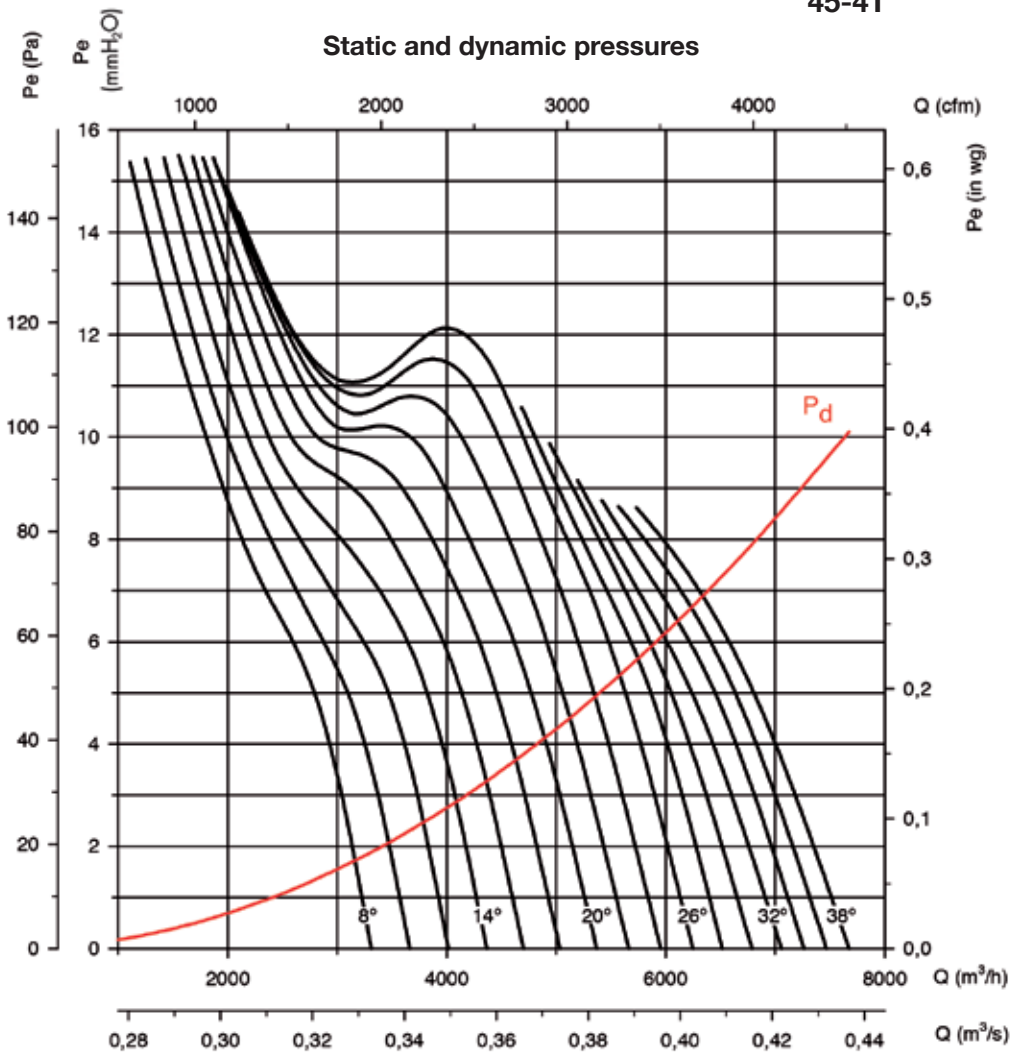

Absorbed power

Recommended Motor Power kW(hp)

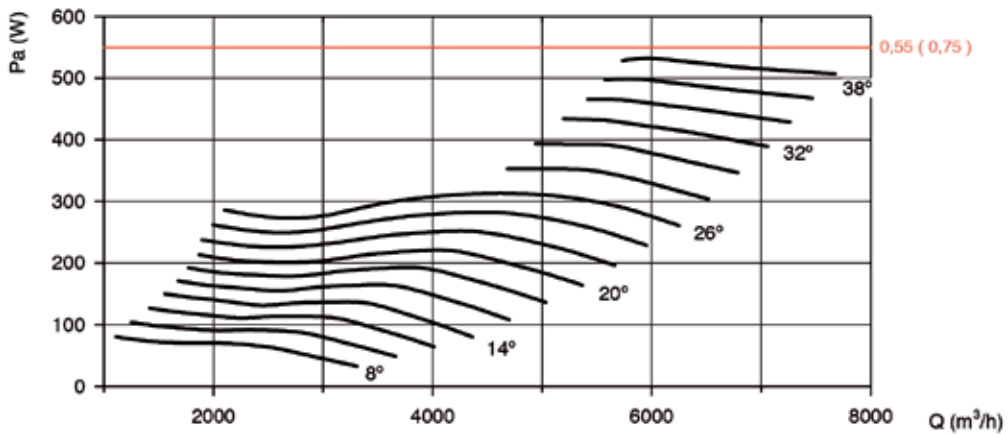

**Characteristic curves**

Q= Flow rate in m<sup>3</sup>/h, m<sup>3</sup>/s and cfm.

Pe= Static pressure in mm H<sub>2</sub>O, Pa and inwg.

45-6T

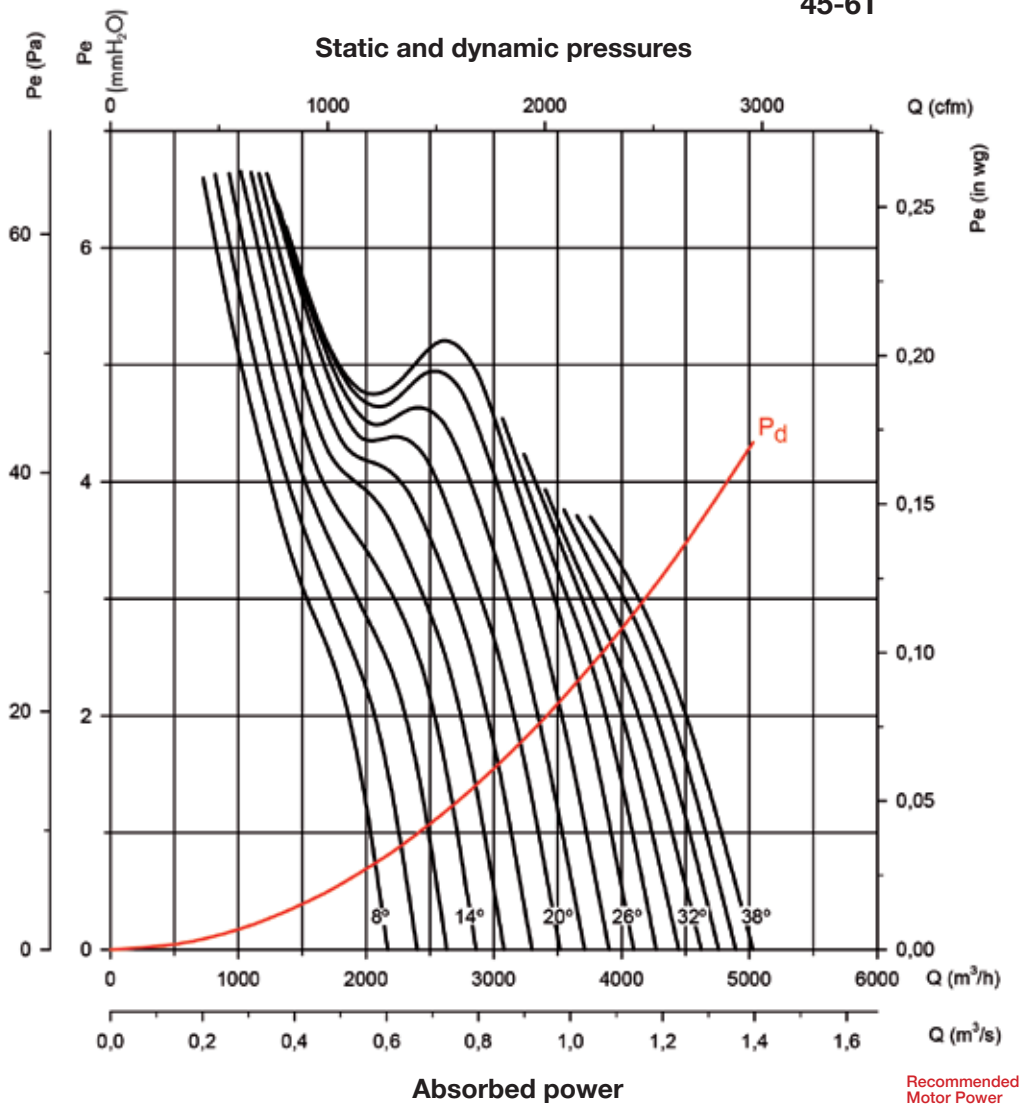

Recommended Motor Power kW(hp)

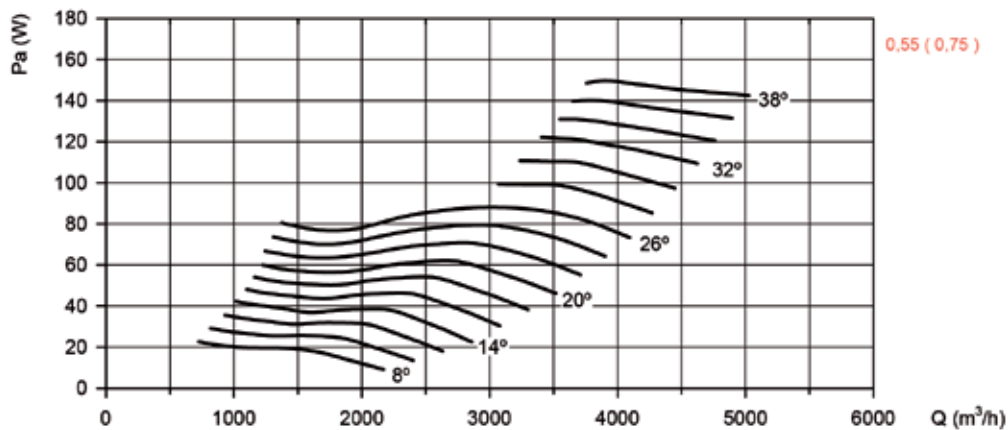

**Characteristic curves**

Q= Flow rate in m<sup>3</sup>/h, m<sup>3</sup>/s and cfm.

Pe= Static pressure in mm H<sub>2</sub>O, Pa and inwg.

50-4T

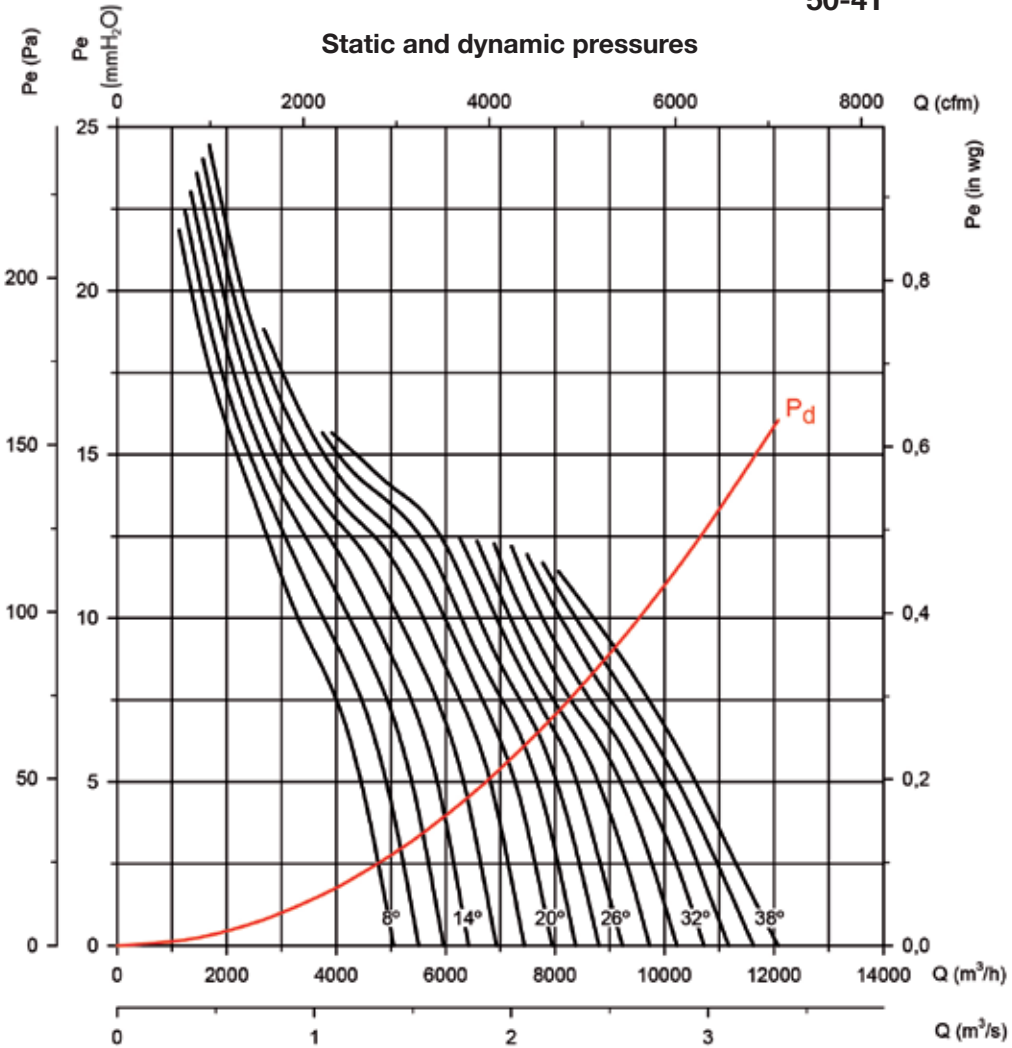

Absorbed power

Recommended Motor Power kW(hp)

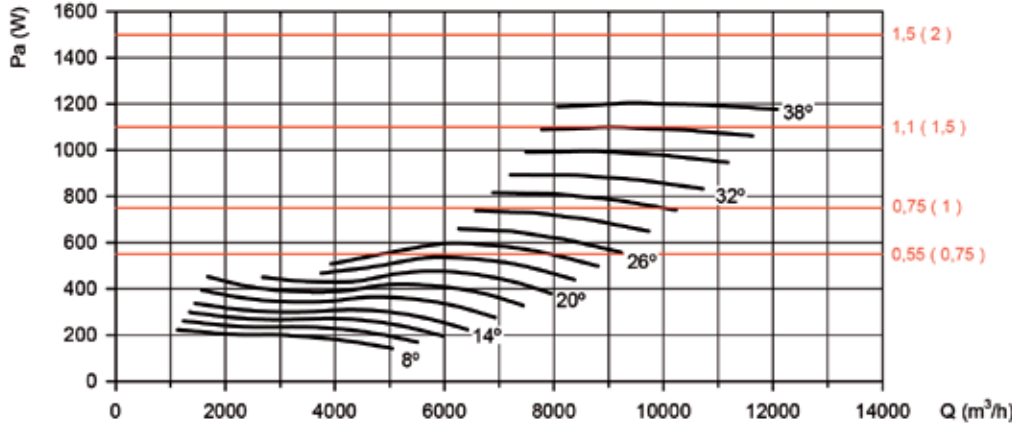

**Characteristic curves**

Q= Flow rate in m<sup>3</sup>/h, m<sup>3</sup>/s and cfm.

Pe= Static pressure in mm H<sub>2</sub>O, Pa and inwg.

50-6T

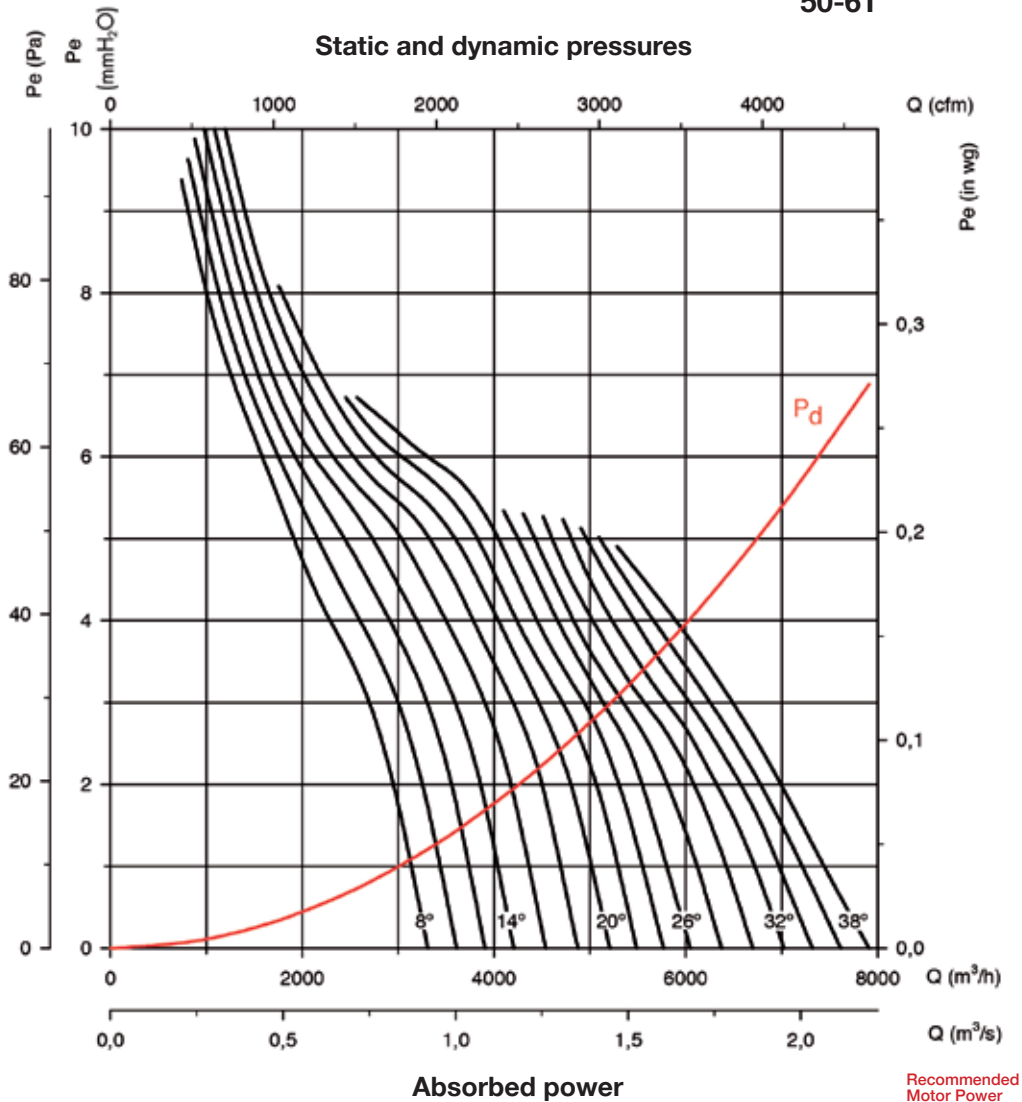

Recommended  
Motor Power  
kW(hp)

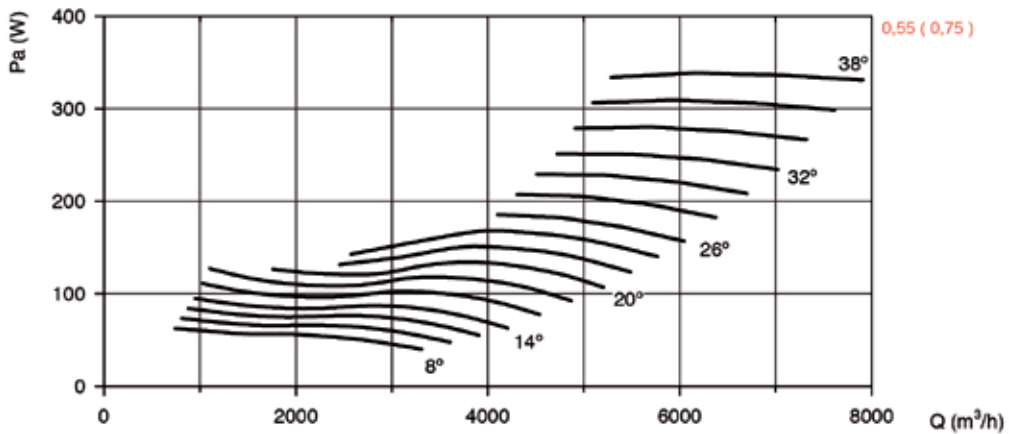



**Characteristic curves**

Q= Flow rate in m<sup>3</sup>/h, m<sup>3</sup>/s and cfm.

Pe= Static pressure in mm H<sub>2</sub>O, Pa and inwg.

56-4T

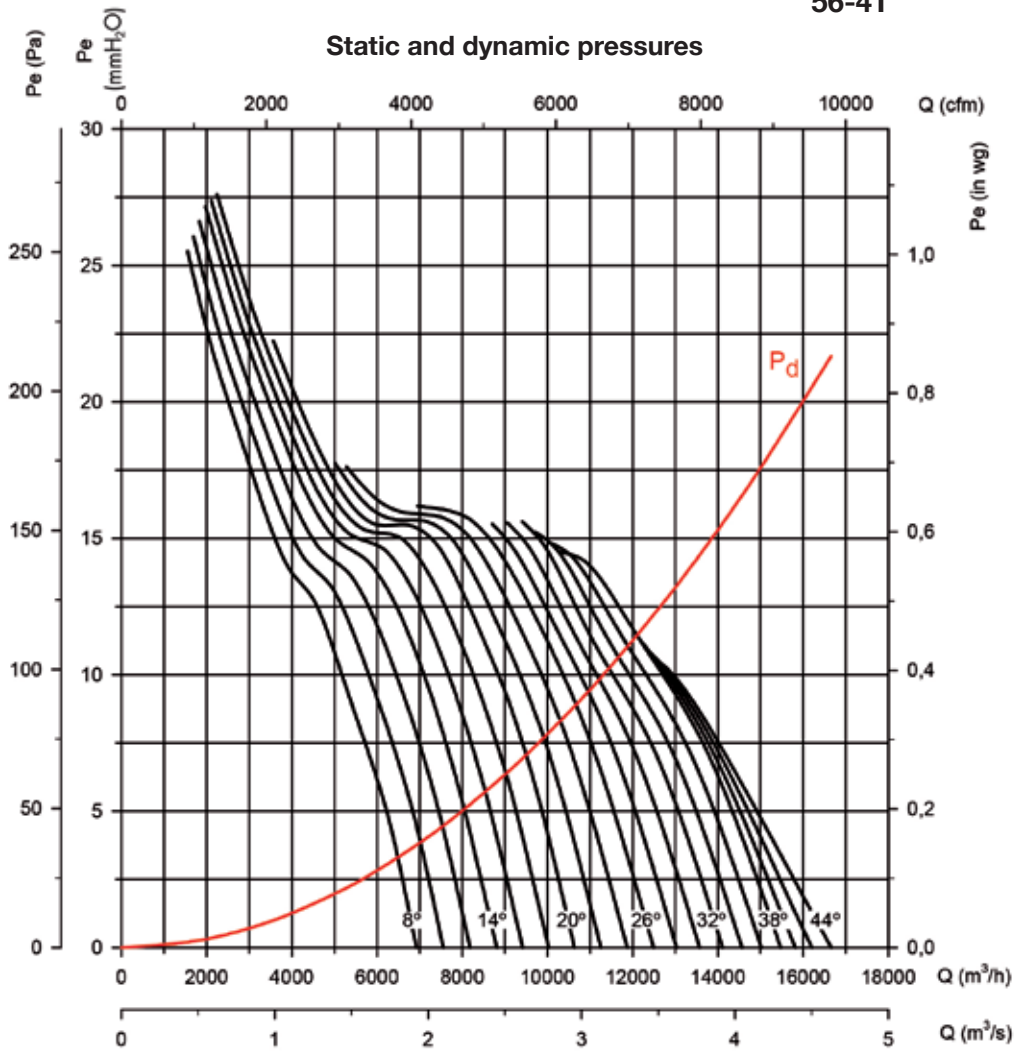

Absorbed power

Recommended Motor Power kW(hp)

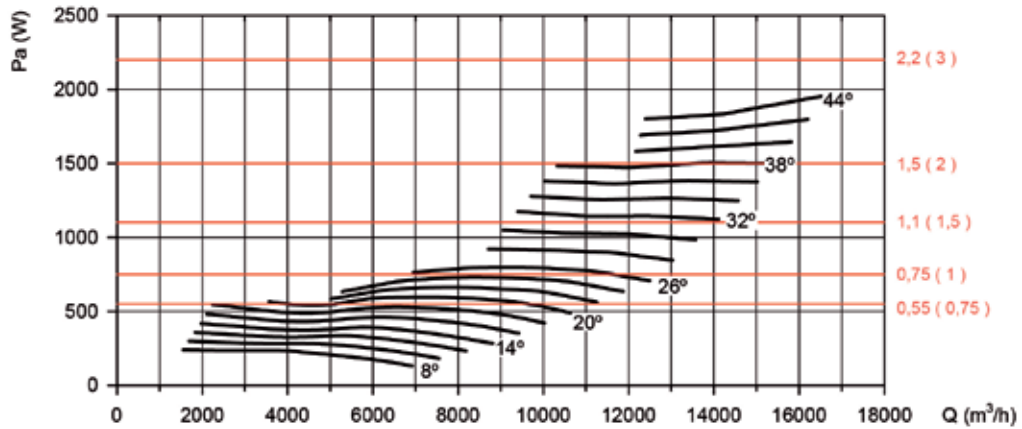

**Characteristic curves**

Q= Flow rate in m<sup>3</sup>/h, m<sup>3</sup>/s and cfm.

Pe= Static pressure in mm H<sub>2</sub>O, Pa and inwg.

56-6T

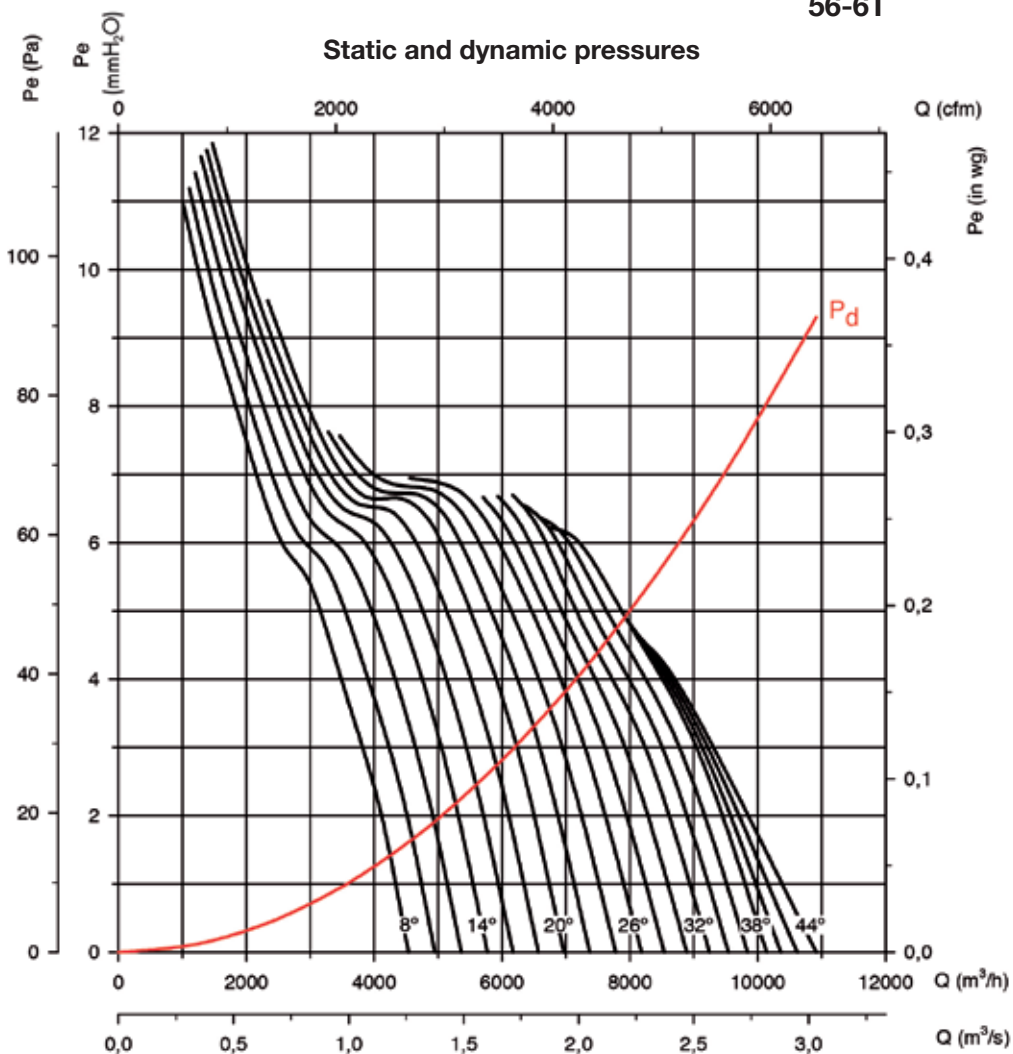

Absorbed power

Recommended Motor Power kW(hp)

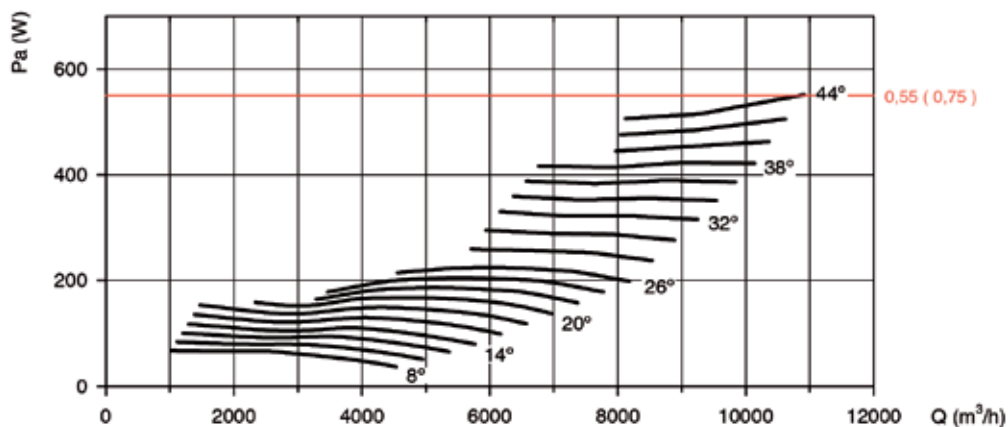

**Characteristic curves**

Q= Flow rate in m<sup>3</sup>/h, m<sup>3</sup>/s and cfm.

Pe= Static pressure in mm H<sub>2</sub>O, Pa and inwg.

63-4T

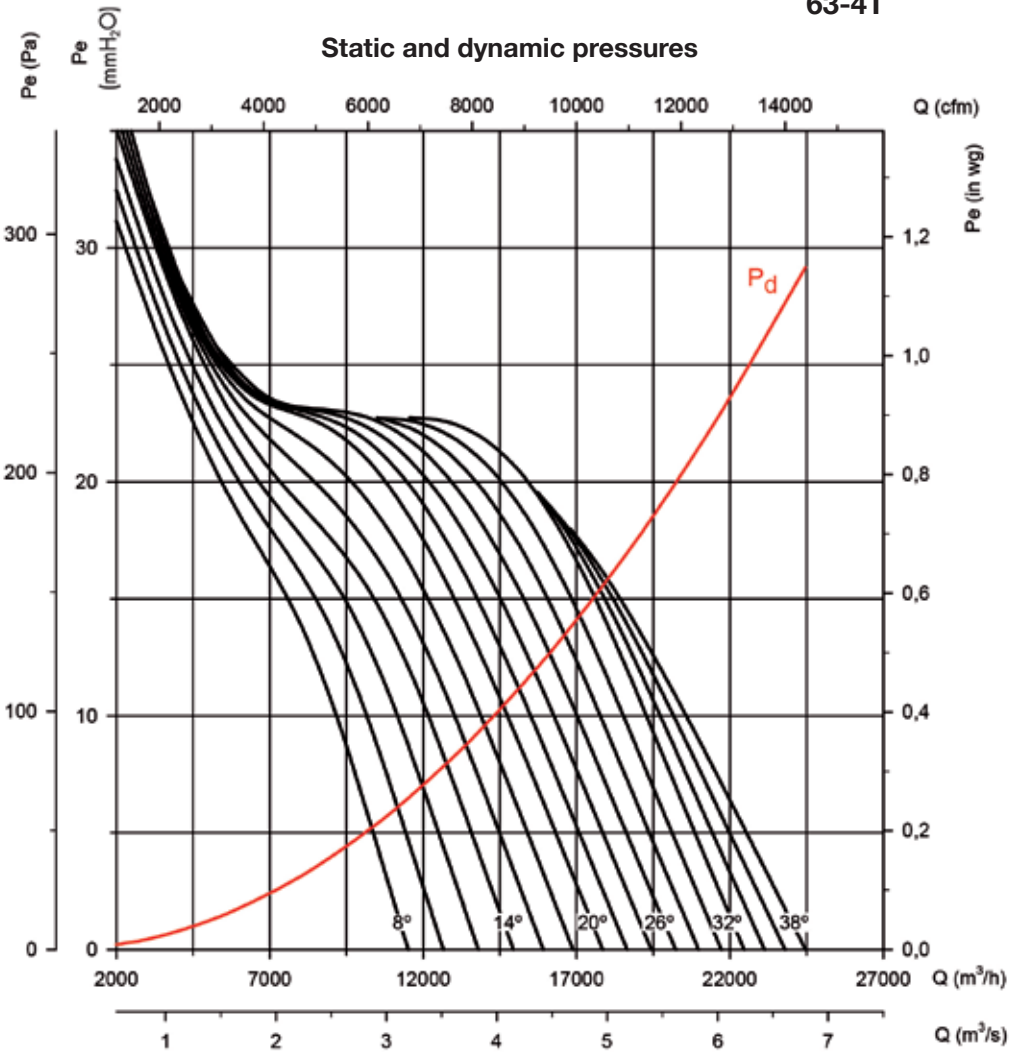

Absorbed power

Recommended Motor Power kW(hp)

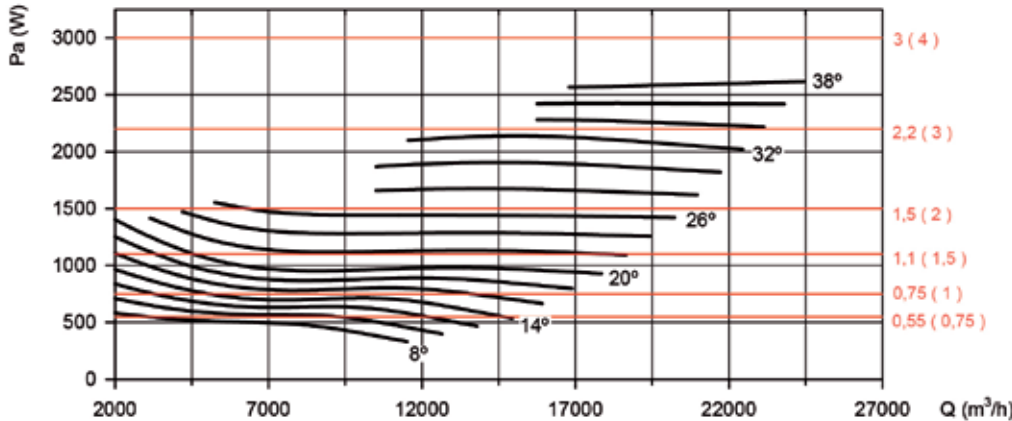

**Characteristic curves**

Q= Flow rate in m<sup>3</sup>/h, m<sup>3</sup>/s and cfm.

Pe= Static pressure in mm H<sub>2</sub>O, Pa and inwg.

63-6T

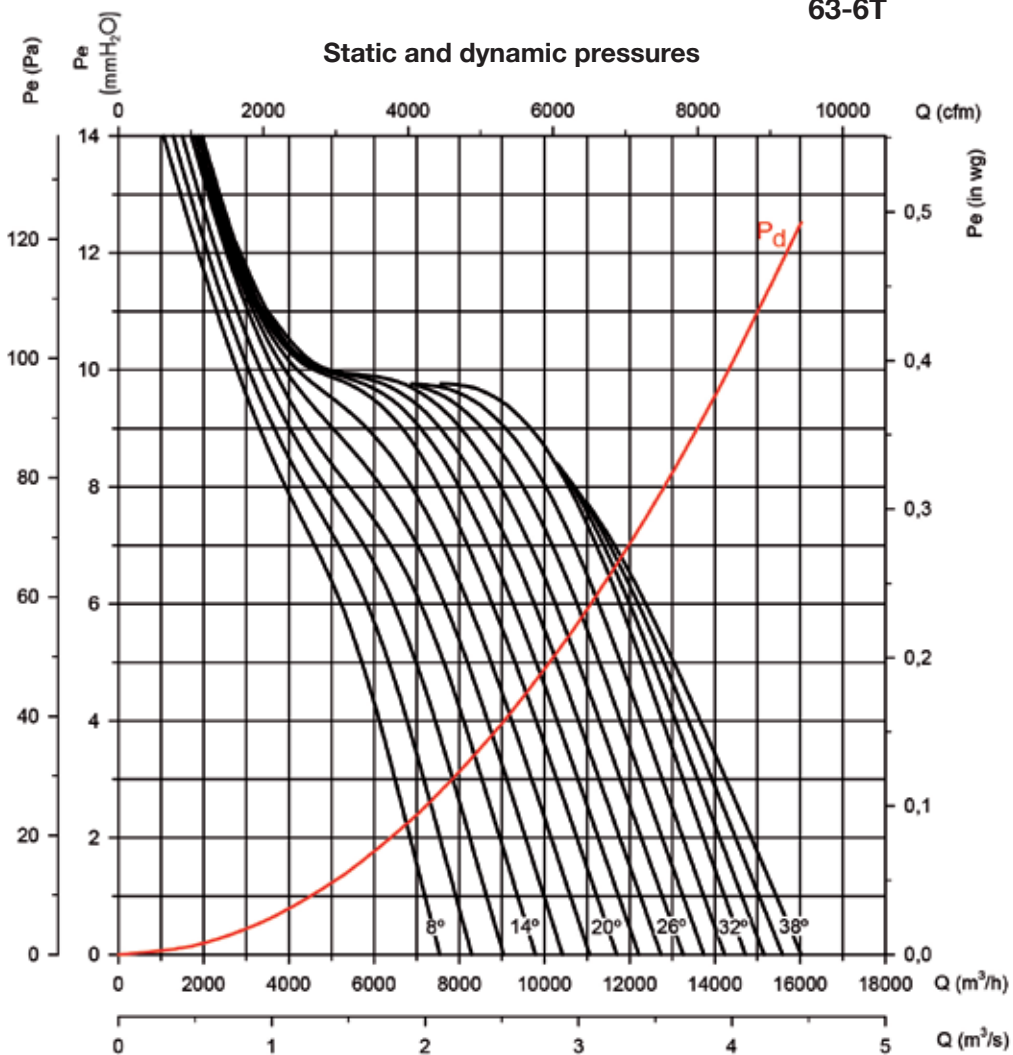

Absorbed power

Recommended Motor Power kW(hp)

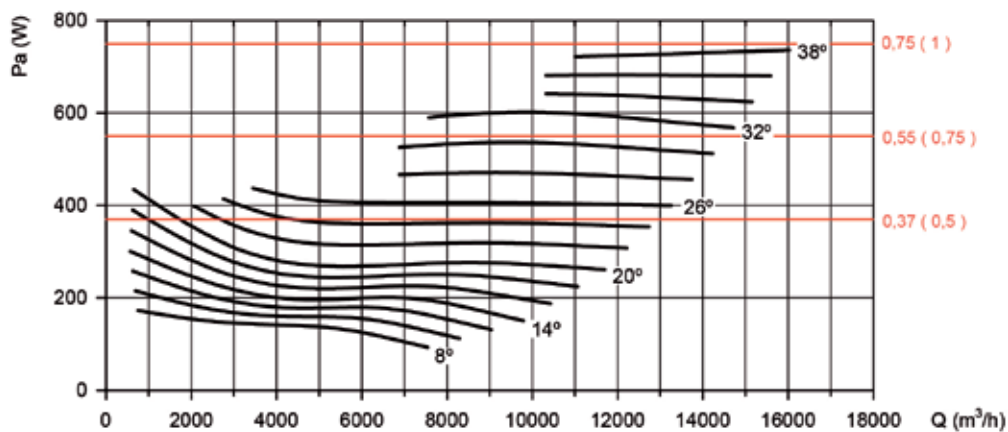

**Characteristic curves**

Q= Flow rate in m<sup>3</sup>/h, m<sup>3</sup>/s and cfm.

Pe= Static pressure in mm H<sub>2</sub>O, Pa and inwg.

71-4T

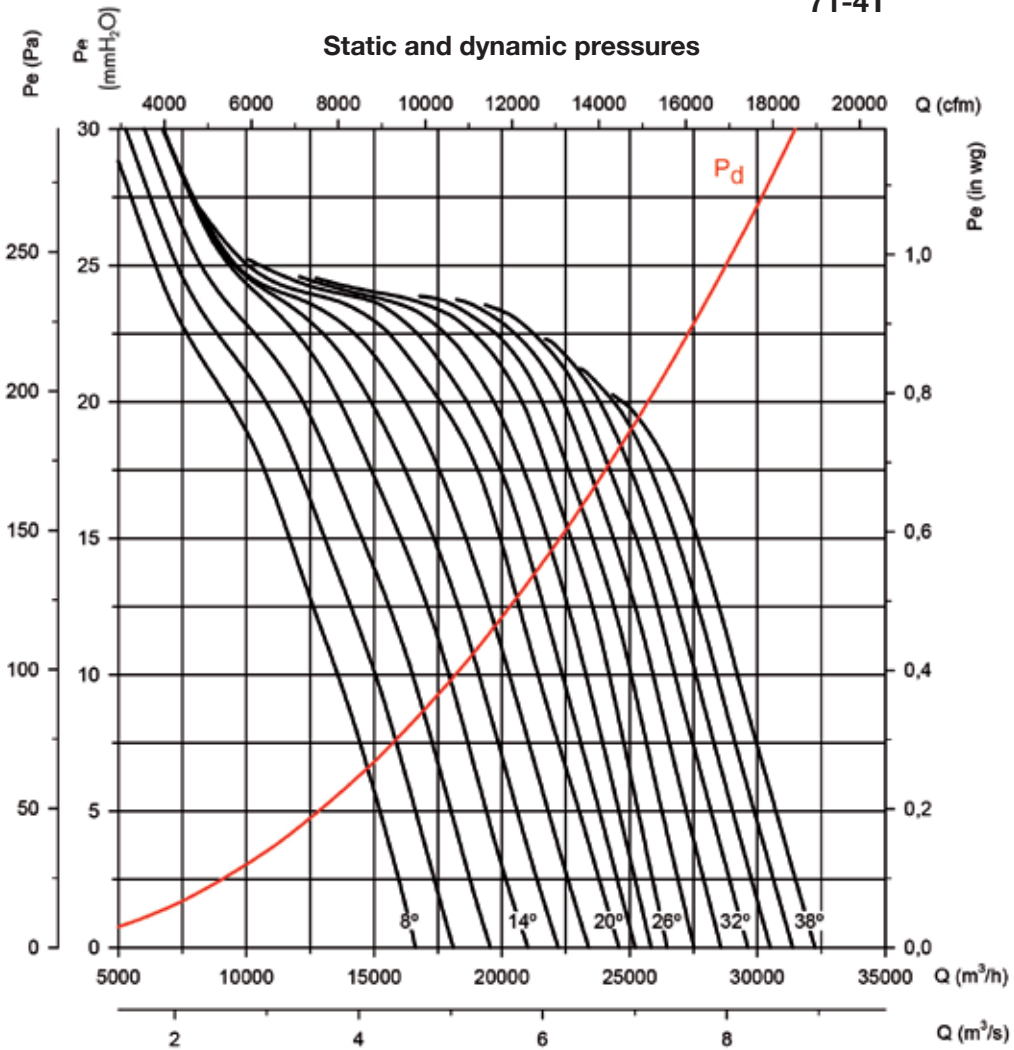

Absorbed power

Recommended Motor Power kW(hp)

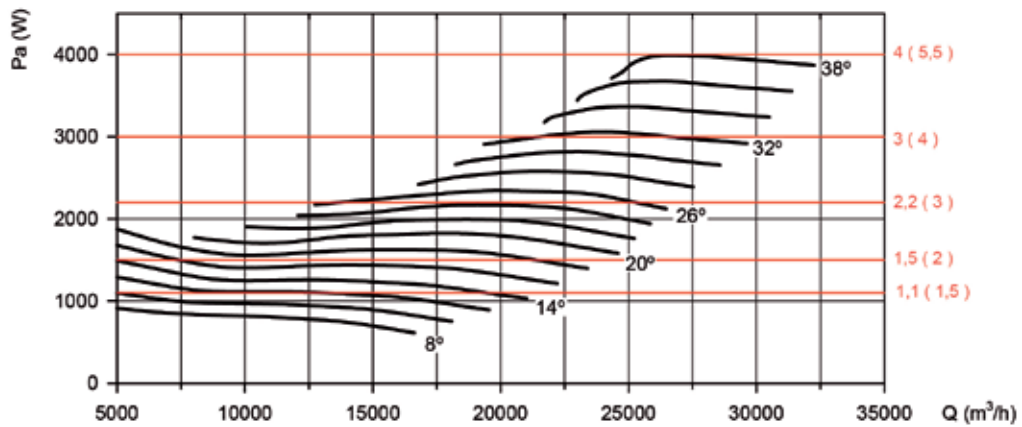

**Characteristic curves**

Q= Flow rate in m<sup>3</sup>/h, m<sup>3</sup>/s and cfm.

Pe= Static pressure in mm H<sub>2</sub>O, Pa and inwg.

71-6T

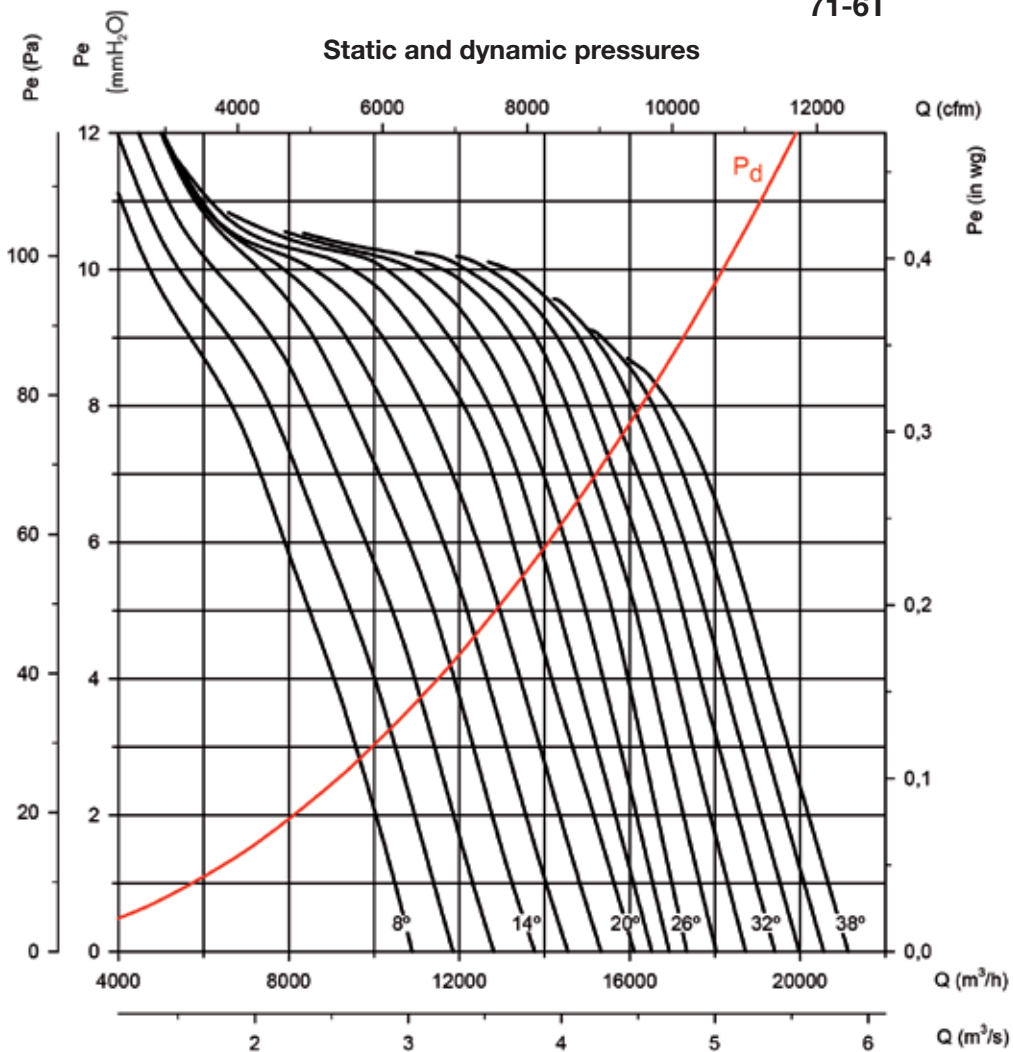

Absorbed power

Recommended Motor Power kW(hp)

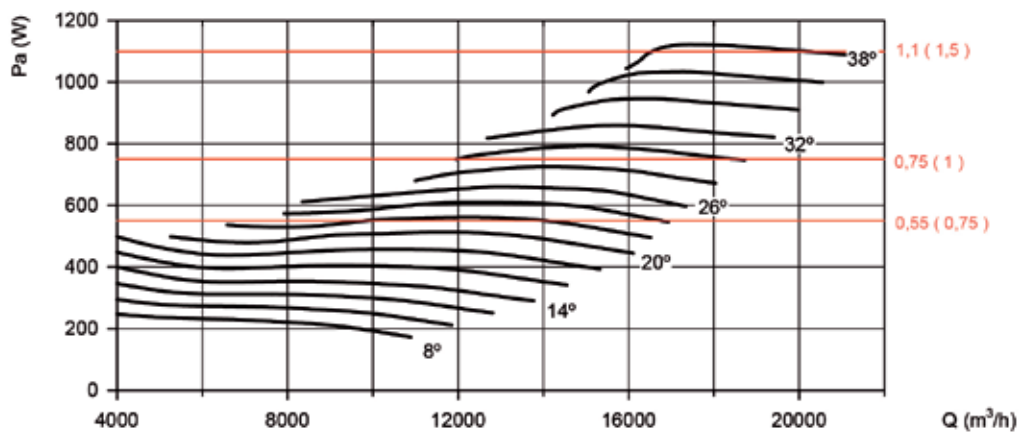

**Characteristic curves**

Q= Flow rate in m<sup>3</sup>/h, m<sup>3</sup>/s and cfm.

Pe= Static pressure in mm H<sub>2</sub>O, Pa and inwg.

80-4T

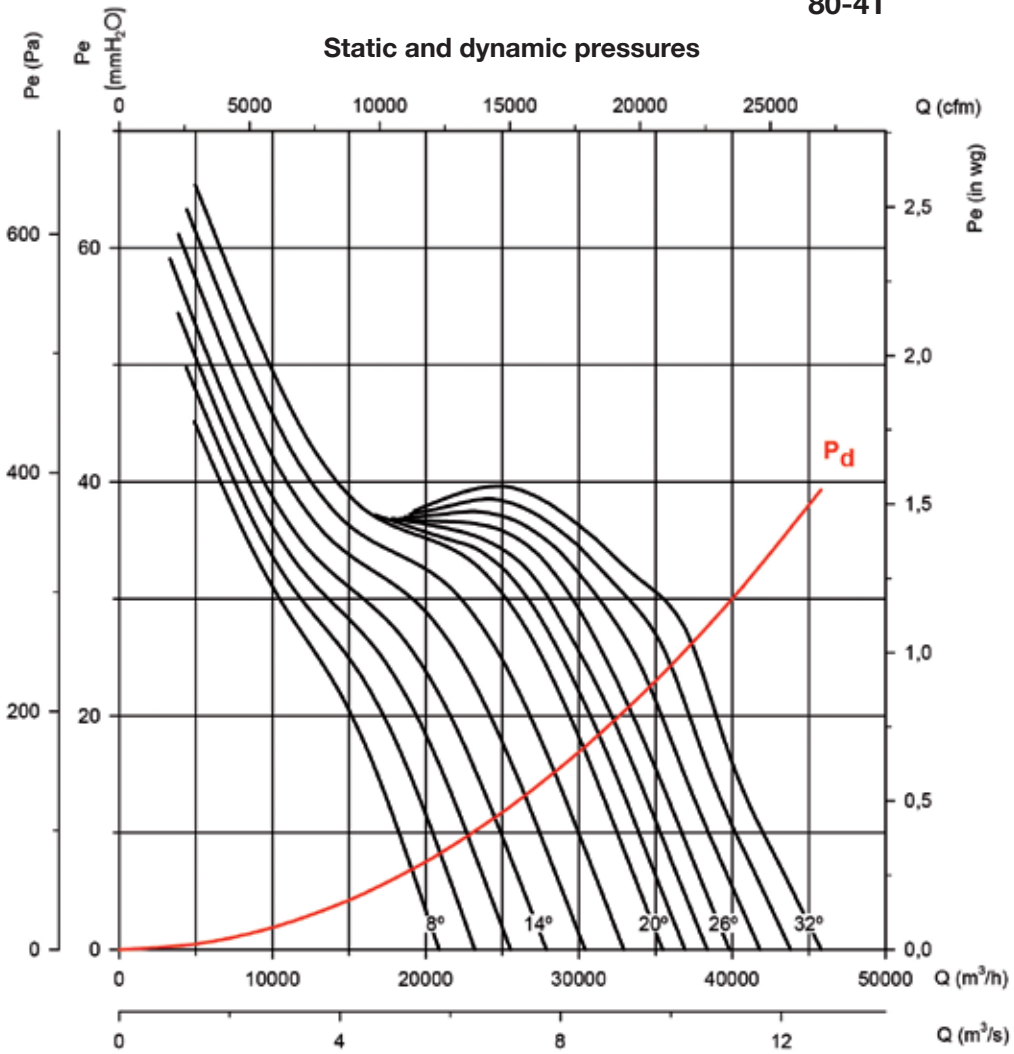

Absorbed power

Recommended Motor Power kW(hp)

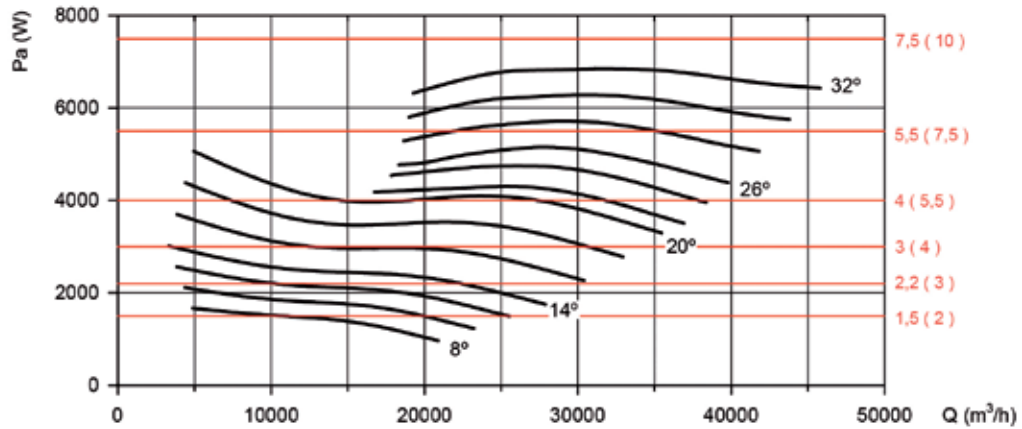

**Characteristic curves**

Q= Flow rate in m<sup>3</sup>/h, m<sup>3</sup>/s and cfm.

Pe= Static pressure in mm H<sub>2</sub>O, Pa and inwg.

80-6T

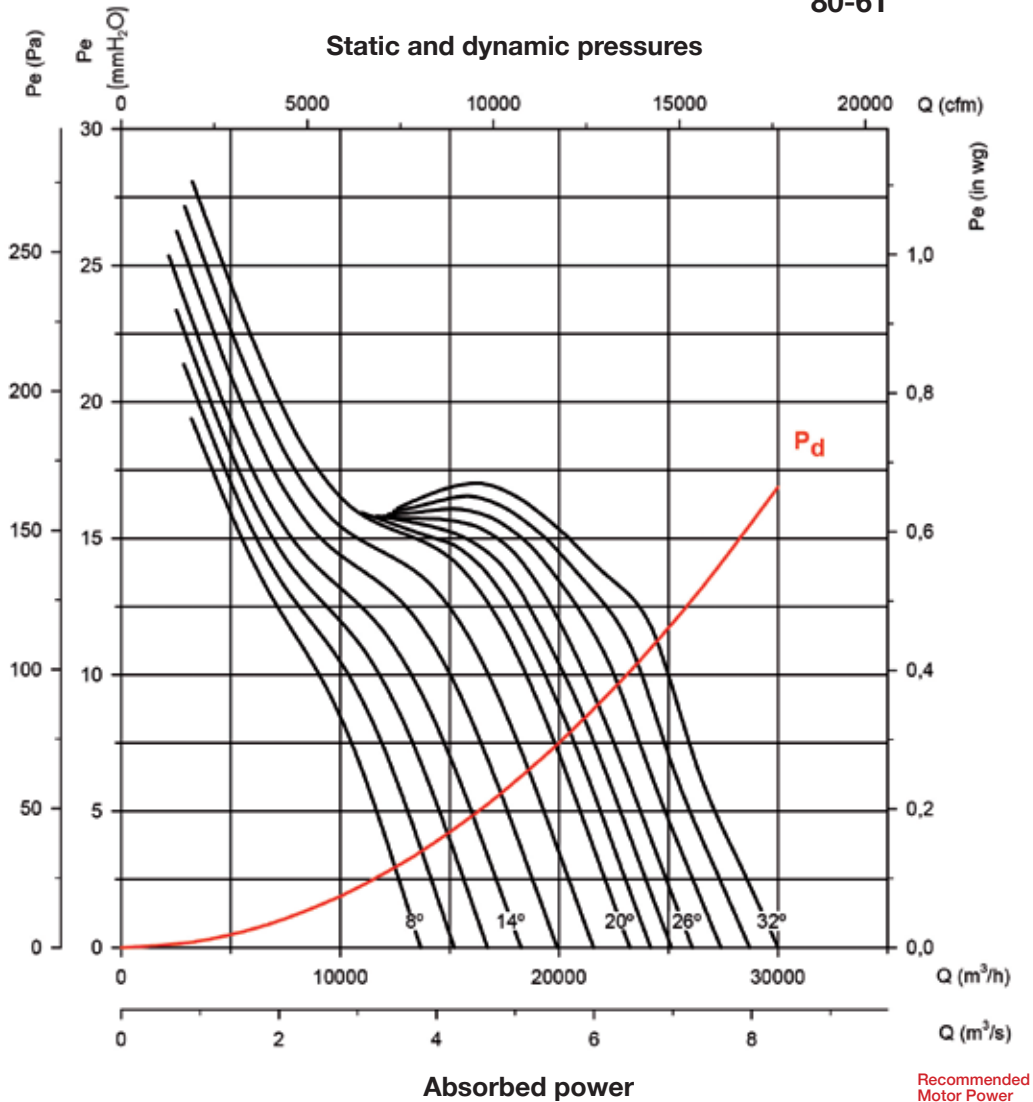

Recommended Motor Power kW(hp)

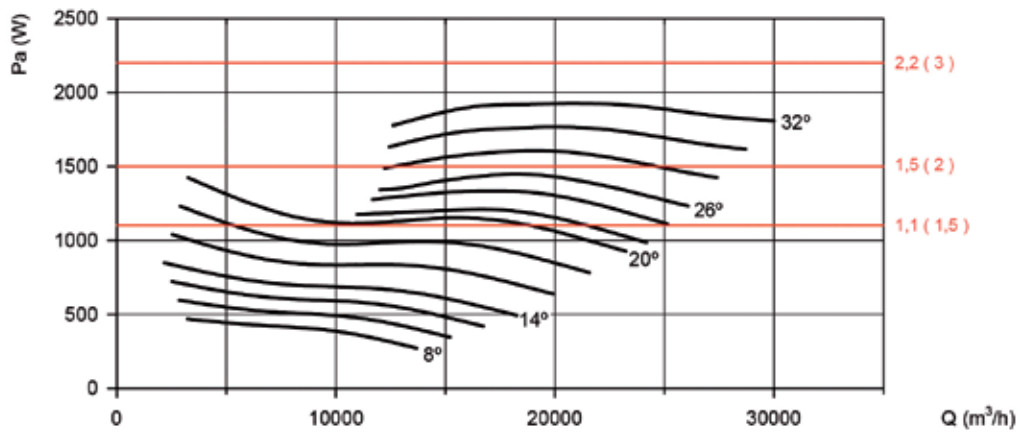



**Characteristic curves**

Q= Flow rate in m<sup>3</sup>/h, m<sup>3</sup>/s and cfm.

Pe= Static pressure in mm H<sub>2</sub>O, Pa and inwg.

90-4T

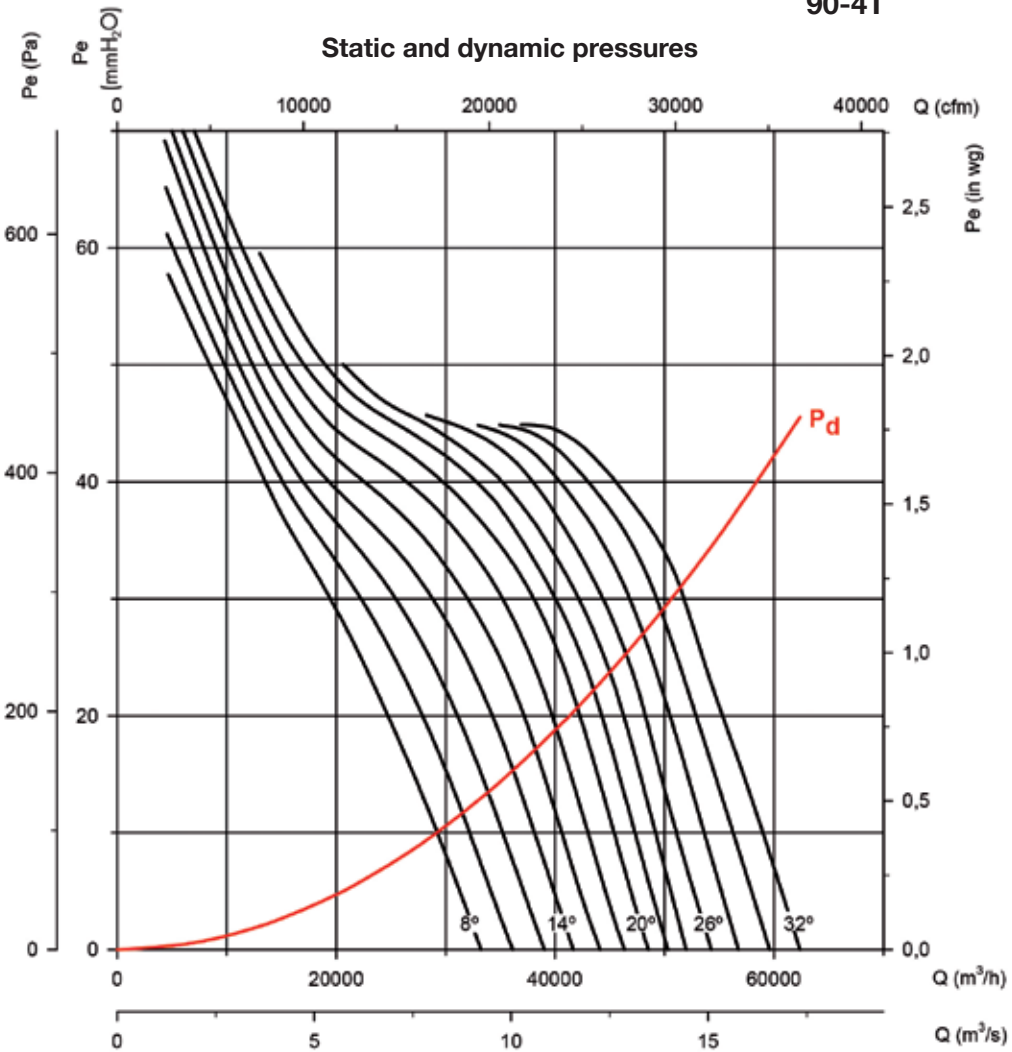

Absorbed power

Recommended Motor Power kW(hp)

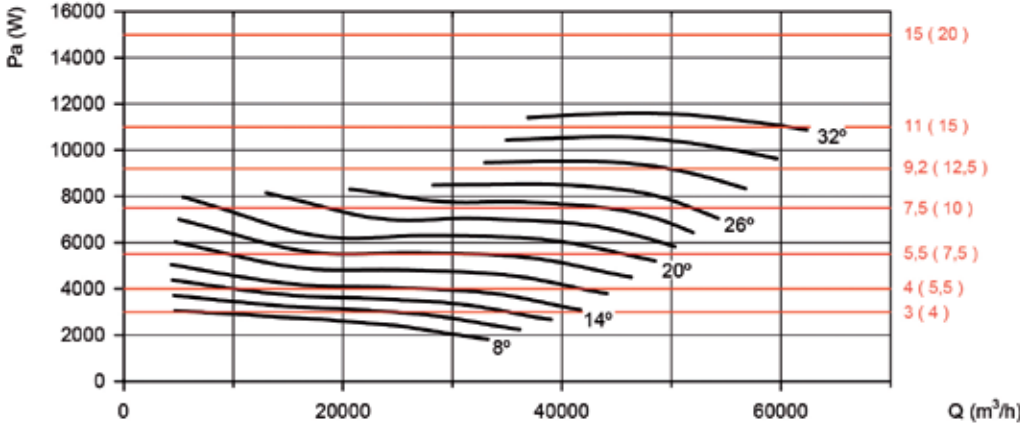

**Characteristic curves**

Q= Flow rate in m<sup>3</sup>/h, m<sup>3</sup>/s and cfm.

Pe= Static pressure in mm H<sub>2</sub>O, Pa and inwg.

90-6T

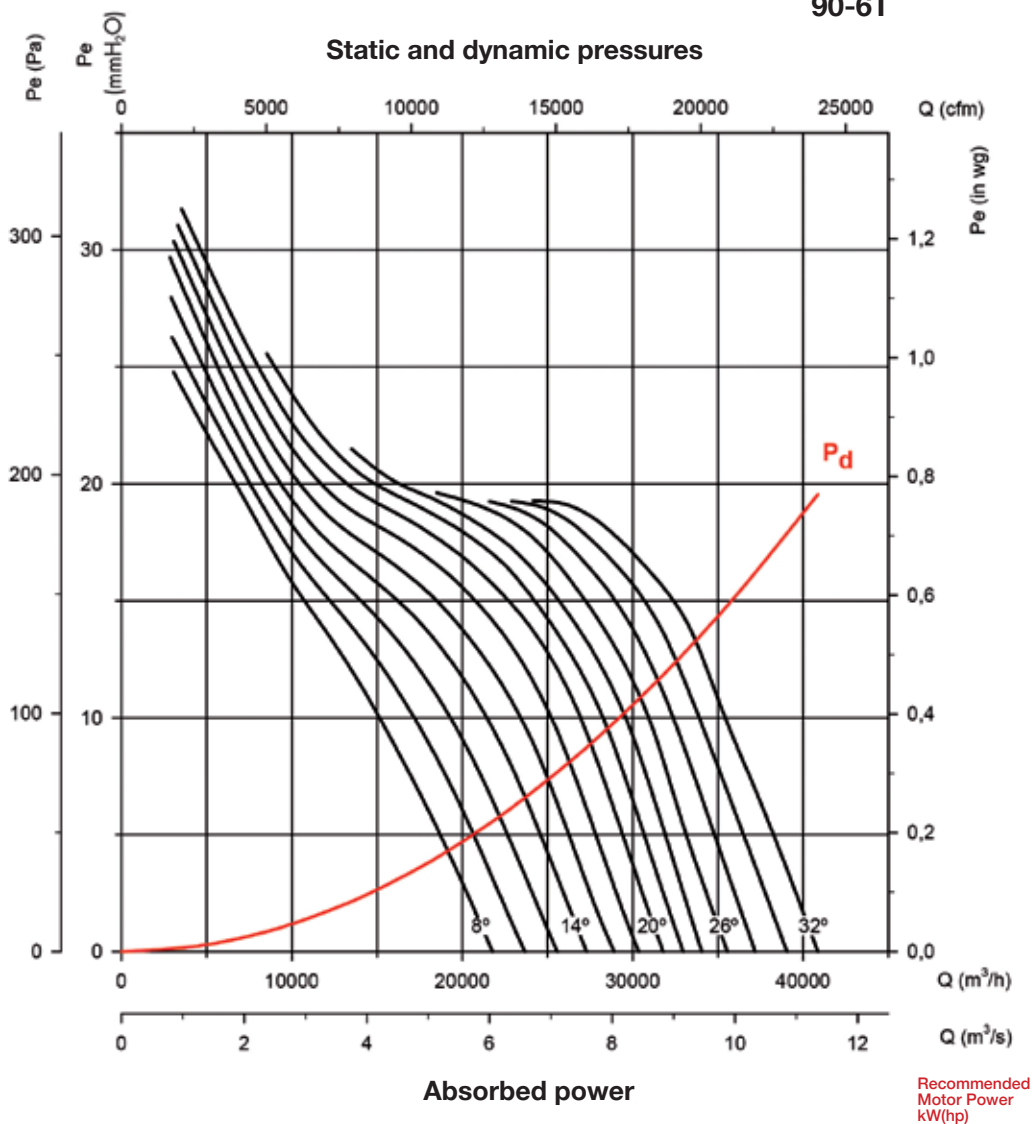

Recommended Motor Power kW(hp)

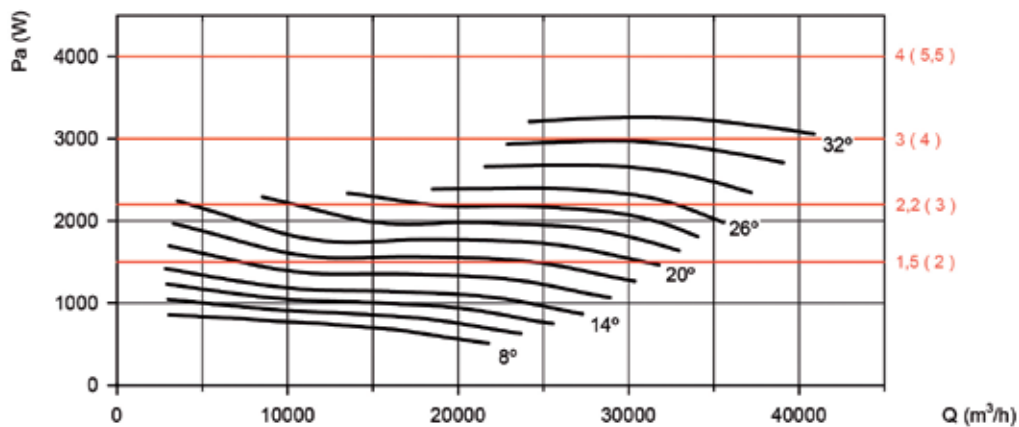

**Characteristic curves**

Q= Flow rate in m<sup>3</sup>/h, m<sup>3</sup>/s and cfm.

Pe= Static pressure in mm H<sub>2</sub>O, Pa and inwg.

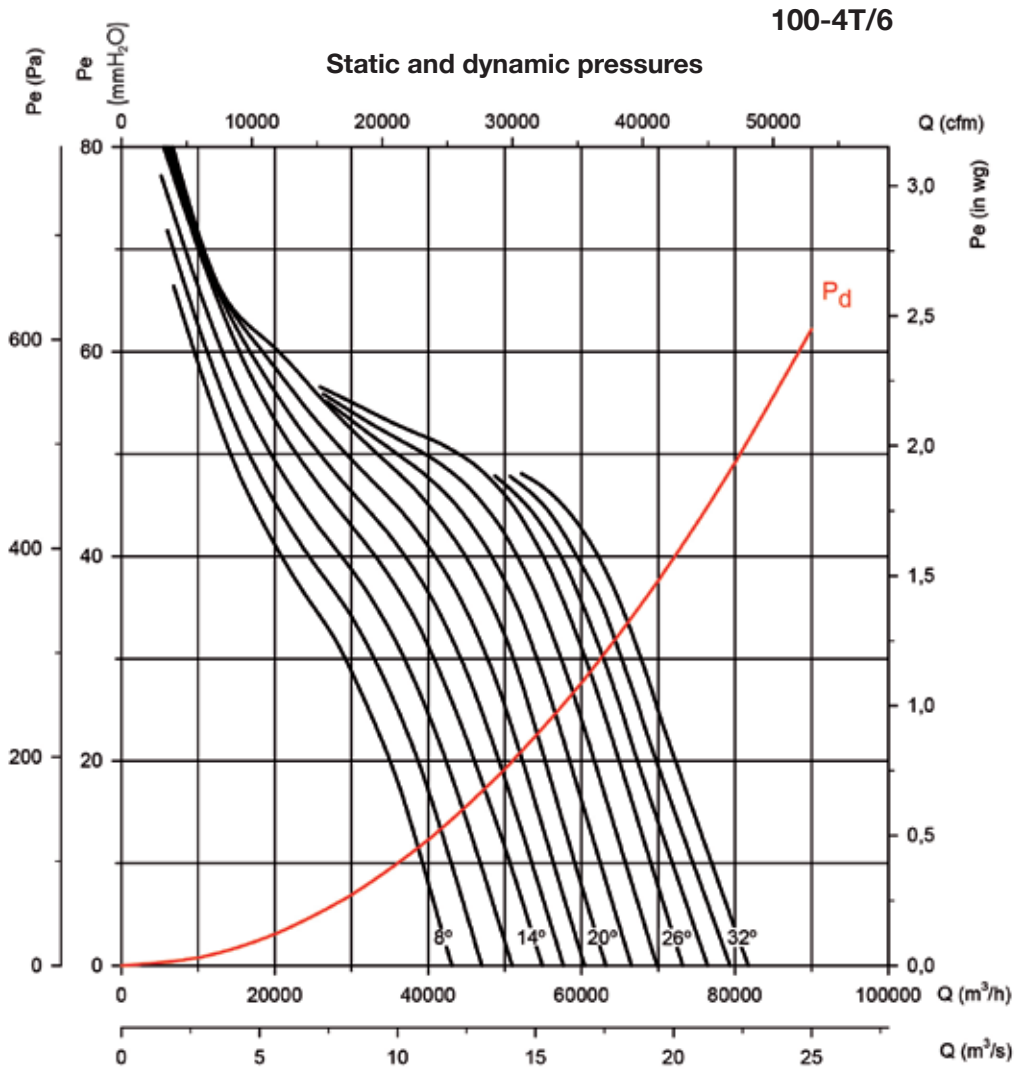

Absorbed power

Recommended Motor Power kW(hp)

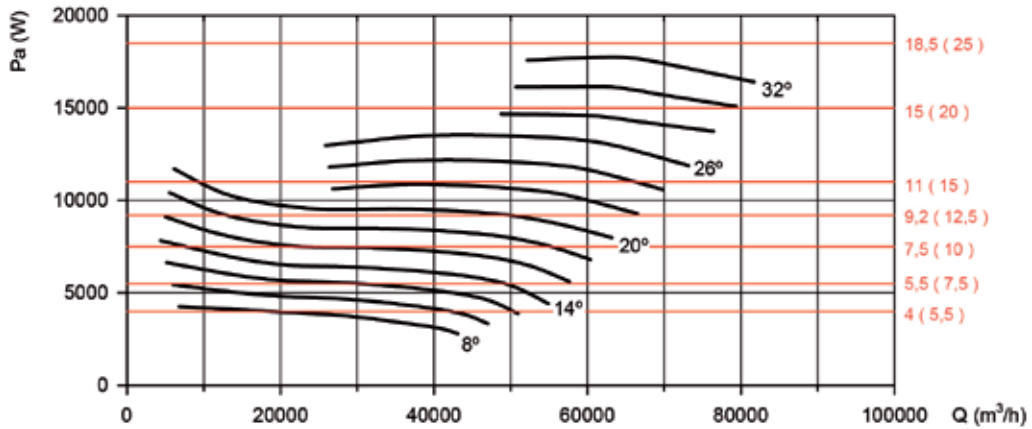

**Characteristic curves**

Q= Flow rate in m<sup>3</sup>/h, m<sup>3</sup>/s and cfm.

Pe= Static pressure in mm H<sub>2</sub>O, Pa and inwg.

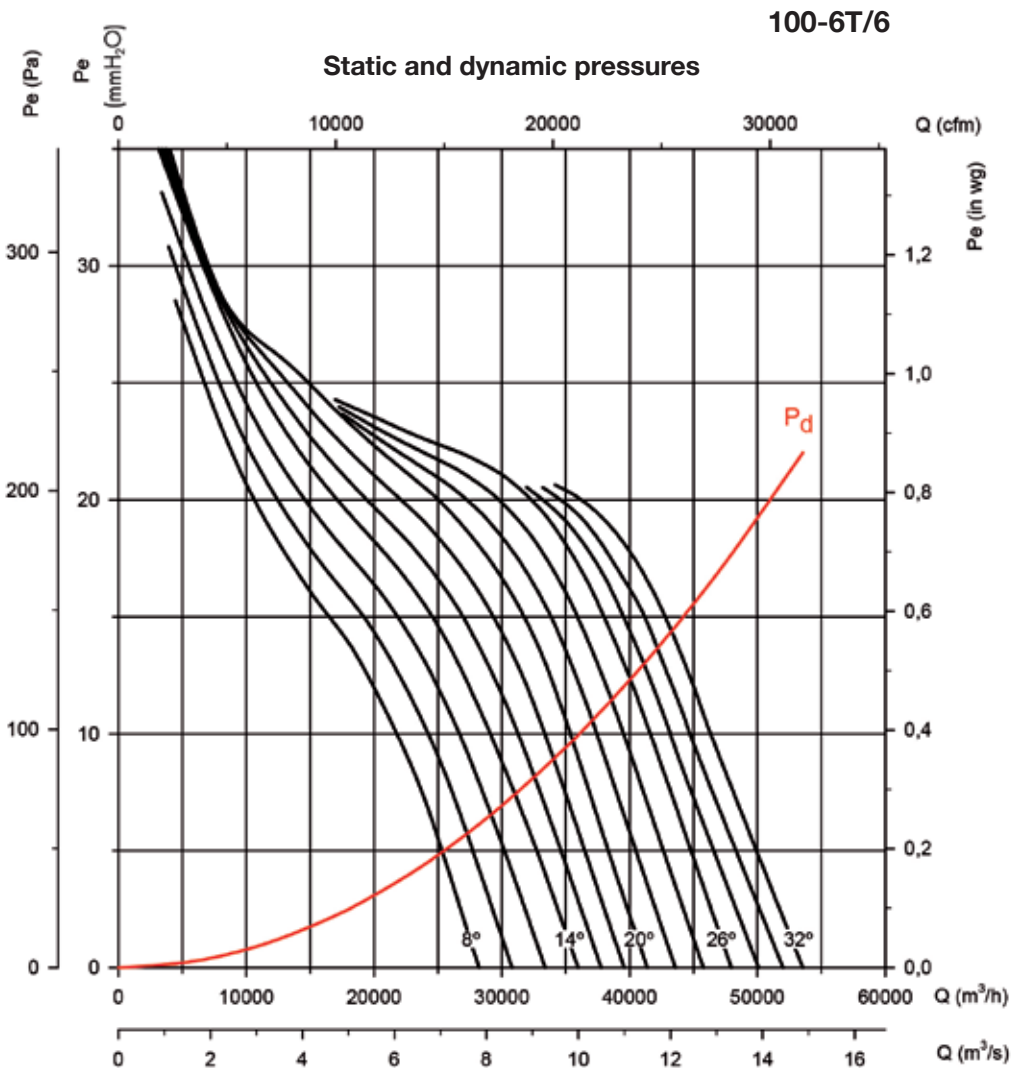

Absorbed power

Recommended Motor Power kW(hp)

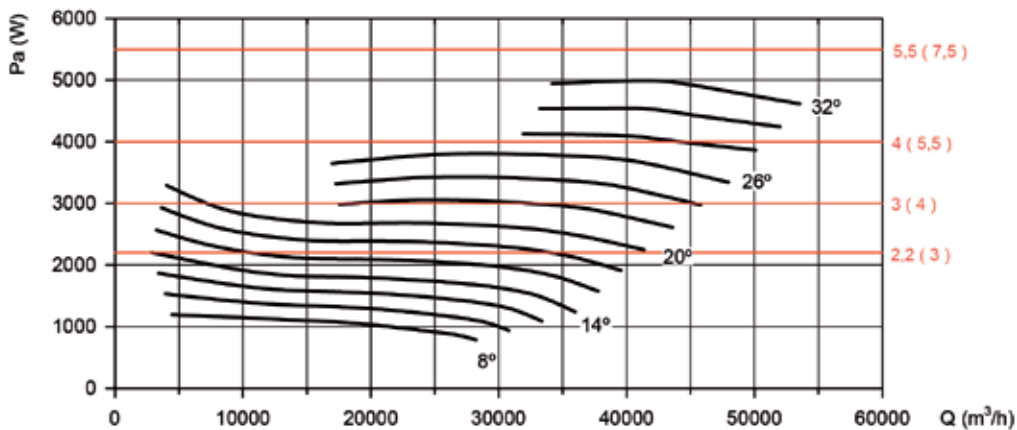

**Characteristic curves**

Q= Flow rate in m<sup>3</sup>/h, m<sup>3</sup>/s and cfm.

Pe= Static pressure in mm H<sub>2</sub>O, Pa and inwg.

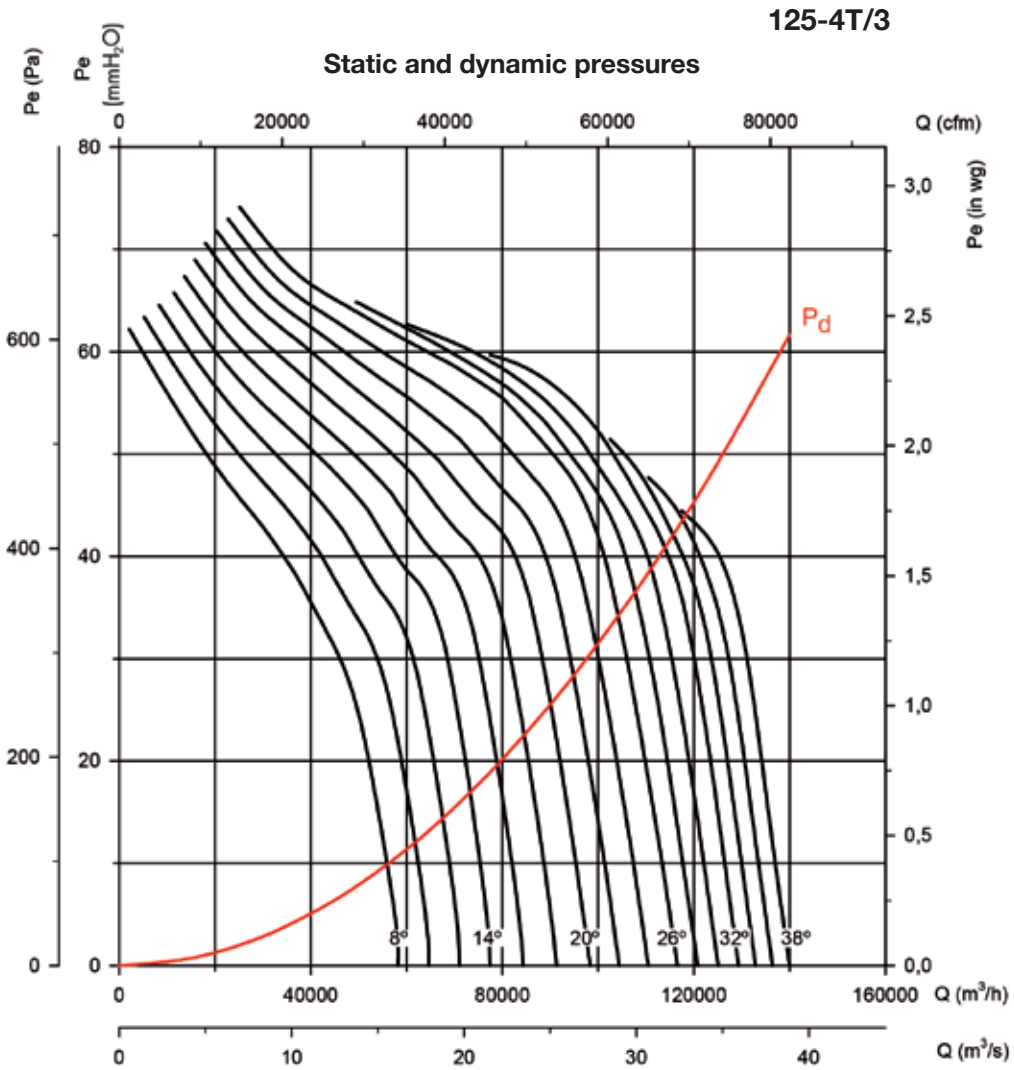

Absorbed power

Recommended Motor Power kW(hp)

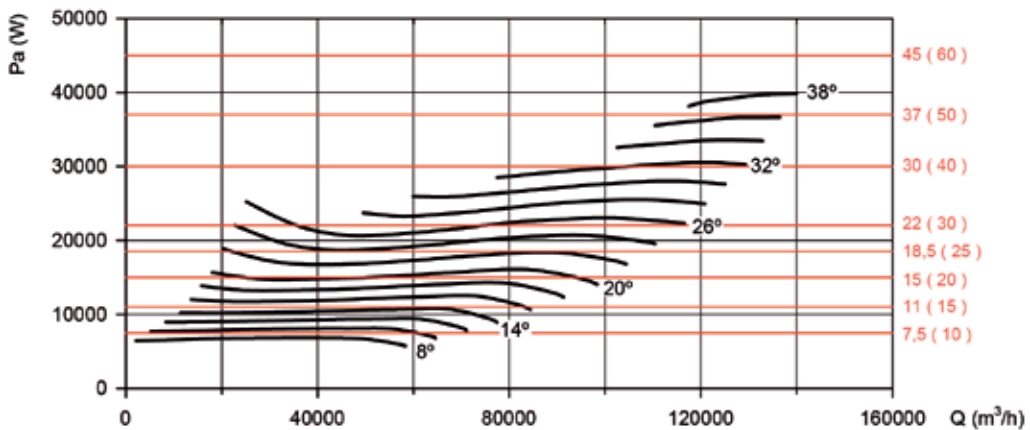

**Characteristic curves**

Q= Flow rate in m<sup>3</sup>/h, m<sup>3</sup>/s and cfm.

Pe= Static pressure in mm H<sub>2</sub>O, Pa and inwg.

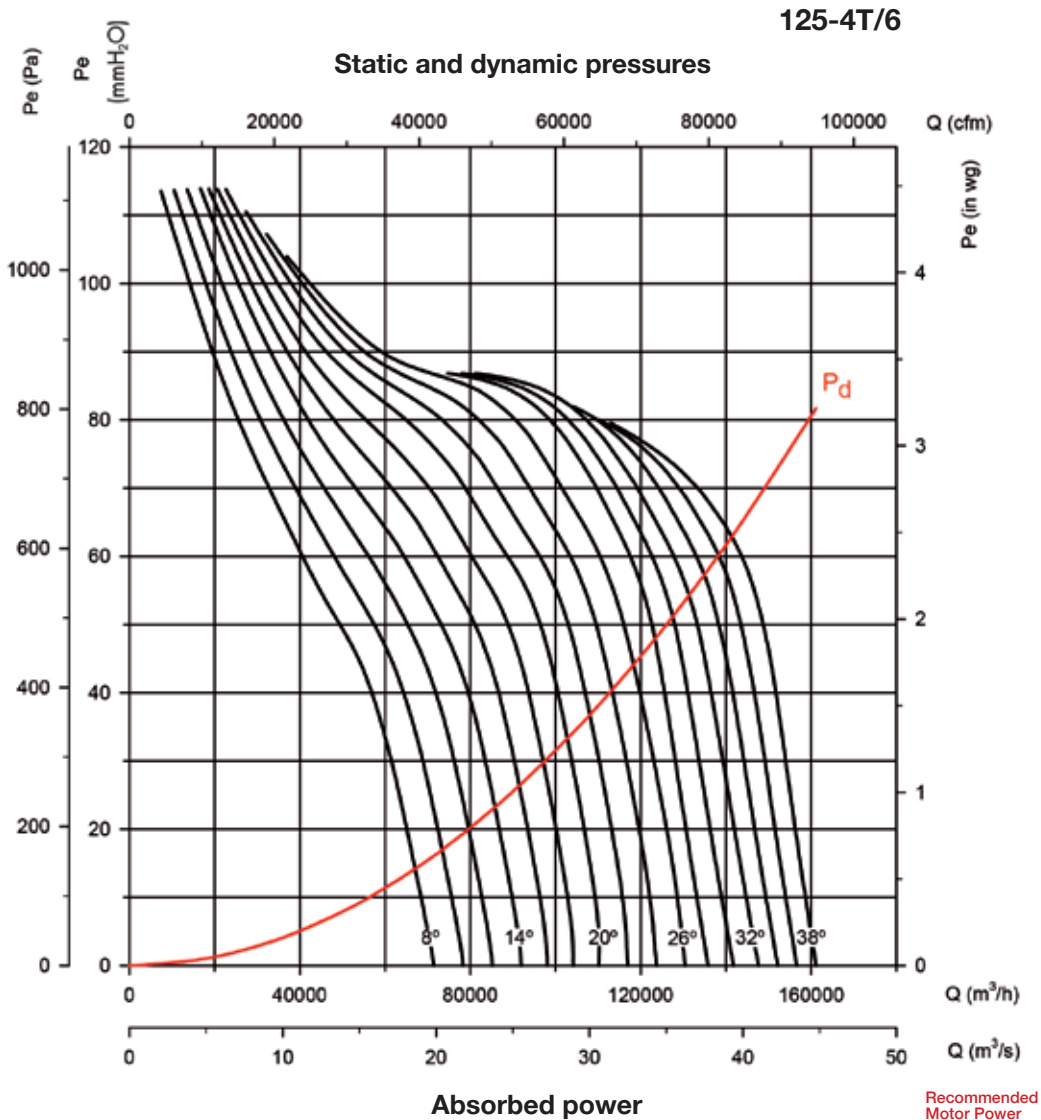

Absorbed power

Recommended Motor Power kW(hp)

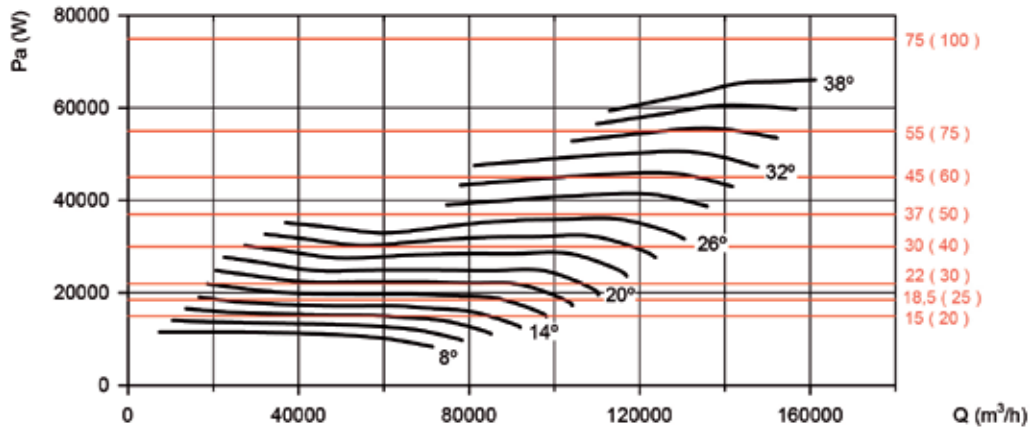

**Characteristic curves**

Q= Flow rate in m<sup>3</sup>/h, m<sup>3</sup>/s and cfm.

Pe= Static pressure in mm H<sub>2</sub>O, Pa and inwg.

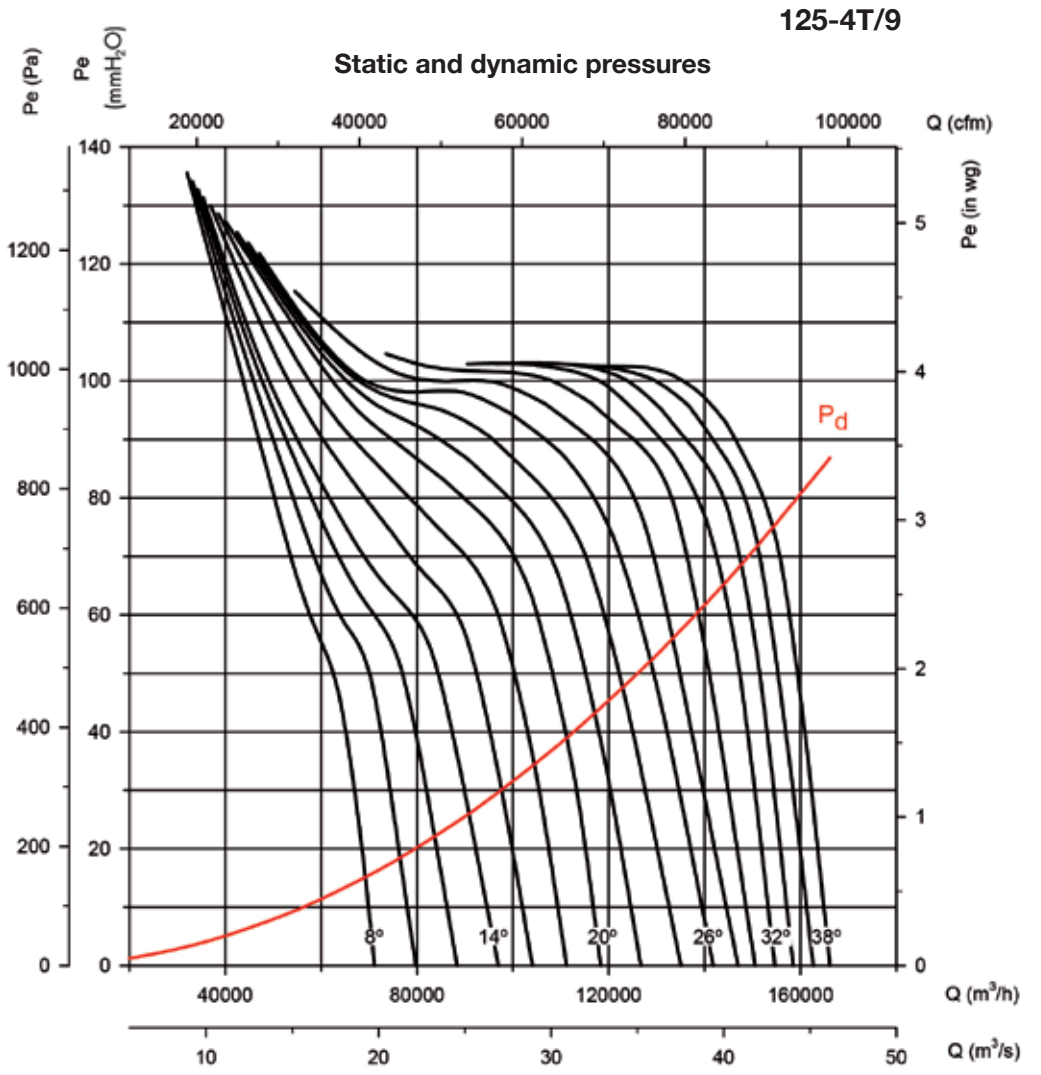

Absorbed power

Recommended Motor Power kW(hp)

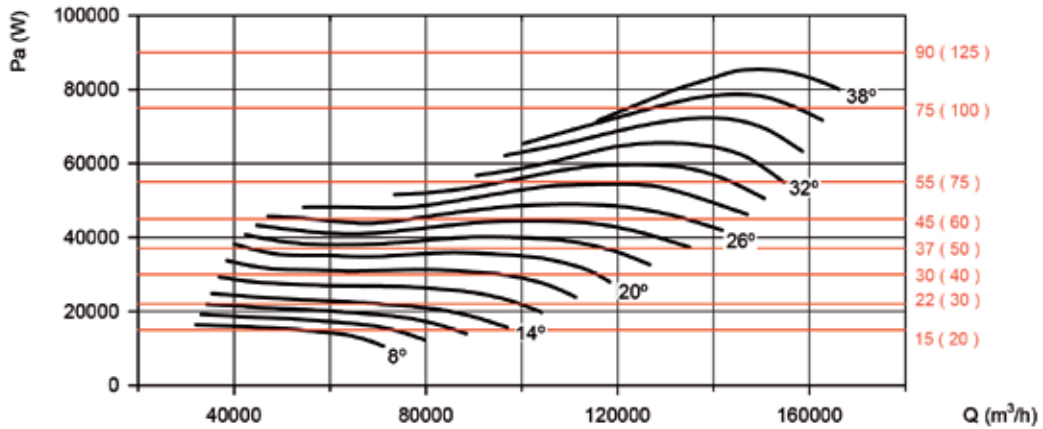

**Characteristic curves**

Q= Flow rate in m<sup>3</sup>/h, m<sup>3</sup>/s and cfm.

Pe= Static pressure in mm H<sub>2</sub>O, Pa and inwg.

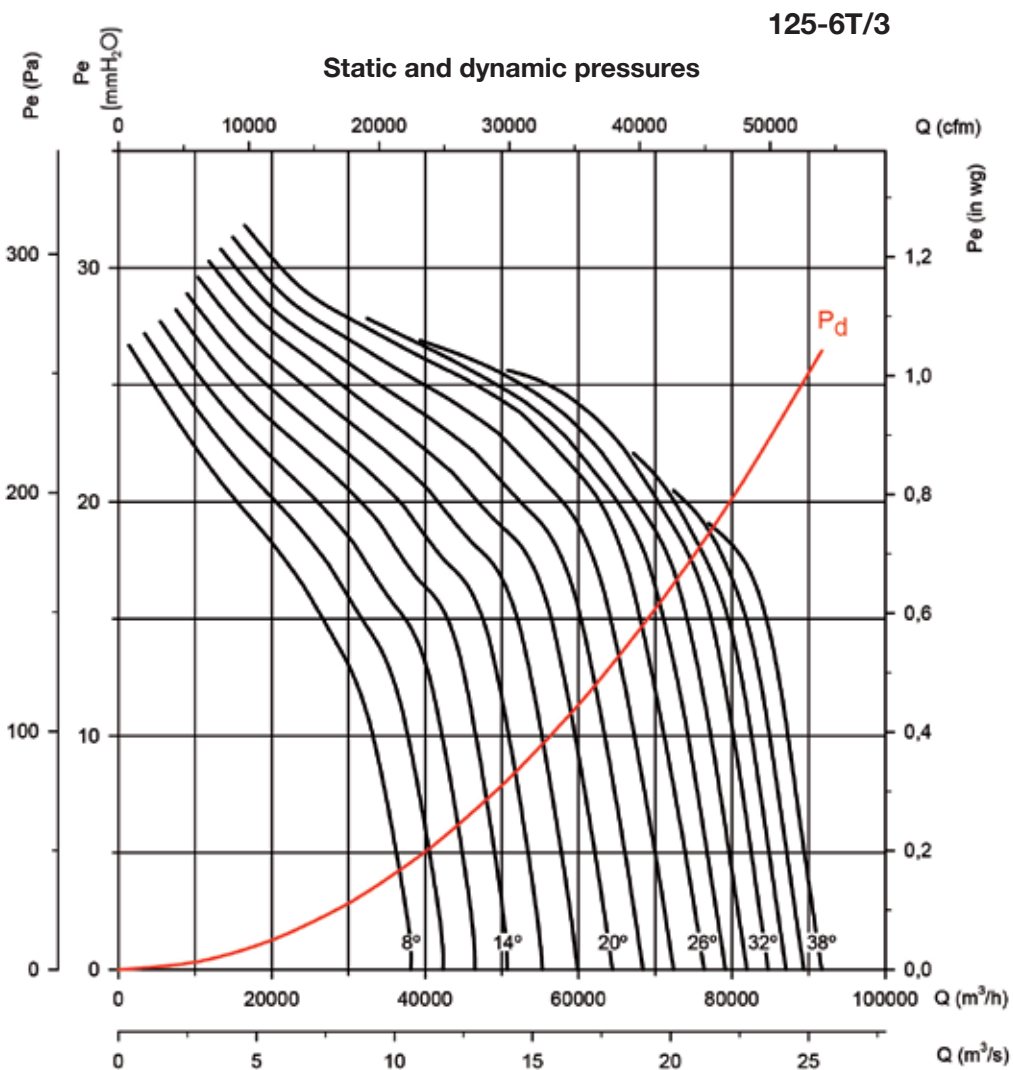

**Absorbed power**

Recommended Motor Power kW(hp)

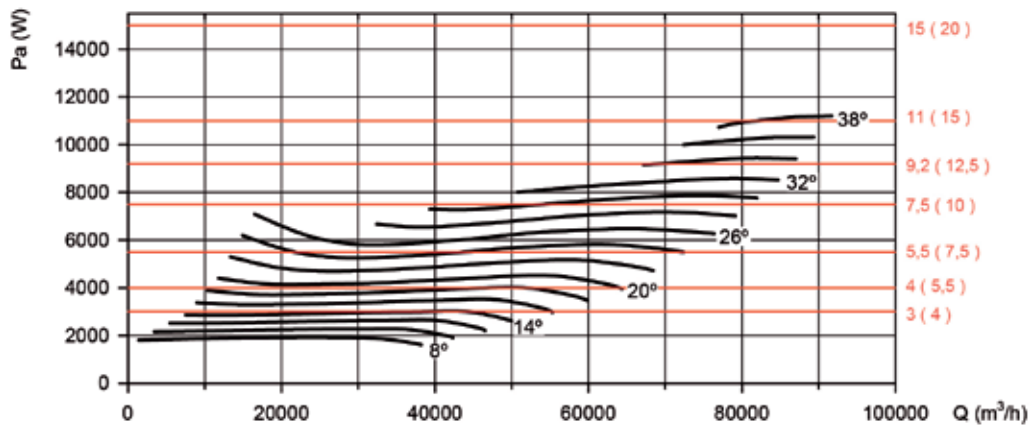



**Characteristic curves**

Q= Flow rate in m<sup>3</sup>/h, m<sup>3</sup>/s and cfm.

Pe= Static pressure in mm H<sub>2</sub>O, Pa and inwg.

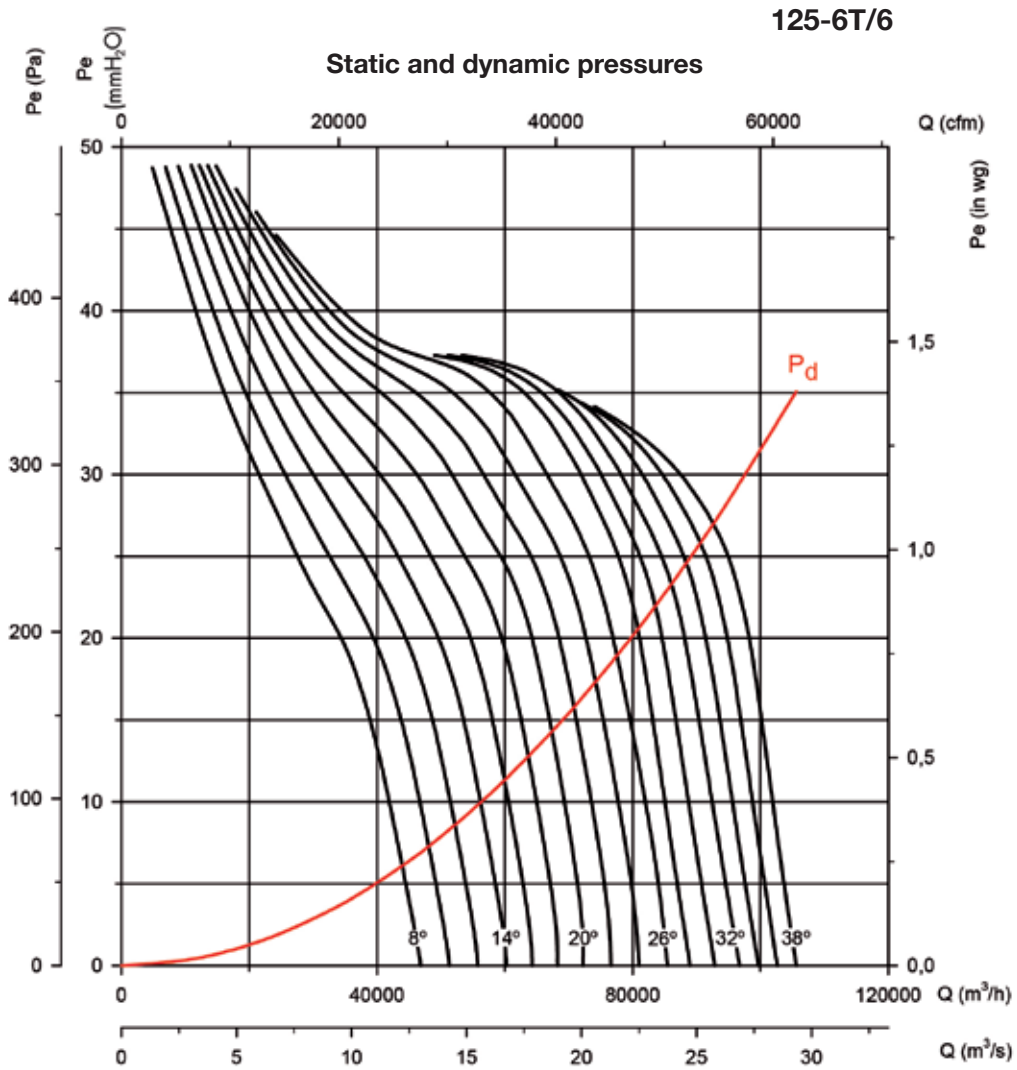

Absorbed power

Recommended Motor Power kW(hp)

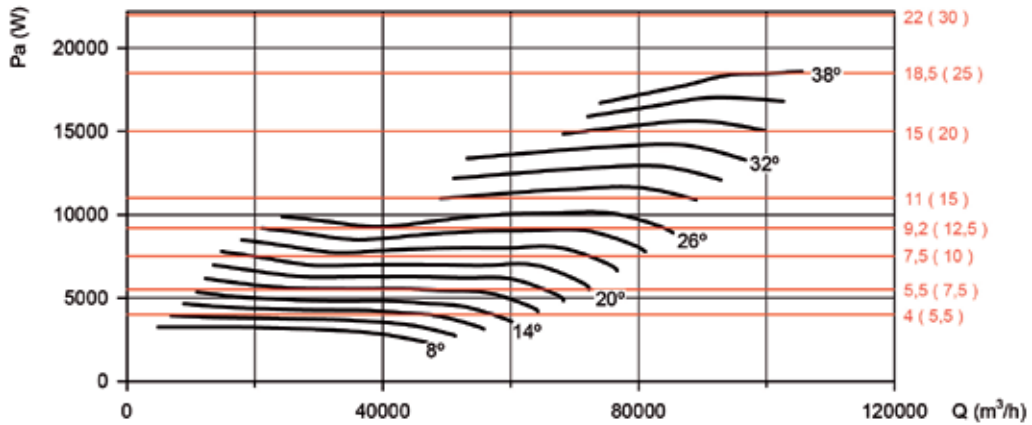

**Characteristic curves**

Q= Flow rate in m<sup>3</sup>/h, m<sup>3</sup>/s and cfm.

Pe= Static pressure in mm H<sub>2</sub>O, Pa and inwg.

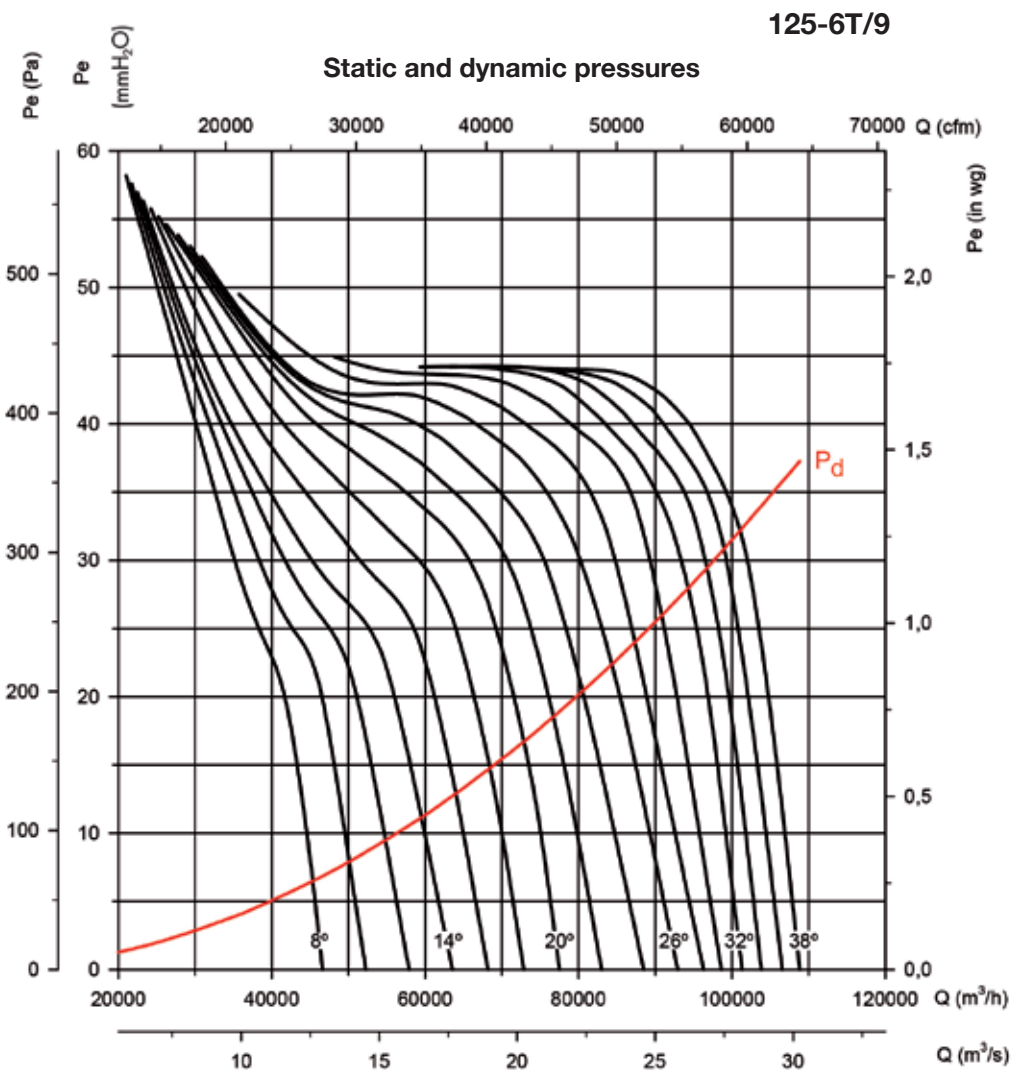

Absorbed power

Recommended Motor Power kW(hp)

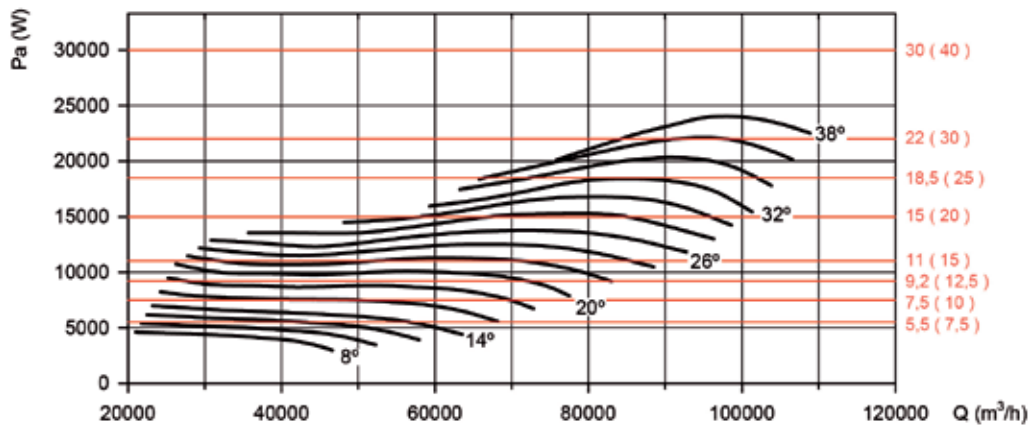

F-300 AND F-400 EXTRACTOR FANS FOR SMOKE EVACUATION IN CAR PARKS AND SIMILAR

F-400 CERTIFICATION



267

<p><b>THT</b></p>  <p>400 °C/2h and 300 °C/2h tubular axial extractor fans</p> <p>272</p>	<p><b>CJTHT</b></p>  <p>Axial fans 400°C/2h and 300°C/2h With sound-proofed box</p> <p>325</p>	<p><b>THT/IMP</b></p>  <p>300 °C/2h and 400 °C/2h long-range one-way or reversible jet fans with a circular or an octagonal design</p> <p>331</p>	<p><b>CI</b></p>  <p>300 °C/2h and 400 °C/2h long range induction centrifugal fans</p> <p>335</p>	<p><b>HTMF</b></p>  <p>400 °C/2h and 300 °C/2h roof-mounted multifunctional extractor fans</p> <p>336</p>
<p><b>THT/ROOF</b></p>  <p>400 °C/2h and 300 °C/2h roof-mounted axial extractor fans with vertical air outlet</p> <p>343</p>	<p><b>TCR/R</b></p>  <p>400 °C/2h centrifugal extractor fan with reaction impeller</p> <p>346</p>	<p><b>CJTCR/R</b></p>  <p>400 °C/2h extractor fan units with reaction impeller</p> <p>346</p>	<p><b>CJTX-C</b></p>  <p>400 °C/2h extractor fan units with motor and belt drive inside box</p> <p>351</p>	<p><b>CJSX</b></p>  <p>400 °C/2h belt-driven, single inlet extractor fan units</p> <p>359</p>
<p><b>CSX</b></p>  <p>400 °C/2h belt-driven centrifugal extractor fans with reaction impeller</p> <p>365</p>				



# EXTRACTOR FANS FOR SMOKE EVACUATION IN THE EVENT OF FIRE

Thanks to its knowledge gained during 25 years of experience in manufacturing fans for continuous operation at high temperatures, SODECA has become a specialist in the production of extractor fans for smoke evacuation in the event of fire and overpressure protection systems for smoke control in escape routes in the presence of fire.

Our production systems are certified by external control entities such as BUREAU VERITAS, and the quality controls performed on manufacturing processes and extractor control for smoke evacuation at high temperatures are also audited in full by independent organisations such as APPLUS, thus ensuring their correct operation and that they comply with the legislation and technical characteristics established for extractor fans.

All our extractor fans for smoke evacuation comply with European standard EN 12101-3:2002/AC:2006 "Powered smoke and heat exhaust ventilators for use in Construction Works", and are certified by an independent laboratory and accredited by the European directives.



# CERTIFIED EXTRACTOR FANS

## FOR SMOKE EVACUATION IN THE EVENT OF FIRE

### Smoke evacuation in: **CAR PARKS**

Smoke evacuation method with certified extractor fans for operating at high temperatures for a certain length of time, based on their classification and certification. This method is normally applied in buildings, shopping centres, tunnels, car parks and other large constructions with vast open areas, in industrial warehouses with a high risk of fire, and for smoke extraction in industrial kitchens.



#### FANS FOR IMMERSED OPERATION

Installation of fan for immersed operation in fire risk zone



THT



#### EXTERNAL FANS

Installation of outdoor fans in fire risk zone



CSX



CJTX-C



CJTCR/R



TCR/R



CJSX



#### JET FANS

Installation of jet fans for immersed operation in fire risk zones



THT/IMP-O



THT/IMP-L



CI

## Smoke evacuation in: **INDUSTRIAL KITCHENS**



Extractor fans suitable for use in industrial kitchens

For the correct application of the standard:

- C.T.E. Código Técnico de la Edificación (Technical Building Code). Basic Document SI on fire safety. Basic Document HS on health and safety.



## Smoke evacuation in: **INDUSTRIAL WAREHOUSES**



Extractor fans suitable for use in industrial warehouses

For the correct application of the standard:

- Regulations governing Fire Protection in Industrial Establishments, Royal Decree 2267/2004, EN-23585:2004 Fire Protection

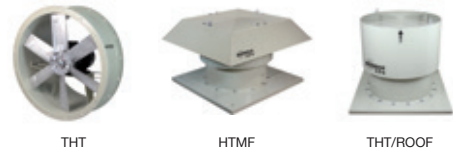

## Smoke control by differential pressure systems for: **EVACUATION ROUTES**

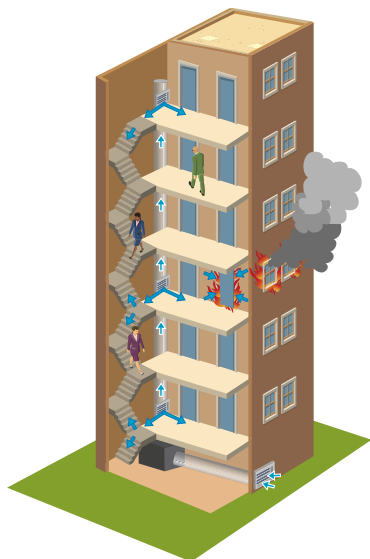

The overpressure smoke control method consists of pressurisation by injecting air into spaces which are used as escape routes by people in the case of fire, such as stairwells, corridors, passageways, lifts, etc., especially in tall buildings with large occupancy. The method is based on smoke control by the air speed and the artificial barrier created by air overpressure on the smoke, preventing it from entering the escape routes. In accordance with the EN-12101-6-2006 standards:

**STAIRCASE OVERPRESSURE KIT**  
For three-phase equipment



**STAIRCASE OVERPRESSURE KIT**  
For single-phase equipment



**KIT SOBREPRESIÓN WITH BACKUP FAN**





*CI installed in car park*



*CI installed in car park*



*Smoke machine for conducting real smoke tests*



*THT/IMP installed in car park*

# JET FANS

## VENTILATION IN CAR PARKS

### IMPULSE VENTILATION

As an alternative to traditional ventilation systems, in recent years horizontal ventilation systems (also known as impulse or induction ventilation systems) have been implemented, using extraction duct networks and the supply of air.

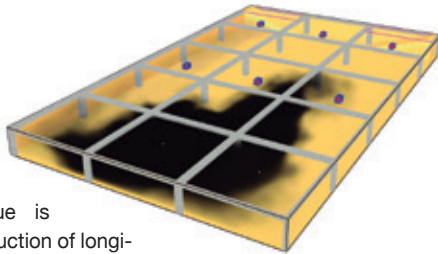

This new technique is based on the reproduction of longitudinal ventilation systems used in tunnels, creating an air front with a speed that is sufficient to provoke a sweep of the area to be ventilated.

The installation of fans at the air and smoke inlet and outlet points gives rise to the induction phenomenon, extracting the mass of air/smoke to the exterior.

This ventilation system is based on the impulsion of a small quantity of air at high speed, which generates a homogenisation effect on the rest of the air.

In addition, the system makes it possible to maintain really low contaminant gas levels, without having to start up the entire car park ventilation system.

By putting just two inductive fans into operation, or designing sector-based or phase ventilation systems and using a gas detection system, it is possible to achieve lower power consumption, less noise and extend the useful life of the equipment.

Impulse ventilation also enables the design of smoke-control systems in the event of fire in accordance with the three objectives set by the British and Belgian standards, which constitute the basis used by the European Standardisation Committee to draft the future European Standard on Car Park Smoke Control, EN 12101-11:

- Smoke extraction during and after fire (smoke clearance)
- Facilitate the work of the fire service (fire fighting)
- Facilitate the safe evacuation of occupants (means of escape)

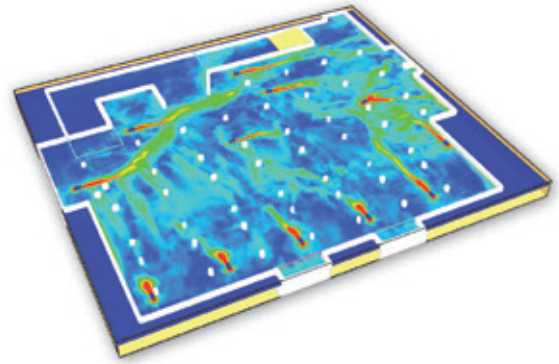

### SYSTEM BENEFITS

The two most important benefits of the impulse or induction ventilation system are:

- Maintaining of a low contaminant gas concentration level
- Increased safety in smoke control in the event of fire

Furthermore, these systems have the following additional benefits.

- They are faster and easier to install and generate less interference with other systems (sprinkler networks, electric ducts, drains)
- Lower occupancy under the slab, thus facilitating the installation of the ventilation system in car parks with lower heights and a reduction in excavation costs.
- Greater visibility in the car park, with the ensuing improved performance of CCTV systems.
- Reduction in the use of the ventilation system, as the fans do not have to overcome duct load losses, with fewer start-ups and hours of operation.

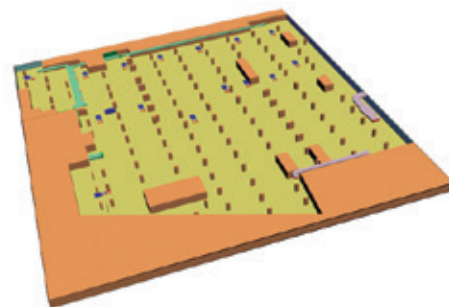

Examples of studies using computational fluid dynamics (CFD) simulations

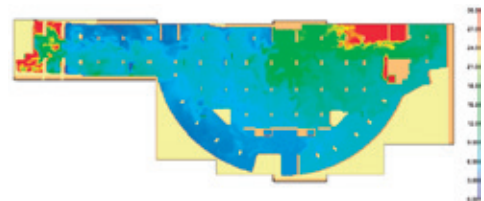

# THT



## 400 °C/2h and 300 °C/2h tubular axial extractor fans

400 °C/2h tubular axial extractor fans with short casings for immersed operation in fire risk zones.

### Fan:

- Sheet steel tubular casing.
- Cast aluminium orientable rotors.
- Approved in accordance with standard EN-12101-3-2002.
- Airflow direction from Motor to Impeller.

### Motor:

- Class H motors, S1 continuous operation and S2 emergency use, with ball bearings, IP55 protection and with 1 or 2 speeds, depending on model.
- Multi voltage motor, special design valid for 220/380V 60Hz, 254/440V 60Hz, 265/460V 60Hz, 277/480V 60Hz
- Maximum temperature of air to be carried: S1 continuous operation -20 °C +40 °C, S2 operation 300 °C/2h, 400 °C/2h.

### Finish:

- Anti-corrosive finish of polyester resin polymerised at 190 °C, previously degreased with phosphate-free nanotechnological treatment.

### On request:

- Long case fans fitted with an inspection hatch.
- Rotors 100 % reversible.



## Order code

### From size 40 to size 100

<b>THT</b>	—	<b>56</b>	—	<b>4T</b>	—	<b>2</b>	—	<b>F-400</b>	—	<b>60Hz</b>
THT: 400 °C/2h and 300 °C/2h tubular axial extractor fans THT/CL: 400 °C/2h and 300 °C/2h tubular axial extractor fans with long casings, fitted with inspection hatches		Rotor diameter in cm		Number of motor poles 2=3500 r/min. 60 Hz 4=1680 r/min. 60 Hz 6=1080 r/min. 60 Hz 8=900 r/min. 60 Hz 12=750 r/min. 60 Hz	T= Three-phase	Motor power (hp)		F-300: 300 °C/2h approved F-400: 400 °C/2h approved		

### From size 125 to size 160

<b>THT</b>	—	<b>125</b>	—	<b>4T</b>	—	<b>15</b>	—	<b>9-10</b>	—	<b>F-400</b>	—	<b>60Hz</b>
THT: 400 °C/2h and 300 °C/2h tubular axial extractor fans THT/CL: 400 °C/2h and 300 °C/2h tubular axial extractor fans with long casings, fitted with inspection hatches		Rotor diameter in cm		Number of motor poles 2=3500 r/min. 60 Hz 4=1680 r/min. 60 Hz 6=1080 r/min. 60 Hz 8=900 r/min. 60 Hz 12=750 r/min. 60 Hz	T= Three-phase	Motor power (c.v.)		Number of blades 3 blades 6 blades 9 blades	Blade inclination angle	F-300: 300 °C/2h approved F-400: 400 °C/2h approved		



## Technical characteristics

Model	Speed (r/min)	Maximum admissible current (A)		Installed power (kW)	Maximum flow rate (m³/h)	Sound pressure level dB(A)	Approx. weight (kg)	
		220-277V	380-480V				Long	Short
THT-40-2T-1.5	3455	4.70	2.70	1.10	6750	76	33	31
THT-40-2/4T-1.5	3505/1750		2.90/2.10	1.10/0.25	6750/3400	76/61	34	32
THT-40-2T-2	3455	5.90	3.40	1.50	7350	77	35	33
THT-40-2/4T-2	3530/1750		4.40/1.40	1.50/0.37	7350/3650	77/62	35	33
THT-40-4T-0.75	1690	2.73	1.57	0.55	5800	64	32	29
THT-40-6T-0.75	1150	4.10	2.40	0.55	3800	53	37	34
THT-40-6/12T-0.75	1130/530		1.60/0.55	0.55/0.09	3800/1750	53/38	41	38
THT-45-2T-2	3455	5.90	3.40	1.50	8800	78	38	34
THT-45-2/4T-2	3530/1750		5.70/1.80	1.50/0.37	8800/4400	78/63	37	34
THT-45-2T-3	3480	8.70	5.00	2.20	11300	80	39	36
THT-45-2/4T-3	3515/1740		4.40/1.40	2.20/0.60	11300/5650	80/65	39	36
THT-45-4T-0.75	1690	2.73	1.57	0.55	7500	68	34	30
THT-45-6T-0.75	1150	4.10	2.40	0.55	6050	55	38	35
THT-45-6/12T-0.75	1130/530		1.60/0.55	0.55/0.09	6050/2800	55/40	42	39
THT-50-2T-4	3455	11.20	6.50	3.00	12100	82	49	42
THT-50-2/4T-4	3505/1730		6.70/2.00	3.00/0.80	12100/6050	82/67	51	44
THT-50-2T-5.5	3470		9.30	4.00	14300	83	65	57
THT-50-2/4T-6	3515/1740		10.00/3.20	4.50/1.30	15400/7700	83/68	67	60
THT-50-4T-1	1700	3.50	2.03	0.75	8950	69	37	33
THT-50-6T-0.75	1150	4.10	2.40	0.55	9150	57	40	36
THT-50-6/12T-0.75	1130/530		1.60/0.55	0.55/0.09	9150/4250	57/42	44	40
THT-56-2T-5.5	3505		9.50	4.00	18150	88	69	60
THT-56-2/4T-6	3515/1740		10.00/3.20	4.50/1.30	19650/9800	88/72	71	63
THT-56-2T-12	3540		19.20	9.00	27000	89	147	139
THT-56-2/4T-12	3505/1730		20.70/5.50	9.00/2.50	27000/13500	89/74	137	129
THT-56-4T-1	1715	3.50	2.00	0.75	10550	73	45	40
THT-56-4T-1.5	1715	4.80	2.80	1.10	12750	74	44	40
THT-56-4/8T-1.5	1730/850		2.90/1.40	1.10/0.25	12750/6300	74/59	48	43
THT-56-4T-2	1705	6.20	3.60	1.50	15000	75	48	43
THT-56-4/8T-2	1700/860		3.60/1.50	1.50/0.30	15000/7400	75/60	59	55
THT-56-6T-0.75	1150	4.10	2.40	0.55	10650	62	44	39
THT-56-6/12T-0.75	1130/530		1.60/0.55	0.55/0.09	10650/4950	62/47	48	43
THT-63-2T-12	3540		19.20	9.00	33100	90	161	143
THT-63-2/4T-12	3505/1730		18.50/5.50	9.00/2.50	33100/16550	90/75	151	133
THT-63-2T-22	3550		32.30	16.00	44750	91	188	170
THT-63-2/4T-22	3550/1775		32.30/8.90	16.00/4.00	44750/22400	91/76	188	170
THT-63-4T-1	1715	3.50	2.00	0.75	13800	73	49	43
THT-63-4T-1.5	1715	4.80	2.80	1.10	16550	74	51	45
THT-63-4/8T-1.5	1730/850		2.90/1.40	1.10/0.25	16550/8200	74/59	55	49
THT-63-4T-2	1705	6.20	3.60	1.50	19100	75	55	49
THT-63-4/8T-2	1700/860		3.60/1.50	1.50/0.30	19100/9450	75/60	70	60
THT-63-4T-3	1715	9.00	5.20	2.20	22400	76	64	54
THT-63-4/8T-3	1700/860		5.20/1.90	2.20/0.45	22400/11050	76/61	77	66
THT-63-4T-4	1715	11.40	6.60	3.00	25150	77	73	63
THT-63-4/8T-4	1710/850		6.80/2.20	3.00/0.60	25150/12450	77/62	86	77
THT-63-6T-0.75	1150	4.10	2.40	0.55	14650	65	51	45
THT-63-6/12T-0.75	1130/530		1.60/0.55	0.55/0.09	14650/6800	65/50	55	49
THT-63-6T-1	1140	4.70	2.70	0.75	15900	66	54	48
THT-63-6/12T-1	1130/530		2.20/0.87	0.75/0.15	15900/7400	66/51	61	55
THT-71-4T-1.5	1715	4.80	2.80	1.10	19950	78	58	52
THT-71-4/8T-1.5	1730/850		2.90/1.40	1.10/0.25	19950/9850	78/63	61	56
THT-71-4T-2	1705	6.20	3.60	1.50	19950	79	61	56
THT-71-4/8T-2	1700/860		3.60/1.50	1.50/0.30	19950/9850	79/64	76	67
THT-71-4T-3	1715	9.00	5.20	2.20	25250	81	70	61
THT-71-4/8T-3	1700/860		5.20/1.90	2.20/0.45	25250/12450	81/66	82	74
THT-71-4T-4	1715	11.40	6.60	3.00	28100	82	79	70
THT-71-4/8T-4	1710/850		6.80/2.20	3.00/0.60	28100/13900	82/67	92	83
THT-71-6T-0.75	1150	4.10	2.40	0.55	15400	67	57	52

### Technical characteristics

Model	Speed (r/min)	Maximum admissible current (A)		Installed power (kW)	Maximum flow rate (m³/h)	Sound pressure level dB(A)	Approx. weight (kg)	
		220-277V	380-480V				Long	Short
THT-71-6/12T-0.75	1130/530		1.60/0.55	0.55/0.09	15400/7150	67/52	61	56
THT-71-6T-1	1140	4.70	2.70	0.75	17450	68	61	55
THT-71-6/12T-1	1130/530		2.20/0.87	0.75/0.15	17450/8100	68/53	67	62
THT-71-6T-1.5	1130	5.50	3.20	1.10	20300	69	69	61
THT-71-6/12T-1.5	1140/565		3.00/1.15	1.10/0.18	20300/9450	69/54	77	69
THT-80-4T-3	1715	9.00	5.20	2.20	25050	82	79	69
THT-80-4/8T-3	1700/860		5.20/1.90	2.20/0.45	25050/12400	82/67	91	82
THT-80-4T-4	1715	11.40	6.60	3.00	27850	83	88	78
THT-80-4/8T-4	1710/850		6.80/2.20	3.00/0.60	27850/13750	83/68	101	92
THT-80-4T-5.5	1720		8.40	4.00	33450	84	94	85
THT-80-4/8T-5.5	1745/870		9.30/3.40	4.00/0.80	33450/16550	84/69	127	118
THT-80-6T-1.5	1130	5.50	3.20	1.10	20100	72	78	69
THT-80-6/12T-1.5	1140/565		3.00/1.15	1.10/0.18	20100/9350	72/57	86	77
THT-80-6T-2	1135	7.40	4.30	1.50	23900	73	87	78
THT-80-6/12T-2	1140/550		4.60/1.90	1.50/0.25	23900/11100	73/58	91	82
THT-80-6T-3	1120	9.50	5.50	2.20	30150	74	94	84
THT-80-6/12T-3	1130/565		5.60/2.20	2.20/0.37	30150/14000	74/59	100	91
THT-80-8T-0.75	840	3.60	2.10	0.55	16550	70	71	62
THT-80-8T-1	850	4.80	2.80	0.75	19550	71	78	69
THT-90-4T-4	1715	11.40	6.60	3.00	34700	87	110	93
THT-90-4/8T-4	1710/850		6.80/2.20	3.00/0.60	34700/17150	87/72	124	106
THT-90-4T-5.5	1720		8.40	4.00	39900	89	117	99
THT-90-4/8T-5.5	1745/870		9.30/3.40	4.00/0.80	39900/19700	89/74	150	132
THT-90-4T-7.5	1750		12.60	5.50	43350	91	143	126
THT-90-4/8T-7.5	1745/870		12.80/4.60	5.50/1.10	43350/21450	91/76	157	140
THT-90-4T-10	1750		17.70	7.50	50000	92	154	137
THT-90-4/8T-9	1745/870		15.60/6.30	6.70/1.50	46850/23150	92/77	157	140
THT-90-6T-2	1135	7.40	4.30	1.50	28400	77	110	92
THT-90-6/12T-2	1140/550		4.60/1.90	1.50/0.25	28400/13200	77/62	114	96
THT-90-6T-3	1120	9.50	5.50	2.20	32750	78	116	99
THT-90-6/12T-3	1130/565		5.60/2.20	2.20/0.37	32750/15250	78/63	123	105
THT-90-6T-4	1165	13.50	7.80	3.00	38150	79	142	124
THT-90-6/12T-4	1150/570		8.90/3.50	3.00/0.55	38150/17750	79/64	143	126
THT-90-8T-1	850	4.80	2.80	0.75	23150	71	100	84
THT-90-8T-2	850	7.80	4.50	1.50	29850	73	116	99
THT-90-8T-3	850	11.40	6.60	2.20	35350	74	134	116
THT-100-4T-7.5	1750		12.60	5.50	51700	92	151	131
THT-100-4/8T-7.5	1745/870		12.80/4.60	5.50/1.10	46950/23200	92/77	165	145
THT-100-4T-10	1750		17.70	7.50	56400	93	162	142
THT-100-4/8T-9	1745/870		15.60/6.30	6.70/1.50	56400/27900	93/78	165	145
THT-100-4T-15	1750		22.00	11.00	65850	94	215	195
THT-100-4/8T-15	1765/870		23.20/8.70	11.00/2.80	65850/32550	94/79	215	195
THT-100-4T-20	1750		29.00	15.00	72500	95	230	210
THT-100-4/8T-20	1765/870		31.70/11.80	15.00/3.80	72500/35850	95/80	230	210
THT-100-6T-3	1120	9.50	5.50	2.20	36950	82	124	105
THT-100-6/12T-3	1130/565		5.60/2.20	2.20/0.37	36950/17200	82/67	130	112
THT-100-6T-4	1165	13.50	7.80	3.00	43150	83	150	130
THT-100-6/12T-4	1150/570		8.90/3.50	3.00/0.55	43150/20050	83/68	151	131
THT-100-6T-5.5	1165		11.00	4.00	47500	84	162	142
THT-100-6/12T-5.5	1165/575		11.30/4.20	4.00/0.65	47500/22100	84/69	162	142
THT-100-8T-2	850	7.80	4.50	1.50	32550	77	124	105
THT-100-8T-3	850	11.40	6.60	2.20	37450	77	142	122
THT-100-8T-4	850	15.60	9.00	3.00	43400	78	162	142
THT-125-4T/3-10	1750		17.70	7.50	54400	88	243	210
THT-125-4/8T/3-9	1745/870		15.60/6.30	6.70/1.50	50550/25000	88/68	243	210
THT-125-4T/3-15	1750		22.00	11.00	69800	89	294	266
THT-125-4/8T/3-15	1765/870		23.20/8.70	11.00/2.80	69800/34500	89/69	294	266
THT-125-4T/3-20	1750		29.00	15.00	77500	91	309	281

**Technical characteristics**

Model	Speed (r/min)	Maximum admissible current (A)		Installed power (kW)	Maximum flow rate (m³/h)	Sound pressure level dB(A)	Approx. weight (kg)	
		220-277V	380-480V				Long	Short
THT-125-4/8T/3-20	1765/870		31.70/11.80	15.00/3.80	77500/38300	91/71	309	281
THT-125-4T/3-25	1760		37.00	18.50	92950	91	377	334
THT-125-4T/3-30	1765		42.00	22.00	101300	92	391	348
THT-125-4/8T/3-27	1765/880		38.00/13.00	20.00/4.00	92950/45950	92/71	391	348
THT-125-4/8T/3-37	1770/880		51.00/20.60	27.00/6.00	118000/58350	93/72	472	429
THT-125-4T/3-40	1770		58.00	30.00	118000	93	472	429
THT-125-4/8T/3-40	1775/880		62.00/27.00	30.00/10.00	118000/58350	93/72	618	562
THT-125-4T/6-20	1750		29.00	15.00	69250	89	318	290
THT-125-4/8T/6-20	1765/870		31.70/11.80	15.00/3.80	73400/36250	89/68	318	290
THT-125-4/8T/6-22	1765/880		31.80/12.00	16.50/3.30	77500/38300	89/69	303	275
THT-125-4T/6-25	1760		37.00	18.50	81600	90	386	343
THT-125-4/8T/6-27	1765/880		38.00/13.00	20.00/4.00	85750/42350	90/69	400	357
THT-125-4T/6-30	1765		42.00	22.00	93950	90	400	357
THT-125-4/8T/6-37	1770/880		51.00/20.60	27.00/6.00	102200/50500	90/70	481	437
THT-125-4T/6-40	1770		58.00	30.00	110400	92	481	437
THT-125-4/8T/6-40	1775/880		62.00/27.00	30.00/10.00	110400/54600	92/71	627	571
THT-125-4T/6-50	1775		73.00	37.00	117700	93	529	473
THT-125-4T/9-25	1760		37.00	18.50	69850	88	395	352
THT-125-4/8T/9-22	1765/880		31.80/12.00	16.50/3.30	59500/29400	88/69	312	284
THT-125-4T/9-30	1765		42.00	22.00	85350	89	409	366
THT-125-4/8T/9-27	1765/880		38.00/13.00	20.00/4.00	75000	89/70	409	366
THT-125-4/8T/9-37	1770/880		51.00/20.60	27.00/6.00	85350/42200	90/70	490	446
THT-125-4T/9-40	1770		58.00	30.00	95700	91	490	446
THT-125-4/8T/9-40	1775/880		62.00/27.00	30.00/10.00	95700/47300	91/71	636	580
THT-125-4T/9-50	1775		73.00	37.00	106050	93	538	482
THT-125-6T/3-4	1165	13.50	7.80	3.00	35650	79	230	197
THT-125-6/12T/3-4	1150/570		8.90/3.50	3.00/0.55	40700/18900	79/64	232	199
THT-125-6T/3-5.5	1165		11.00	4.00	50800	80	242	209
THT-125-6/12T/3-5.5	1165/575		11.30/4.20	4.00/0.65	50800/23600	80/65	243	210
THT-125-6T/3-7.5	1165		12.40	5.50	60900	81	249	216
THT-125-6/12T/3-7.5	1165/575		13.20/5.30	5.50/1.00	60900/28300	81/66	263	230
THT-125-6T/3-10	1165		17.00	7.50	71850	83	274	246
THT-125-6/12T/3-10	1150/565		20.00/9.00	7.50/1.40	71850/33400	83/68	294	266
THT-125-6T/3-15	1145		26.00	11.00	91650	84	304	276
THT-125-6/12T/3-15	1150/565		28.50/13.00	11.00/2.00	91650/42600	84/69	309	281
THT-125-6T/3-20	1170		31.00	15.00	101650	85	377	334
THT-125-6/12T/3-24	1165/575		36.00/14.50	17.50/3.50	104450/48550	85/70	472	429
THT-125-6T/6-5.5	1165		11.00	4.00	45400	77	251	218
THT-125-6/12T/6-5.5	1165/575		11.30/4.20	4.00/0.65	50750/23600	77/62	252	219
THT-125-6T/6-7.5	1165		12.40	5.50	56150	77	258	225
THT-125-6/12T/6-7.5	1165/575		13.20/5.30	5.50/1.00	56150/26100	77/62	272	239
THT-125-6T/6-10	1165		17.00	7.50	66950	79	283	255
THT-125-6/12T/6-10	1150/565		20.00/9.00	7.50/1.40	66950/31150	79/64	303	275
THT-125-6T/6-15	1145		26.00	11.00	81900	81	313	285
THT-125-6/12T/6-15	1150/565		28.50/13.00	11.00/2.00	81900/38100	81/66	318	290
THT-125-6T/6-20	1170		31.00	15.00	91950	82	386	343
THT-125-6/12T/6-24	1165/575		36.00/14.50	17.50/3.50	102550/47700	82/67	481	437
THT-125-6T/9-10	1165		17.00	7.50	55900	78	292	264
THT-125-6/12T/9-10	1150/565		20.00/9.00	7.50/1.40	55900/26000	78/63	312	284
THT-125-6T/9-15	1145		26.00	11.00	76250	81	322	294
THT-125-6/12T/9-15	1150/565		28.50/13.00	11.00/2.00	76250/35450	81/66	327	299
THT-125-6T/9-20	1170		31.00	15.00	87450	84	395	352
THT-125-6/12T/9-24	1165/575		36.00/14.50	17.50/3.50	93050/43250	84/69	490	446
THT-140-6T/3-5.5	1130		8.72	4.00	47700	83	279	242
THT-140-6T/3-7.5	1150		12.20	5.50	61200	84	287	250
THT-140-6T/3-10	1165		15.60	7.50	67950	85	339	300
THT-140-6T/3-15	1165		23.30	11.00	88800	86	356	317
THT-140-6T/3-20	1165		27.40	15.00	103450	88	436	386

### Technical characteristics

Model	Speed (r/min)	Maximum admissible current (A)		Installed power (kW)	Maximum flow rate (m³/h)	Sound pressure level dB(A)	Approx. weight (kg)	
		220-277V	380-480V				Long	Short
THT-140-6T/6-7.5	1150		12.20	5.50	60700	84	297	260
THT-140-6T/6-10	1165		15.60	7.50	67950	85	349	310
THT-140-6T/6-15	1165		23.30	11.00	82350	86	366	327
THT-140-6T/6-20	1165		27.40	15.00	96800	87	445	396
THT-140-6T/6-25	1170		34.40	18.50	103200	88	497	448
THT-140-6T/6-30	1170		41.40	22.00	116000	89	506	457
THT-140-6T/9-10	1165		15.60	7.50	56700	84	358	319
THT-140-6T/9-15	1165		23.30	11.00	74850	86	375	336
THT-140-6T/9-20	1165		27.40	15.00	83900	87	455	405
THT-140-6T/9-25	1170		34.40	18.50	102050	88	506	458
THT-140-6T/9-30	1170		41.40	22.00	109500	89	515	467
THT-140-6T/9-40	1180		54.20	30.00	124500	91	673	611
THT-140-6T/9-50	1175		66.40	37.00	133300	92	751	696
THT-140-8T/3-3	860	9.17	5.27	2.20	41050	78	279	242
THT-140-8T/3-4	850	12.50	7.20	3.00	51250	78	287	250
THT-140-8T/3-5.5	875		10.40	4.00	61450	79	337	298
THT-140-8T/3-7.5	875		13.80	5.50	72500	81	346	307
THT-140-8T/3-10	870		17.80	7.50	87700	82	357	318
THT-140-8T/6-3	860	9.17	5.27	2.20	45800	78	289	252
THT-140-8T/6-4	850	12.50	7.20	3.00	51250	79	297	260
THT-140-8T/6-5.5	875		10.40	4.00	56700	80	347	308
THT-140-8T/6-7.5	875		13.80	5.50	67600	81	356	317
THT-140-8T/6-10	870		17.80	7.50	77850	82	367	328
THT-140-8T/6-15	870		21.70	11.00	92850	83	453	404
THT-140-8T/9-4	850	12.50	7.20	3.00	42750	79	306	269
THT-140-8T/9-5.5	875		10.40	4.00	49600	79	356	317
THT-140-8T/9-7.5	875		13.80	5.50	56450	81	365	326
THT-140-8T/9-10	870		17.80	7.50	70150	82	376	337
THT-140-8T/9-15	870		21.70	11.00	82600	83	463	413
THT-140-8T/9-20	870		32.90	15.00	100550	86	516	468
THT-160-6T/3-10	1165		15.60	7.50	71150	83	412	358
THT-160-6T/3-15	1165		23.30	11.00	91350	85	429	375
THT-160-6T/3-20	1165		27.40	15.00	101450	86	522	453
THT-160-6T/3-25	1170		34.40	18.50	121600	87	574	504
THT-160-6T/3-30	1170		41.40	22.00	132550	89	583	513
THT-160-6T/6-15	1165		23.30	11.00	90650	85	440	386
THT-160-6T/6-20	1165		27.40	15.00	101400	86	532	463
THT-160-6T/6-25	1170		34.40	18.50	112200	87	584	515
THT-160-6T/6-30	1170		41.40	22.00	122950	88	593	524
THT-160-6T/6-40	1180		54.20	30.00	144500	89	768	669
THT-160-6T/6-50	1175		66.40	37.00	163600	91	842	757
THT-160-6T/9-15	1165		23.30	11.00	71100	85	450	396
THT-160-6T/9-20	1165		27.40	15.00	84600	86	542	473
THT-160-6T/9-25	1170		34.40	18.50	98150	87	594	525
THT-160-6T/9-30	1170		41.40	22.00	111700	88	603	534
THT-160-6T/9-40	1180		54.20	30.00	125250	89	778	679
THT-160-6T/9-50	1175		66.40	37.00	152300	90	852	768
THT-160-6T/9-60	1180		84.50	45.00	163500	91	1067	968
THT-160-6T/9-75	1180		100.00	55.00	174650	92	1112	1013
THT-160-8T/3-4	850	12.50	7.20	3.00	53700	77	356	304
THT-160-8T/3-5.5	875		10.40	4.00	61300	79	410	356
THT-160-8T/3-7.5	875		13.80	5.50	68900	80	419	365
THT-160-8T/3-10	870		17.80	7.50	84150	81	430	376
THT-160-8T/3-15	870		21.70	11.00	108250	83	530	461
THT-160-8T/6-5.5	875		10.40	4.00	68350	77	421	367
THT-160-8T/6-7.5	875		13.80	5.50	76500	79	430	376
THT-160-8T/6-10	870		17.80	7.50	84650	80	441	387
THT-160-8T/6-15	870		21.70	11.00	100900	82	540	471

### Technical characteristics

Model	Speed (r/min)	Maximum admissible current (A)		Installed power (kW)	Maximum flow rate (m³/h)	Sound pressure level dB(A)	Approx. weight (kg)	
		220-277V	380-480V				Long	Short
THT-160-8T/6-20	870		32.90	15.00	116200	83	594	525
THT-160-8T/6-25	875		34.90	18.50	130600	84	741	642
THT-160-8T/9-7.5	875		13.80	5.50	63850	79	440	386
THT-160-8T/9-10	870		17.80	7.50	74050	80	451	397
THT-160-8T/9-15	870		21.70	11.00	84250	82	550	481
THT-160-8T/9-20	870		32.90	15.00	104700	83	604	535
THT-160-8T/9-25	875		34.90	18.50	114900	84	751	652
THT-160-8T/9-30	875		41.10	22.00	131750	85	776	677
THT-160-8T/9-40	875		56.30	30.00	150100	86	837	753

### Acoustic characteristics

The indicated values are determined by measuring the sound pressure level and sound power in dB(A) obtained in a free field at a distance equivalent to twice the size of the fan plus the rotor diameter, with a minimum of 1.5 m.

Sound power spectrum Lw(A) in dB(A) per Hz frequency band

Model	63	125	250	500	1000	2000	4000	8000	Model	63	125	250	500	1000	2000	4000	8000
40-2-1.5	48	69	76	81	84	80	73	62	71-12-0.75	29	44	52	57	59	56	49	38
40-2-2	49	70	77	82	85	81	74	63	71-12-1	30	46	54	59	61	58	51	40
40-4-0.75	36	57	64	69	72	68	61	50	71-12-1.5	31	46	54	59	61	58	51	40
40-4-1.5	33	54	61	66	69	65	58	47	80-4-3	57	77	85	90	92	89	82	73
40-4-2	34	55	62	67	70	66	59	48	80-4-4	56	76	84	89	91	88	81	74
40-6	25	46	53	58	61	57	50	39	80-4-5.5	56	76	84	89	91	88	81	70
40-12	10	31	38	43	46	42	35	24	80-6-1.5	49	66	74	79	81	78	71	60
45-2-2	50	71	78	83	86	82	75	64	80-6-2	50	67	75	80	82	79	72	61
45-2-3	52	73	80	85	88	84	77	66	80-6-3	51	68	76	81	83	80	73	62
45-4-0.75	40	61	68	73	76	72	65	54	80-8-0.75	47	60	68	73	75	72	65	54
45-4-2	35	56	63	68	71	67	60	49	80-8-1	48	61	69	74	76	73	66	55
45-4-3	37	58	65	70	73	69	62	51	80-8-3	42	62	70	75	77	74	67	58
45-6	27	48	55	60	63	59	52	41	80-8-4	41	61	69	74	76	73	66	59
45-12	12	33	40	45	48	44	37	26	80-8-5.5	40	60	68	73	75	72	65	59
50-2-4	57	77	85	90	92	89	82	71	80-12-1.5	34	49	57	62	64	61	54	43
50-2-5.5	58	78	86	91	93	90	83	72	80-12-2	35	50	58	63	65	62	55	44
50-2-6	58	78	86	91	93	90	83	72	80-12-3	36	51	59	64	66	63	56	45
50-4-1	44	64	72	77	79	76	69	58	90-4-4	61	82	89	94	97	93	86	79
50-4-4	42	62	70	75	77	74	67	56	90-4-5.5	60	81	88	93	96	92	85	74
50-4-6	43	63	71	76	78	75	68	57	90-4-7.5	59	80	87	92	95	91	84	73
50-6	32	52	60	65	67	64	57	46	90-4-9	58	79	86	91	94	90	83	72
50-12	17	37	45	50	52	49	42	31	90-4-10	58	79	86	91	94	90	83	72
50-2-5.5	63	83	91	96	98	95	88	77	90-6-2	49	70	77	82	85	81	74	63
56-2-6	63	83	91	96	98	95	88	77	90-6-3	56	70	77	82	85	81	74	63
56-2-12	64	84	92	97	99	96	89	78	90-6-4	57	72	79	84	87	83	76	65
56-4-1	48	68	76	81	83	80	73	62	90-8-1	42	63	70	75	78	74	67	56
56-4-1.5	49	69	77	82	84	81	74	63	90-8-2	51	66	73	78	81	77	70	59
56-4-2	50	70	78	83	85	82	75	64	90-8-3	52	66	73	78	81	77	70	59
56-4-6	48	68	76	81	83	80	73	62	90-8-4	46	67	74	79	82	78	71	64
56-4-12	49	69	77	82	84	81	74	63	90-8-5.5	45	66	73	78	81	77	70	59
56-6	37	57	65	70	72	69	62	51	90-8-7.5	43	64	71	76	79	75	68	57
56-8-1.5	34	54	62	67	69	66	59	48	90-8-9	43	64	71	76	79	75	68	57
56-8-2	35	55	63	68	70	67	60	49	90-12-2	32	53	60	65	68	64	57	46
56-12	22	42	50	55	57	54	47	36	90-12-3	41	53	60	65	68	64	57	46
63-2-12	67	87	95	100	102	99	92	81	90-12-4	42	55	62	67	70	66	59	48
63-2-22	68	88	96	101	103	100	93	82	100-4-7.5	64	84	92	97	99	96	89	78
63-4-1	50	70	78	83	85	82	75	64	100-4-9	63	83	91	96	98	95	88	77
63-4-1.5	48	68	76	81	83	80	73	65	100-4-10	62	82	90	95	97	94	87	76
63-4-2	52	68	76	81	83	80	73	66	100-4-15	61	81	89	94	96	93	86	75
63-4-3	53	70	78	83	85	82	77	67	100-4-20	63	83	91	96	98	95	88	77
63-4-4	54	71	79	84	86	83	78	68	100-6-3	61	72	80	85	87	84	77	66
63-4-12	52	72	80	85	87	84	77	66	100-6-4	64	72	80	85	87	84	77	66
63-4-22	53	73	81	86	88	85	78	67	100-6-5.5	64	73	81	86	88	85	78	67
63-6-0.75	42	60	68	73	75	72	65	56	100-8-2	56	66	74	79	81	78	71	60
63-6-1	43	62	70	75	77	74	67	57	100-8-3	57	68	76	81	83	80	73	62
63-8-1.5	33	53	61	66	68	65	58	50	100-8-4	58	68	76	81	83	80	73	62
63-8-2	37	53	61	66	68	65	58	51	100-8-7.5	49	69	77	82	84	81	74	63
63-8-3	38	55	63	68	70	67	62	52	100-8-9	48	68	76	81	83	80	73	62
63-8-4	39	56	64	69	71	68	63	53	100-8-15	46	66	74	79	81	78	71	60
63-12-0.75	27	43	51	56	58	55	48	37	100-8-20	47	67	75	80	82	79	72	61
63-12-1	28	45	53	58	60	57	50	42	100-12-3	46	55	63	68	70	67	60	49
71-4-1.5	54	74	82	87	89	86	79	69	100-12-4	48	55	63	68	70	67	60	49
71-4-2	53	73	81	86	88	85	78	70	100-12-5.5	49	56	64	69	71	68	61	50
71-4-3	58	72	80	85	87	84	77	71	125-4/3-9	70	76	88	98	98	94	86	82
71-4-4	59	73	81	86	88	85	78	72	125-4/3-10	70	76	88	98	98	94	86	82
71-6-0.75	44	63	72	74	76	73	66	55	125-4/3-15	71	77	89	99	99	95	87	83
71-6-1	45	65	73	75	77	74	67	56	125-4/3-20	73	79	91	101	101	97	89	85
71-6-1.5	46	66	71	76	78	75	68	57	125-4/3-25	73	79	91	101	101	97	89	85
71-8-1.5	38	58	66	71	73	70	63	54	125-4/3-27	74	80	92	102	102	98	90	86
71-8-2	38	58	66	71	73	70	63	55	125-4/3-30	74	80	92	102	102	98	90	86
71-8-3	43	57	65	70	72	69	62	56	125-4/3-37	75	81	93	103	103	99	91	87
71-8-4	44	58	66	71	73	70	63	57	125-4/3-40	75	81	93	103	103	99	91	87

## Acoustic characteristics

Sound power spectrum Lw(A) in dB(A) per Hz frequency band

Model	63	125	250	500	1000	2000	4000	8000	Model	63	125	250	500	1000	2000	4000	8000
125-6/3-5.5	66	74	86	90	88	83	74	70	140-6/6-10	69	84	93	95	92	86	78	74
125-6/3-7.5	67	75	87	91	89	84	75	71	140-6/6-15	70	85	94	96	93	87	79	75
125-6/3-10	69	77	89	93	91	86	77	73	140-6/6-20	71	86	95	97	94	88	80	76
125-6/3-15	70	78	90	94	92	87	78	74	140-6/6-25	72	87	96	98	95	89	81	77
125-6/3-20	71	79	91	95	93	88	79	75	140-6/6-30	73	88	97	99	96	90	82	78
125-6/3-24	71	79	91	95	93	88	79	75	140-6/9-10	66	84	93	92	91	87	78	73
125-8/3-9	50	56	68	78	78	74	66	62	140-6/9-15	68	86	95	94	93	89	80	75
125-8/3-15	51	57	69	79	79	75	67	63	140-6/9-20	69	87	96	95	94	90	81	76
125-8/3-20	53	59	71	81	81	77	69	65	140-6/9-25	70	88	97	96	95	91	82	77
125-8/3-27	53	59	71	81	81	77	69	65	140-6/9-30	71	89	98	97	96	92	83	78
125-8/3-37	54	60	72	82	82	78	70	66	140-6/9-40	73	91	100	99	98	94	85	80
125-8/3-40	54	60	72	82	82	78	70	66	140-6/9-50	74	92	101	100	99	95	86	81
125-6/3-4	65	73	85	89	87	82	73	69	140-8/3-3	64	74	82	87	86	85	72	67
125-12/3-4	50	58	70	74	72	67	58	54	140-8/3-4	64	74	82	87	86	85	72	67
125-12/3-5.5	51	59	71	75	73	68	59	55	140-8/6-5.5	65	75	83	88	87	86	73	68
125-12/3-7.5	52	60	72	76	74	69	60	56	140-8/6-7.5	67	77	85	90	89	88	75	70
125-12/3-10	54	62	74	78	76	71	62	58	140-8/3-10	68	78	86	91	90	89	76	71
125-12/3-15	55	63	75	79	77	72	63	59	140-8/6-3	63	75	84	88	86	80	70	67
125-12/3-24	56	64	76	80	78	73	64	60	140-8/6-4	64	76	85	89	87	81	71	68
125-4/6-20	67	75	91	98	100	95	89	85	140-8/6-5.5	65	77	86	90	88	82	72	69
125-4/6-22	67	75	91	98	100	95	89	85	140-8/6-7.5	66	78	87	91	89	83	73	70
125-4/6-25	68	76	92	99	101	96	90	86	140-8/6-10	67	79	88	92	90	84	74	71
125-4/6-27	68	76	92	99	101	96	90	86	140-8/6-15	68	80	89	93	91	85	75	72
125-4/6-30	68	76	92	99	101	96	90	86	140-8/9-4	62	73	84	89	87	83	73	68
125-4/6-37	68	76	92	99	101	96	90	86	140-8/9-5.5	62	73	84	89	87	83	73	68
125-4/6-40	70	78	94	101	103	98	92	88	140-8/9-7.5	64	75	86	91	89	85	75	70
125-4/6-50	71	79	95	102	104	99	93	89	140-8/9-10	65	76	87	92	90	86	76	71
125-6/6-5.5	60	69	82	85	86	83	72	68	140-8/9-15	66	77	88	93	91	87	77	72
125-6/6-7.5	60	69	82	85	86	83	72	68	140-8/9-20	69	80	91	96	94	90	80	75
125-6/6-10	62	71	84	87	88	85	74	70	160-6/3-10	69	79	87	92	91	90	77	72
125-6/6-15	64	73	86	89	90	87	76	72	160-6/3-15	71	81	89	94	93	92	79	74
125-6/6-20	65	74	87	90	91	88	77	73	160-6/6-20	72	82	90	95	94	93	80	75
125-6/6-24	65	74	87	90	91	88	77	73	160-6/6-25	73	83	91	96	95	94	81	76
125-8/6-20	46	54	70	77	79	74	68	64	160-6/6-30	75	85	93	98	97	96	83	78
125-8/6-22	47	55	71	78	80	75	69	65	160-6/6-15	69	84	93	95	92	86	78	74
125-8/6-27	47	55	71	78	80	75	69	65	160-6/6-20	70	85	94	96	93	87	79	75
125-8/6-37	48	56	72	79	81	76	70	66	160-6/6-25	71	86	95	97	94	88	80	76
125-8/6-40	49	57	73	80	82	77	71	67	160-6/6-30	72	87	96	98	95	89	81	77
125-12/6-5.5	45	54	67	70	71	68	57	53	160-6/6-40	73	88	97	99	96	90	82	78
125-12/6-7.5	45	54	67	70	71	68	57	53	160-6/6-50	75	90	99	101	98	92	84	80
125-12/6-10	47	56	69	72	73	70	59	55	160-6/9-15	67	85	94	93	92	88	79	74
125-12/6-15	49	58	71	74	75	72	61	57	160-6/9-20	68	86	95	94	93	89	80	75
125-12/6-24	50	59	72	75	76	73	62	58	160-6/9-25	69	87	96	95	94	90	81	76
125-4/9-22	66	74	91	97	98	93	88	84	160-6/9-30	70	88	97	96	95	91	82	77
125-4/9-25	66	74	91	97	98	93	88	84	160-6/9-40	71	89	98	97	96	92	83	78
125-4/9-27	67	75	92	98	99	94	89	85	160-6/9-50	72	90	99	98	97	93	84	79
125-4/9-30	67	75	92	98	99	94	89	85	160-6/9-60	73	91	100	99	98	94	85	80
125-4/9-37	68	76	93	99	100	95	90	86	160-6/9-75	74	92	101	100	99	95	86	81
125-4/9-40	69	77	94	100	101	96	91	87	160-8/3-4	63	73	81	86	85	84	71	66
125-4/9-50	71	79	96	102	103	98	93	89	160-8/3-5.5	65	75	83	88	87	86	73	68
125-6/9-10	58	68	83	87	86	85	74	70	160-8/3-7.5	66	76	84	89	88	87	74	69
125-6/9-15	61	71	86	90	89	88	77	73	160-8/3-10	67	77	85	90	89	88	75	70
125-6/9-20	64	74	89	93	92	91	80	76	160-8/3-15	69	79	87	92	91	90	77	72
125-6/9-24	64	74	89	93	92	91	80	76	160-8/6-5.5	61	76	85	87	84	78	70	66
125-8/9-22	47	55	72	78	79	74	69	65	160-8/6-7.5	63	78	87	89	86	80	72	68
125-8/9-27	48	56	73	79	80	75	70	66	160-8/6-10	64	79	88	90	87	81	73	69
125-8/9-37	48	56	73	79	80	75	70	66	160-8/6-15	66	81	90	92	89	83	75	71
125-8/9-40	49	57	74	80	81	76	71	67	160-8/6-20	67	82	91	93	90	84	76	72
125-12/9-10	43	53	68	72	71	70	59	55	160-8/6-25	68	83	92	94	91	85	77	73
125-12/9-15	46	56	71	75	74	73	62	58	160-8/9-7.5	61	79	88	87	86	82	73	68
125-12/9-24	49	59	74	78	77	76	65	61	160-8/9-10	62	80	89	88	87	83	74	69
140-6/3-5.5	69	79	87	92	91	90	77	77	160-8/9-15	64	82	91	90	89	85	76	71
140-6/3-7.5	70	80	88	93	92	91	78	78	160-8/9-20	65	83	92	91	90	86	77	72
140-6/3-10	71	81	89	94	93	92	79	79	160-8/9-25	66	84	93	92	91	87	78	73
140-6/3-15	72	82	90	95	94	93	80	80	160-8/9-30	67	85	94	93	92	88	79	74
140-6/3-20	74	84	92	97	96	95	82	82	160-8/9-40	68	86	95	94	93	89	80	75
140-6/6-7.5	68	83	92	94	91	85	77	73									

## Accessories



INT

IAT

CABLE BOX

C2V

AET

CENTRAL CO

VSD3/A-RFT

P-400

R

RI

Dimensions mm

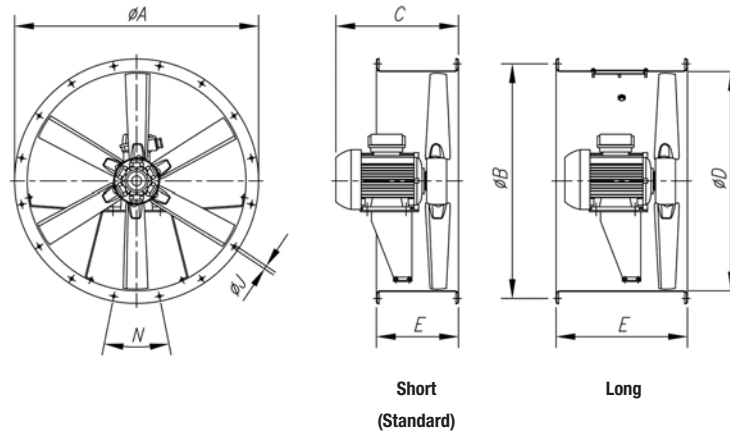

C (Consult motor size, depending on power)

Model	ØA	ØB	C																ØD	E		ØJ	N
			80	90S	90L	100	112	132S	132M	132ML	160M	160L	180M	180L	200L	225	250	280		Short	Long		
THT-40	490	450	348	364	389	-	-	-	-	-	-	-	-	-	-	-	-	-	410	250	400	12	8x45°
THT-45	540	500	348	364	389	-	-	-	-	-	-	-	-	-	-	-	-	-	460	250	400	12	8x45°
THT-50	600	560	339	364	389	-	-	-	-	-	-	-	-	-	-	-	-	-	514	250	400	12	12x30°
THT-50	600	560	-	-	-	419	438	-	-	-	-	-	-	-	-	-	-	-	514	250	500	12	12x30°
THT-56	660	620	275	364	389	-	-	-	-	-	-	-	-	-	-	-	-	-	560	250	400	12	12x30°
THT-56	660	620	-	-	-	416	432	480	518	-	-	-	-	-	-	-	-	-	560	250	500	12	12x30°
THT-56	660	620	-	-	-	-	-	-	-	620	-	-	-	-	-	-	-	-	560	250	650	12	12x30°
THT-63	730	690	339	359	389	-	-	-	-	-	-	-	-	-	-	-	-	-	640	250	400	12	12x30°
THT-63	730	690	-	-	-	420	437	-	-	-	-	-	-	-	-	-	-	-	640	250	500	12	12x30°
THT-63	730	690	-	-	-	-	-	539	577	-	-	-	-	-	-	-	-	-	640	250	650	12	12x30°
THT-63	730	690	-	-	-	-	-	-	-	630	674	-	-	-	-	-	-	-	640	350	650	12	12x30°
THT-71	810	770	366	379	404	-	-	-	-	-	-	-	-	-	-	-	-	-	710	300	430	12	16x22°30'
THT-71	810	770	-	-	-	438	433	-	-	-	-	-	-	-	-	-	-	-	710	300	500	12	16x22°30'
THT-80	900	860	-	-	422	456	472	-	-	-	-	-	-	-	-	-	-	-	800	300	500	12	16x22°30'
THT-80	900	860	-	-	-	-	-	515	-	-	-	-	-	-	-	-	-	-	800	300	600	12	16x22°30'
THT-90	1015	970	-	-	-	466	482	525	565	590	-	-	-	-	-	-	-	-	900	350	600	15	16x22°30'
THT-100	1115	1070	-	-	-	-	482	525	565	590	-	-	-	-	-	-	-	-	1000	450	600	15	16x22°30'
THT-100	1115	1070	-	-	-	-	-	-	-	-	695	695	-	-	-	-	-	-	1000	450	700	15	16x22°30'
THT-125	1365	1320	-	-	-	-	-	561	601	-	-	-	-	-	-	-	-	-	1250	500	700	15	20x18°
THT-125	1365	1320	-	-	-	-	-	-	-	626	695	695	-	-	-	-	-	-	1250	500	700	15	20x18°
THT-125	1365	1320	-	-	-	-	-	-	-	-	-	740	740	860	-	-	-	-	1250	500	900	15	20x18°
THT-125	1365	1320	-	-	-	-	-	-	-	-	-	-	-	-	907	-	-	-	1250	500	1000	15	20x18°
THT-125	1365	1320	-	-	-	-	-	-	-	-	-	-	-	-	-	987	-	-	1250	600	1000	15	20x18°
THT-125	1365	1320	-	-	-	-	-	-	-	-	-	-	-	-	-	-	1077	-	1250	600	1200	15	20x18°
THT-140	1515	1470	-	-	-	-	532	570	-	-	-	-	-	-	-	-	-	-	1400	400	650	15	20x18°
THT-140	1515	1470	-	-	-	-	-	-	-	650	700	-	-	-	-	-	-	-	1400	450	700	15	20x18°
THT-140	1515	1470	-	-	-	-	-	-	-	-	-	765	-	-	-	-	-	-	1400	550	900	15	20x18°
THT-140	1515	1470	-	-	-	-	-	-	-	-	-	-	825	-	-	-	-	-	1400	550	900	15	20x18°
THT-140	1515	1470	-	-	-	-	-	-	-	-	-	-	-	910	-	-	-	-	1400	550	1000	15	20x18°
THT-140	1515	1470	-	-	-	-	-	-	-	-	-	-	-	-	985	-	-	-	1400	600	1000	15	20x18°
THT-160	1735	1680	-	-	-	-	532	570	-	-	-	-	-	-	-	-	-	-	1600	400	650	19	24x15°
THT-160	1735	1680	-	-	-	-	-	-	-	-	700	-	-	-	-	-	-	-	1600	450	700	19	24x15°
THT-160	1735	1680	-	-	-	-	-	-	-	-	-	765	-	-	-	-	-	-	1600	550	900	19	24x15°
THT-160	1735	1680	-	-	-	-	-	-	-	-	-	-	825	-	-	-	-	-	1600	550	1000	19	24x15°
THT-160	1735	1680	-	-	-	-	-	-	-	-	-	-	-	910	-	-	-	-	1600	550	1000	19	24x15°
THT-160	1735	1680	-	-	-	-	-	-	-	-	-	-	-	-	985	-	-	-	1600	600	1000	19	24x15°
THT-160	1735	1680	-	-	-	-	-	-	-	-	-	-	-	-	-	1190	-	-	1600	700	1000	19	24x15°

\* Standard version supplied with short casing. Long casing with inspection hatch available on request.

Motor construction sizes, depending on power (1 speed)

	hp																			
	0.75	1	1.5	2	3	4	5.5	7.5	10	12	15	20	22	25	30	40	50	60	75	100
2T (3000 r/min)	80	80	80	90S	90L	100LB	112M	132S	132S	132MA	160M	160M	160L	180M	180L	200L	225S/M	225S/M	250S/M	280S/M
4T (1500 r/min)	90S	90S	90S	90L	100LA	100LB	112M	132S	132M	-	160M	160L	-	180M	180L	200L	225S/M	225S/M	250S/M	280S/M
6T (1000 r/min)	90S	90S	90L	100L	112M	132S	132MA	132MB	160M	-	160L	180L	-	200MLA	200MLB	225SMB	250S/M	280S/M	280S/M	-
8T (750 r/min)	90L	100LA	100L	112M	132S	132M	160MA	160M	160L	-	180L	200MLA	-	225SMA	225SMB	250SMA	280S/M	280S/M	-	-

Motor construction sizes, depending on power (2 speed)

	hp																						
	0.75	1	1.5	2	3	4	5.5	6	7.5	8	9	10	12	15	18	20	22	24	27	37	38	40	
2/4(3000/1500 r/min)	-	-	90S	90S	90L	100L	-	112M	-	-	132M	-	160MA	-	160M	-	160L	-	-	-	-	-	-
4/8(1500/750 r/min)	-	-	90S	100L	100LA	100LC	132S	-	132S	132S	-	132M	-	160M	-	160L	180M	180L	200MLA	200L	225S/M	-	
6/12(1000/500 r/min)	90L	100L	100LB	112M	112M	132MC	160M	160M	160LB	160LB	-	160LB	-	200MLC	160L	200M	-	250SMB	22S/M	-	225S/M	-	

## SELECTION EXAMPLE

### Characteristic curves

THT CJTHT

Q= Flow rate in m<sup>3</sup>/h, m<sup>3</sup>/s and cfm.Pe= Static pressure in mmH<sub>2</sub>O, Pa and inwg.

Rotor diameter (cm): 71

Number of poles: 6

Number of blades: 6

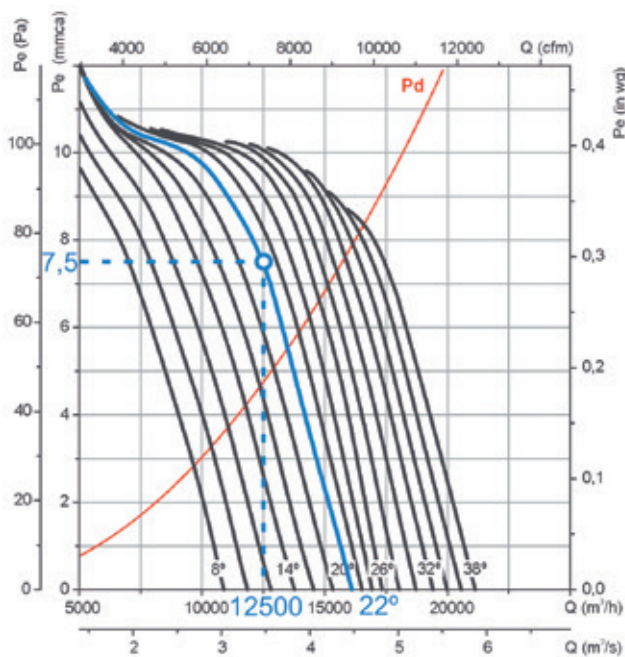

### Starting data

- Working point:
- Flow rate: 12,500 m<sup>3</sup>/h
- Load loss: 7.5 mm c.a.

### Equipment selection steps

#### On the pressure graph:

1. Mark the working point defined by the flow rate (12,500 m<sup>3</sup>/h) and the load loss (7.5 mm H<sub>2</sub>O).
2. Select the nearest equipment curve above the working point. In this case, a blade angle curve of 22° is obtained.

#### On the power graph:

3. Mark the working point defined by the working flow rate (12,500 m<sup>3</sup>/h) and the selected blade angle curve (22°).
4. Read the absorbed power on the left power axis. Pa= 560 W at the working point.
5. Find the nearest straight red line above the working point. The installed motor power is given on the right side of the graph. In this case, 0.75 kW or 1 hp.

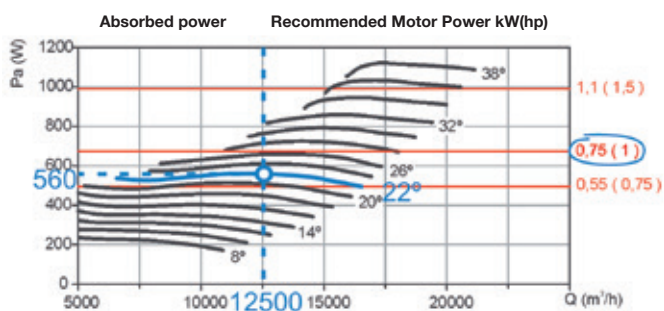

## ORDER CODE EXAMPLE

THT	—	40	—	4T	—	2	—	6-20	—	F-400				
Serial name: THT CJTHT		Rotor diameter in cm		Number of motor poles 2=3500 r/min. 60 Hz 4=1680 r/min. 60 Hz 6=1080 r/min. 60 Hz 8=900 r/min. 60 Hz 12=750 r/min. 60 Hz		T= Three-phase M=Single-phase		Motor power (hp)		Number of blades 3 blades 6 blades 9 blades		Blade in- clination angle		F-300: 300 °C/2h approved F-400: 400 °C/2h approved CAT3: With ATEX Category 3 Ex II3G certification



**Characteristic curves**

Q= Flow rate in m<sup>3</sup>/h, m<sup>3</sup>/s and cfm.

Pe= Static pressure in mm H<sub>2</sub>O, Pa and inwg.

**Rotor diameter (cm): 40**

**Number of poles: 2**

**Number of blades: 6**

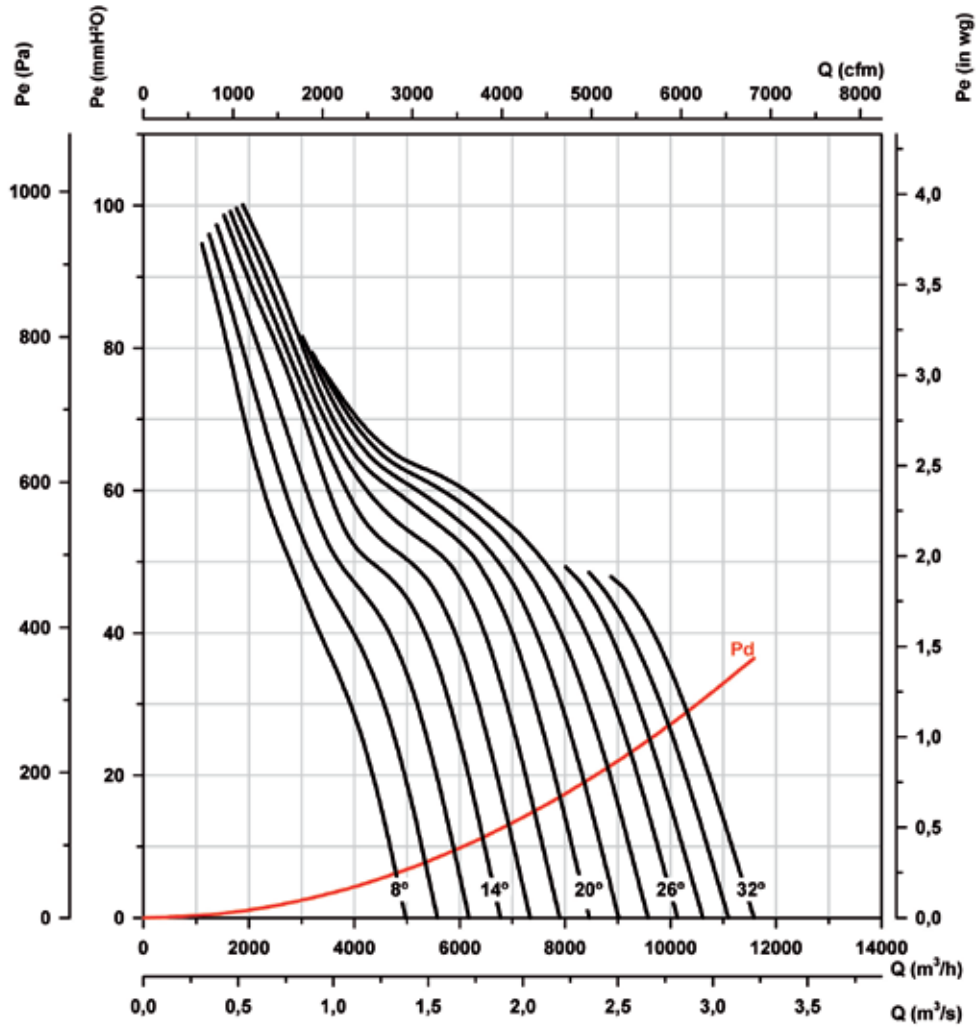

Absorbed power

Recommended Motor Power kW(hp)

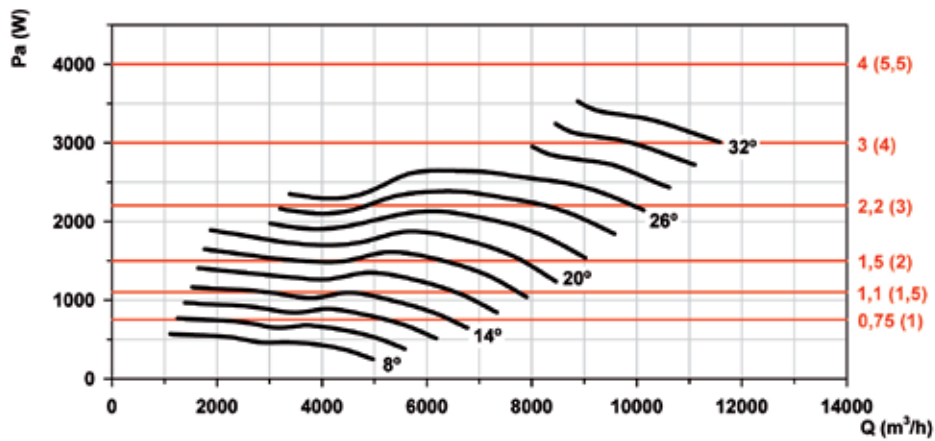

**Characteristic curves**

Q= Flow rate in m<sup>3</sup>/h, m<sup>3</sup>/s and cfm.

Pe= Static pressure in mm H<sub>2</sub>O, Pa and inwg.

**Rotor diameter (cm): 40**

**Number of poles: 4**

**Number of blades: 6**

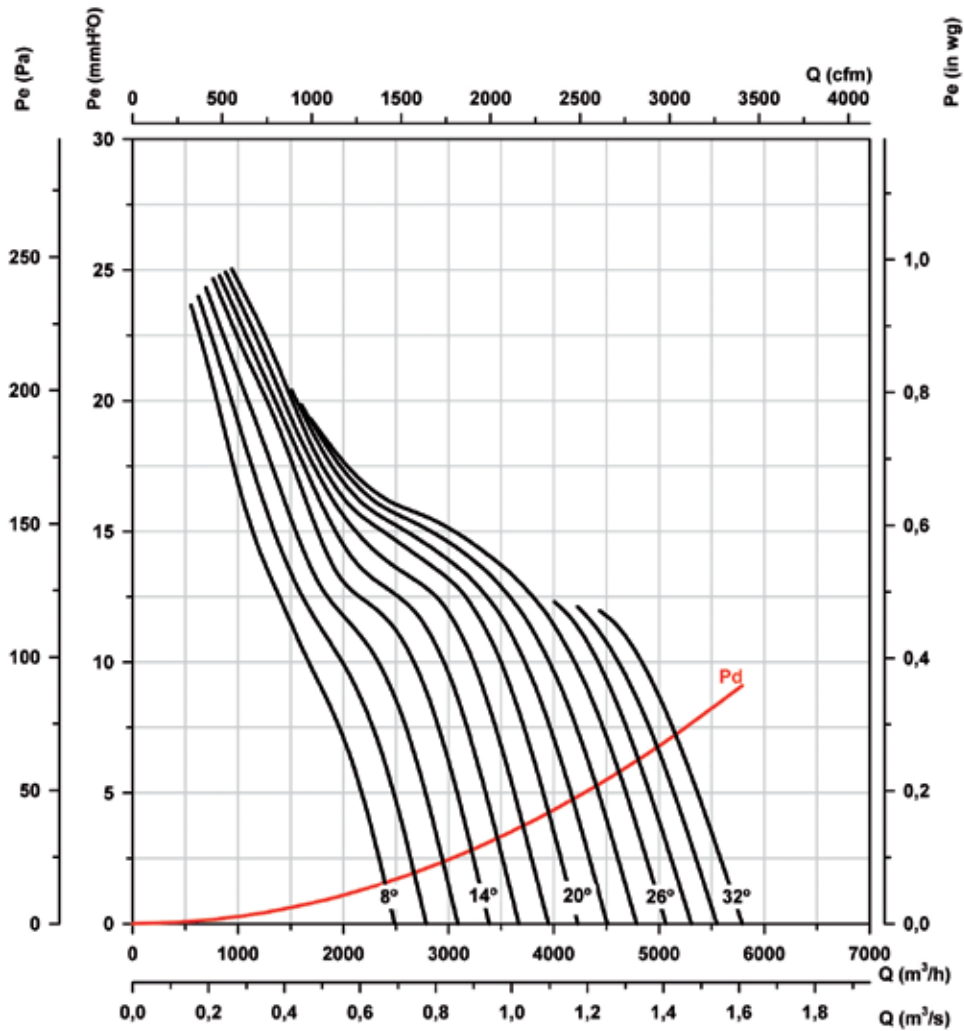

Absorbed power

Recommended Motor Power kW(hp)

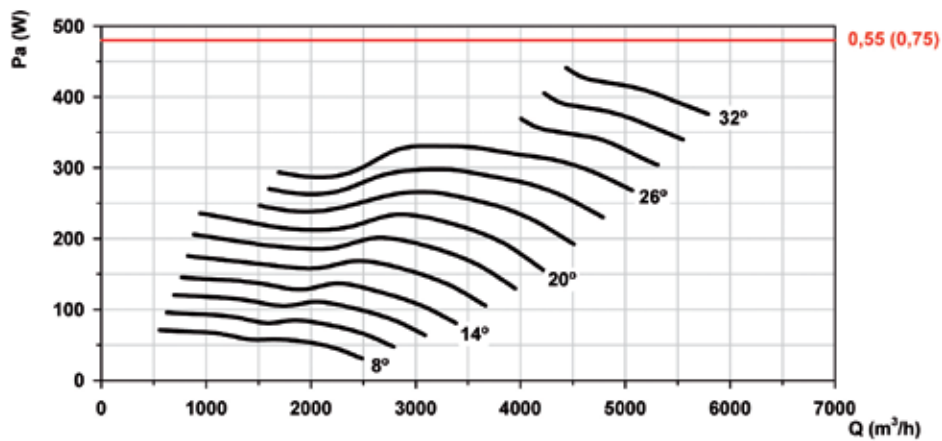

**Characteristic curves**

Q= Flow rate in m<sup>3</sup>/h, m<sup>3</sup>/s and cfm.

Pe= Static pressure in mm H<sub>2</sub>O, Pa and inwg.

**Rotor diameter (cm): 40**

**Number of poles: 6**

**Number of blades: 6**

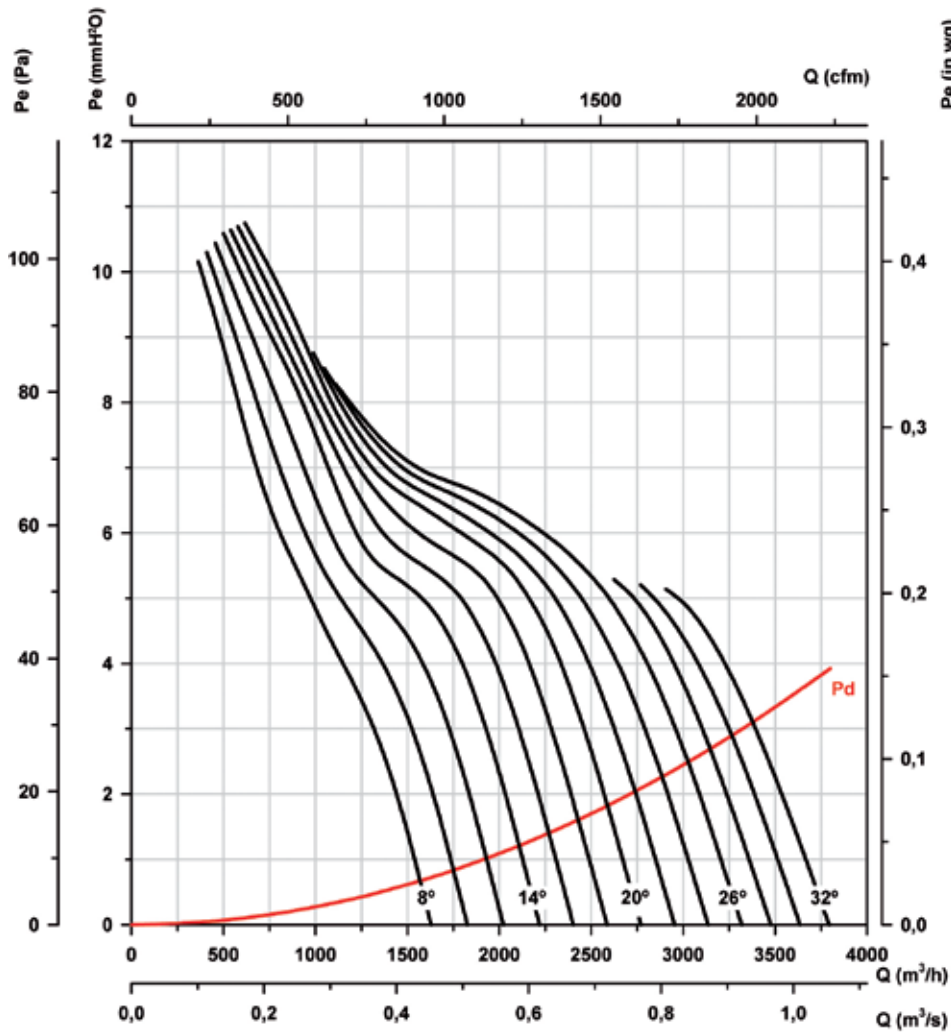

Absorbed power

Recommended Motor Power kW(hp)

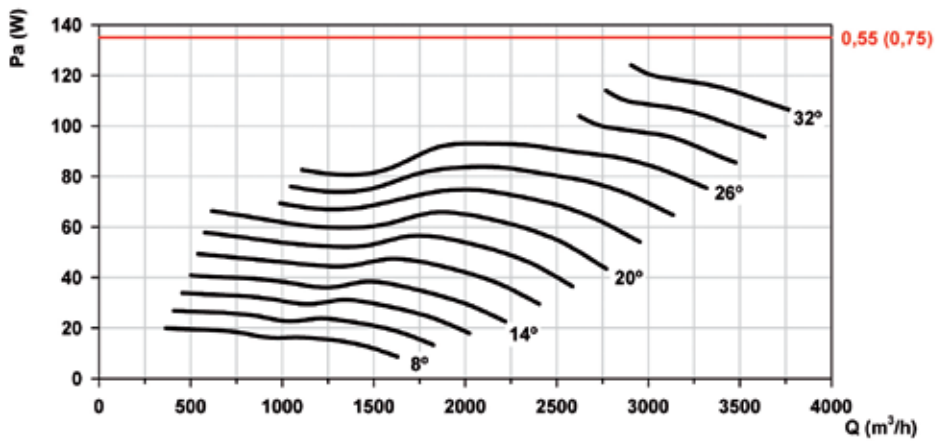

**Characteristic curves**

Q= Flow rate in m<sup>3</sup>/h, m<sup>3</sup>/s and cfm.

Pe= Static pressure in mm H<sub>2</sub>O, Pa and inwg.

**Rotor diameter (cm): 45**

**Number of poles: 2**

**Number of blades: 6**

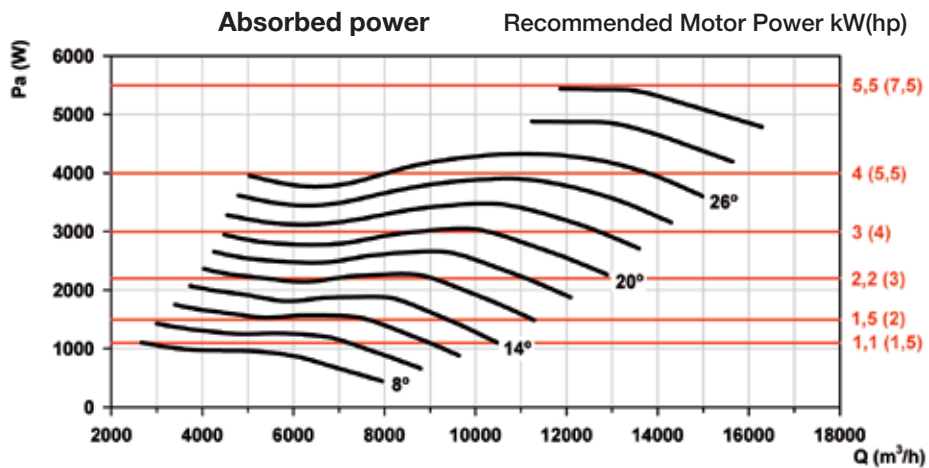
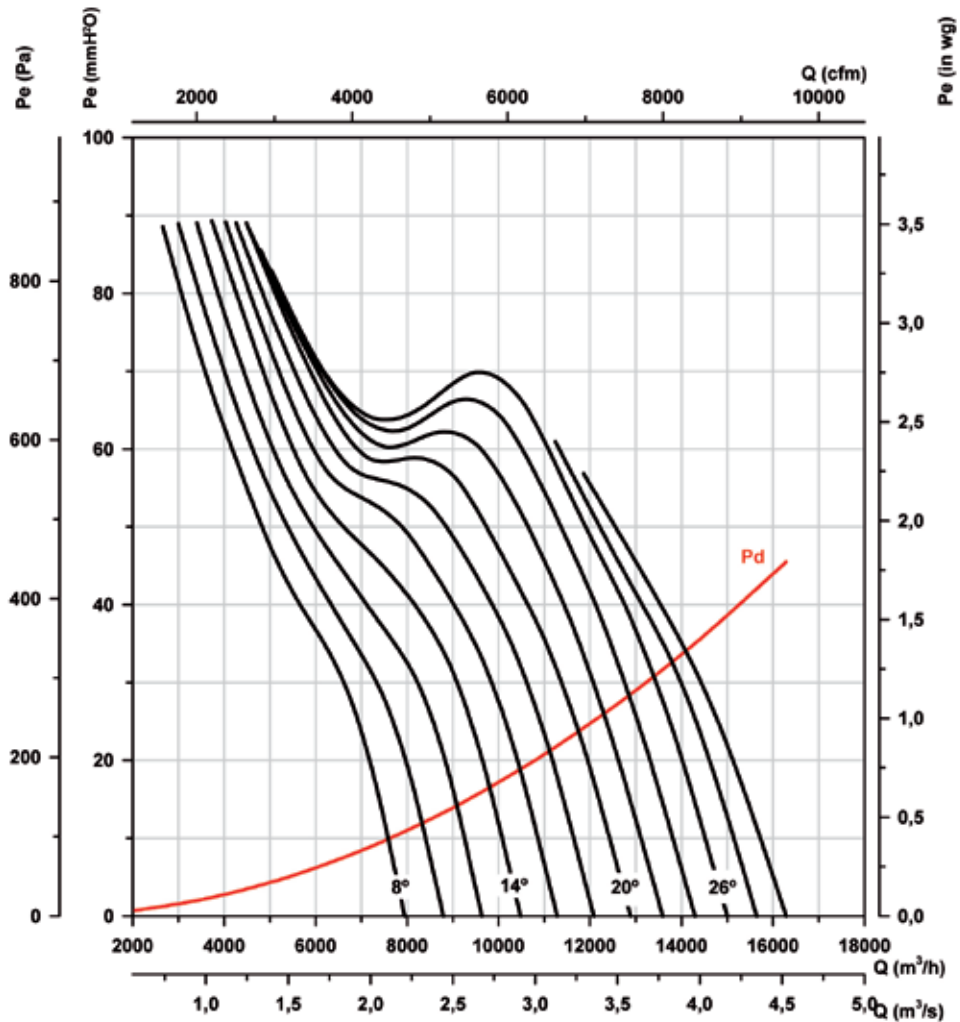

**Characteristic curves**

Q= Flow rate in m<sup>3</sup>/h, m<sup>3</sup>/s and cfm.

Pe= Static pressure in mm H<sub>2</sub>O, Pa and inwg.

**Rotor diameter (cm): 45**

**Number of poles: 4**

**Number of blades: 6**

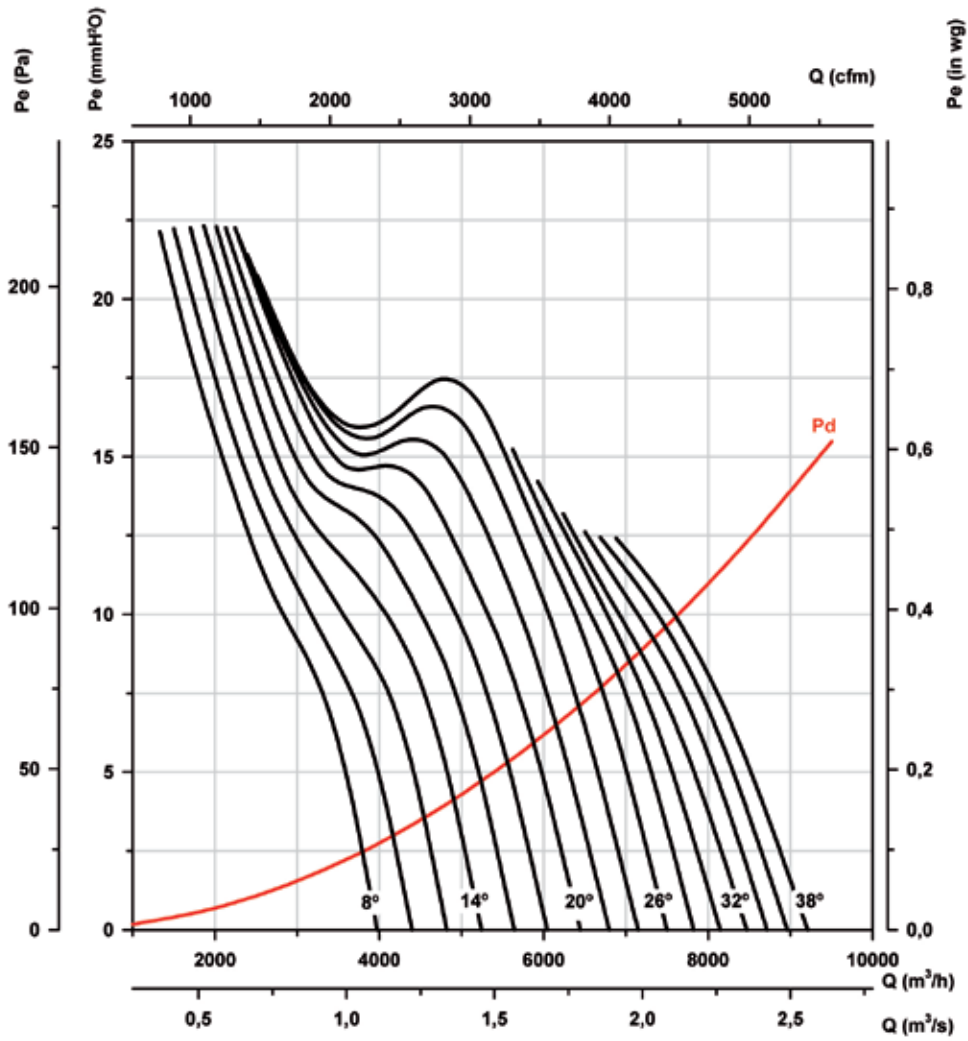

**Absorbed power**

**Recommended Motor Power kW(hp)**

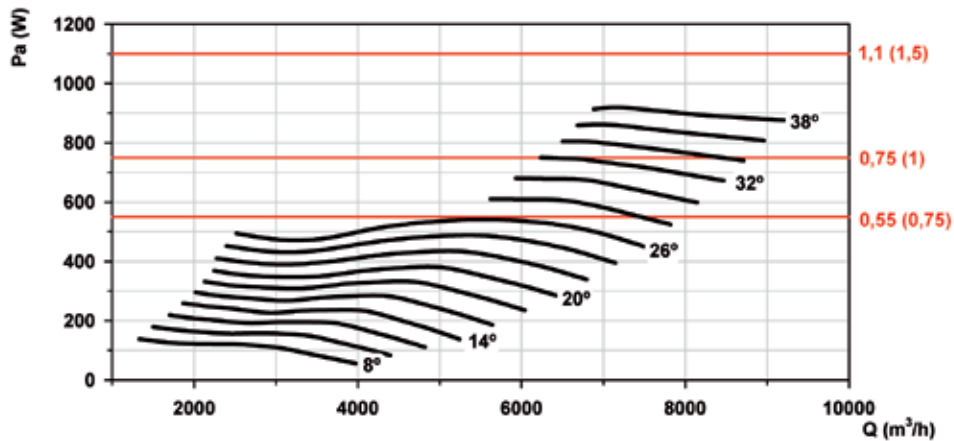

**Characteristic curves**

Q= Flow rate in m<sup>3</sup>/h, m<sup>3</sup>/s and cfm.

Pe= Static pressure in mm H<sub>2</sub>O, Pa and inwg.

**Rotor diameter (cm): 45**

**Number of poles: 6**

**Number of blades: 6**

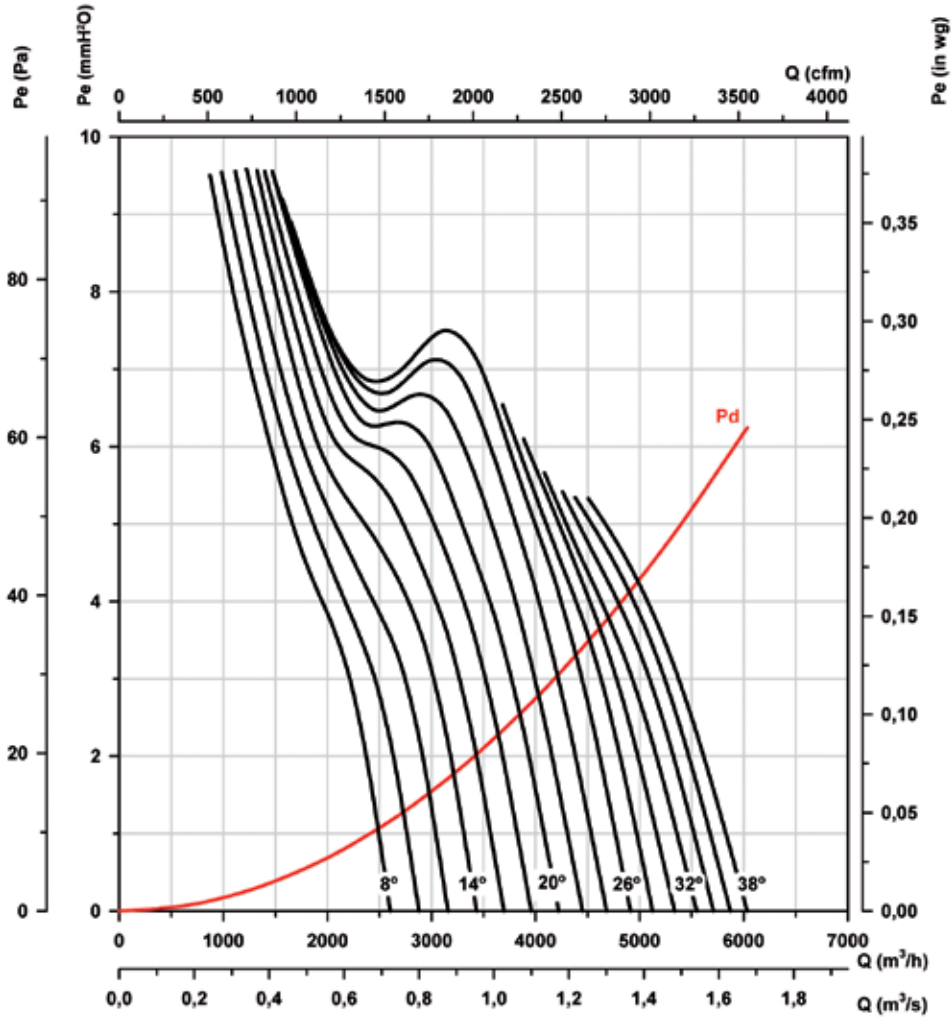

Absorbed power

Recommended Motor Power kW(hp)

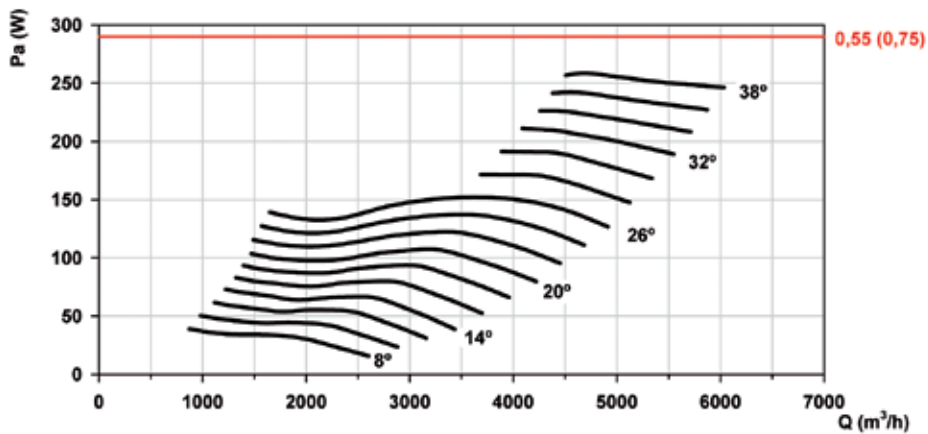

**Characteristic curves**

Q= Flow rate in m<sup>3</sup>/h, m<sup>3</sup>/s and cfm.

Pe= Static pressure in mm H<sub>2</sub>O, Pa and inwg.

**Rotor diameter (cm): 50**

**Number of poles: 2**

**Number of blades: 6**

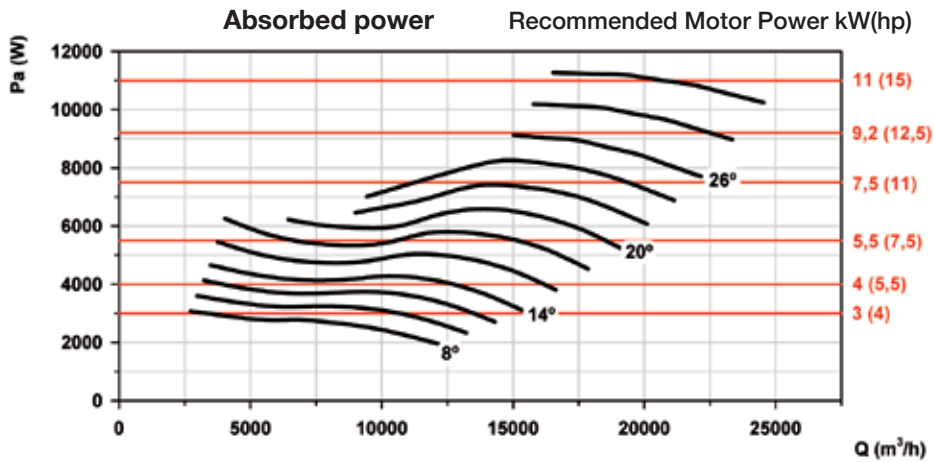
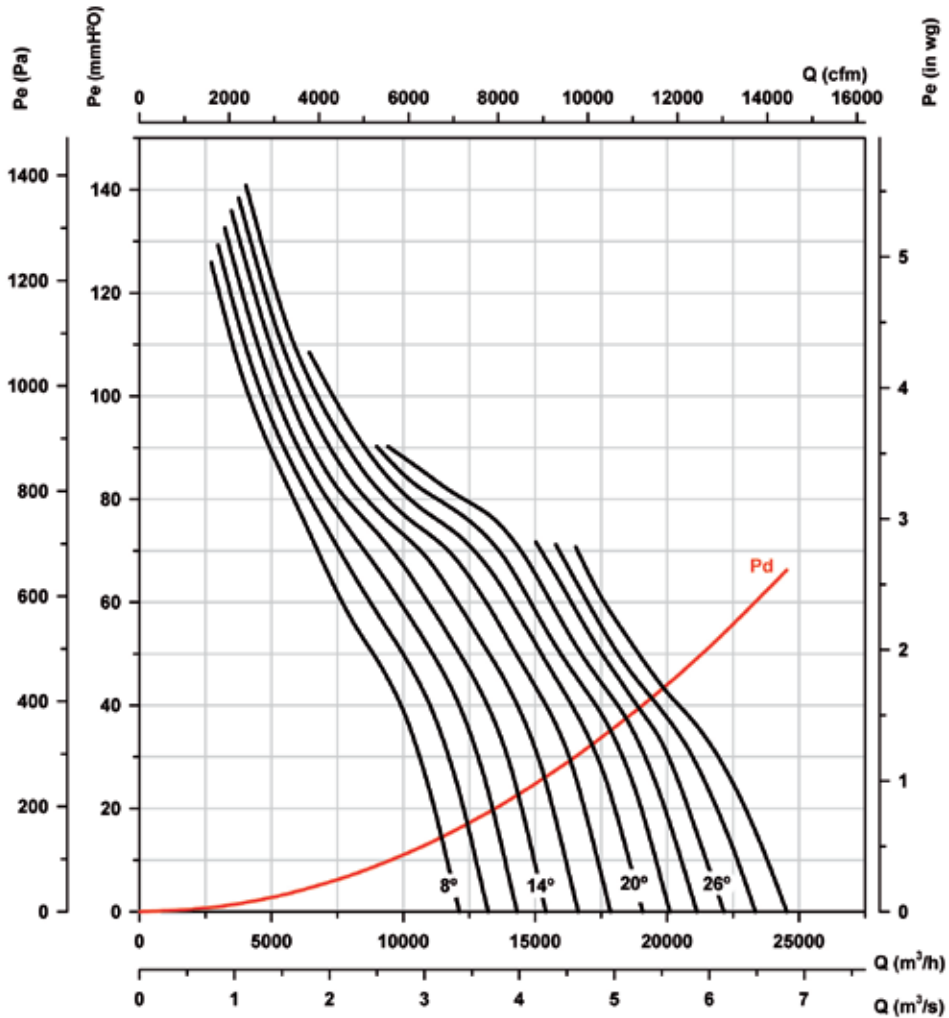

**Characteristic curves**

Q= Flow rate in m<sup>3</sup>/h, m<sup>3</sup>/s and cfm.

Pe= Static pressure in mm H<sub>2</sub>O, Pa and inwg.

**Rotor diameter (cm): 50**

**Number of poles: 4**

**Number of blades: 6**

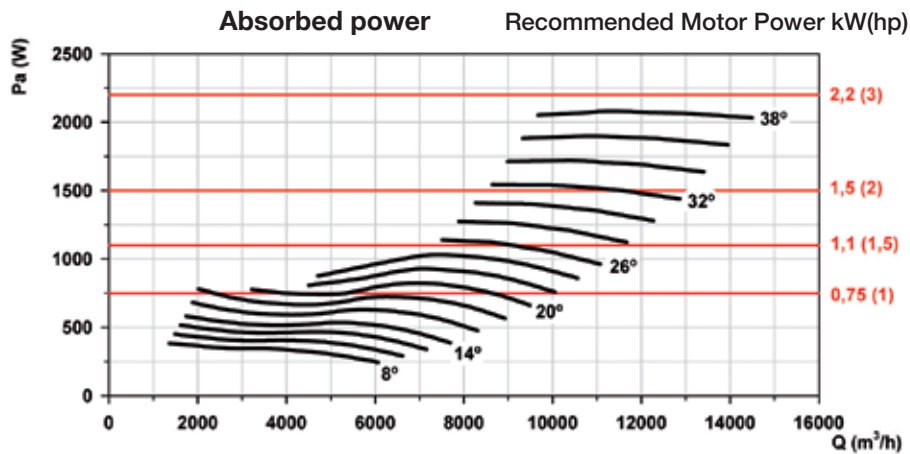
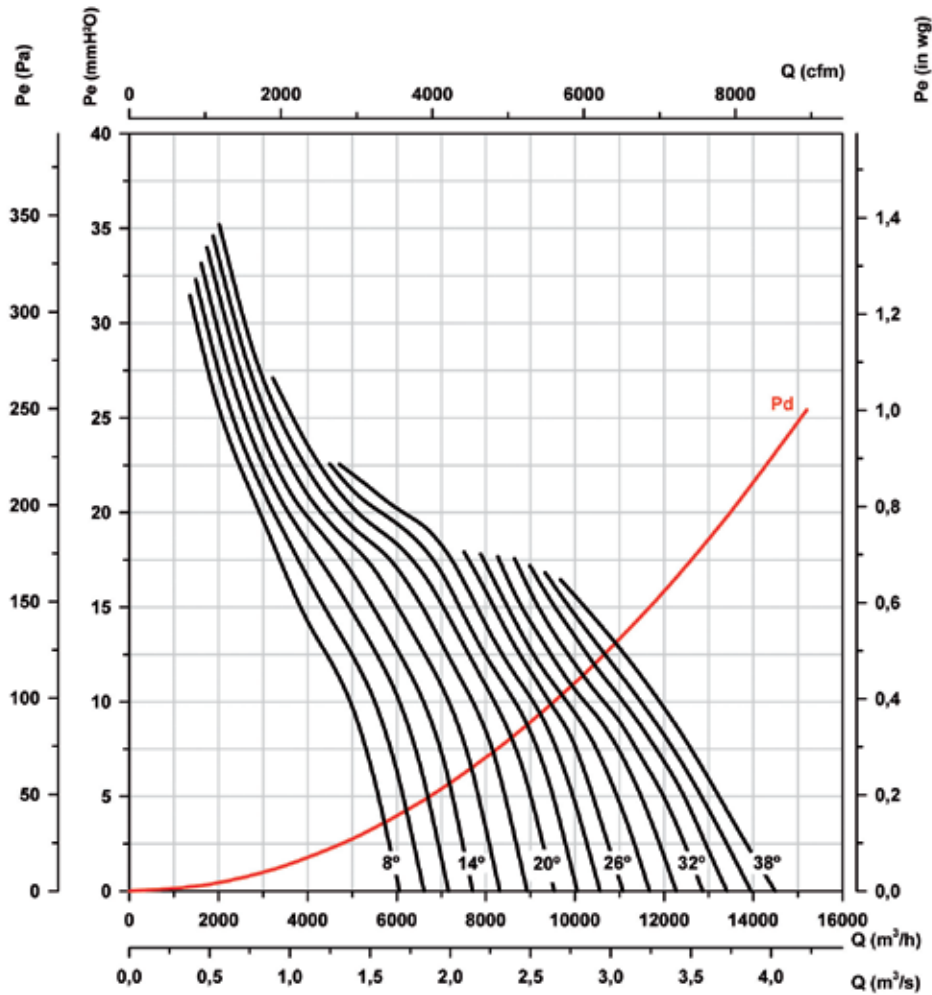



**Characteristic curves**

Q= Flow rate in m<sup>3</sup>/h, m<sup>3</sup>/s and cfm.

Pe= Static pressure in mm H<sub>2</sub>O, Pa and inwg.

**Rotor diameter (cm): 50**

**Number of poles: 6**

**Number of blades: 6**

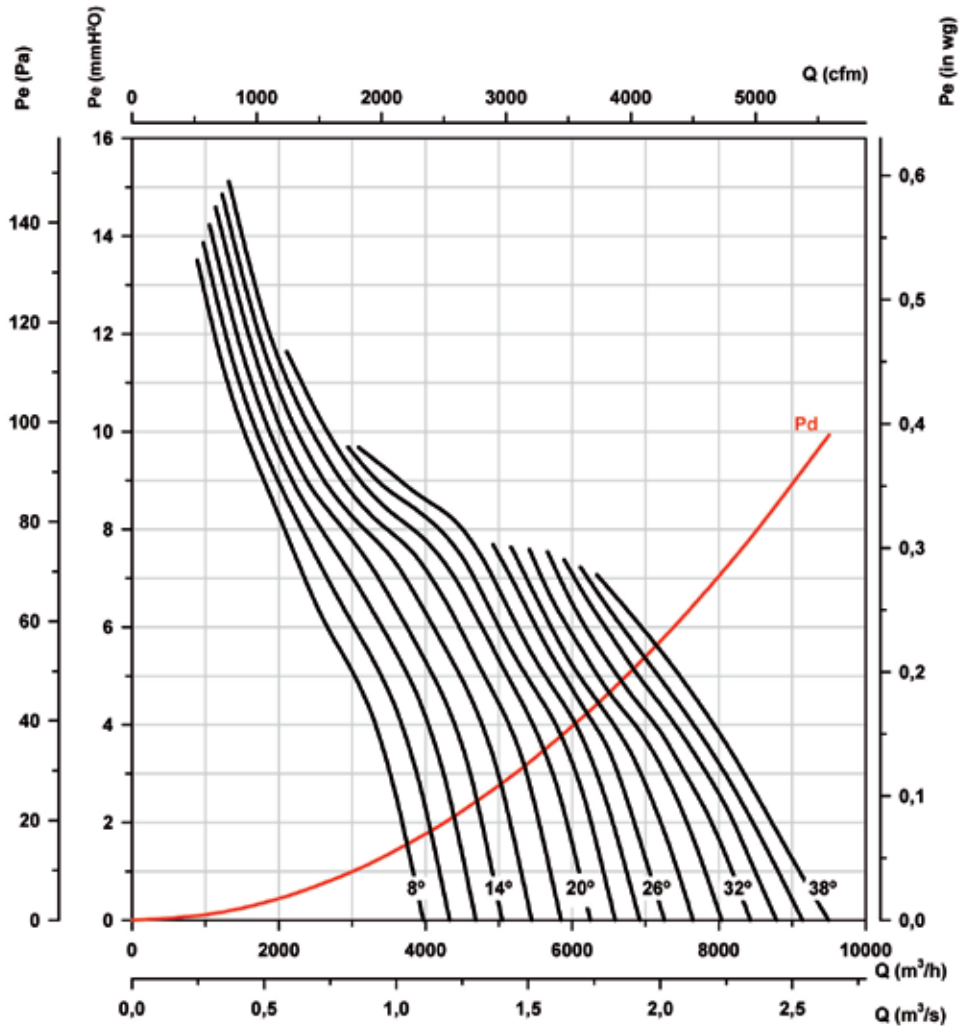

Absorbed power

Recommended Motor Power kW(hp)

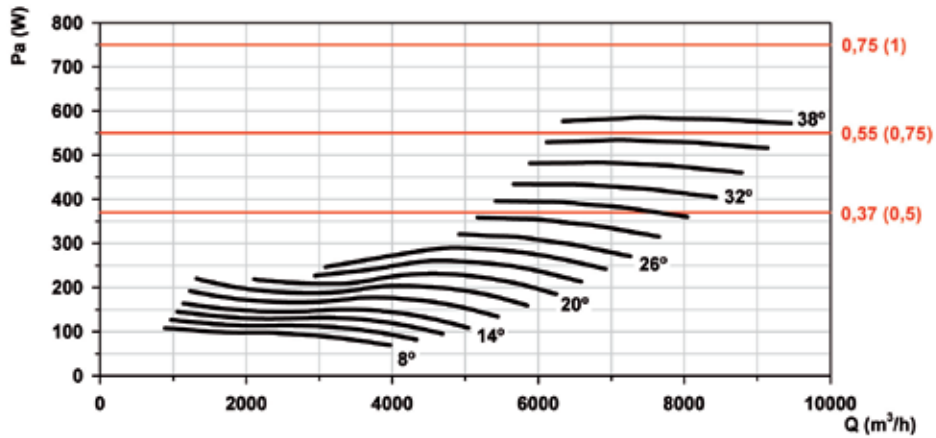

**Characteristic curves**

Q= Flow rate in m<sup>3</sup>/h, m<sup>3</sup>/s and cfm.

Pe= Static pressure in mm H<sub>2</sub>O, Pa and inwg.

**Rotor diameter (cm): 56**

**Number of poles: 2**

**Number of blades: 6**

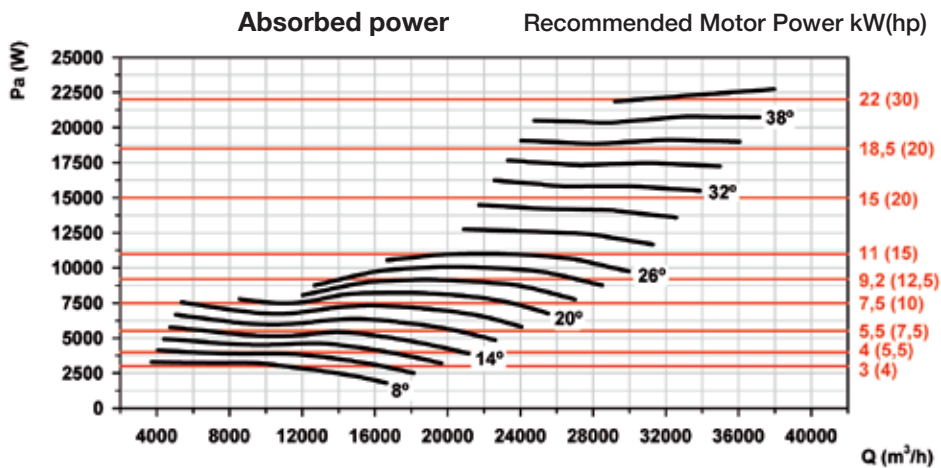
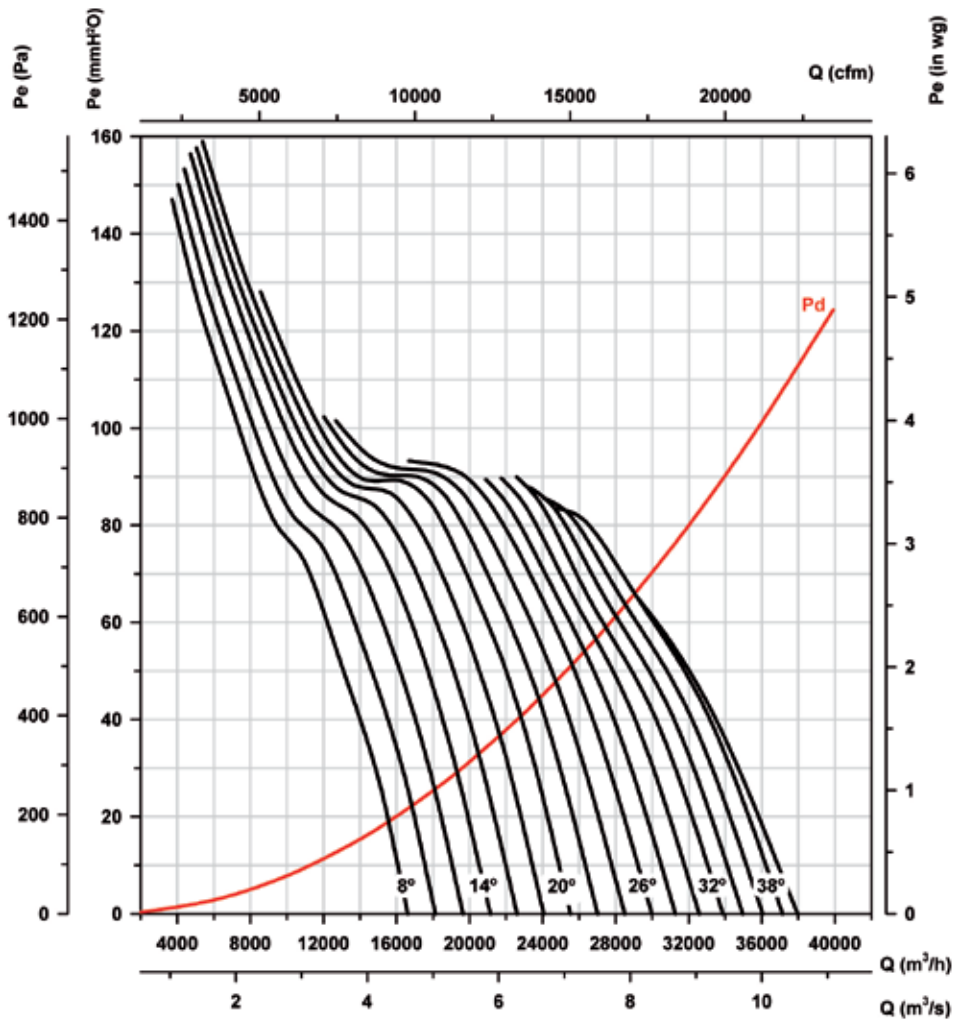

**Characteristic curves**

Q= Flow rate in m<sup>3</sup>/h, m<sup>3</sup>/s and cfm.

Pe= Static pressure in mm H<sub>2</sub>O, Pa and inwg.

**Rotor diameter (cm): 56**

**Number of poles: 4**

**Number of blades: 6**

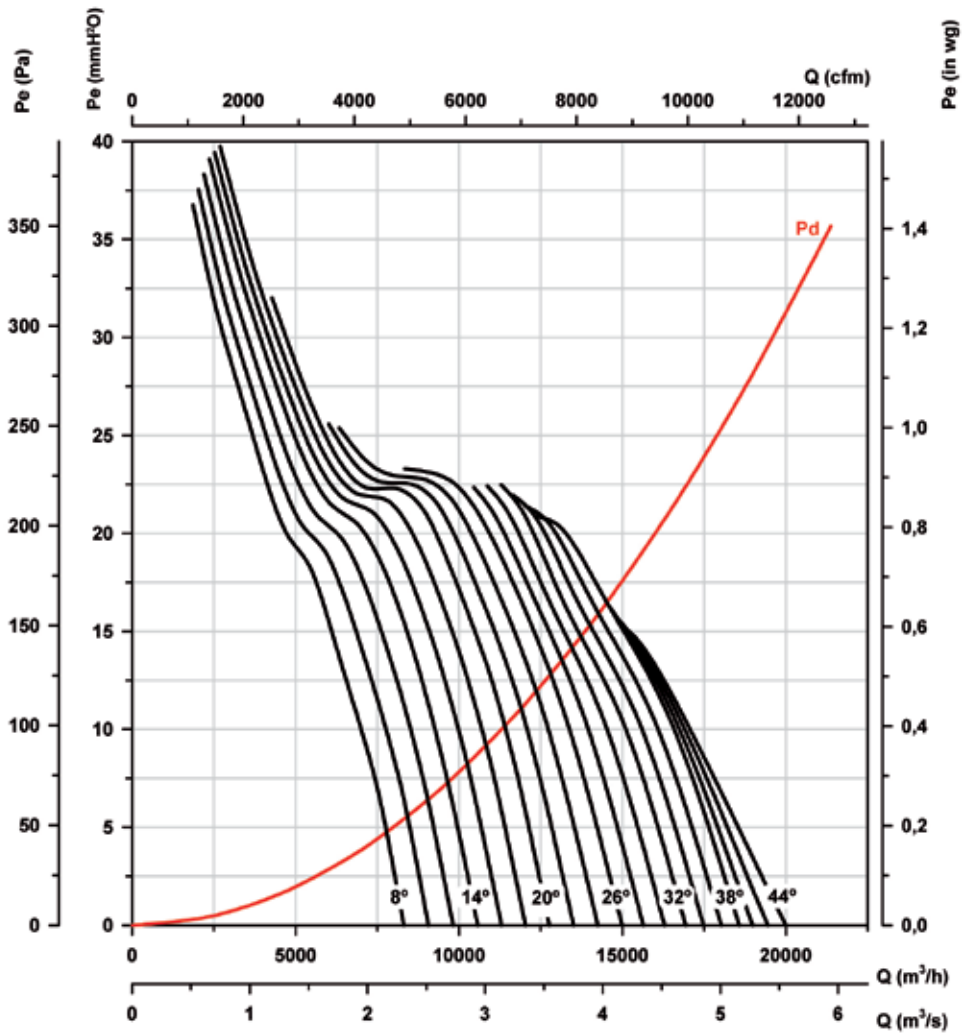

**Absorbed power**

**Recommended Motor Power kW(hp)**

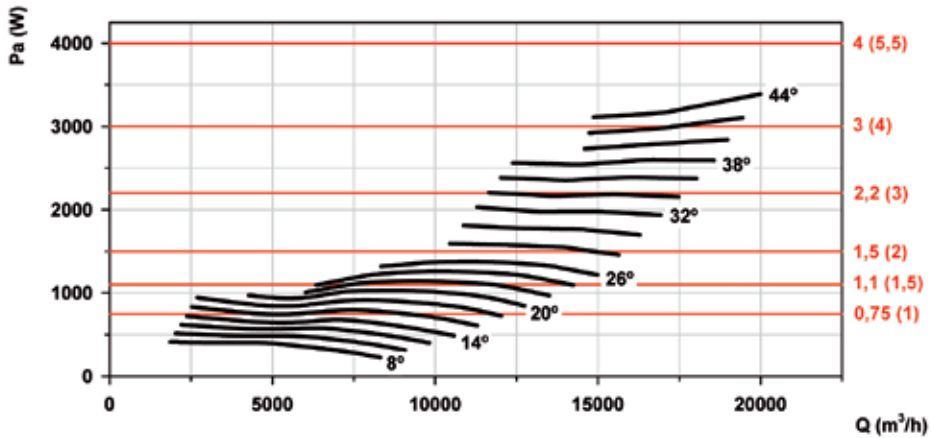

**Characteristic curves**

Q= Flow rate in m<sup>3</sup>/h, m<sup>3</sup>/s and cfm.

Pe= Static pressure in mm H<sub>2</sub>O, Pa and inwg.

**Rotor diameter (cm): 56**

**Number of poles: 6**

**Number of blades: 6**

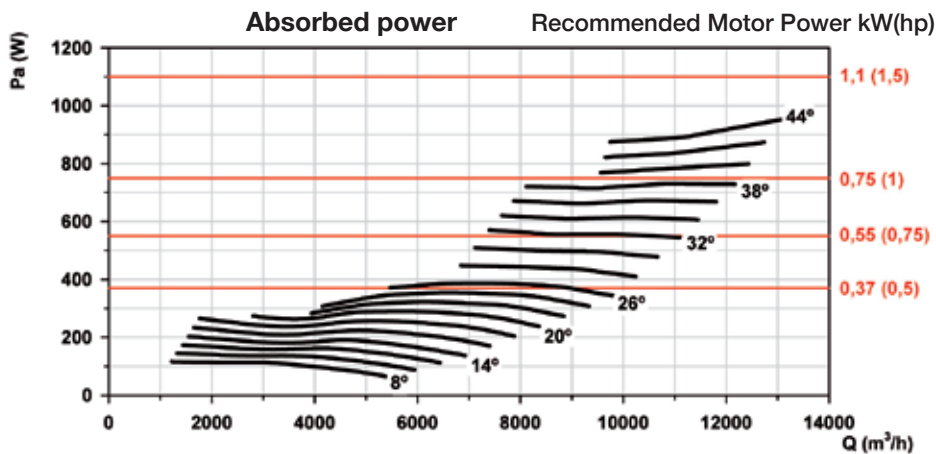
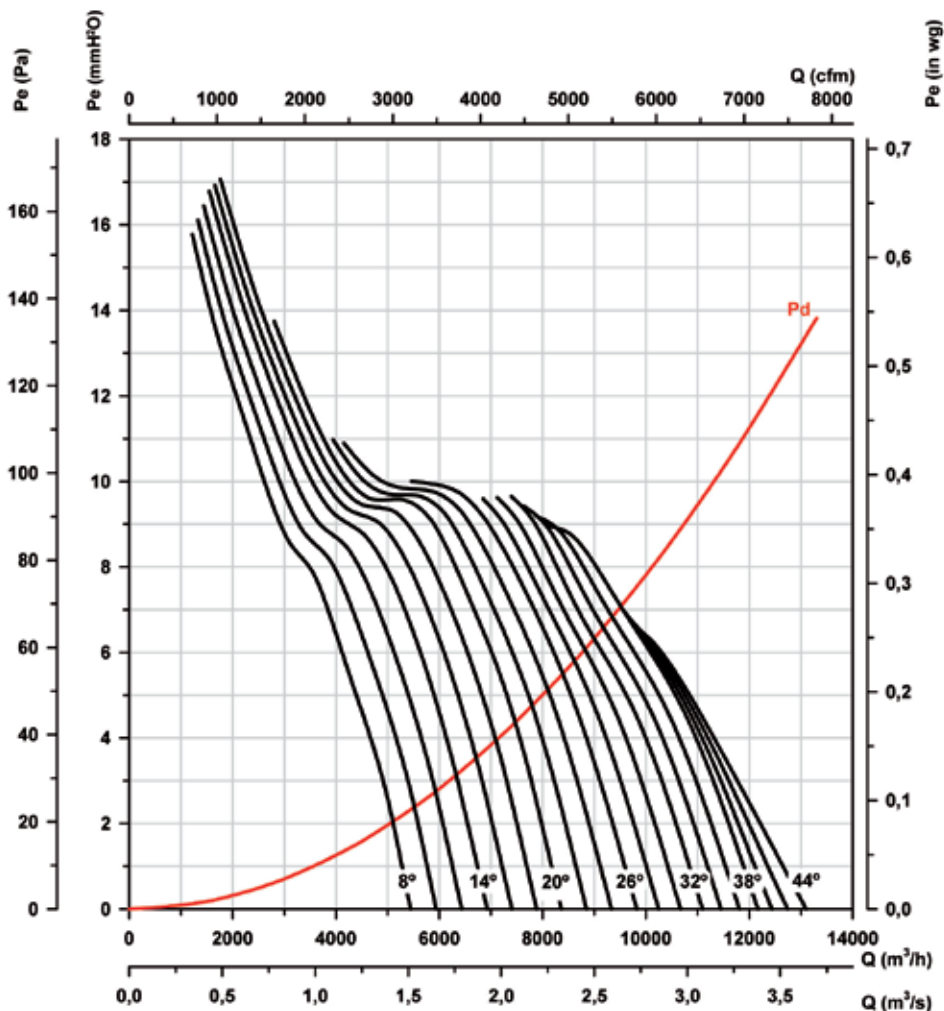

**Characteristic curves**

Q= Flow rate in m<sup>3</sup>/h, m<sup>3</sup>/s and cfm.

Pe= Static pressure in mm H<sub>2</sub>O, Pa and inwg.

**Rotor diameter (cm): 63**

**Number of poles: 2**

**Number of blades: 6**

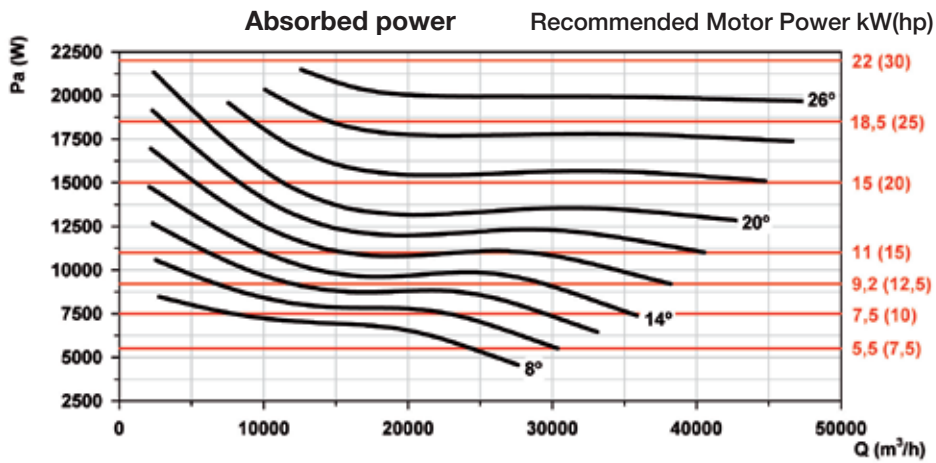
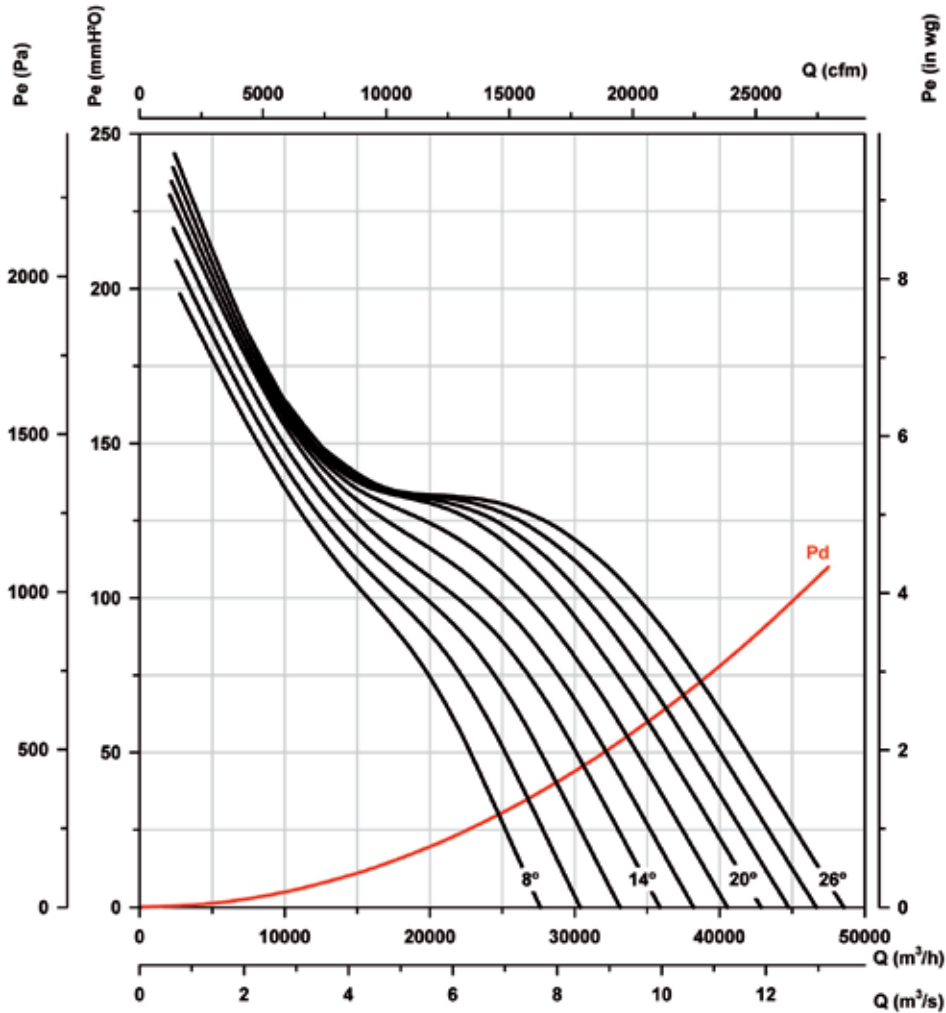

**Characteristic curves**

Q= Flow rate in m<sup>3</sup>/h, m<sup>3</sup>/s and cfm.

Pe= Static pressure in mm H<sub>2</sub>O, Pa and inwg.

**Rotor diameter (cm): 63**

**Number of poles: 4**

**Number of blades: 6**

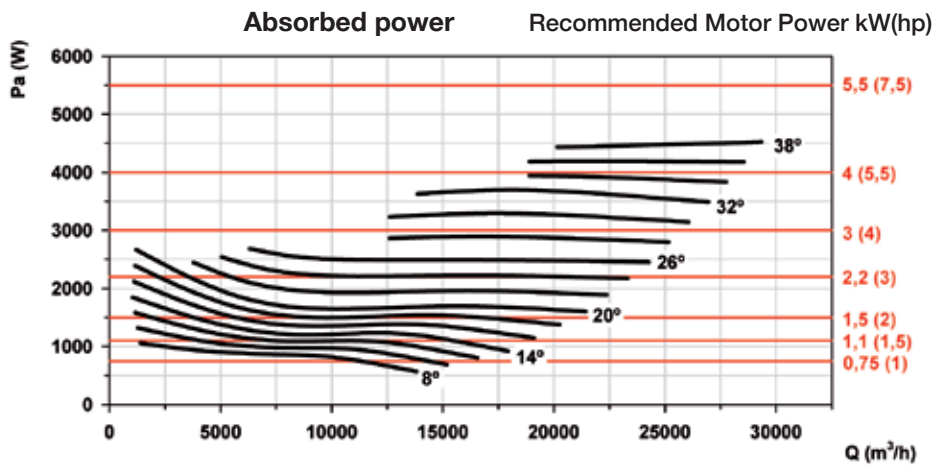
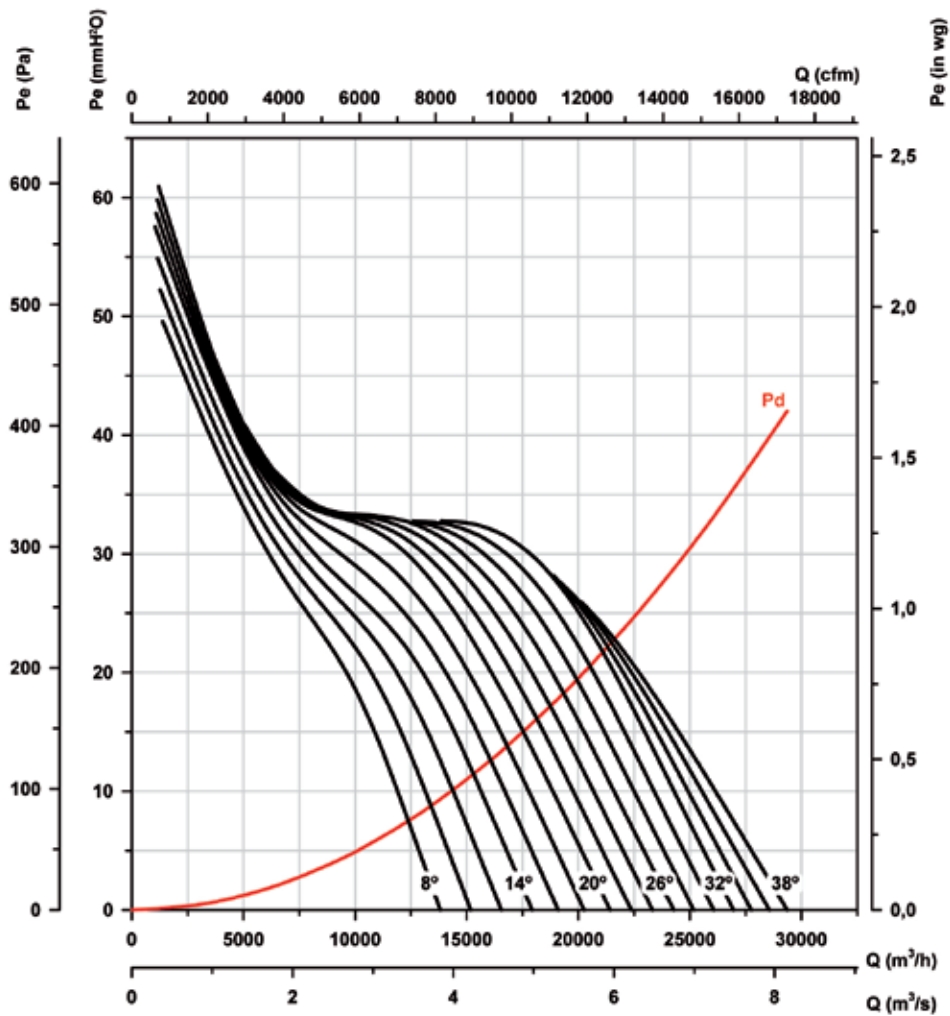

**Characteristic curves**

Q= Flow rate in m<sup>3</sup>/h, m<sup>3</sup>/s and cfm.

Pe= Static pressure in mm H<sub>2</sub>O, Pa and inwg.

**Rotor diameter (cm): 63**

**Number of poles: 6**

**Number of blades: 6**

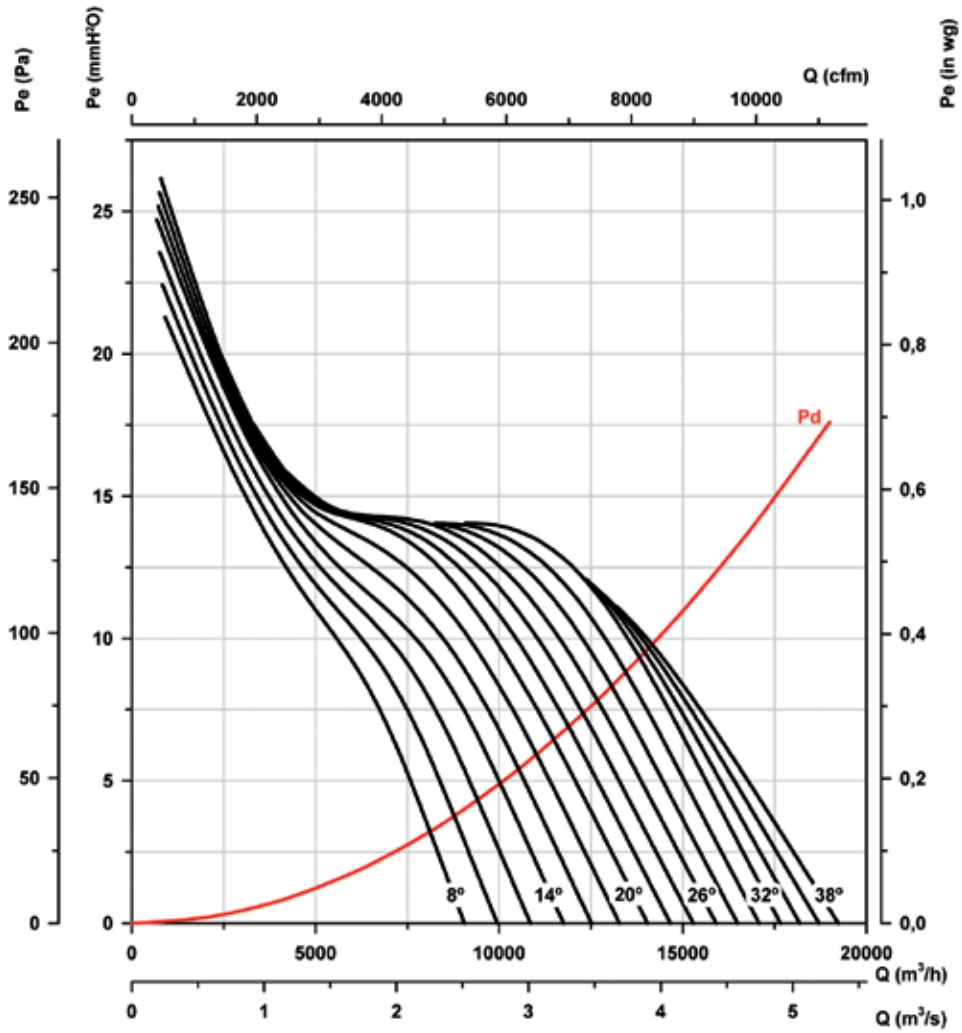

**Absorbed power**

**Recommended Motor Power kW(hp)**

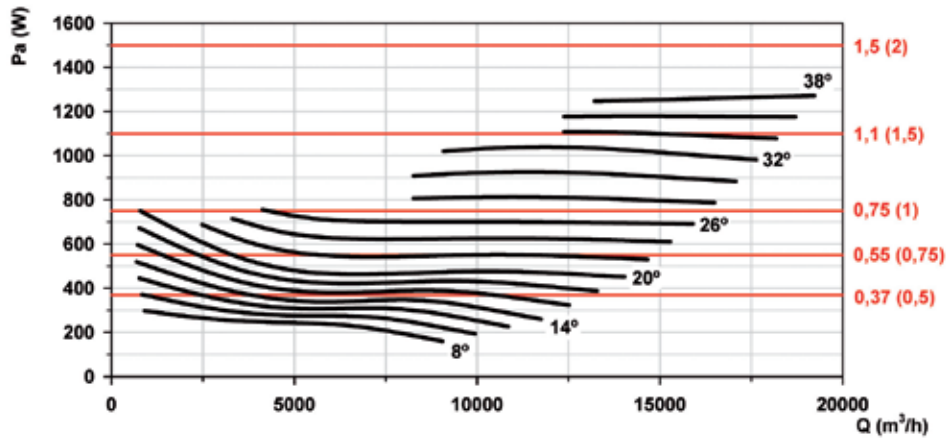

**Characteristic curves**

Q= Flow rate in m<sup>3</sup>/h, m<sup>3</sup>/s and cfm.

Pe= Static pressure in mm H<sub>2</sub>O, Pa and inwg.

**Rotor diameter (cm): 71**

**Number of poles: 4**

**Number of blades: 6**

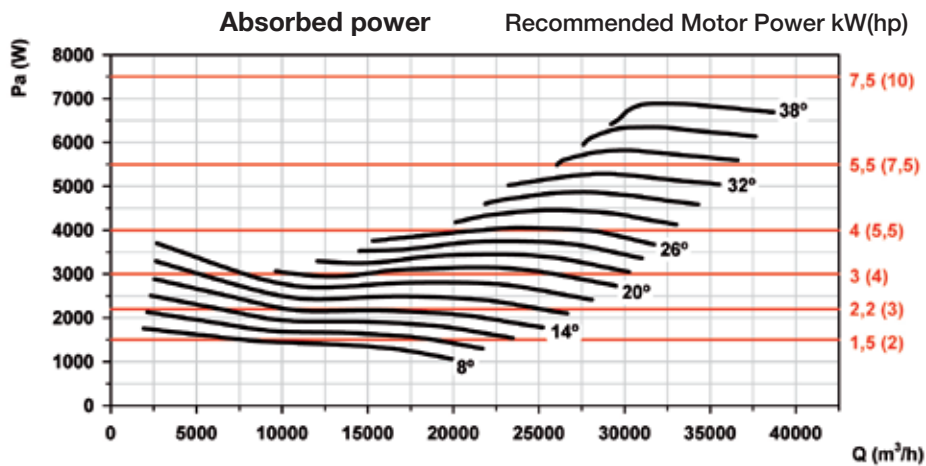
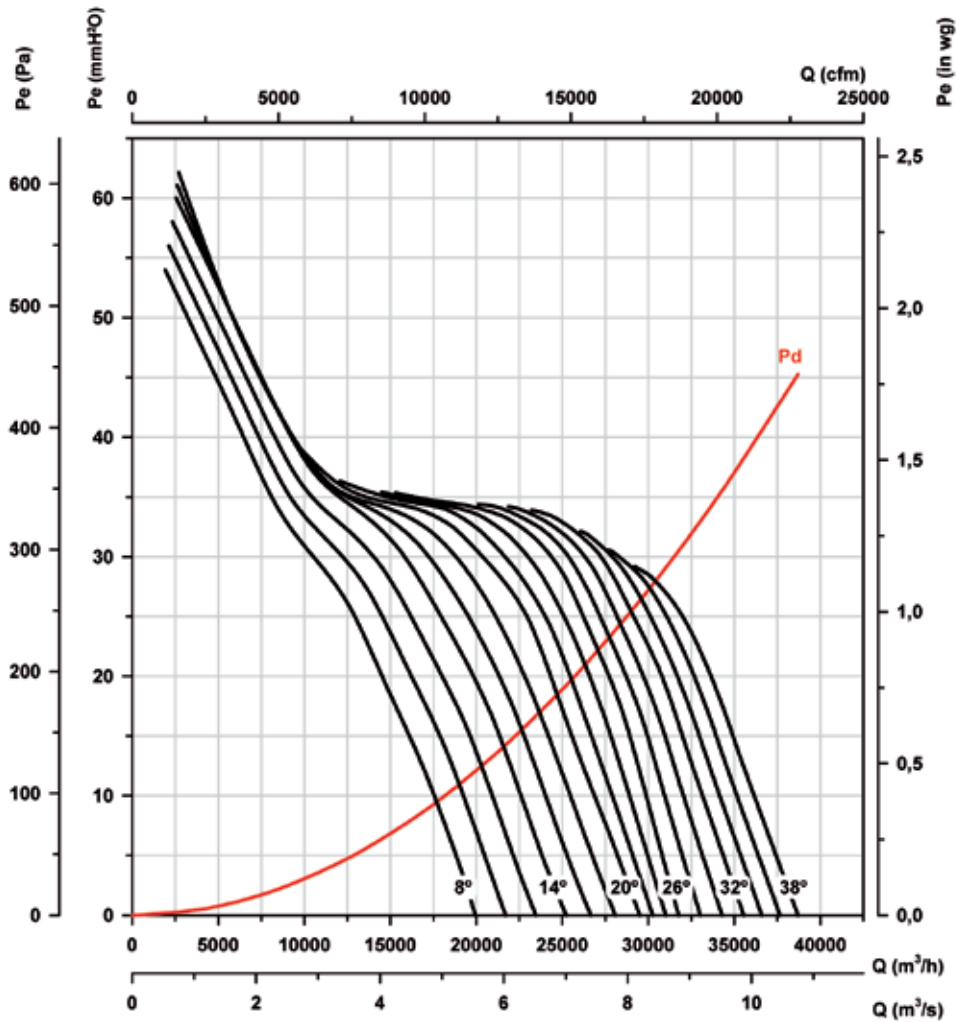



**Characteristic curves**

Q= Flow rate in m<sup>3</sup>/h, m<sup>3</sup>/s and cfm.

Pe= Static pressure in mm H<sub>2</sub>O, Pa and inwg.

**Rotor diameter (cm): 71**

**Number of poles: 6**

**Number of blades: 6**

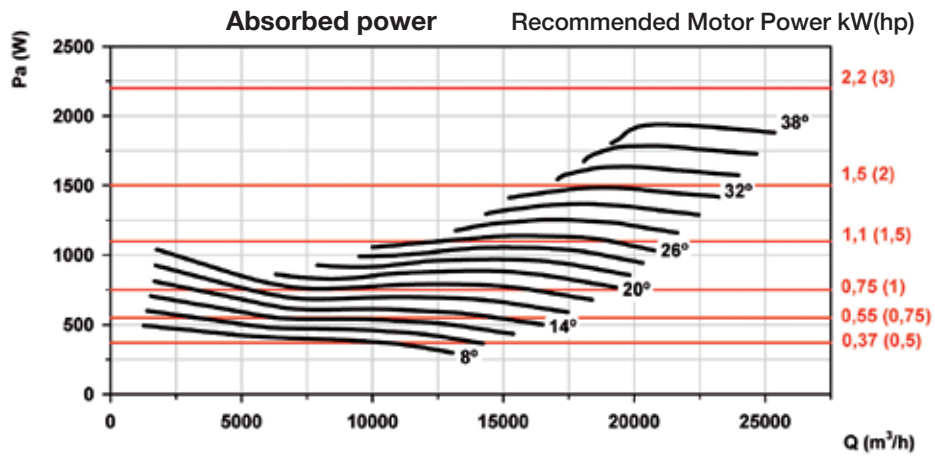
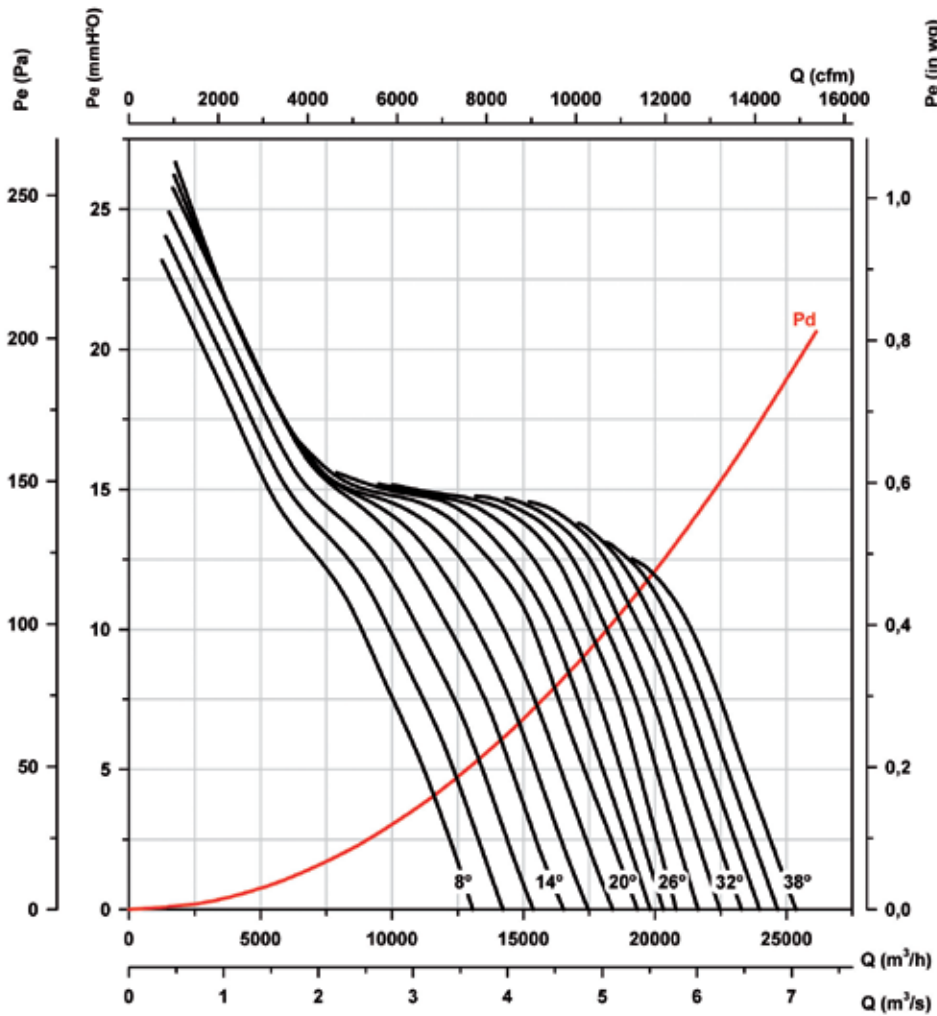

**Characteristic curves**

Q= Flow rate in m<sup>3</sup>/h, m<sup>3</sup>/s and cfm.

Pe= Static pressure in mm H<sub>2</sub>O, Pa and inwg.

**Rotor diameter (cm): 80**

**Number of poles: 4**

**Number of blades: 6**

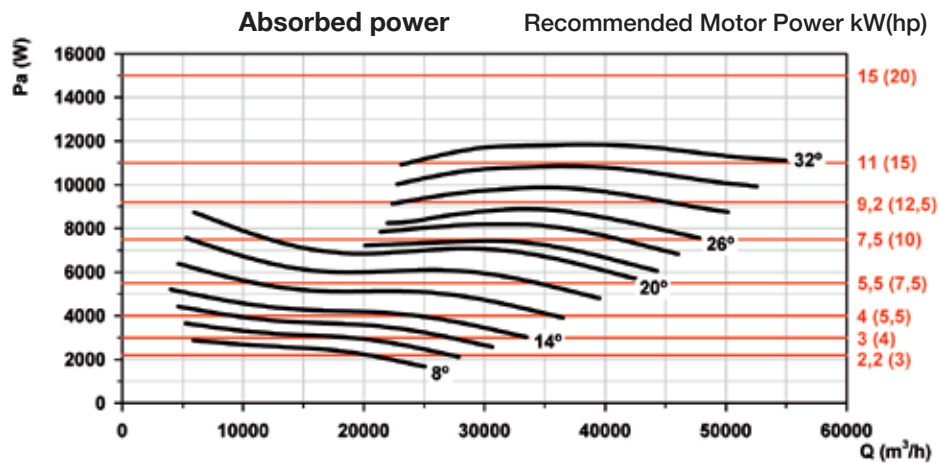
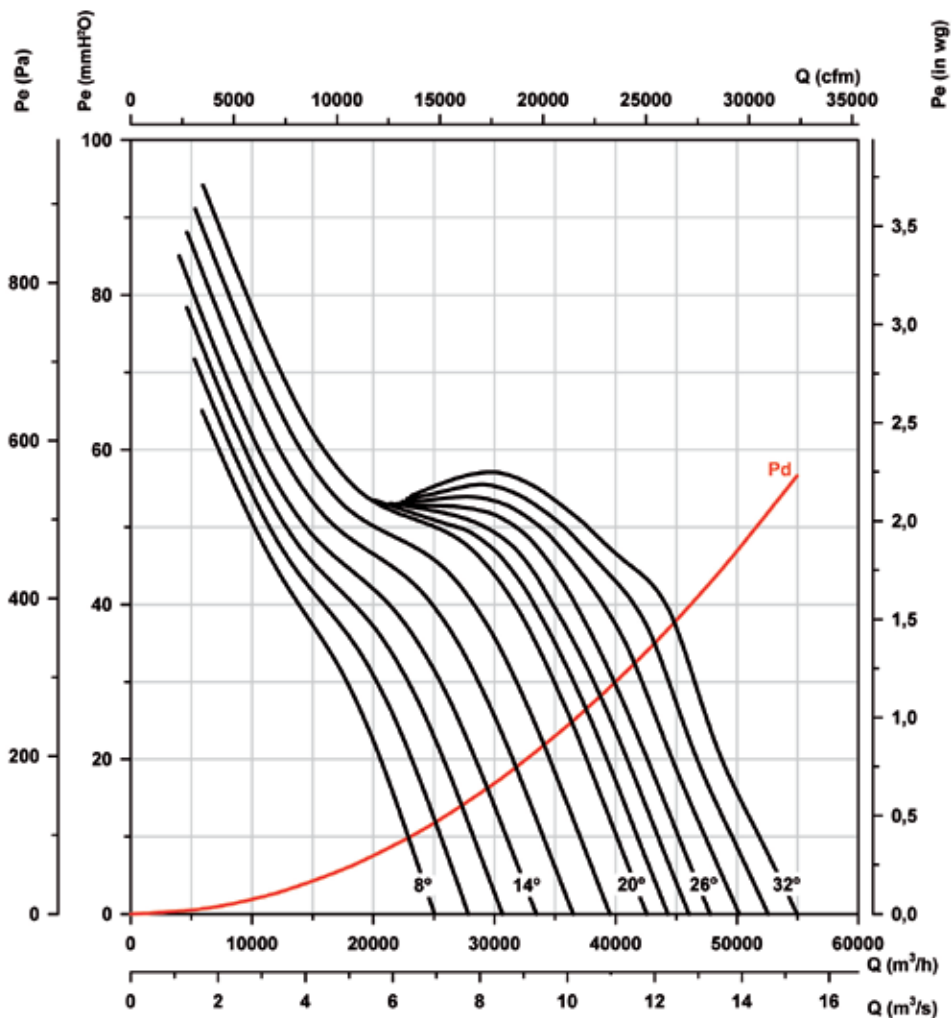

**Characteristic curves**

Q= Flow rate in m<sup>3</sup>/h, m<sup>3</sup>/s and cfm.

Pe= Static pressure in mm H<sub>2</sub>O, Pa and inwg.

**Rotor diameter (cm): 80**

**Number of poles: 6**

**Number of blades: 6**

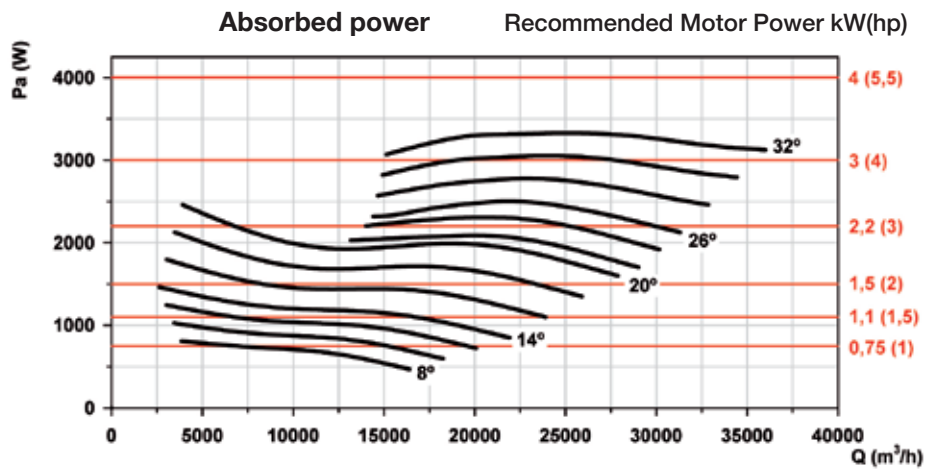
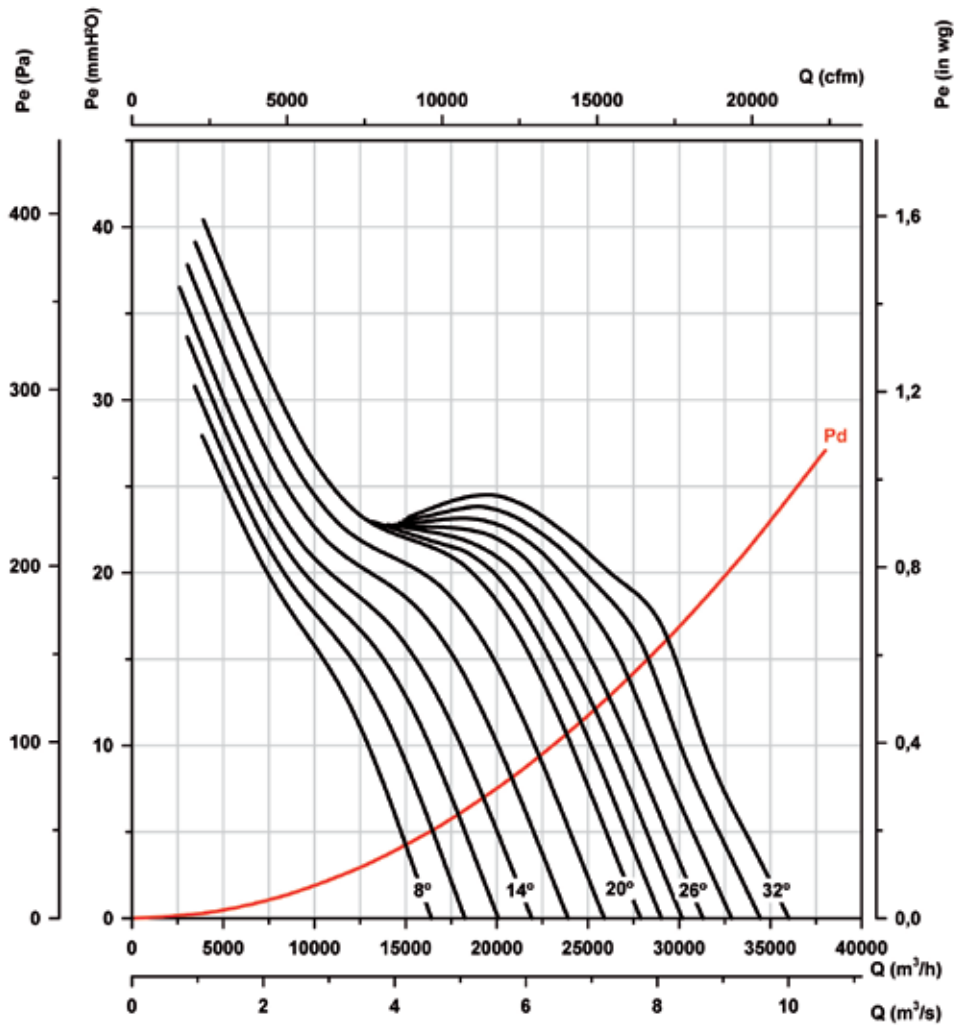

**Characteristic curves**

Q= Flow rate in m<sup>3</sup>/h, m<sup>3</sup>/s and cfm.

Pe= Static pressure in mm H<sub>2</sub>O, Pa and inwg.

**Rotor diameter (cm): 80**

**Number of poles: 8**

**Number of blades: 6**

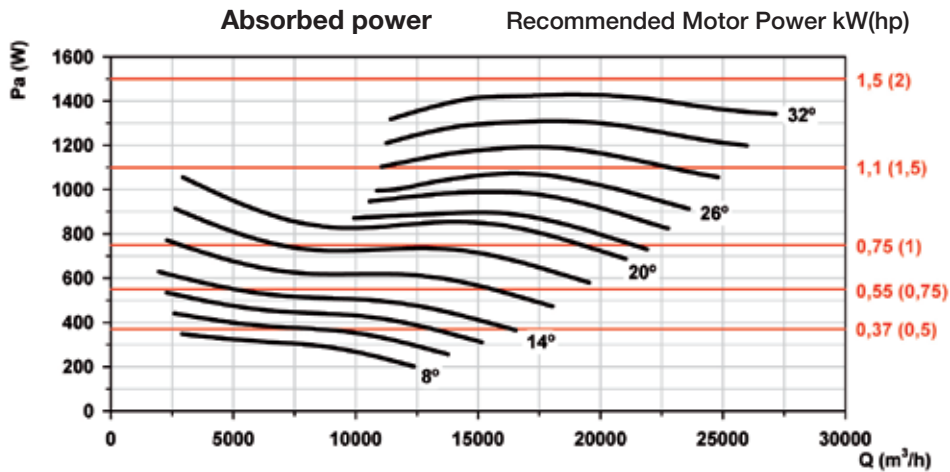
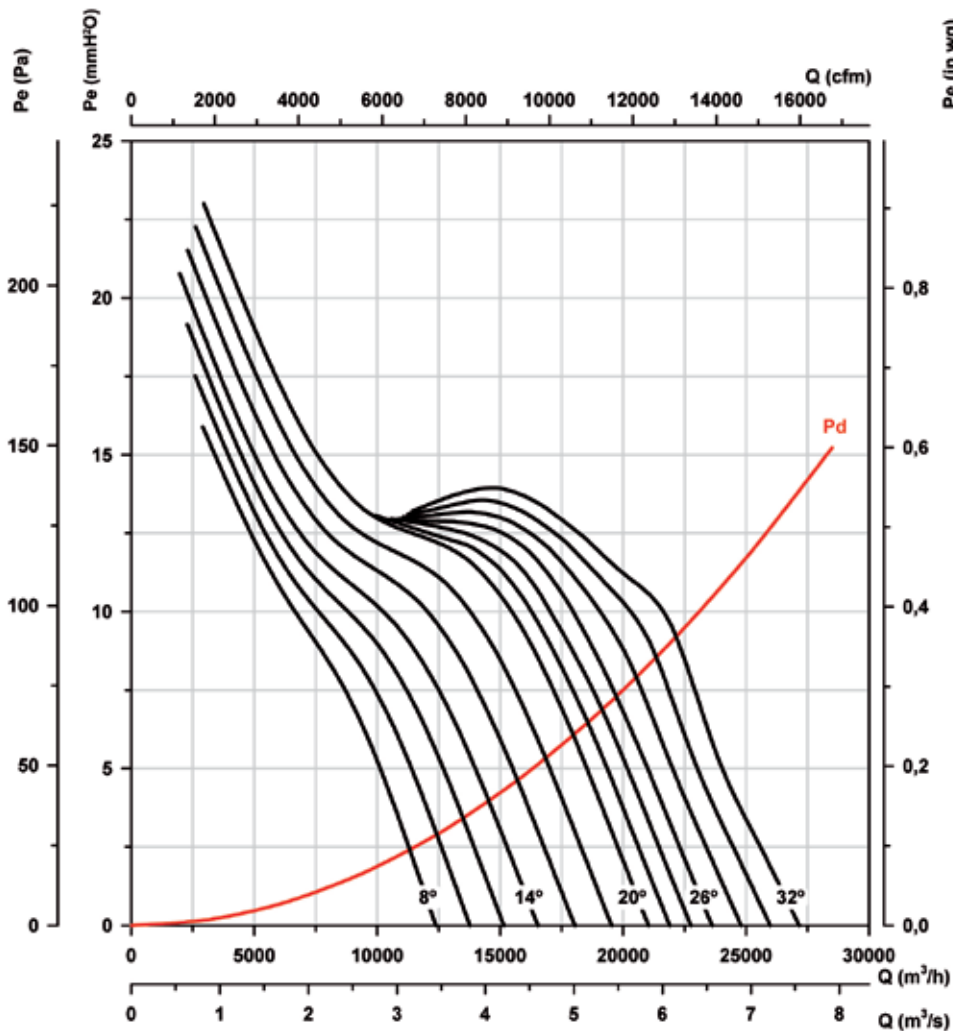

**Characteristic curves**

Q= Flow rate in m<sup>3</sup>/h, m<sup>3</sup>/s and cfm.

Pe= Static pressure in mm H<sub>2</sub>O, Pa and inwg.

**Rotor diameter (cm): 90**

**Number of poles: 4**

**Number of blades: 6**

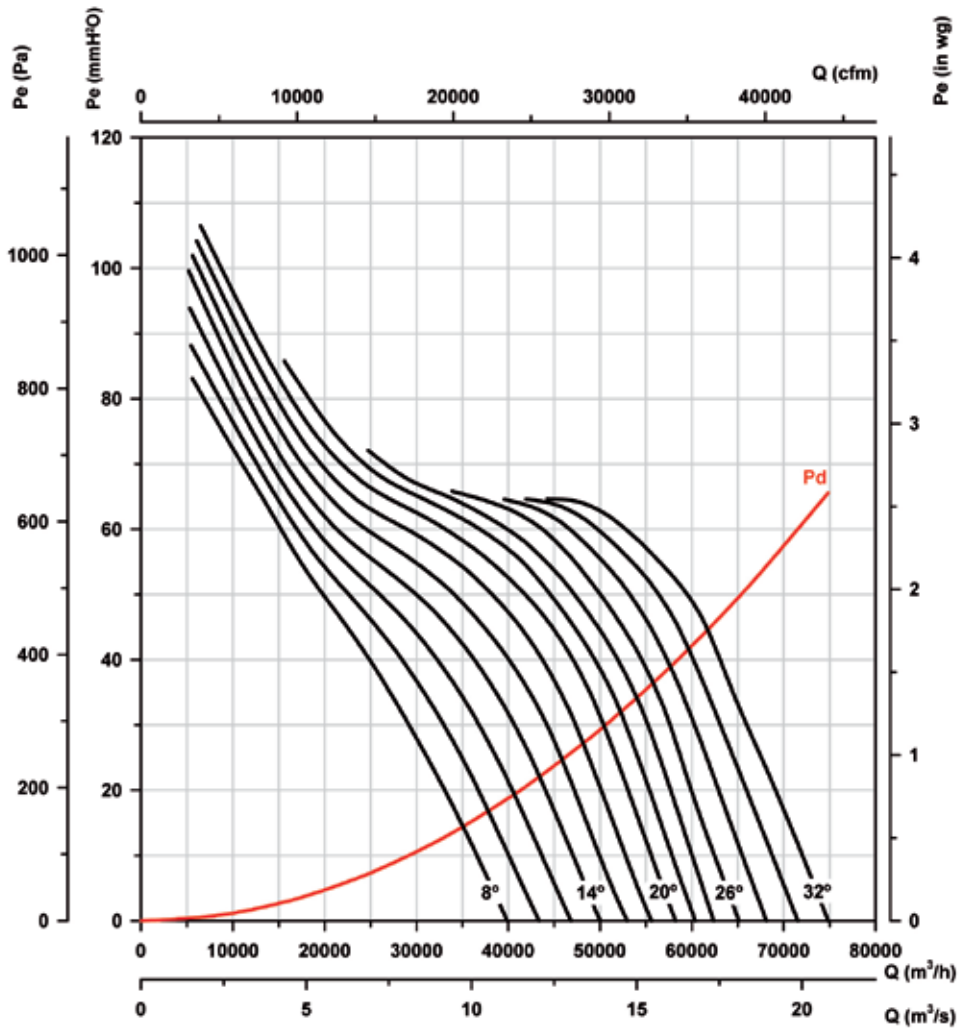

**Absorbed power**

**Recommended Motor Power kW(hp)**

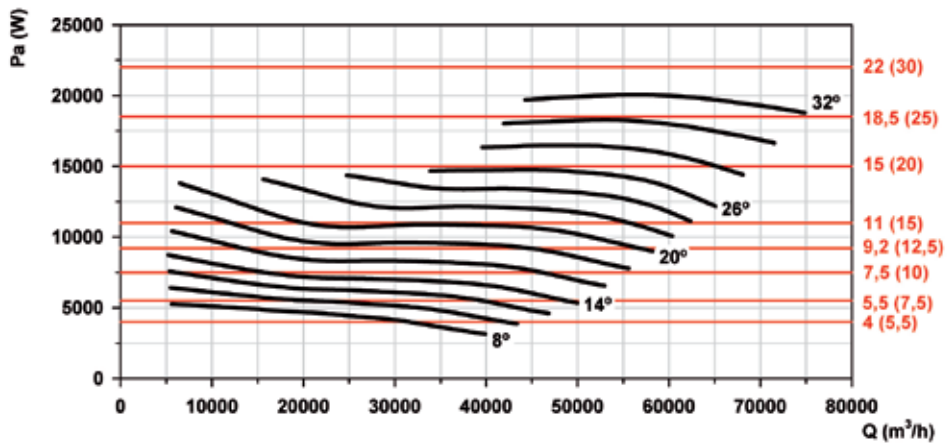

**Characteristic curves**

Q= Flow rate in m<sup>3</sup>/h, m<sup>3</sup>/s and cfm.

Pe= Static pressure in mm H<sub>2</sub>O, Pa and inwg.

**Rotor diameter (cm): 90**

**Number of poles: 6**

**Number of blades: 6**

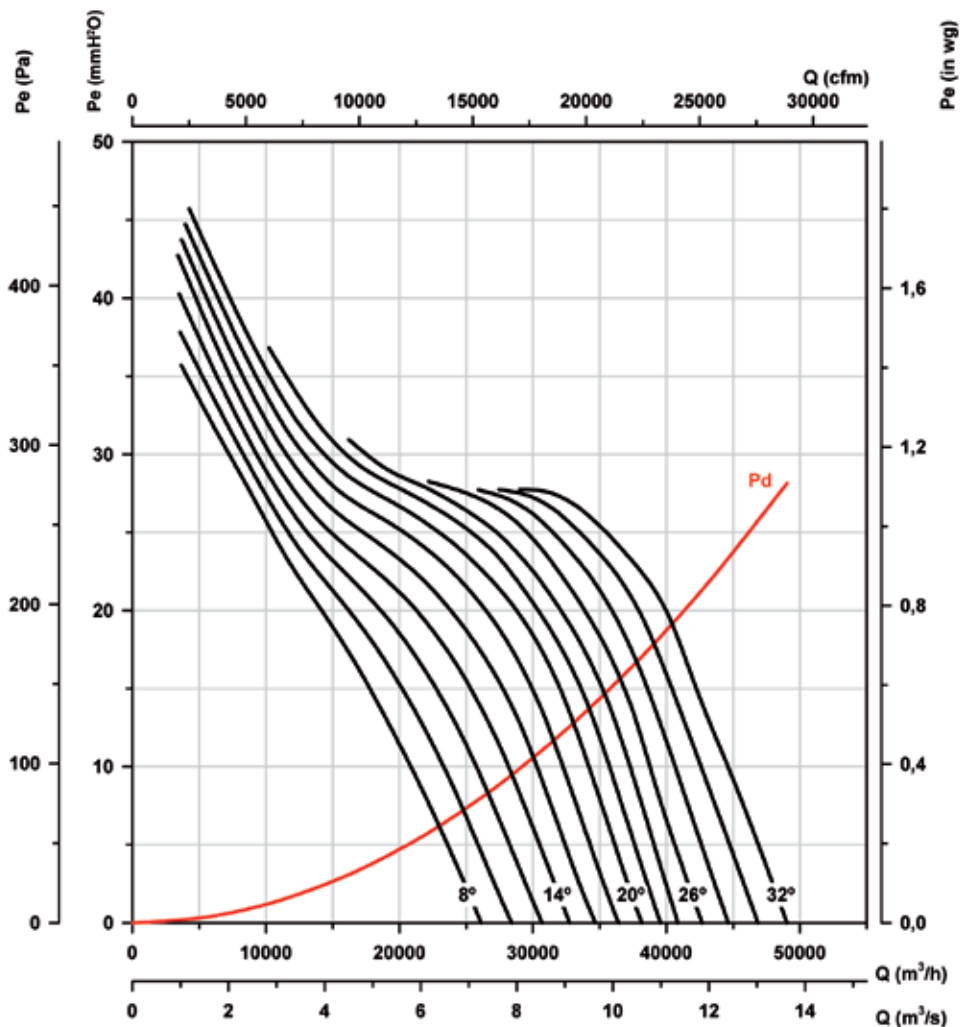

**Absorbed power**

**Recommended Motor Power kW(hp)**

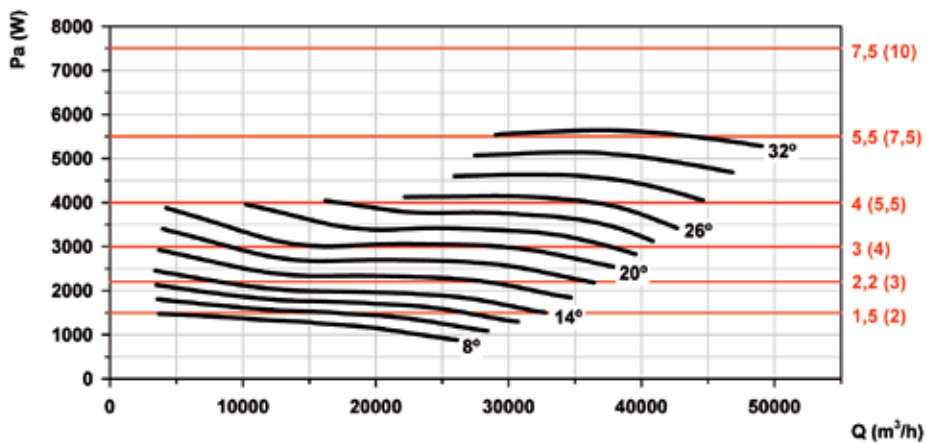

**Characteristic curves**

Q= Flow rate in m<sup>3</sup>/h, m<sup>3</sup>/s and cfm.

Pe= Static pressure in mm H<sub>2</sub>O, Pa and inwg.

**Rotor diameter (cm): 90**

**Number of poles: 8**

**Number of blades: 6**

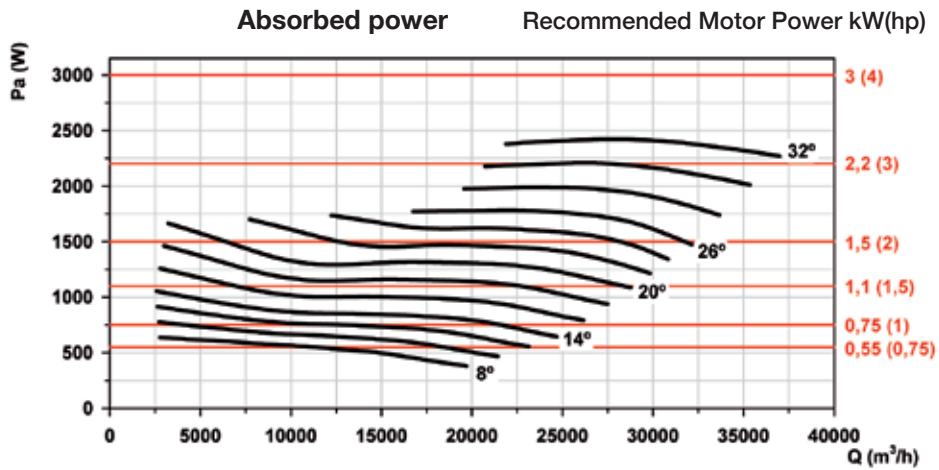
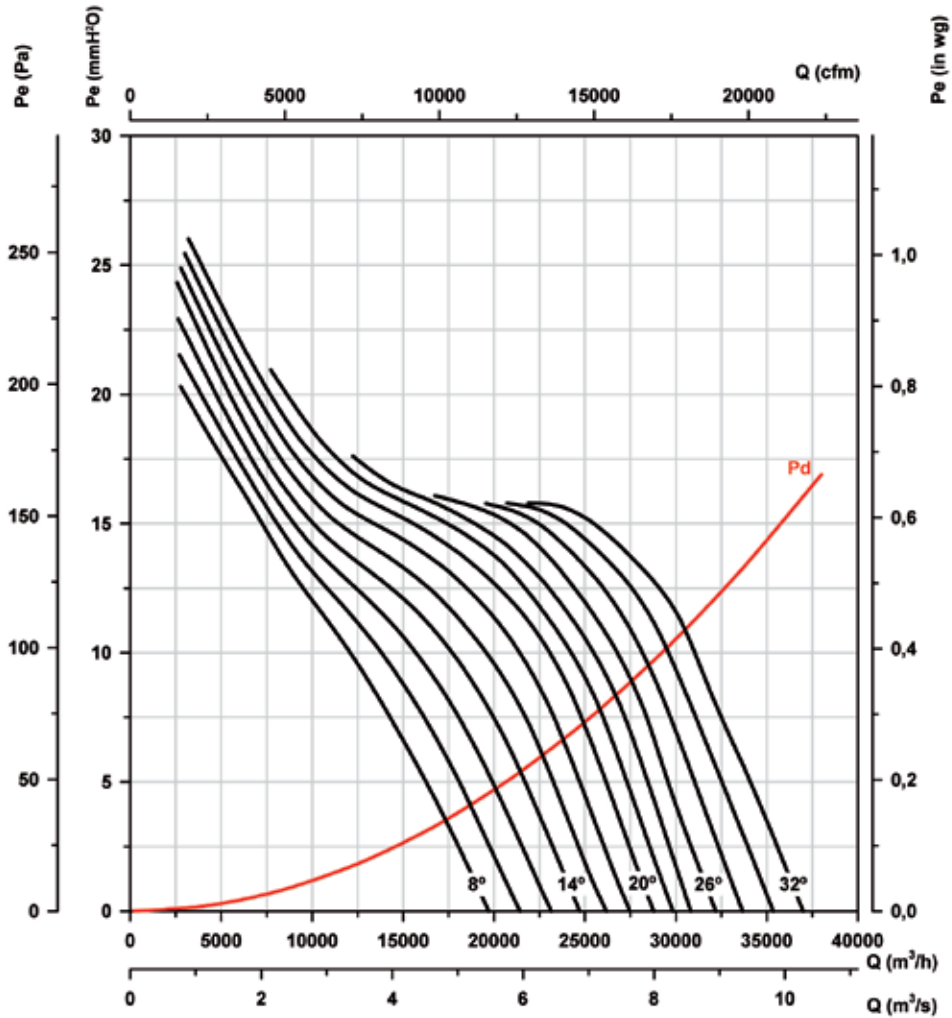

**Characteristic curves**

Q= Flow rate in m<sup>3</sup>/h, m<sup>3</sup>/s and cfm.

Pe= Static pressure in mm H<sub>2</sub>O, Pa and inwg.

**Rotor diameter (cm): 100**

**Number of poles: 4**

**Number of blades: 6**

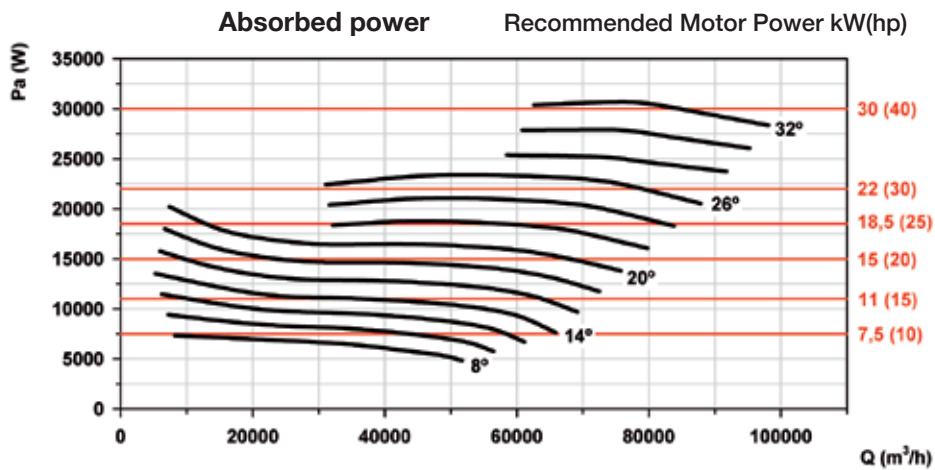
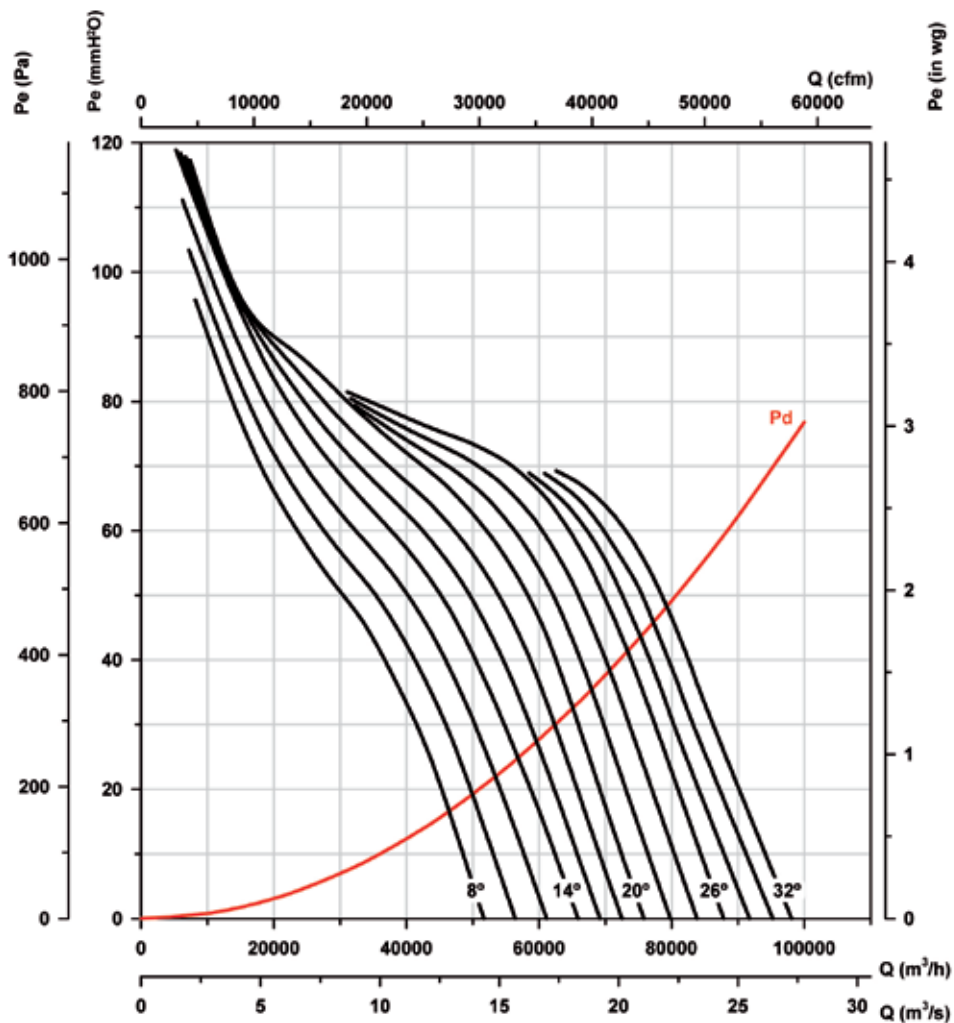



**Characteristic curves**

Q= Flow rate in m<sup>3</sup>/h, m<sup>3</sup>/s and cfm.

Pe= Static pressure in mm H<sub>2</sub>O, Pa and inwg.

**Rotor diameter (cm): 100**

**Number of poles: 6**

**Number of blades: 6**

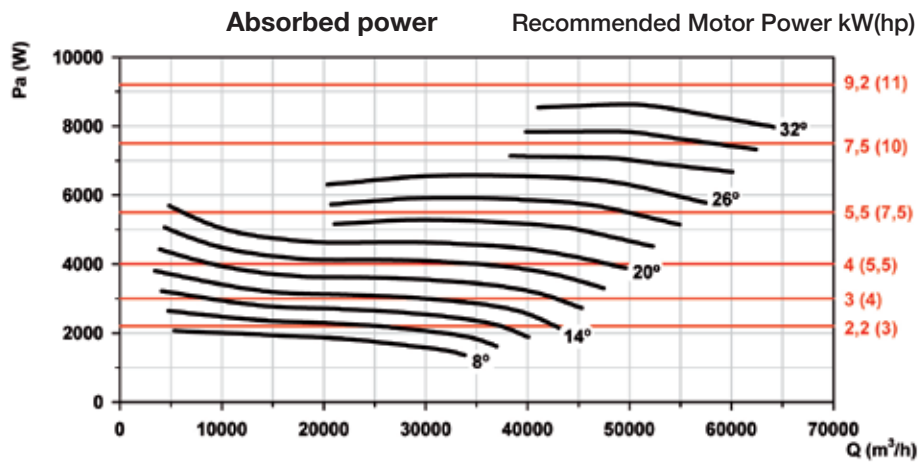
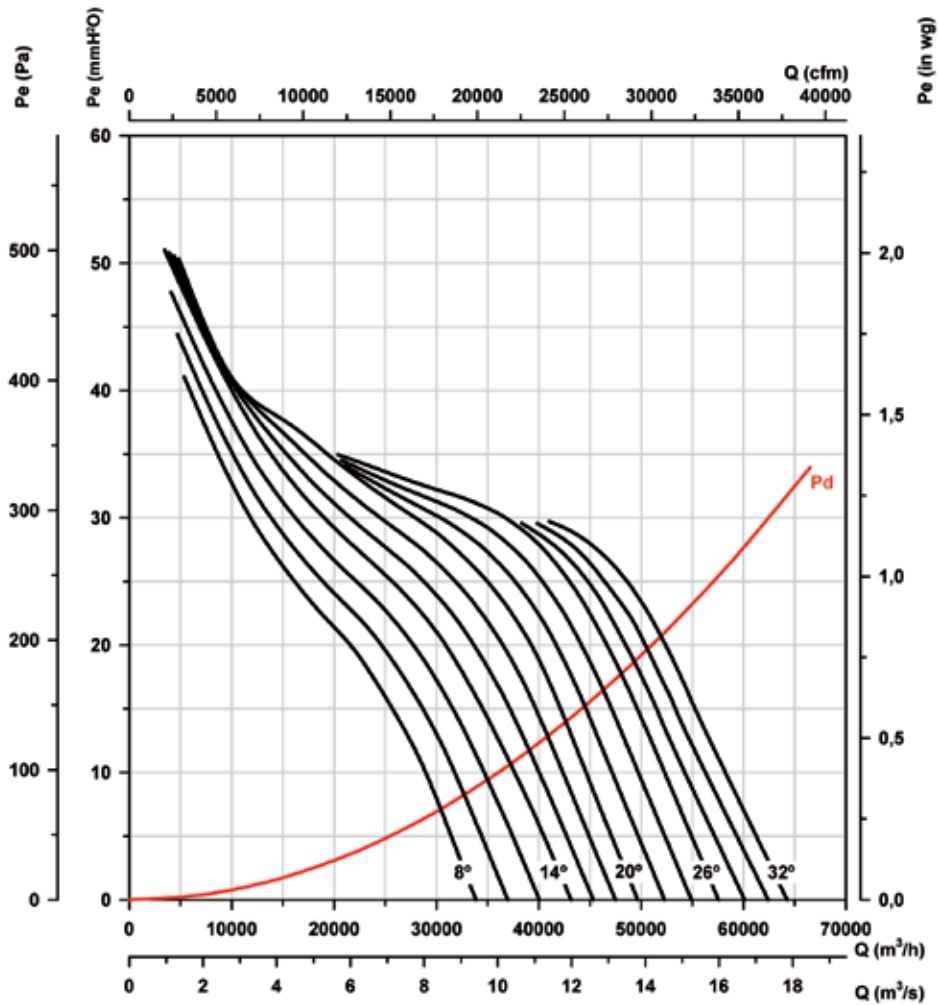

**Characteristic curves**

Q= Flow rate in m<sup>3</sup>/h, m<sup>3</sup>/s and cfm.

Pe= Static pressure in mm H<sub>2</sub>O, Pa and inwg.

**Rotor diameter (cm): 100**

**Number of poles: 8**

**Number of blades: 6**

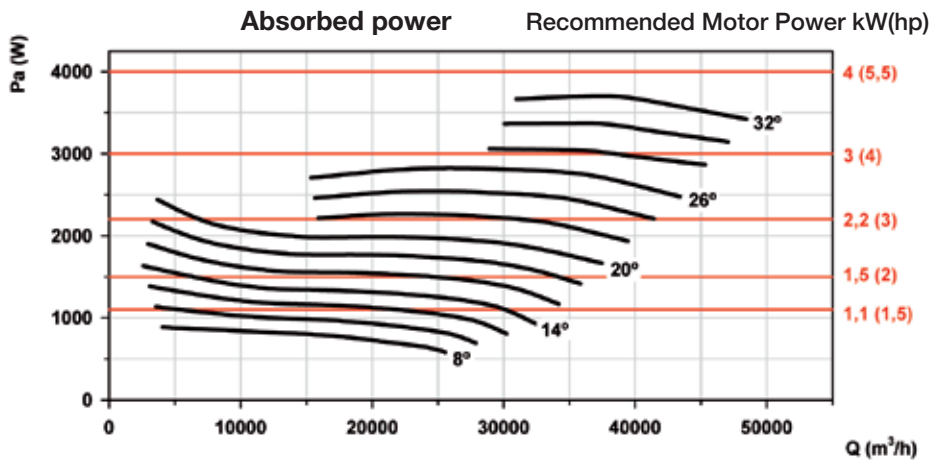
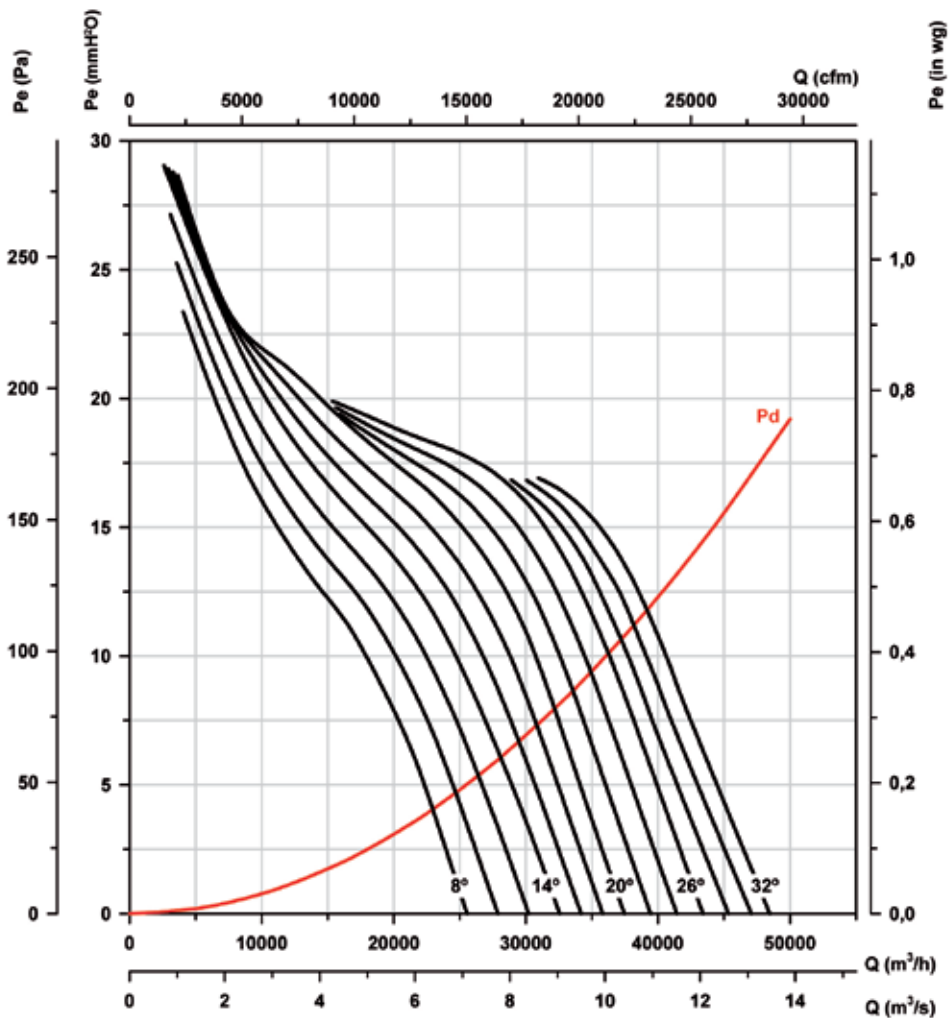

**Characteristic curves**

Q= Flow rate in m<sup>3</sup>/h, m<sup>3</sup>/s and cfm.

Pe= Static pressure in mm H<sub>2</sub>O, Pa and inwg.

**Rotor diameter (cm): 125**

**Number of poles: 4**

**Number of blades: 3**

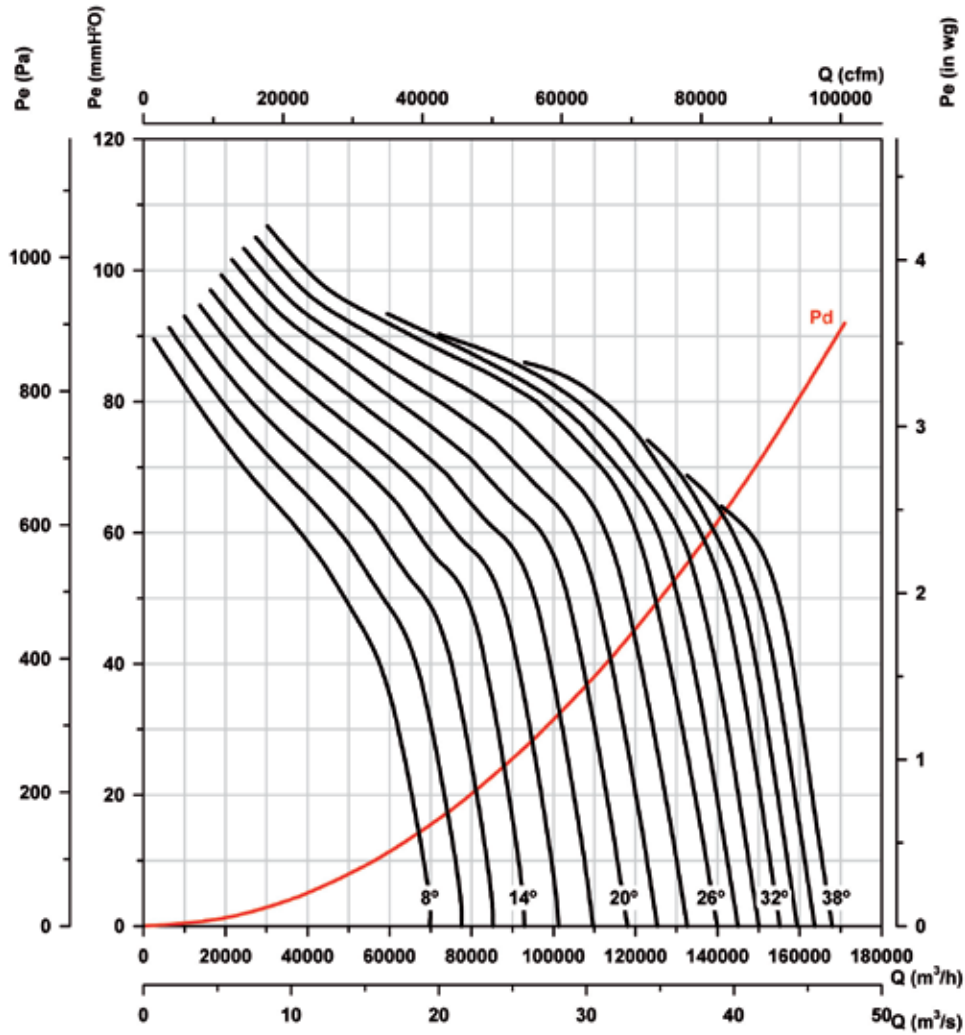

**Absorbed power**

**Recommended Motor Power kW(hp)**

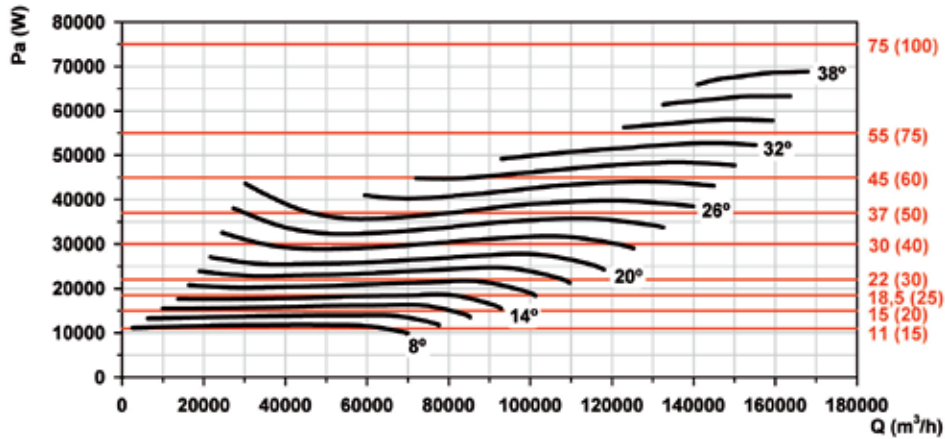

**Characteristic curves**

Q= Flow rate in m<sup>3</sup>/h, m<sup>3</sup>/s and cfm.

Pe= Static pressure in mm H<sub>2</sub>O, Pa and inwg.

**Rotor diameter (cm): 125**

**Number of poles: 4**

**Number of blades: 6**

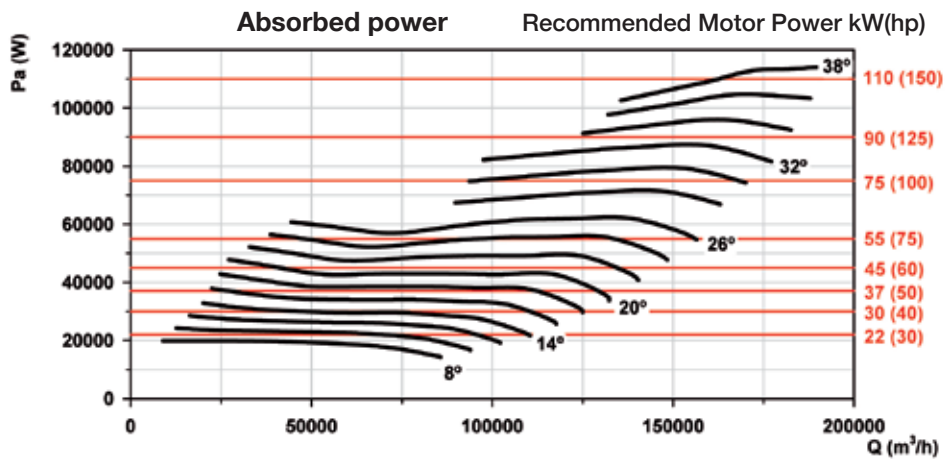
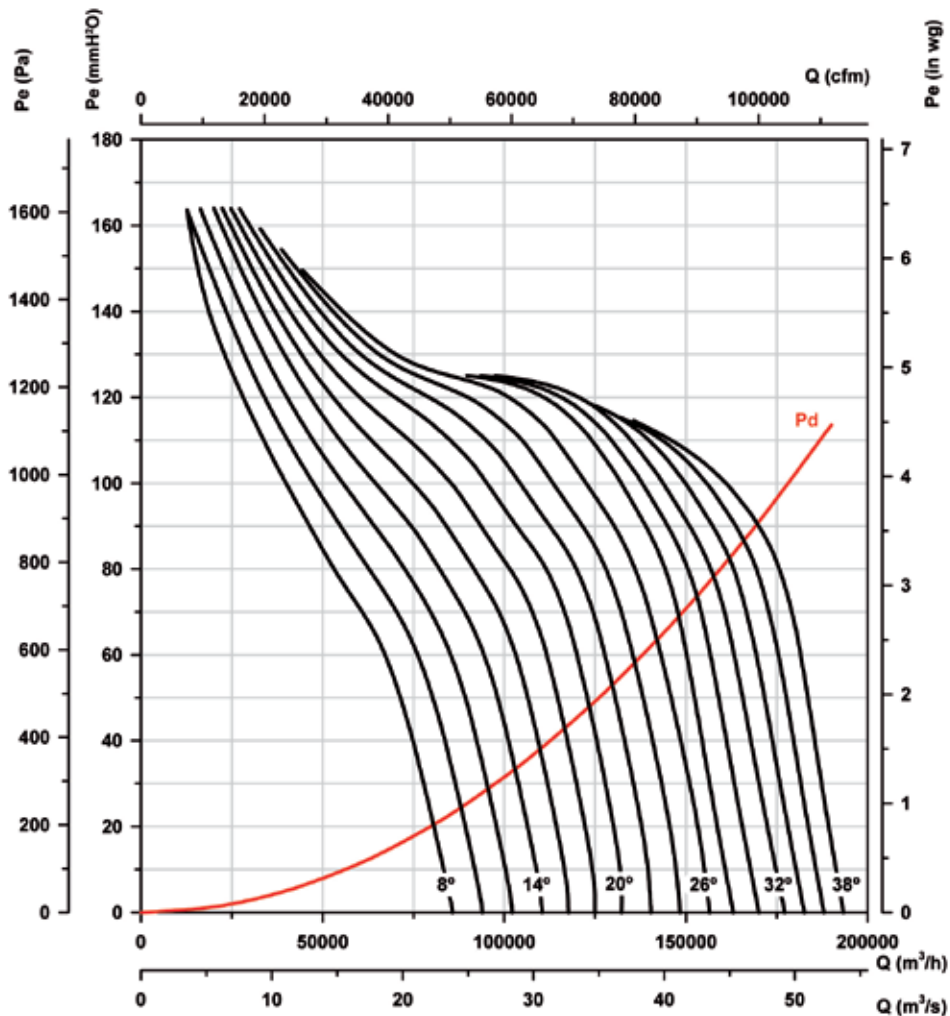

**Characteristic curves**

Q= Flow rate in m<sup>3</sup>/h, m<sup>3</sup>/s and cfm.

Pe= Static pressure in mm H<sub>2</sub>O, Pa and inwg.

**Rotor diameter (cm): 125**

**Number of poles: 4**

**Number of blades: 9**

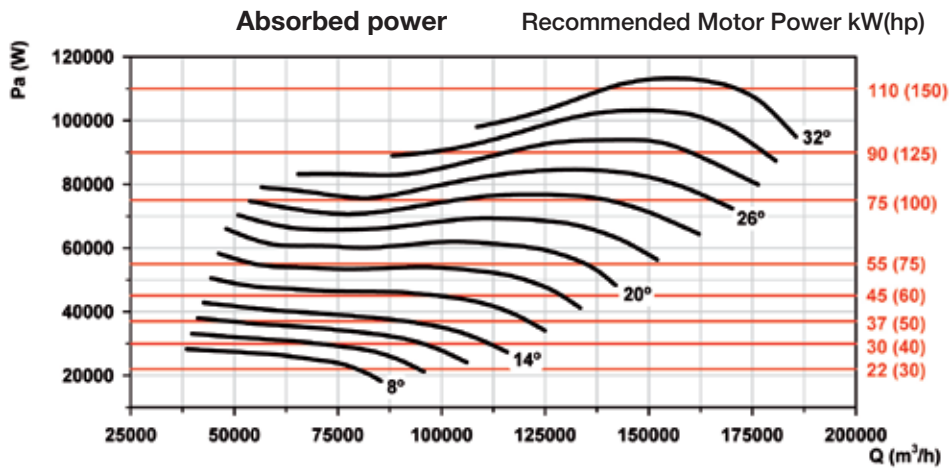
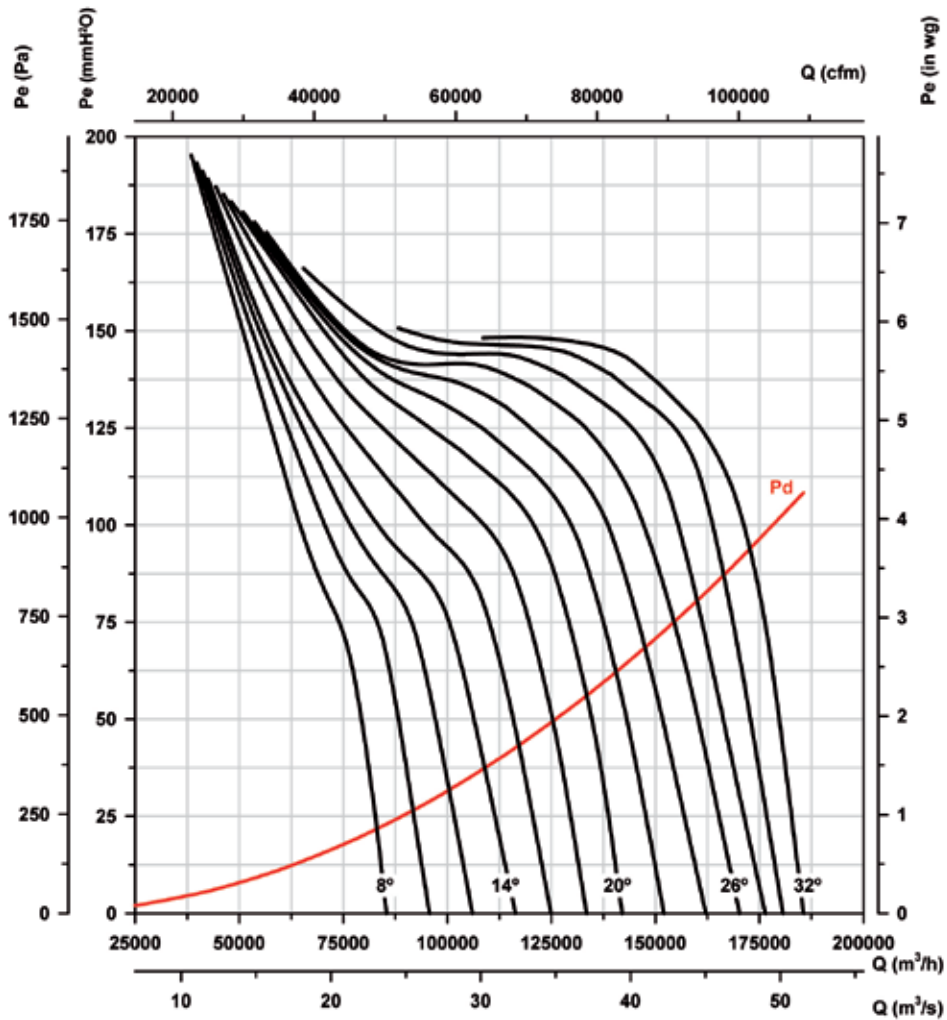

**Characteristic curves**

Q= Flow rate in m<sup>3</sup>/h, m<sup>3</sup>/s and cfm.

Pe= Static pressure in mm H<sub>2</sub>O, Pa and inwg.

**Rotor diameter (cm): 125**

**Number of poles: 6**

**Number of blades: 3**

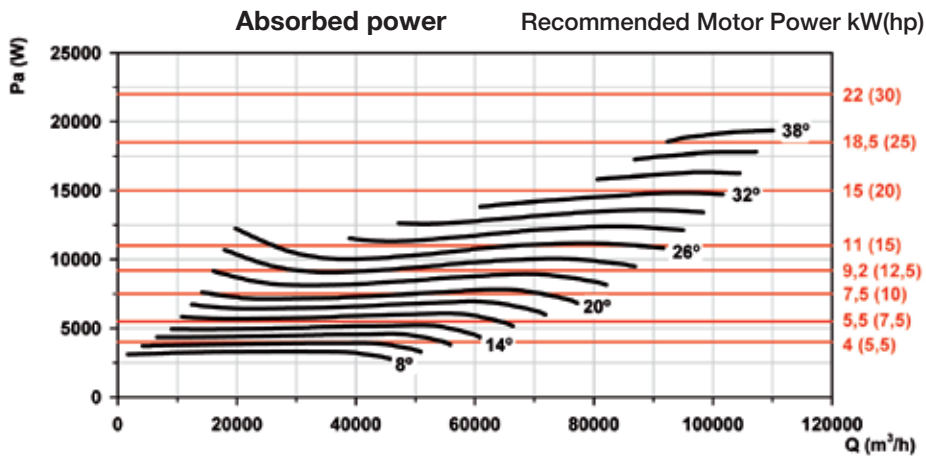
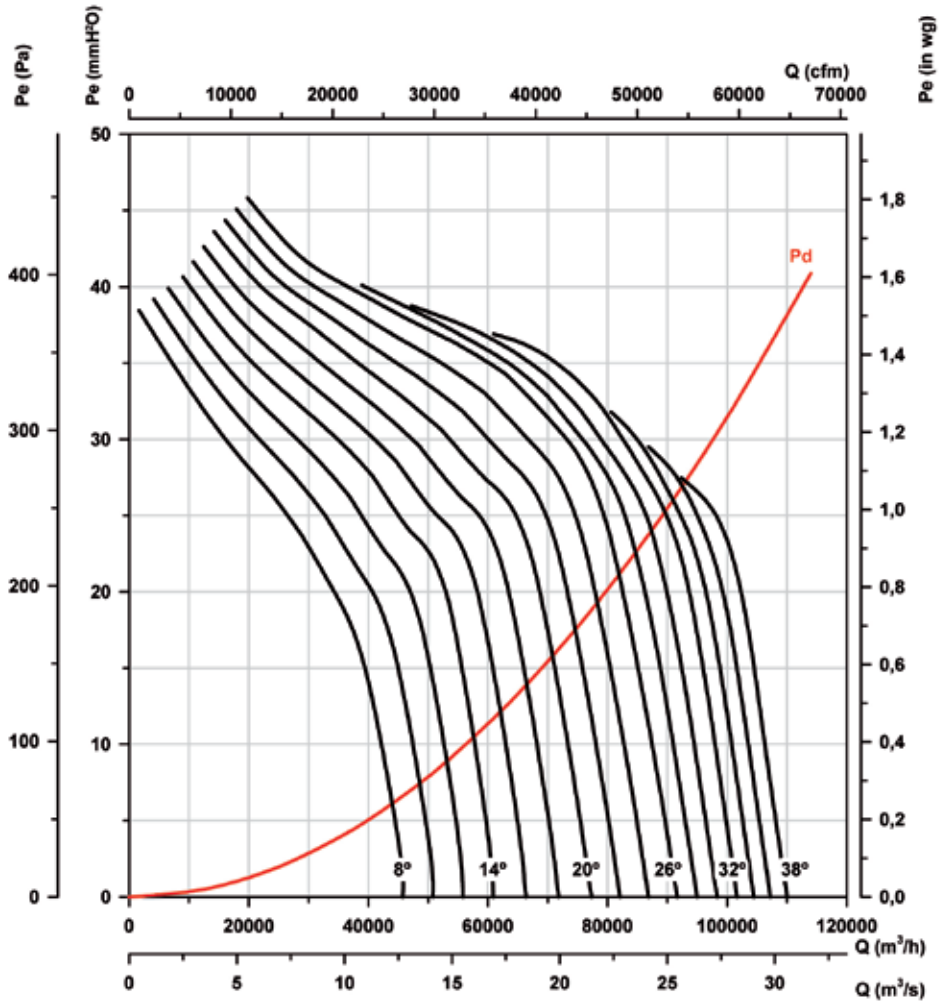

**Characteristic curves**

Q= Flow rate in m<sup>3</sup>/h, m<sup>3</sup>/s and cfm.

Pe= Static pressure in mmH<sub>2</sub>O, Pa and inwg.

**Rotor diameter (cm): 125**

**Number of poles: 6**

**Number of blades: 6**

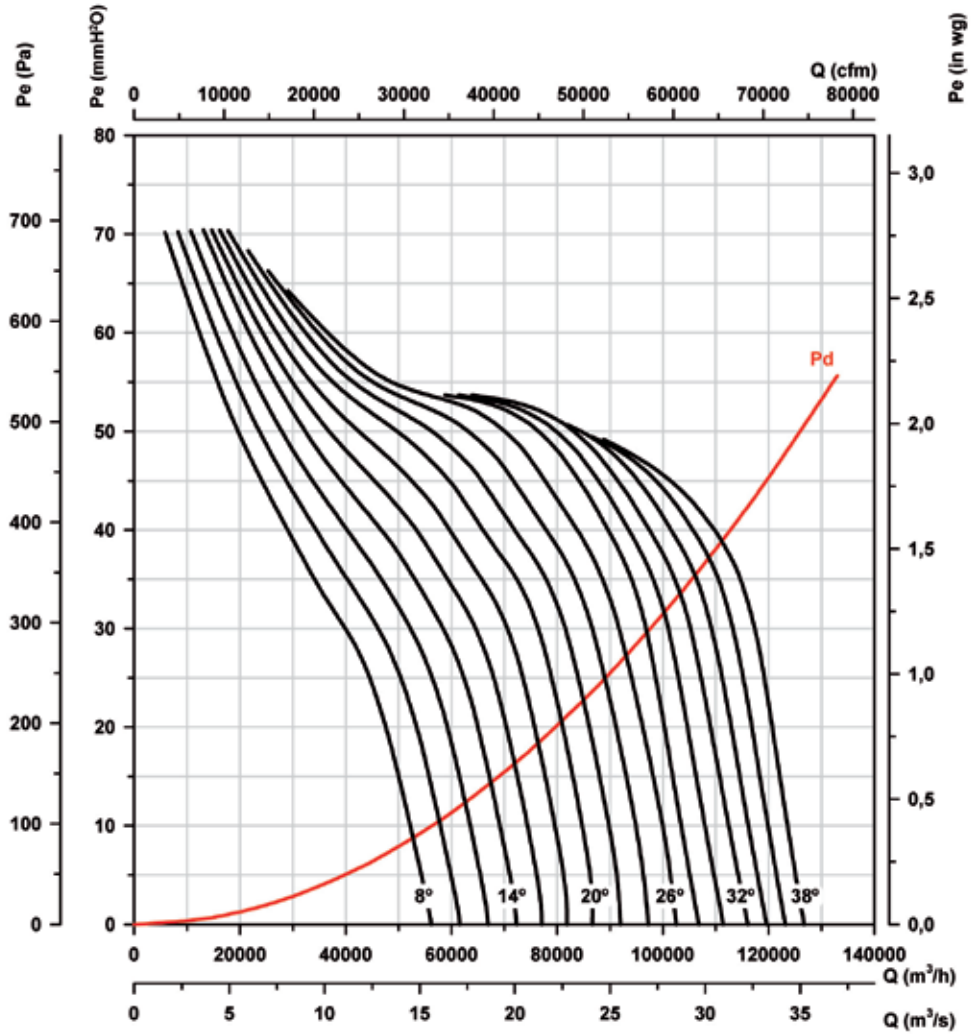

**Absorbed power**

**Recommended Motor Power kW(hp)**

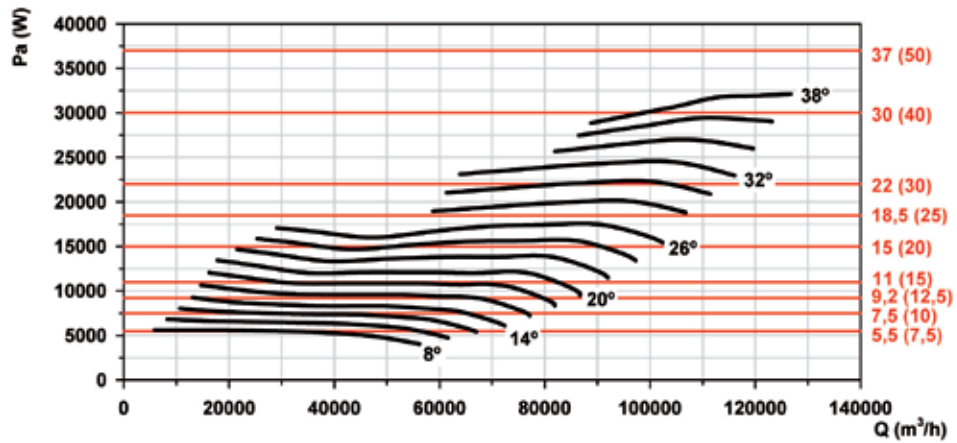

**Characteristic curves**

Q= Flow rate in m<sup>3</sup>/h, m<sup>3</sup>/s and cfm.

Pe= Static pressure in mmH<sub>2</sub>O, Pa and inwg.

**Rotor diameter (cm): 125**

**Number of poles: 6**

**Number of blades: 9**

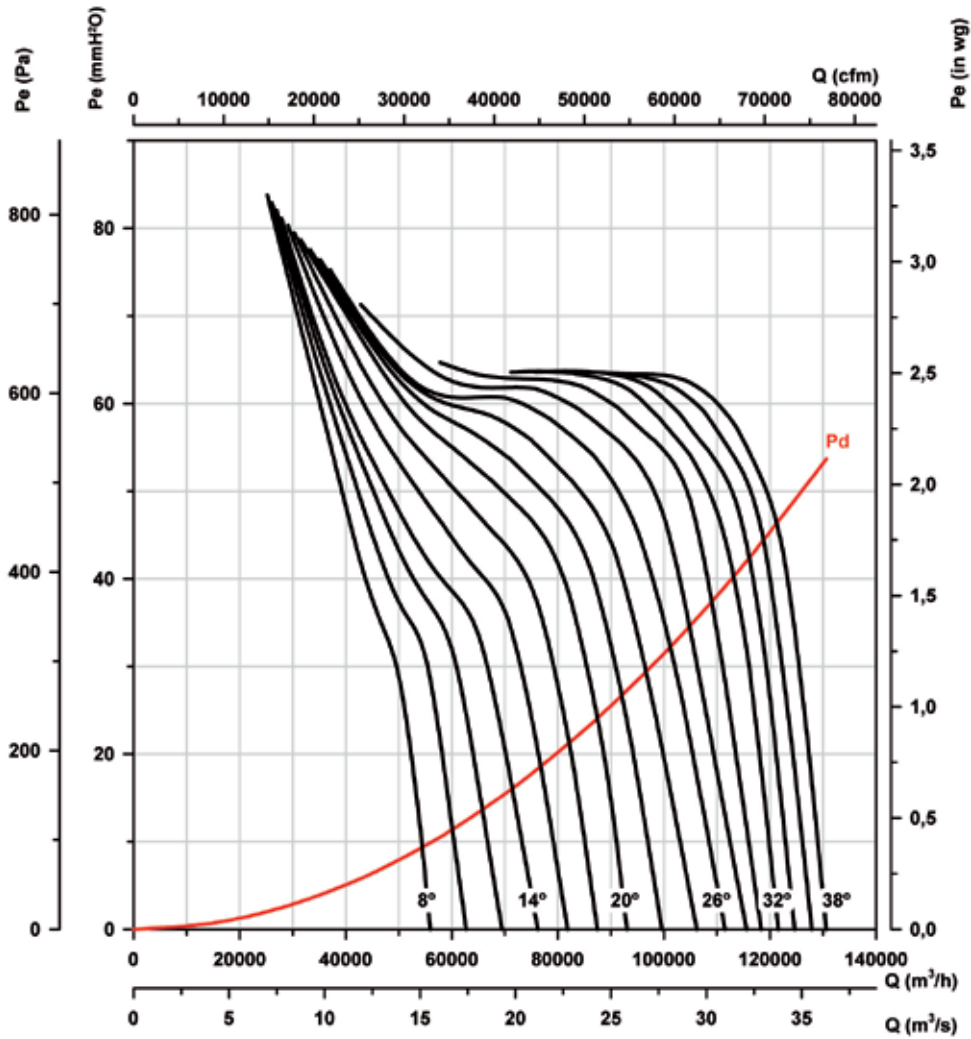

Absorbed power

Recommended Motor Power kW(hp)

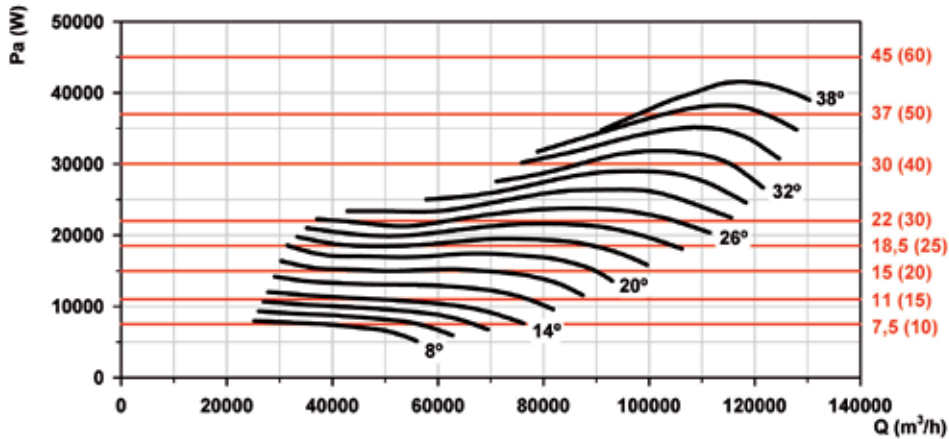



**Characteristic curves**

Q= Flow rate in m<sup>3</sup>/h, m<sup>3</sup>/s and cfm.

Pe= Static pressure in mmH<sub>2</sub>O, Pa and inwg.

**Rotor diameter (cm): 140**

**Number of poles: 6**

**Number of blades: 3**

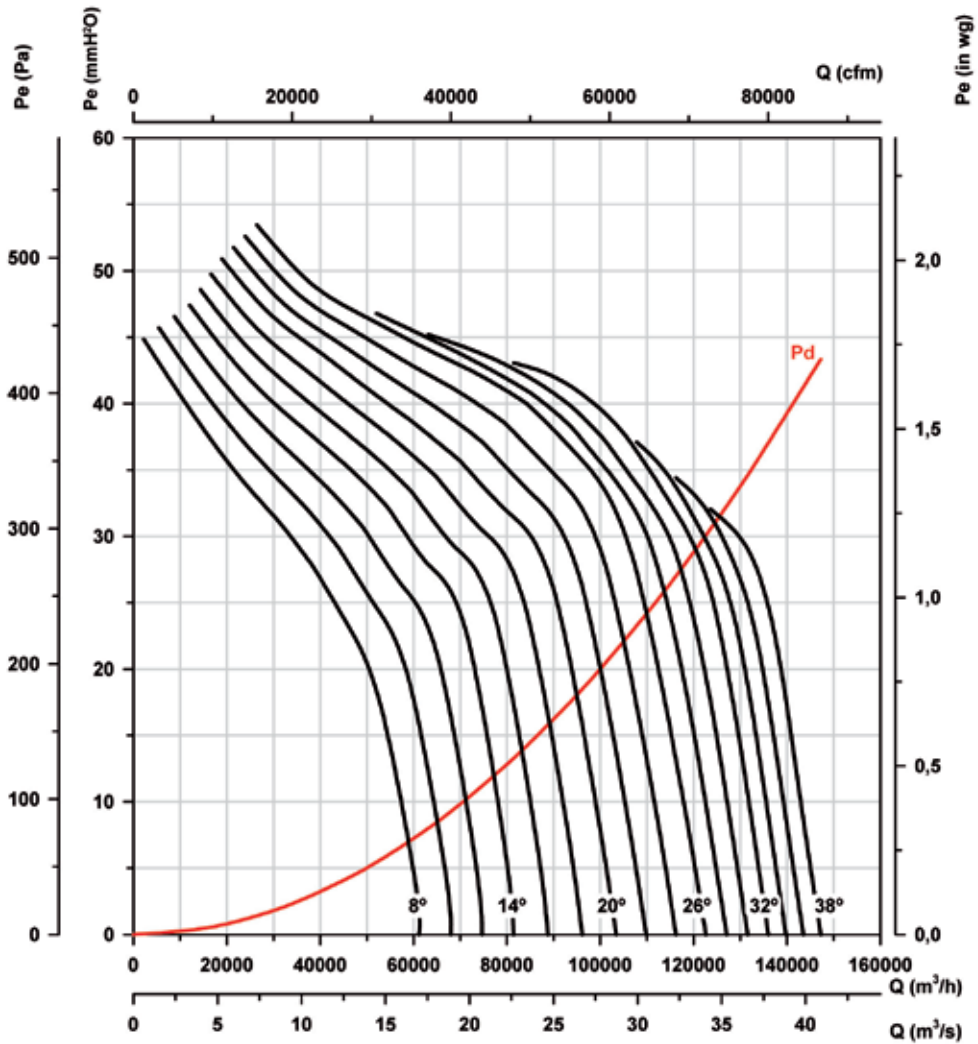

Absorbed power

Recommended Motor Power kW(hp)

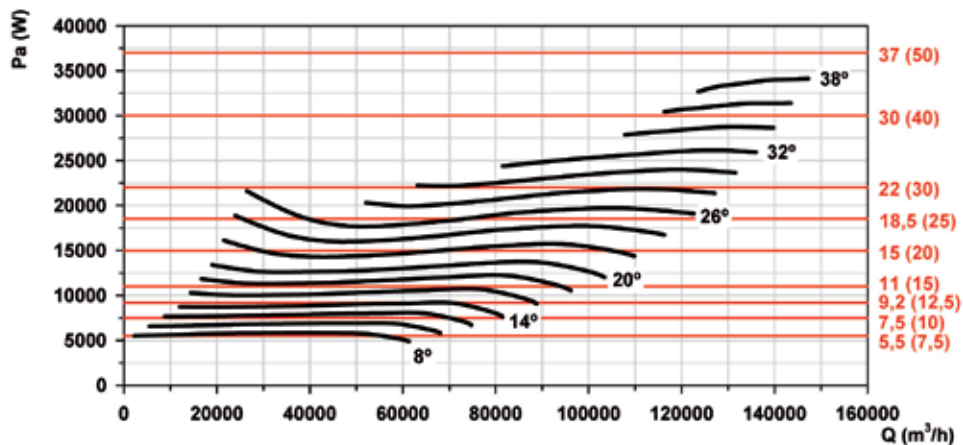

**Characteristic curves**

Q= Flow rate in m<sup>3</sup>/h, m<sup>3</sup>/s and cfm.

Pe= Static pressure in mmH<sub>2</sub>O, Pa and inwg.

**Rotor diameter (cm): 140**

**Number of poles: 6**

**Number of blades: 6**

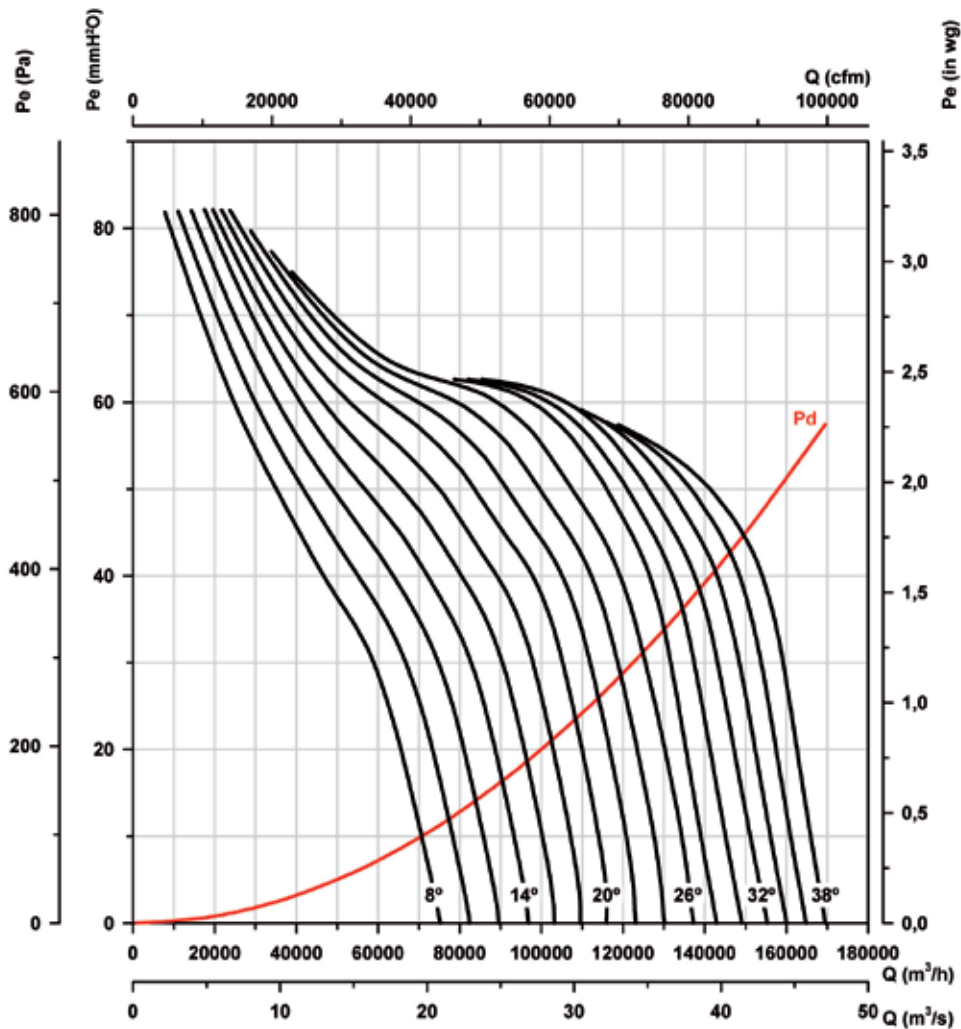

**Absorbed power**

**Recommended Motor Power kW(hp)**

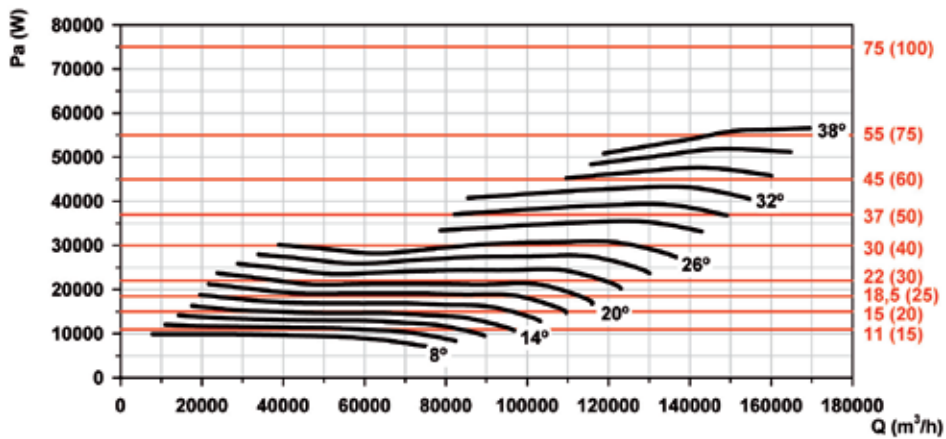

**Characteristic curves**

Q= Flow rate in m<sup>3</sup>/h, m<sup>3</sup>/s and cfm.

Pe= Static pressure in mmH<sub>2</sub>O, Pa and inwg.

**Rotor diameter (cm): 140**

**Number of poles: 6**

**Number of blades: 9**

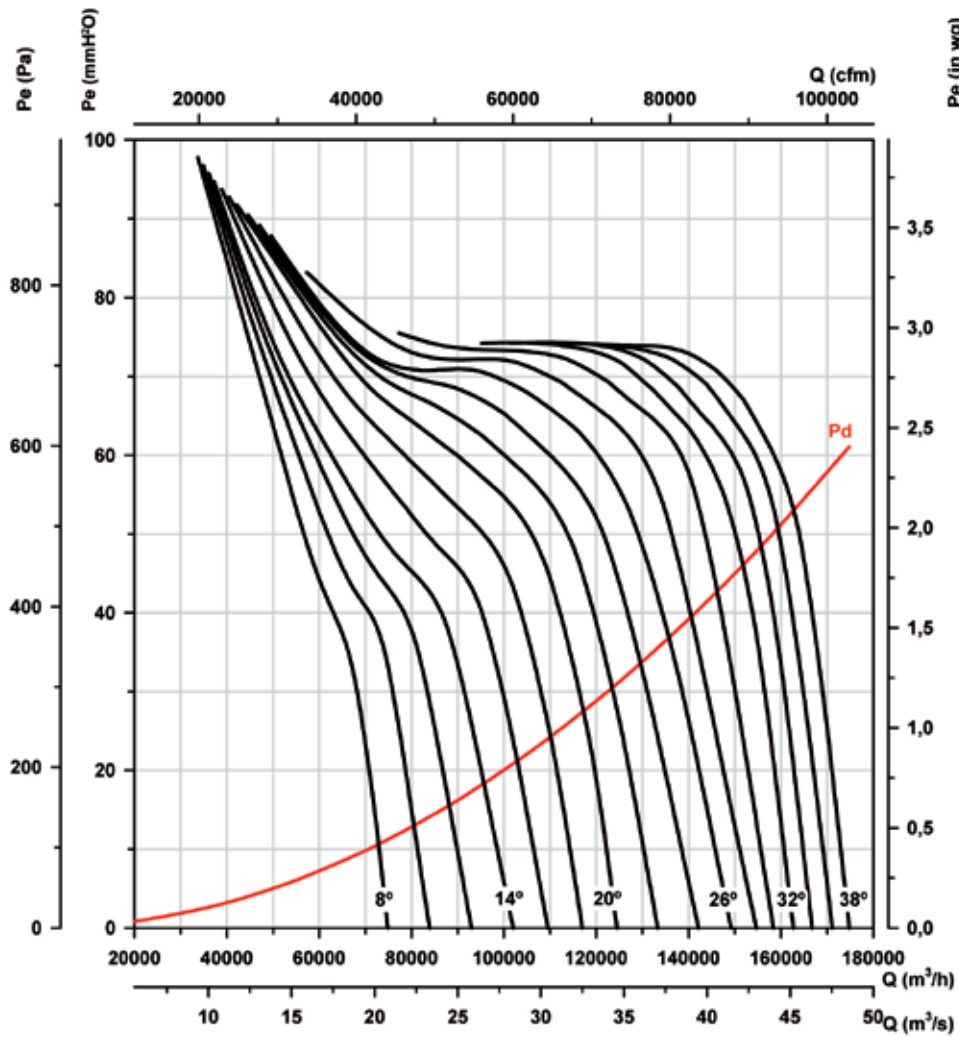

**Absorbed power**

**Recommended Motor Power kW(hp)**

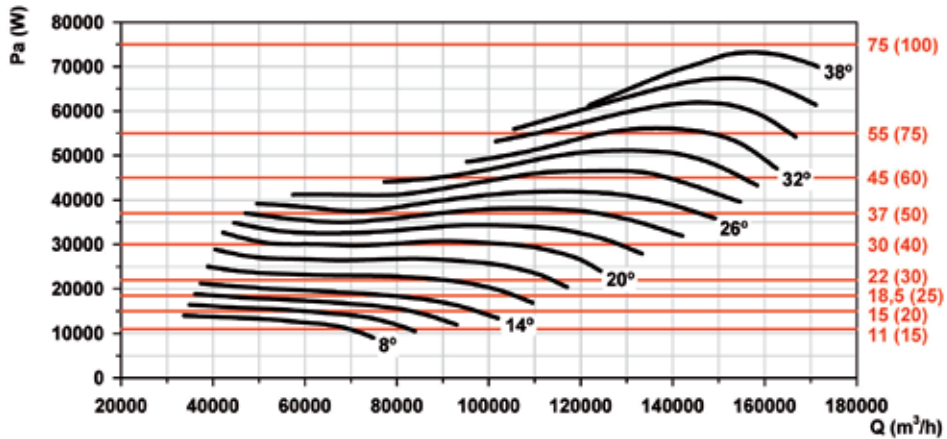

**Characteristic curves**

Q= Flow rate in m<sup>3</sup>/h, m<sup>3</sup>/s and cfm.

Pe= Static pressure in mmH<sub>2</sub>O, Pa and inwg.

**Rotor diameter (cm): 140**

**Number of poles: 8**

**Number of blades: 3**

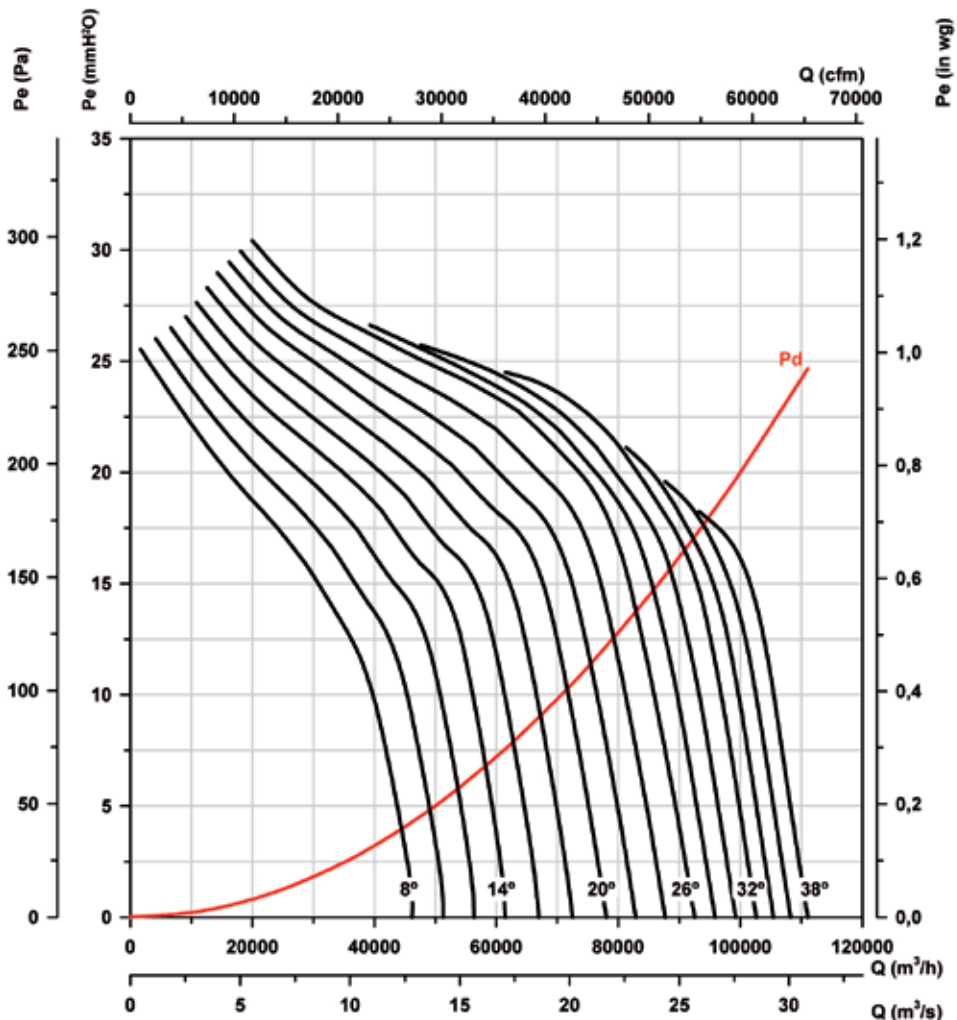

Absorbed power

Recommended Motor Power kW(hp)

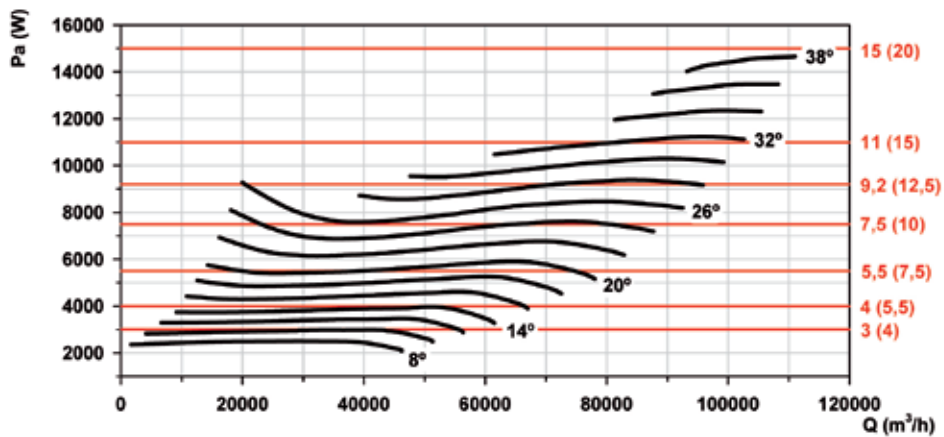

**Characteristic curves**

Q= Flow rate in m<sup>3</sup>/h, m<sup>3</sup>/s and cfm.

Pe= Static pressure in mmH<sub>2</sub>O, Pa and inwg.

**Rotor diameter (cm): 140**

**Number of poles: 8**

**Number of blades: 6**

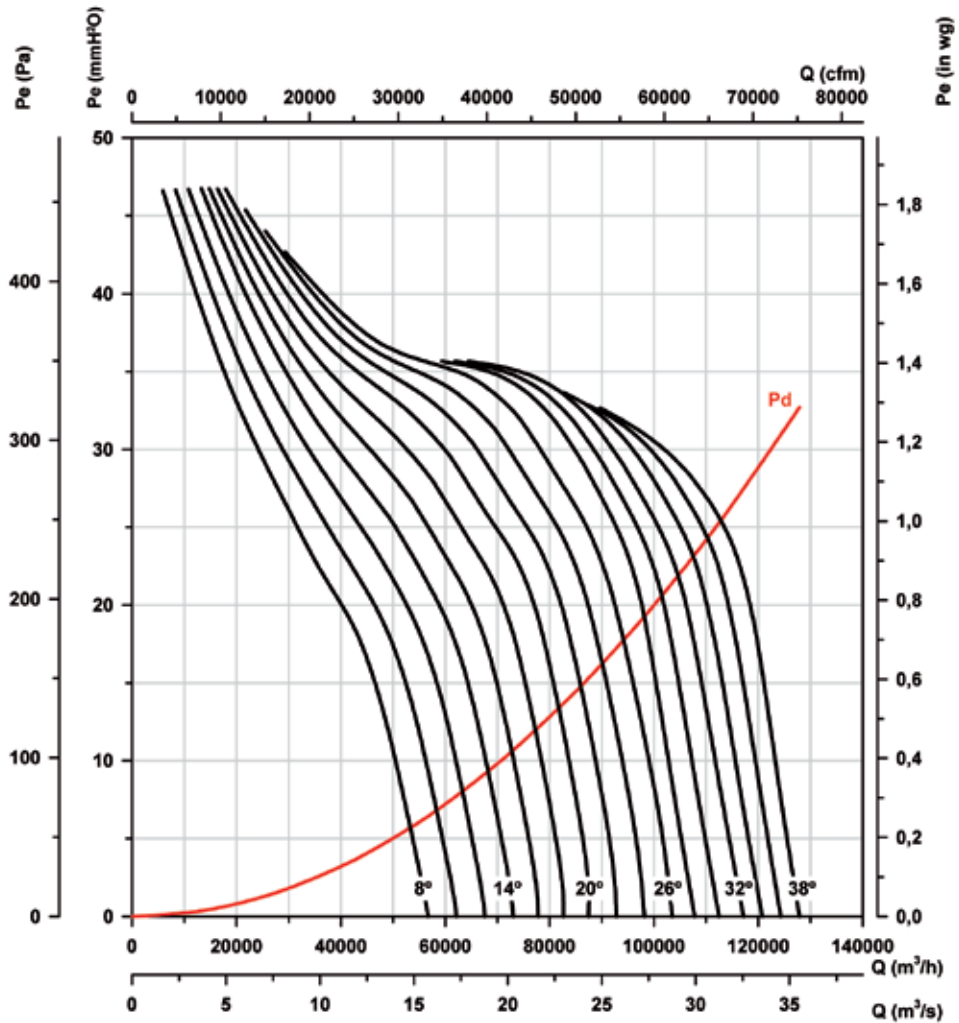

**Absorbed power**

**Recommended Motor Power kW(hp)**

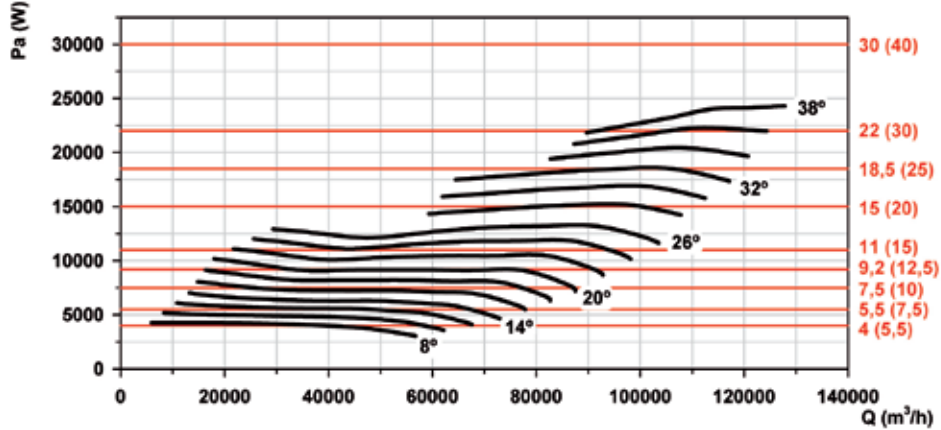

**Characteristic curves**

Q= Flow rate in m<sup>3</sup>/h, m<sup>3</sup>/s and cfm.

Pe= Static pressure in mmH<sub>2</sub>O, Pa and inwg.

**Rotor diameter (cm): 140**

**Number of poles: 8**

**Number of blades: 9**

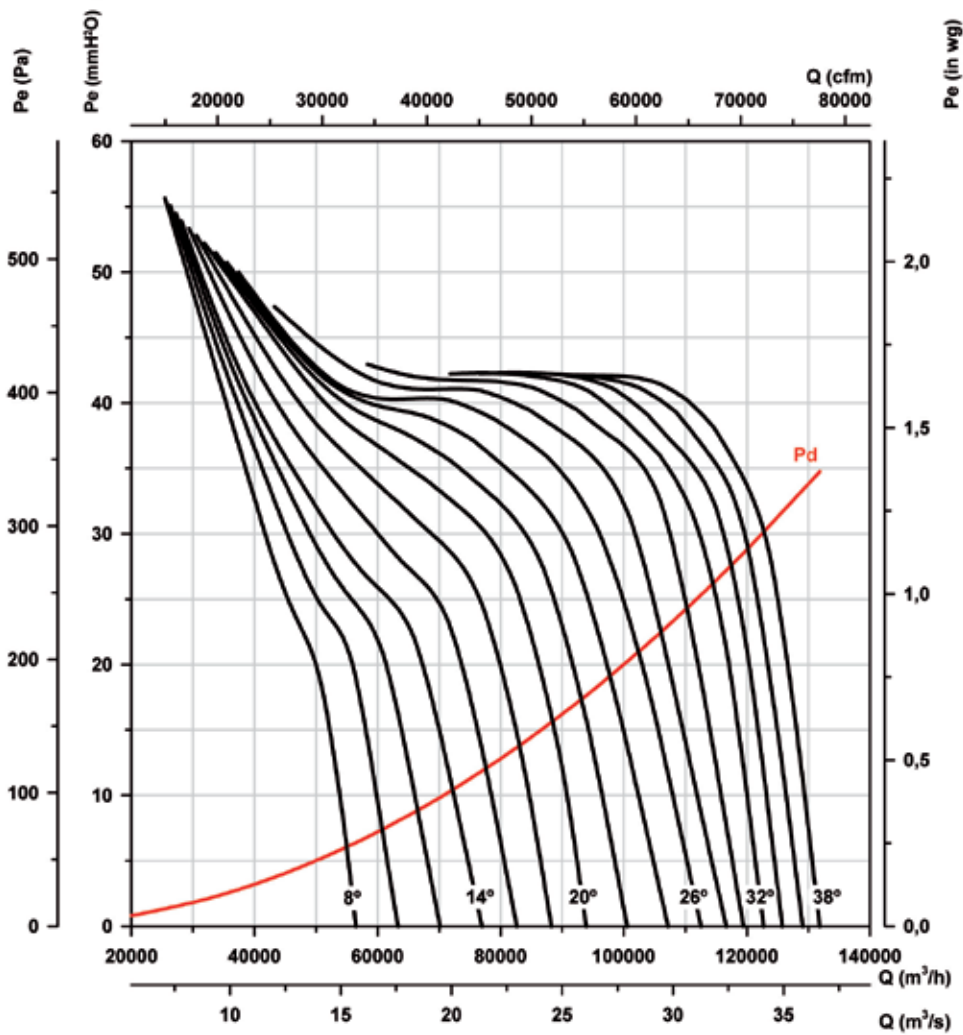

Absorbed power

Recommended Motor Power kW(hp)

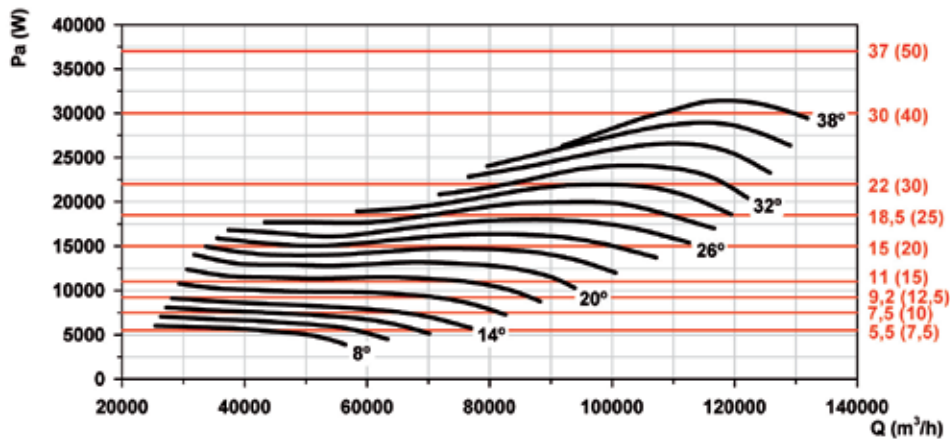

**Characteristic curves**

Q= Flow rate in m<sup>3</sup>/h, m<sup>3</sup>/s and cfm.

Pe= Static pressure in mmH<sub>2</sub>O, Pa and inwg.

**Rotor diameter (cm): 160**

**Number of poles: 6**

**Number of blades: 3**

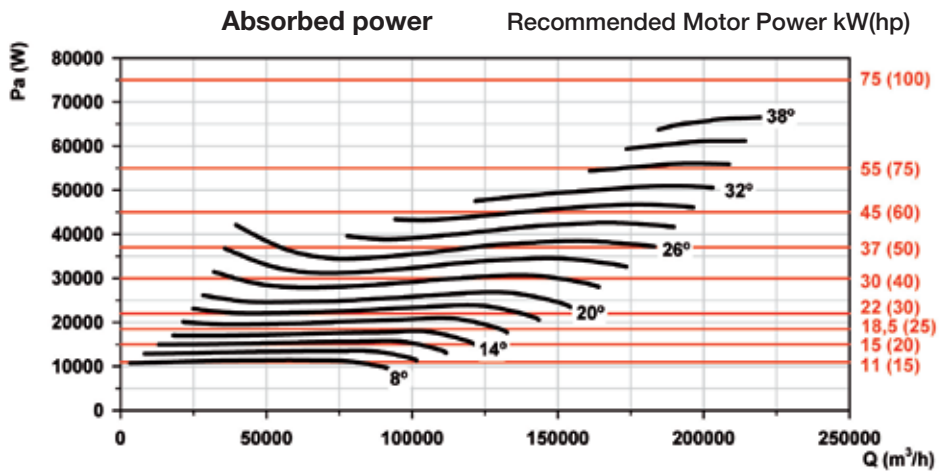
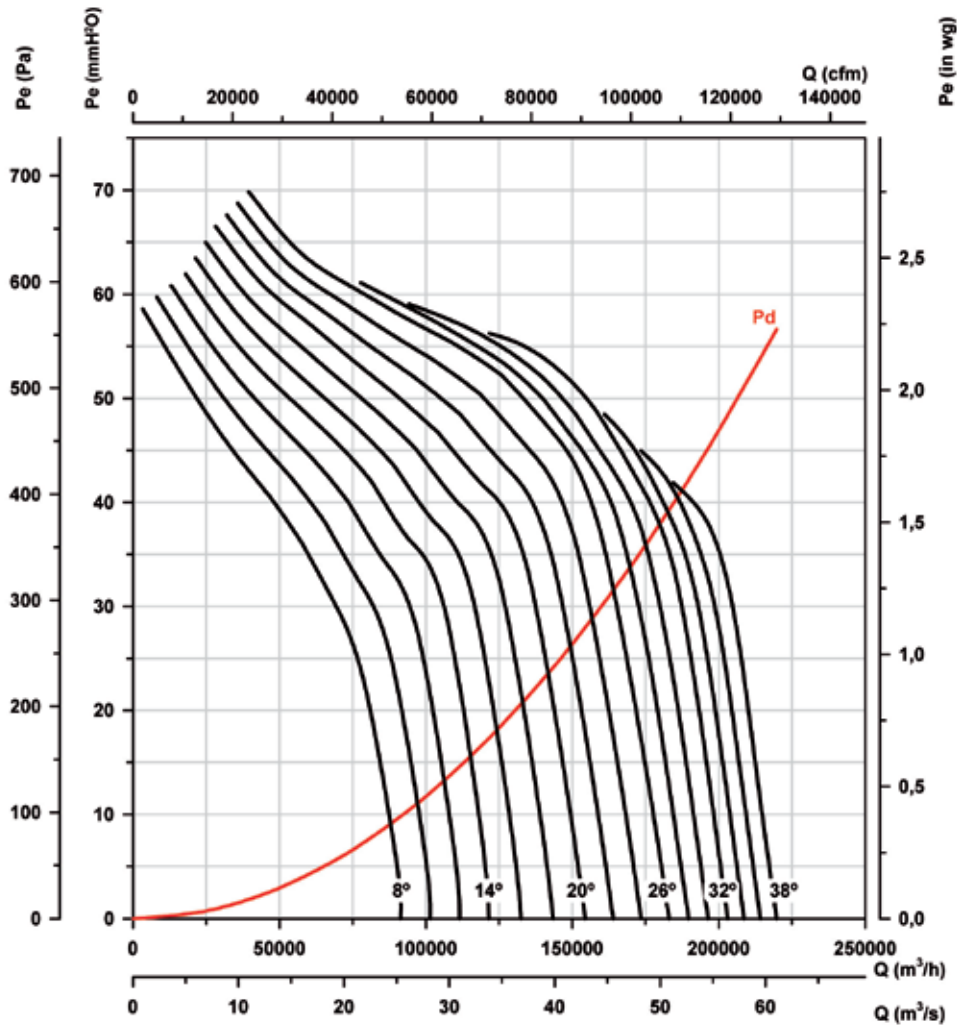

**Characteristic curves**

Q= Flow rate in m<sup>3</sup>/h, m<sup>3</sup>/s and cfm.

Pe= Static pressure in mmH<sub>2</sub>O, Pa and inwg.

**Rotor diameter (cm): 160**

**Number of poles: 6**

**Number of blades: 6**

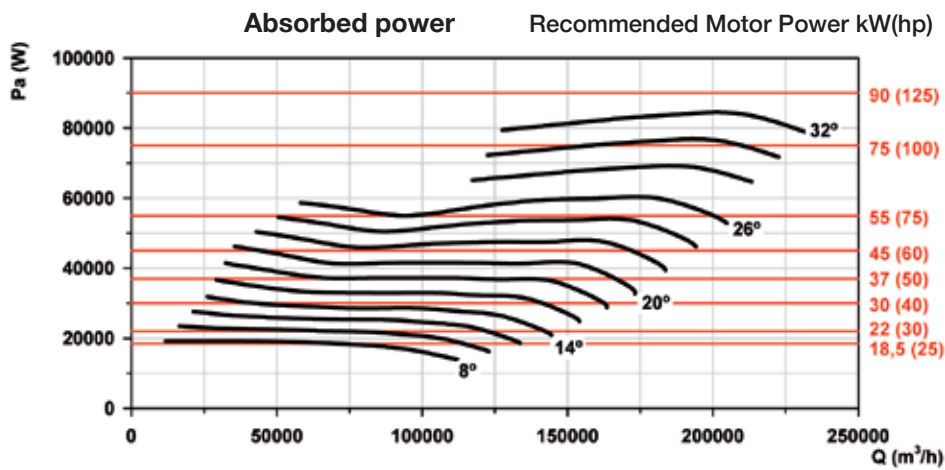
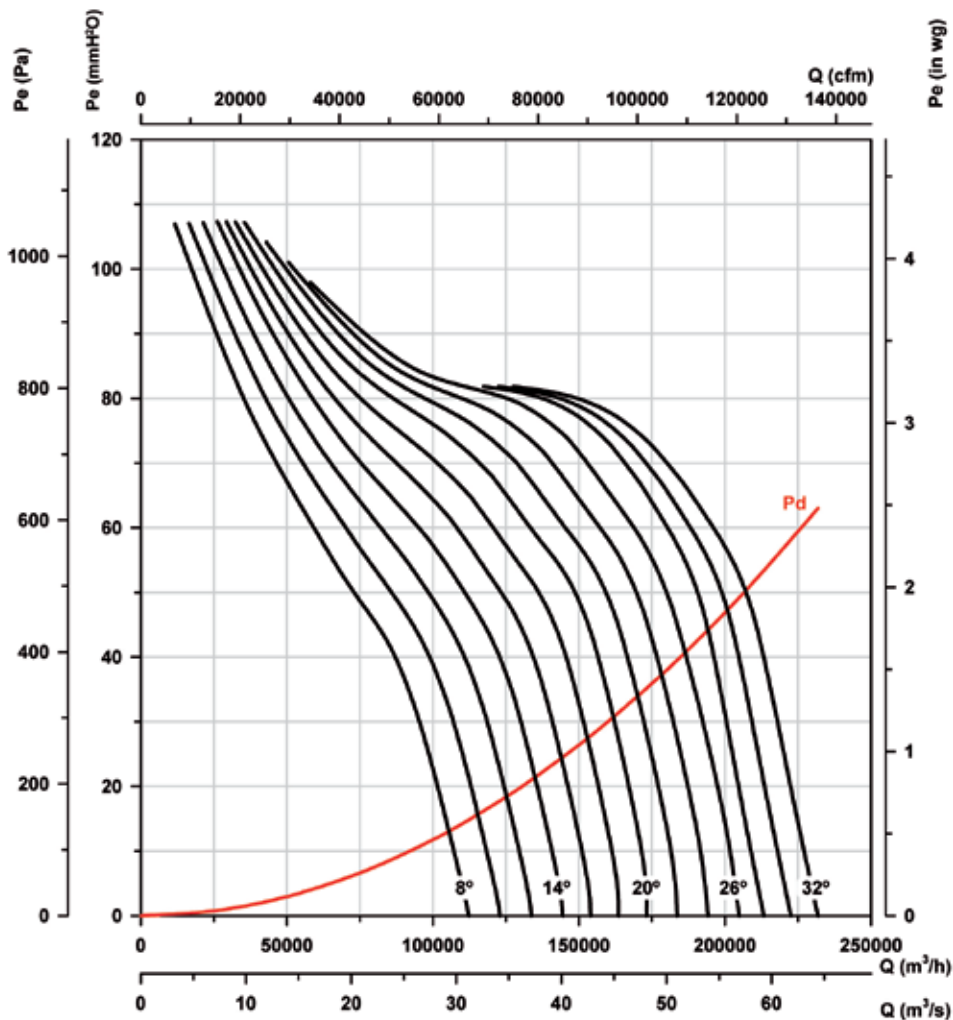



**Characteristic curves**

Q= Flow rate in m<sup>3</sup>/h, m<sup>3</sup>/s and cfm.

Pe= Static pressure in mmH<sub>2</sub>O, Pa and inwg.

**Rotor diameter (cm): 160**

**Number of poles: 6**

**Number of blades: 9**

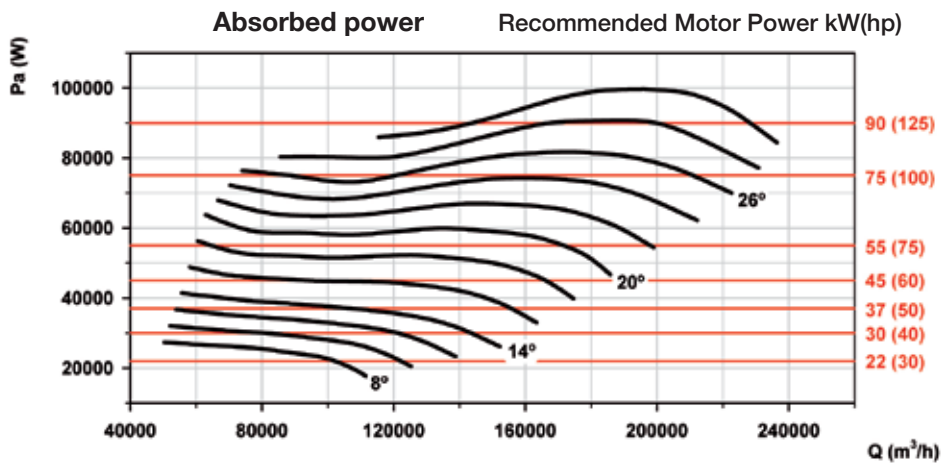
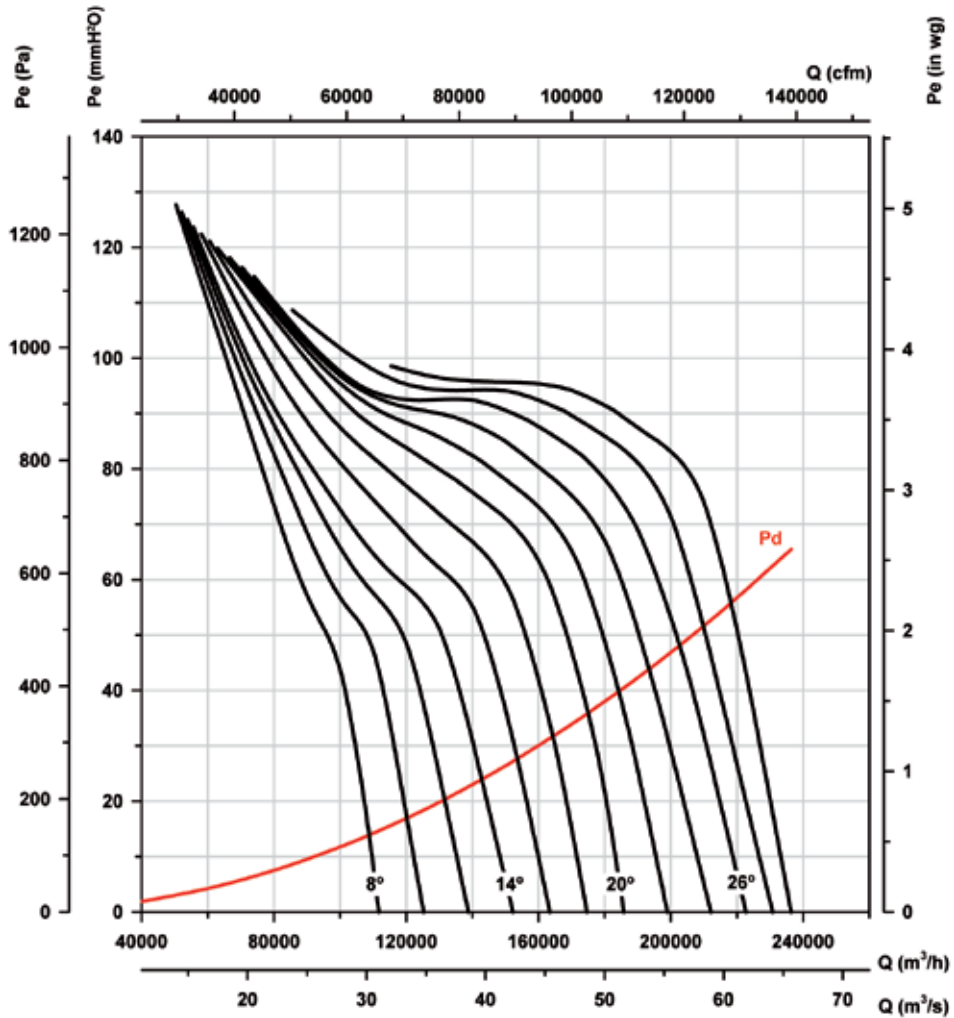

**Characteristic curves**

Q= Flow rate in m<sup>3</sup>/h, m<sup>3</sup>/s and cfm.

Pe= Static pressure in mmH<sub>2</sub>O, Pa and inwg.

**Rotor diameter (cm): 160**

**Number of poles: 8**

**Number of blades: 3**

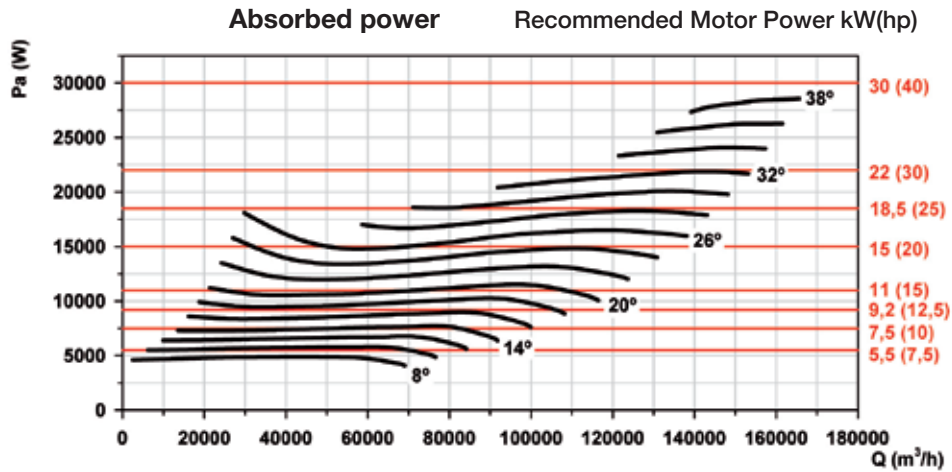
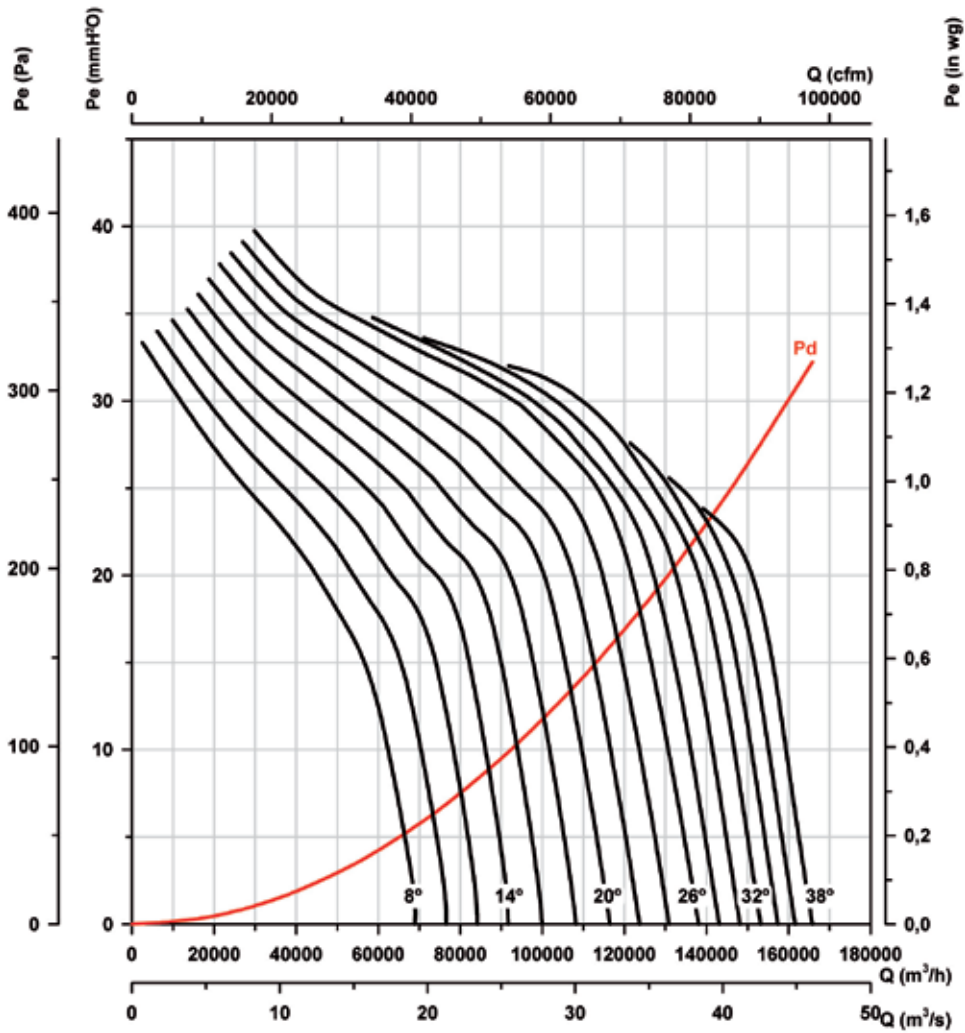

**Characteristic curves**

Q= Flow rate in m<sup>3</sup>/h, m<sup>3</sup>/s and cfm.

Pe= Static pressure in mmH<sub>2</sub>O, Pa and inwg.

**Rotor diameter (cm): 160**

**Number of poles: 8**

**Number of blades: 6**

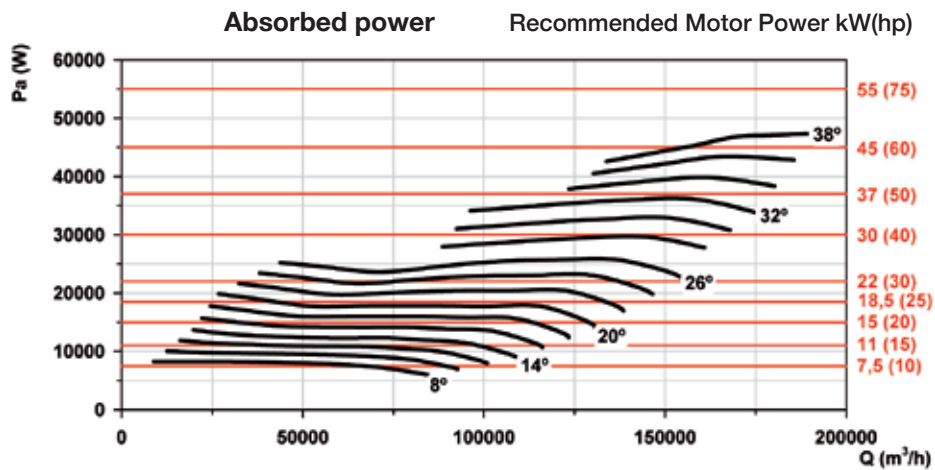
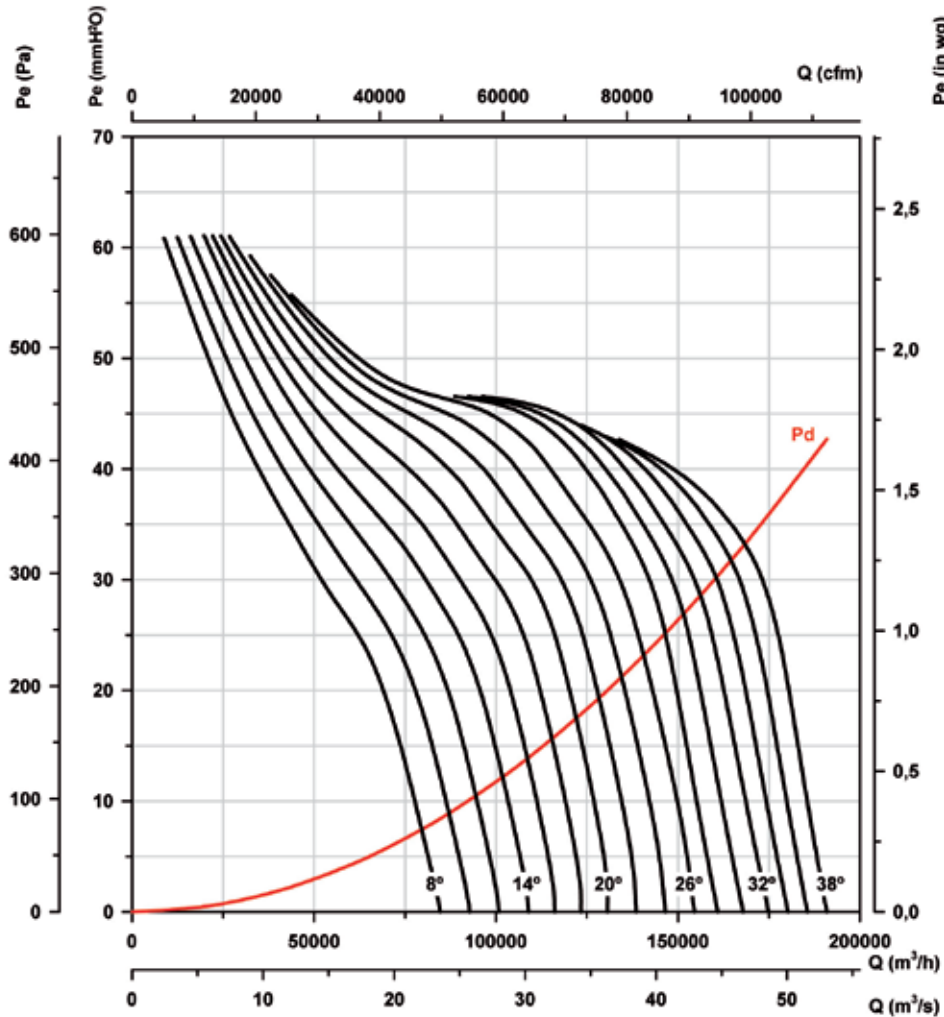

**Characteristic curves**

Q= Flow rate in m<sup>3</sup>/h, m<sup>3</sup>/s and cfm.

Pe= Static pressure in mmH<sub>2</sub>O, Pa and inwg.

**Rotor diameter (cm): 160**

**Number of poles: 8**

**Number of blades: 9**

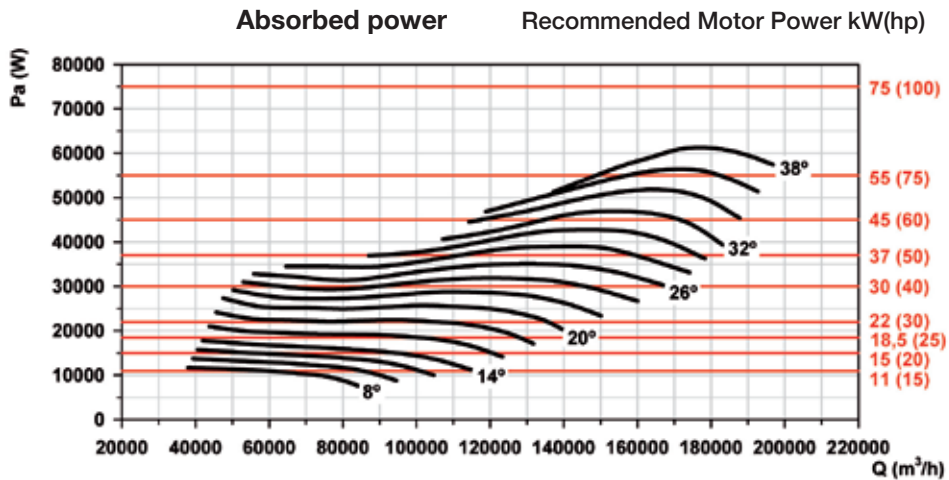
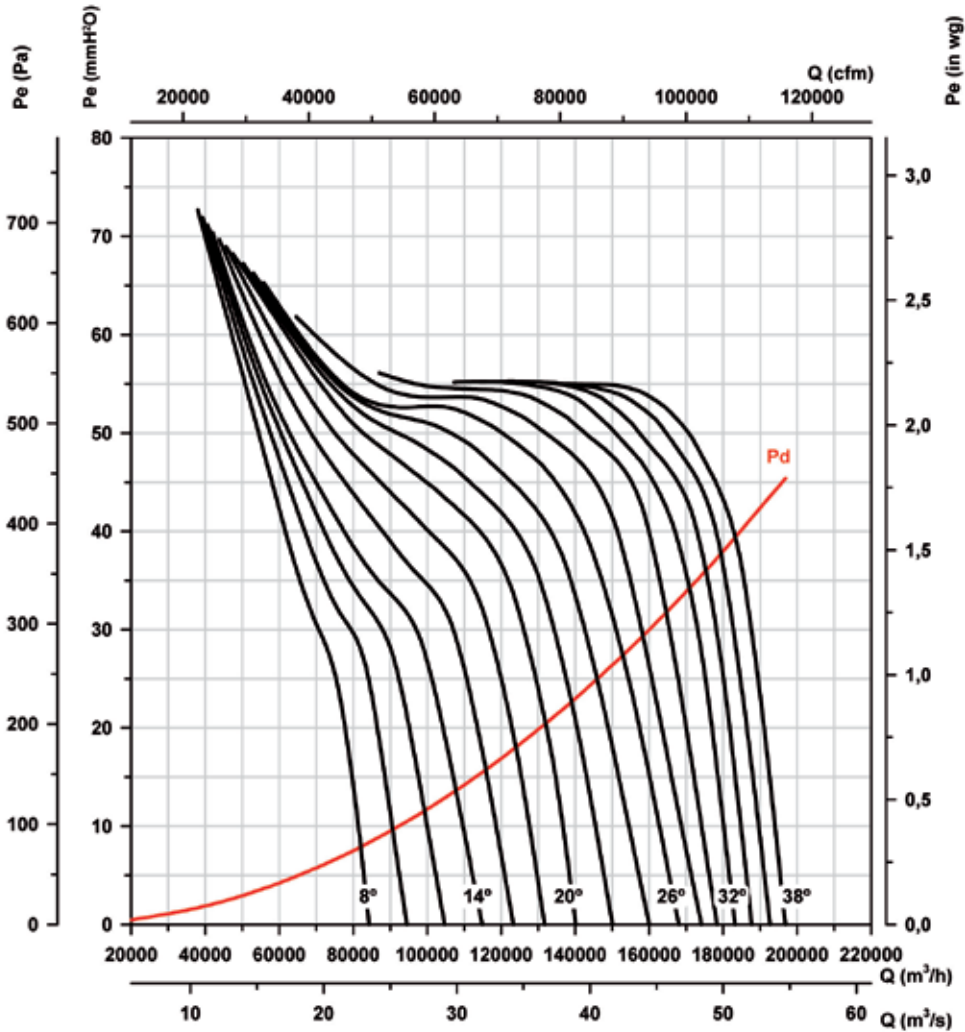

# CJTHT

## Axial fans 400°C/2h and 300°C/2h With soundproofed box

Extraction units with axial fans to work inside fire danger zones.



**Fan:**

- Sheet steel long casing fan.
- Galvanised sheet steel structure with thermal insulation and soundproofing.
- Variable angle impellers in cast aluminium.
- Approved in accordance with standard EN 12101-3, with certifications: 0370-CPR-0312 (F-400) and 0370-CPR-0974 (F-300).



**Motor:**

- Class H motors, ongoing use S1 and emergency use S2. With ball bearings, IP55 protection, and one- or two-speed depending on the model
- Multi voltage motor, special design valid for 220/380V 60Hz, 254/440V 60Hz, 265/460V 60Hz, 277/480V 60Hz.
- Maximum temperature of air to be carried: S1 continuous operation -20°C +40°C. S2 operation, 300°C/2h, 400°C/2h.

**On request:**

- Airflow direction from impeller to motor
- 100% reversible impellers.

**Finish:**

- Fan: Anti-corrosive finish in polyester resin, polymerised at 190°C after phosphate free pre-treatment
- Box: Anti-corrosive in galvanised sheet steel

### Order code

From size 40 to size 100

**CJTHT — 56 — 4T — T — 2 — F-400 — 60Hz**

CJTHT: 400°C/2h and 300°C/2h axial extraction units with soundproofed box

Impeller diameter in cm.

Number of motor pole  
2=2900 r/min. 50 Hz  
4=1400 r/min. 50 Hz  
6=900 r/min. 50 Hz  
8=750 r/min. 50 Hz  
12=500 r/min. 50 Hz

T=Three-phase

Motor power (HP)

F-300 Officially approved, tested for 300°C/2h  
F-400 Officially approved 400°C/2h

Size 125

**CJTHT — 125 — 4T / — 9-10 — 15 — F-400 — 60Hz**

CJTHT: 400°C/2h and 300°C/2h axial extraction units with soundproofed box

Impeller diameter in cm.

Number of motor pole  
2=2900 r/min. 50 Hz  
4=1400 r/min. 50 Hz  
6=900 r/min. 50 Hz  
8=750 r/min. 50 Hz  
12=500 r/min. 50 Hz

T=Three-phase

Number of blades  
3 blades  
6 blades  
9 blades

Angle of inclination of the blades

Motor power (HP)

F-300 Officially approved, tested for 300°C/2h  
F-400 Officially approved 400°C/2h

### Technical characteristics

Model	Speed (r/min)	Maximum admissible current (A)		Power installed (kW)	Tilting angle blades (°)	Airflow maximum (m³/h)	Sound pressure level dB(A)	Approx. weight (Kg)
		220-277 V	380-480 V					
CJTHT-40-2/4T-1.5	3451 / 1708		2,98 / 1,07	1,10 / 0,25	6750/3400	73 / 58	50	
CJTHT-40-2/4T-2	3499 / 1737		4,47 / 1,40	1,50 / 0,37	7350/3650	74 / 59	51	
CJTHT-40-4T-0.75	1690	2,72	1,57	0,55	5800	61	41	
CJTHT-40-6T-0.75	1107	3,12	1,80	0,55	3800	51	49	
CJTHT-40-6/12T-0.75	1107 / 536		1,75 / 0,67	0,55 / 0,09	3800/1750	51 / 36	53	
CJTHT-45-2/4T-2	3499 / 1737		4,47 / 1,40	1,50 / 0,37	8800/4400	75 / 60	53	
CJTHT-45-2/4T-3	3487 / 1720		5,73 / 1,48	2,20 / 0,50	11300/5650	77 / 62	55	
CJTHT-45-4T-0.75	1690	2,72	1,57	0,55	7500	65	43	
CJTHT-45-6T-0.75	1107	3,12	1,80	0,55	6050	53	51	
CJTHT-45-6/12T-0.75	1107 / 536		1,75 / 0,67	0,55 / 0,09	6050/2800	53 / 38	55	
CJTHT-50-2/4T-4	3463 / 1714		6,91 / 2,14	3,00 / 0,80	12100/6050	79 / 64	62	
CJTHT-50-2/4T-6	3469 / 1720		10,38 / 3,39	4,50 / 1,30	15400/7700	80 / 65	78	
CJTHT-50-4T-1	1678	3,02	1,74	0,75	8950	66	50	
CJTHT-50-6T-0.75	1107	3,12	1,80	0,55	9150	55	52	
CJTHT-50-6/12T-0.75	1107 / 536		1,75 / 0,67	0,55 / 0,09	9150/4250	55 / 40	56	
CJTHT-56-2/4T-6	3469 / 1720		10,38 / 3,39	4,50 / 1,30	19650/9800	85 / 69	87	
CJTHT-56-2/4T-12	3469 / 1708		18,73 / 5,74	9,20 / 2,50	27000/13500	86 / 71	153	
CJTHT-56-4T-1	1678	3,02	1,74	0,75	10550	70	59	
CJTHT-56-4T-1.5	1690	4,83	2,79	1,10	12750	71	61	
CJTHT-56-4/8T-1.5	1720 / 839		2,99 / 1,04	1,10 / 0,25	12750/6300	71 / 56	65	
CJTHT-56-4T-2	1696	6,29	3,63	1,50	15000	72	63	
CJTHT-56-4/8T-2	1684 / 839		3,73 / 1,72	1,50 / 0,37	15000/7400	72 / 57	69	
CJTHT-56-6T-0.75	1107	3,12	1,80	0,55	10650	60	61	
CJTHT-56-6/12T-0.75	1107 / 536		1,75 / 0,67	0,55 / 0,09	10650/4950	60 / 45	65	
CJTHT-63-4T-1	1678	3,02	1,74	0,75	13800	70	63	
CJTHT-63-4T-1.5	1690	4,83	2,79	1,10	16550	71	66	
CJTHT-63-4/8T-1.5	1720 / 839		2,99 / 1,04	1,10 / 0,25	16550/8200	71 / 56	69	
CJTHT-63-4T-2	1696	6,29	3,63	1,50	19100	72	67	
CJTHT-63-4/8T-2	1684 / 839		3,73 / 1,72	1,50 / 0,37	19100/9450	72 / 57	74	
CJTHT-63-4T-3	1726	8,68	5,01	2,20	22400	73	73	
CJTHT-63-4/8T-3	1702 / 839		4,93 / 1,82	2,20 / 0,45	22400/11050	73 / 58	87	
CJTHT-63-4T-4	1714	11,11	6,42	3,00	25150	74	78	
CJTHT-63-4/8T-4	1714 / 853		6,71 / 2,40	3,00 / 0,60	25150/12450	74 / 59	91	
CJTHT-63-6T-0.75	1107	3,12	1,80	0,55	14650	63	66	
CJTHT-63-6/12T-0.75	1107 / 536		1,75 / 0,67	0,55 / 0,09	14650/6800	63 / 48	69	
CJTHT-63-6T-1	1119	3,58	2,07	0,75	15900	64	67	
CJTHT-63-6/12T-1	1113 / 518		2,39 / 1,14	0,75 / 0,15	15900/7400	64 / 49	71	
CJTHT-71-4T-1.5	1690	4,83	2,79	1,10	19950	75	82	
CJTHT-71-4/8T-1.5	1720 / 839		2,99 / 1,04	1,10 / 0,25	19950/9850	75 / 60	86	
CJTHT-71-4T-2	1696	6,29	3,63	1,50	19950	76	84	
CJTHT-71-4/8T-2	1684 / 839		3,73 / 1,72	1,50 / 0,37	19950/9850	76 / 61	91	
CJTHT-71-4T-3	1726	8,68	5,01	2,20	25250	78	90	
CJTHT-71-4/8T-3	1702 / 839		4,93 / 1,82	2,20 / 0,45	25250/12450	78 / 63	103	
CJTHT-71-4T-4	1714	11,11	6,42	3,00	28100	79	95	
CJTHT-71-4/8T-4	1714 / 853		6,71 / 2,40	3,00 / 0,60	28100/13900	79 / 64	108	
CJTHT-71-6T-0.75	1107	3,12	1,80	0,55	15400	65	82	
CJTHT-71-6/12T-0.75	1107 / 536		1,75 / 0,67	0,55 / 0,09	15400/7150	65 / 50	86	
CJTHT-71-6T-1	1119	3,58	2,07	0,75	17450	66	84	
CJTHT-71-6/12T-1	1113 / 518		2,39 / 1,14	0,75 / 0,15	17450/8100	66 / 51	87	
CJTHT-71-6T-1.5	1119	5,1	2,95	1,10	20300	67	86	
CJTHT-71-6/12T-1.5	1131 / 559		3,30 / 1,32	1,10 / 0,18	20300/9450	67 / 52	97	
CJTHT-80-4T-3	1726	8,68	5,01	2,20	25050	79	98	
CJTHT-80-4/8T-3	1702 / 839		4,93 / 1,82	2,20 / 0,45	25050/12400	79 / 64	111	

**Technical characteristics**

Model	Speed (r/min)	Maximum admissible current		Power installed (kW)	Tilting angle blades (°)	Airflow maximum (m³/h)	Sound pressure level dB(A)	Approx. weight (Kg)
		(A)						
		220-277 V	380-480 V					
CJTHT-80-4T-4	1714	11,11	6,42	3,00	27850	80	103	
CJTHT-80-4/8T-4	1714 / 853		6,71 / 2,40	3,00 / 0,60	27850/13750	80 / 65	115	
CJTHT-80-4T-5.5	1708		8,56	4,00	33450	81	113	
CJTHT-80-4/8T-5.5	1726 / 857		9,36 / 2,88	4,00 / 0,80	33450/16550	81 / 66	147	
CJTHT-80-6T-1.5	1119	5,1	2,95	1,10	20100	70	95	
CJTHT-80-6/12T-1.5	1131 / 559		3,30 / 1,32	1,10 / 0,18	20100/9350	70 / 55	105	
CJTHT-80-6T-2	1125	6,81	3,93	1,50	23900	71	99	
CJTHT-80-6/12T-2	1154 / 559		4,43 / 1,65	1,50 / 0,25	23900/11100	71 / 56	113	
CJTHT-80-6T-3	1131	11,11	6,42	2,20	30150	72	113	
CJTHT-80-6/12T-3	1119 / 559		6,24 / 2,39	2,20 / 0,37	30150/14000	72 / 57	118	
CJTHT-80-8T-0.75	821	3,57	2,06	0,55	16550	68	99	
CJTHT-80-8T-1	833	4,87	2,81	0,75	19550	69	111	
CJTHT-90-4T-4	1714	11,11	6,42	3,00	34700	84	127	
CJTHT-90-4/8T-4	1714 / 853		6,71 / 2,40	3,00 / 0,60	34700/17150	84 / 69	139	
CJTHT-90-4T-5.5	1708		8,56	4,00	39900	86	137	
CJTHT-90-4/8T-5.5	1726 / 857		9,36 / 2,88	4,00 / 0,80	39900/19700	86 / 71	171	
CJTHT-90-4T-7.5	1726		12,09	5,50	43350	88	171	
CJTHT-90-4/8T-7.5	1726 / 857		12,42 / 3,59	5,50 / 1,10	43350/21450	88 / 73	190	
CJTHT-90-4T-10	1737		16,28	7,50	50000	89	208	
CJTHT-90-4/8T-9	1726 / 857		17,16 / 4,89	7,50 / 1,50	46850/23150	89 / 74	198	
CJTHT-90-6T-2	1125	6,81	3,93	1,50	28400	75	123	
CJTHT-90-6/12T-2	1154 / 559		4,43 / 1,65	1,50 / 0,25	28400/13200	75 / 60	137	
CJTHT-90-6T-3	1131	11,11	6,42	2,20	32750	76	137	
CJTHT-90-6/12T-3	1119 / 559		6,24 / 2,39	2,20 / 0,37	32750/15250	76 / 61	142	
CJTHT-90-6T-4	1142	13,42	7,75	3,00	38150	77	171	
CJTHT-90-6/12T-4	1142 / 571		7,85 / 2,81	3,00 / 0,55	38150/17750	77 / 62	171	
CJTHT-90-8T-1	833	4,87	2,81	0,75	23150	69	135	
CJTHT-90-8T-2	833	7,21	4,16	1,50	29850	71	139	
CJTHT-90-8T-3	857	9,67	5,58	2,20	35350	72	171	
CJTHT-100-4T-7.5	1726		12,09	5,50	51700	89	179	
CJTHT-100-4/8T-7.5	1726 / 857		12,42 / 3,59	5,50 / 1,10	46950/23200	89 / 74	198	
CJTHT-100-4T-10	1737		16,28	7,50	56400	90	216	
CJTHT-100-4/8T-9	1726 / 857		17,16 / 4,89	7,50 / 1,50	56400/27900	90 / 75	206	
CJTHT-100-4T-15	1743		23,48	11,00	65850	91	251	
CJTHT-100-4/8T-15	1749 / 863		24,47 / 8,96	11,00 / 2,80	65850/32550	91 / 76	251	
CJTHT-100-4T-20	1749		31,62	15,00	72500	92	258	
CJTHT-100-4/8T-20	1749 / 863		33,24 / 13,58	15,00 / 3,80	72500/35850	92 / 77	258	
CJTHT-100-6T-3	1131	11,11	6,42	2,20	36950	80	145	
CJTHT-100-6/12T-3	1119 / 559		6,24 / 2,39	2,20 / 0,37	36950/17200	80 / 65	150	
CJTHT-100-6T-4	1142	13,42	7,75	3,00	43150	81	179	
CJTHT-100-6/12T-4	1142 / 571		7,85 / 2,81	3,00 / 0,55	43150/20050	81 / 66	179	
CJTHT-100-6T-5.5	1142		10,17	4,00	47500	82	187	
CJTHT-100-6/12T-5.5	1154 / 571		10,60 / 3,25	4,00 / 0,65	47500/22100	82 / 67	206	
CJTHT-100-8T-2	833	7,21	4,16	1,50	32550	75	147	
CJTHT-100-8T-3	857	9,67	5,58	2,20	37450	75	179	
CJTHT-100-8T-4	857	12,78	7,38	3,00	43400	76	216	
CJTHT-125-4T/3-10	1737		16,28	7,50	54400	85	395	
CJTHT-125-4/8T/3-9	1726 / 857		17,16 / 4,89	7,50 / 1,50	50550/25000	85 / 65	409	
CJTHT-125-4T/3-15	1743		23,48	11,00	69800	86	450	
CJTHT-125-4/8T/3-15	1749 / 863		24,47 / 8,96	11,00 / 2,80	69800/34500	86 / 66	456	
CJTHT-125-4T/3-20	1749		31,62	15,00	77500	88	457	
CJTHT-125-4/8T/3-20	1749 / 863		33,24 / 13,58	15,00 / 3,80	77500/38300	88 / 68	476	
CJTHT-125-4T/3-25	1749		36,58	18,50	92950	88	540	

### Technical characteristics

Model	Speed (r/min)	Maximum admissible current (A)		Power installed (kW)	Tilting angle blades (°)	Airflow maximum (m³/h)	Sound pressure level dB(A)	Approx. weight (Kg)
		220-277 V	380-480 V					
CJTHT-125-4T/3-30	1743 / 863		42,63 / 16,24	22,00 / 5,30	101300	89	545	
CJTHT-125-4/8T/3-27	1749		44,02	22,00	92950/45950	89 / 68	548	
CJTHT-125-4/8T/3-37	1770 / 882		51,00 / 0,60	27,00 / 6,00	118000/58350	90 / 69	625	
CJTHT-125-4T/3-40	1755		58,24	30,00	118000	90	598	
CJTHT-125-4/8T/3-40	1755 / 875		58,87 / 21,24	30,00 / 7,50	118000/58350	90 / 69	638	
CJTHT-125-4T/6-20	1749		31,62	15,00	69250	86	466	
CJTHT-125-4/8T/6-20	1749 / 863		33,24 / 13,58	15,00 / 3,80	73400/36250	86 / 65	485	
CJTHT-125-4/8T/6-22	1749 / 863		33,24 / 13,58	15,00 / 3,80	77500/38300	86 / 66	555	
CJTHT-125-4T/6-25	1749		36,58	18,50	81600	87	549	
CJTHT-125-4/8T/6-27	1749		44,02	22,00	85750/42350	87 / 66	557	
CJTHT-125-4T/6-30	1743 / 863		42,63 / 16,24	22,00 / 5,30	93950	87	554	
CJTHT-125-4/8T/6-37	1770 / 882		51,00 / 0,60	27,00 / 6,00	102200/50500	87 / 67	633	
CJTHT-125-4T/6-40	1755		58,24	30,00	110400	89	606	
CJTHT-125-4/8T/6-40	1755 / 875		58,87 / 21,24	30,00 / 7,50	110400/54600	89 / 68	646	
CJTHT-125-4T/6-50	1770		70,60	37,00	117700	90	734	
CJTHT-125-4T/9-25	1749		36,58	18,50	69850	85	558	
CJTHT-125-4/8T/9-22	1749 / 863		33,24 / 13,58	15,00 / 3,80	59500/29400	85 / 66	564	
CJTHT-125-4T/9-30	1743 / 863		42,63 / 16,24	22,00 / 5,30	85350	86	563	
CJTHT-125-4/8T/9-27	1749		44,02	22,00	75000	86 / 67	566	
CJTHT-125-4/8T/9-37	1770 / 882		51,00 / 0,60	27,00 / 6,00	85350/42200	87 / 67	642	
CJTHT-125-4T/9-40	1755		58,24	30,00	95700	88	615	
CJTHT-125-4/8T/9-40	1755 / 875		58,87 / 21,24	30,00 / 7,50	95700/47300	88 / 68	655	
CJTHT-125-4T/9-50	1770		70,60	37,00	106050	90	743	
CJTHT-125-6T/3-4	1142	13,42	7,75	3,00	35650	77	385	
CJTHT-125-6/12T/3-4	1142 / 571		7,85 / 2,81	3,00 / 0,55	40700/18900	77 / 62	401	
CJTHT-125-6T/3-5.5	1142		10,17	4,00	50800	78	393	
CJTHT-125-6/12T/3-5.5	1154 / 571		10,60 / 3,25	4,00 / 0,65	50800/23600	78 / 63	432	
CJTHT-125-6T/3-7.5	1142		13,56	5,50	60900	79	401	
CJTHT-125-6/12T/3-7.5	1154 / 571		14,40 / 4,77	5,50 / 1,00	60900/28300	79 / 64	445	
CJTHT-125-6T/3-10	1142		18,24	7,50	71850	81	449	
CJTHT-125-6/12T/3-10	1160 / 577		17,82 / 6,74	7,50 / 1,50	71850/33400	81 / 66	457	
CJTHT-125-6T/3-15	1136		23,38	11,00	91650	82	466	
CJTHT-125-6/12T/3-15	1154 / 559		26,31 / 9,57	11,00 / 2,20	91650/42600	82 / 67	557	
CJTHT-125-6T/3-20	1154		31,14	15,00	101650	83	533	
CJTHT-125-6/12T/3-24	1160 / 577		34,71 / 10,46	15,00 / 2,50	104450/48550	83 / 68	623	
CJTHT-125-6T/6-5.5	1142		10,17	4,00	45400	75	402	
CJTHT-125-6/12T/6-5.5	1154 / 571		10,60 / 3,25	4,00 / 0,65	50750/23600	75 / 60	441	
CJTHT-125-6T/6-7.5	1142		13,56	5,50	56150	75	410	
CJTHT-125-6/12T/6-7.5	1154 / 571		14,40 / 4,77	5,50 / 1,00	56150/26100	75 / 60	454	
CJTHT-125-6T/6-10	1142		18,24	7,50	66950	77	458	
CJTHT-125-6/12T/6-10	1160 / 577		17,82 / 6,74	7,50 / 1,50	66950/31150	77 / 62	466	
CJTHT-125-6T/6-15	1136		23,38	11,00	81900	79	475	
CJTHT-125-6/12T/6-15	1154 / 559		26,31 / 9,57	11,00 / 2,20	81900/38100	79 / 64	566	
CJTHT-125-6T/6-20	1154		31,14	15,00	91950	80	542	
CJTHT-125-6/12T/6-24	1160 / 577		34,71 / 10,46	15,00 / 2,50	102550/47700	80 / 65	631	
CJTHT-125-6T/9-10	1142		18,24	7,50	55900	76	467	
CJTHT-125-6/12T/9-10	1160 / 577		17,82 / 6,74	7,50 / 1,50	55900/26000	76 / 61	475	
CJTHT-125-6T/9-15	1136		23,38	11,00	76250	79	484	
CJTHT-125-6/12T/9-15	1154 / 559		26,31 / 9,57	11,00 / 2,20	76250/35450	79 / 64	575	
CJTHT-125-6T/9-20	1154		31,14	15,00	87450	82	551	
CJTHT-125-6/12T/9-24	1160 / 577		34,71 / 10,46	15,00 / 2,50	93050/43250	82 / 67	640	



## Acoustic features

The specified values are determined according to free field measurements of pressure and sound levels in dB(A) at an equivalent distance of twice the fan's span plus the impeller's diameter, with a minimum of 1.5 m.

Sound power Lw(A) spectrum in dB(A) via frequency band in Hz.

Model	63	125	250	500	1000	2000	4000	8000	Model	63	125	250	500	1000	2000	4000	8000
40-2-1,5	45	66	73	78	81	77	70	59	90-8-3	50	64	71	76	79	75	68	57
40-4-1,5 (2V)	30	51	58	63	66	62	55	44	100-4-7,5	62	82	90	95	97	94	87	76
40-2-2	46	67	74	79	82	78	71	60	100-8-7,5 (2V)	47	67	75	80	82	79	72	61
40-4-2 (2V)	31	52	59	64	67	63	56	45	100-4-10	60	80	88	93	95	92	85	74
40-4-0,75	33	54	61	66	69	65	58	47	100-4-9	61	81	89	94	96	93	86	75
40-6	23	44	51	56	59	55	48	37	100-8-9 (2V)	46	66	74	79	81	78	71	60
40-12 (2V)	8	29	36	41	44	40	33	22	100-4-15	59	79	87	92	94	91	84	73
45-2-2	47	68	75	80	83	79	72	61	100-8-15 (2V)	44	64	72	77	79	76	69	58
45-4-2 (2V)	32	53	60	65	68	64	57	46	100-4-20	61	81	89	94	96	93	86	75
45-2-3	49	70	77	82	85	81	74	63	100-8-20 (2V)	45	65	73	78	80	77	70	59
45-4-3 (2V)	34	55	62	67	70	66	59	48	100-6-3	60	71	79	84	86	83	76	65
45-4-0,75	37	58	65	70	73	69	62	51	100-12-3 (2V)	45	54	62	67	69	66	59	48
45-6	25	46	53	58	61	57	50	39	100-6-4	61	69	77	82	84	81	74	63
45-12 (2V)	10	31	38	43	46	42	35	24	100-12-4 (2V)	46	53	61	66	68	65	58	47
50-2-4	54	74	82	87	89	86	79	68	100-6-5,5	62	71	79	84	86	83	76	65
50-4-4 (2V)	39	59	67	72	74	71	64	53	100-12-5,5 (2V)	47	54	62	67	69	66	59	48
50-2-6	55	75	83	88	90	87	80	69	100-8-2	55	65	73	78	80	77	70	59
50-4-6 (2V)	40	60	68	73	75	72	65	54	100-8-3	55	67	75	80	82	79	72	61
50-4-1	41	61	69	74	76	73	66	55	100-8-4	56	67	75	80	82	79	72	61
50-6	30	50	58	63	65	62	55	44	125-4/3-10	67	73	85	95	95	91	83	79
50-12 (2V)	15	35	43	48	50	47	40	29	125-4/3-9	67	73	85	95	95	91	83	79
56-2-6	60	80	88	93	95	92	85	74	125-8/3-9 (2V)	47	53	65	75	75	71	63	59
56-4-6 (2V)	44	64	72	77	79	76	69	58	125-4/3-15	68	74	86	96	96	92	84	80
56-2-12	61	81	89	94	96	93	86	75	125-8/3-15 (2V)	48	54	66	76	76	72	64	60
56-4-12 (2V)	46	66	74	79	81	78	71	60	125-4/3-20	70	76	88	98	98	94	86	82
56-4-1	45	65	73	78	80	77	70	59	125-8/3-20 (2V)	50	56	68	78	78	74	66	62
56-4-1,5	46	66	74	79	81	78	71	60	125-4/3-25	70	76	88	98	98	94	86	82
56-8-1,5 (2V)	31	51	59	64	66	63	56	45	125-4/3-30	71	77	89	99	99	95	87	83
56-4-2	47	67	75	80	82	79	72	61	125-4/3-27	71	77	89	99	99	95	87	83
56-8-2 (2V)	32	52	60	65	67	64	57	46	125-8/3-27 (2V)	50	56	68	78	78	74	66	62
56-6	35	55	63	68	70	67	60	49	125-4/3-37	72	78	90	100	100	96	88	84
56-12 (2V)	20	40	48	53	55	52	45	34	125-8/3-37 (2V)	51	57	69	79	79	75	67	63
63-4-1	47	67	75	80	82	79	72	61	125-4/3-40	72	78	90	100	100	96	88	84
63-4-1,5	46	66	74	79	81	78	71	62	125-8/3-40 (2V)	51	57	69	79	79	75	67	63
63-8-1,5 (2V)	31	51	59	64	66	63	56	47	125-4/6-20	64	72	88	95	97	92	86	82
63-4-2	49	66	74	79	81	78	71	63	125-8/6-20 (2V)	43	51	67	74	76	71	65	61
63-8-2 (2V)	34	51	59	64	66	63	56	48	125-4/6-22	64	72	88	95	97	92	86	82
63-4-3	50	68	76	81	83	80	75	64	125-8/6-22 (2V)	44	52	68	75	77	72	66	62
63-8-3 (2V)	35	53	61	66	68	65	60	49	125-4/6-25	65	73	89	96	98	93	87	83
63-4-4	51	69	77	82	84	81	76	65	125-4/6-27	65	73	89	96	98	93	87	83
63-8-4 (2V)	36	54	62	67	69	66	61	50	125-8/6-27 (2V)	44	52	68	75	77	72	66	62
63-6-0,75	40	58	66	71	73	70	63	54	125-4/6-30	65	73	89	96	98	93	87	83
63-12-0,75 (2V)	25	41	49	54	56	53	46	35	125-4/6-37	65	73	89	96	98	93	87	83
63-6-1	41	60	68	73	75	72	65	55	125-8/6-37 (2V)	45	53	69	76	78	73	67	63
63-12-1 (2V)	26	43	51	56	58	55	48	40	125-4/6-40	67	75	91	98	100	95	89	85
71-4-1,5	52	72	80	85	87	84	77	66	125-8/6-40 (2V)	46	54	70	77	79	74	68	64
71-8-1,5 (2V)	37	56	64	69	71	68	62	51	125-4/6-50	68	76	92	99	101	96	90	86
71-4-2	51	71	79	84	86	83	76	67	125-4/9-25	63	71	88	94	95	90	85	81
71-8-2 (2V)	36	56	64	69	71	68	61	52	125-4/9-22	63	71	88	94	95	90	85	81
71-4-3	55	70	78	83	85	82	75	69	125-8/9-22 (2V)	44	52	69	75	76	71	66	62
71-8-3 (2V)	40	55	63	68	70	67	60	54	125-4/9-30	64	72	89	95	96	91	86	82
71-4-4	56	71	79	84	86	83	76	70	125-4/9-27	64	72	89	95	96	91	86	82
71-8-4 (2V)	41	56	64	69	71	68	61	55	125-8/9-27 (2V)	45	53	70	76	77	72	67	63
71-6-0,75	42	62	70	73	75	72	65	54	125-4/9-37	65	73	90	96	97	92	87	83
71-12-0,75 (2V)	27	43	51	56	58	55	48	37	125-8/9-37 (2V)	45	53	70	76	77	72	67	63
71-6-1	43	63	71	73	75	72	65	54	125-4/9-40	66	74	91	97	98	93	88	84
71-12-1 (2V)	28	44	52	57	59	56	49	38	125-8/9-40 (2V)	46	54	71	77	78	73	68	64
71-6-1,5	44	64	69	74	76	73	66	55	125-4/9-50	68	76	93	99	100	95	90	86
71-12-1,5 (2V)	29	44	52	57	59	56	49	38	125-6/3-4	63	71	83	87	85	80	71	67
80-4-3	56	75	83	89	90	87	81	70	125-12/3-4 (2V)	48	56	68	72	70	65	56	52
80-8-3 (2V)	41	60	68	74	75	72	66	55	125-6/3-5,5	64	72	84	88	86	81	72	68
80-4-4	54	74	82	87	89	86	79	71	125-12/3-5,5 (2V)	49	57	69	73	71	66	57	53
80-8-4 (2V)	39	59	67	72	74	71	64	56	125-6/3-7,5	65	73	85	89	87	82	73	69
80-4-5,5	54	74	82	87	89	86	79	72	125-12/3-7,5 (2V)	50	58	70	74	72	67	58	54
80-8-5,5 (2V)	38	58	66	71	73	70	63	57	125-6/3-10	67	75	87	91	89	84	75	71
80-6-1,5	47	64	72	77	79	76	69	58	125-12/3-10 (2V)	52	60	72	76	74	69	60	56
80-12-1,5 (2V)	32	47	55	60	62	59	52	41	125-6/3-15	68	76	88	92	90	85	76	72
80-6-2	48	65	73	78	80	77	70	59	125-12/3-15 (2V)	53	61	73	77	75	70	61	57
80-12-2 (2V)	33	48	56	61	63	60	53	42	125-6/3-20	69	77	89	93	91	86	77	73
80-6-3	49	66	74	79	81	78	71	60	125-6/3-24	69	77	89	93	91	86	77	73
80-12-3 (2V)	34	49	57	62	64	61	54	43	125-12/3-24 (2V)	54	62	74	78	76	71	62	58
80-8-0,75	45	58	66	71	73	70	63	52	125-6/6-5,5	58	67	80	83	84	81	70	66
80-8-1	46	59	67	72	74	71	64	53	125-12/6-5,5 (2V)	43	52	65	68	69	66	55	51
90-4-4	59	80	87	92	95	91	84	76	125-6/6-7,5	58	67	80	83	84	81	70	66
90-8-4 (2V)	44	65	72	77	80	76	69	61	125-12/6-7,5 (2V)	43	52	65	68	69	66	55	51
90-4-5,5	58	79	86	91	94	90	83	72	125-6/6-10	60	69	82	85	86	83	72	68
90-8-5,5 (2V)	43	64	71	76	79	75	68	57	125-12/6-10 (2V)	45	54	67	70	71	68	57	53
90-4-7,5	57	78	85	90	93	89	82	71	125-6/6-15	62	71	84	87	88	85	74	70
90-8-7,5 (2V)	41	62	69	74	77	73	66	55	125-12/6-15 (2V)	47	56	69	72	73	70	59	55
90-4-10	56	77	84	89	92	88	81	70	125-6/6-20	63	72	85	88	89	86	75	71
90-4-9	56	77	84	89	92	88	81	70	125-6/6-24	63	72	85	88	89	86	75	71
90-8-9 (2V)	41	62	69	74	77	73	66	55	125-12/6-24 (2V)	48	57	70	73	74			

### Dimensions in mm

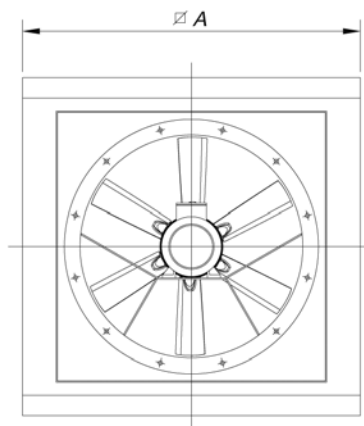
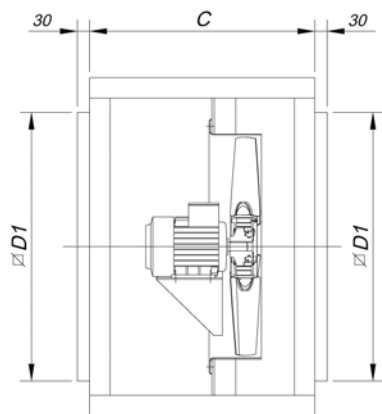

Model	ØA	C	ØD1
CJTHT-40/45/50	700	550	565
CJTHT-56/63	825	550	690
CJTHT-71/80	1000	650	850
CJTHT-90/100	1200	750	1050
CJTHT-125	1600	1200	1400

### Characteristic curves

See characteristic curves on THT serie

### Accessories

See accessories section



INT

IAT

CABLE BOX

C2V

AET

CENTRAL CO

VSD

P-400

# THT/IMP

400 °C/2h and 300 °C/2h long range one-way or reversible jet fans



THT/IMP-C

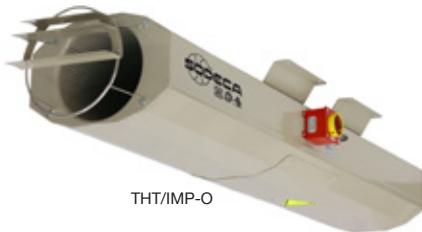

THT/IMP-O

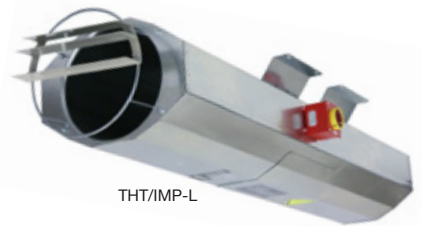

THT/IMP-L

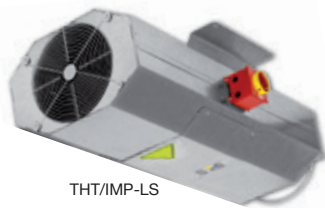

THT/IMP-LS

300 °C/2h and 400 °C/2h long range one-way or reversible jet fans with a circular (THT/IMP-C), octagonal (THT/IMP-L) or octagonal painted (THT/IMP-O) design

Fan:

- One-way or reversible fan unit including fan, silencers, deflectors and support, approved for smoke extraction in accordance with standard EN 12101-3, with certification no.: 0370-CPR-0394
- Adjustable rotors made of cast aluminium and designed to produce great thrusts.
- Anti-contact protective grille pursuant to standard UNE-EN ISO 12499.
- Deflector to increase the air range on the impulsion side. Reversible models are fitted with deflectors on both sides.
- High attenuation silencers with thermal and acoustic insulation.
- IAT series safety switch built into the fan (THT/IMP-L and THT/IMP-O) or on request (THT/IMP-C).
- Air direction from Motor to Impeller or 100 % reversible.
- THT/IMP-C: Circular casing in painted sheet steel.
- THT/IMP-L: Galvanised sheet steel casing.
- THT/IMP-O: Painted steel casing.
- THT/IMP-LS: Short length galvanised sheet steel casing.

Motor:

- Class H motors, S1 continuous operation and S2 emergency use, with ball bearings, IP55 protection and 2 speeds.
- Multi voltage motor, special design valid for 220/380V 60Hz, 254/440V 60Hz, 265/460V 60Hz, 277/480V 60Hz.
- Maximum temperature of air to be carried: S1 continuous operation -20 °C +40 °C, S2 operation 300 °C/2h and 400 °C/2h.

Finish:

- Anti-corrosive finish of polyester resin polymerised at 190 °C, previously degreased with phosphate-free nanotechnological treatment (THT/IMP-C, THT/IMP-O) or with a galvanised sheet steel anticorrosive finish (THT/IMP-L).

On request:

- Thrust features different from those indicated.
- Version for outdoor operation in the fire risk zone (see HCT/IMP series).



Deflector for increasing range

Order code

**THT/IMP — O — UNI — 38 — 2/4T — — 1.5 — F-400 — 60Hz**

<p>THT/IMP: Large range jet fans</p> <p>Design C: Circular casing O: Painted casing L: Galvanised sheet steel casing. LS: Small-sized casing</p>	<p>Airflow direction UNI: One-way REV: Reversible</p>	<p>Rotor diameter in cm</p>	<p>Number of motor poles 2=3500 r/min. 60 Hz 4=1680 r/min. 60 Hz 6=1080 r/min. 60 Hz 8=900 r/min. 60 Hz 12=750 r/min. 60 Hz</p>	<p>T= Three-phase</p>	<p>Motor power (hp)</p>	<p>F-300: Approval. Tested for 300 °C/2h. F-400: 400 °C/2h approved</p>
--	---	-----------------------------	---	-----------------------	-------------------------	---

### Technical characteristics

Model	Speed (r/min)	Maximum current 380-480V (A)	Flow rate (m <sup>3</sup> /h)	Thrust (N)	Speed impulsion (m/s)	Installed power (kW)	Sound pressure LpA at 10m dB(A)	Approx. weight (kg)
<b>One-way</b>								
THT/IMP-C-UNI-31-2/4T	3432 / 1716	1.50 / 0.55	4260 / 2130	21 / 5	15.6 / 7.8	0.55 / 0.15	51 / 36	65
THT/IMP-C-UNI-35-2/4T	3450 / 1716	2.10 / 0.80	6360 / 3180	36 / 9	17.8 / 8.9	0.85 / 0.20	52 / 37	70
THT/IMP-C-UNI-38-2/4T-1.5	3480 / 1740	2.90 / 1.10	8450 / 4225	57 / 15	20.7 / 10.3	1.10 / 0.25	47 / 32	89
THT/IMP-C-UNI-40-2/4T-1.5	3480 / 1740	2.90 / 1.10	9250 / 4625	60 / 15	20.4 / 10.2	1.10 / 0.25	53 / 38	98
THT/IMP-C-UNI-45-2/4T-2	3528 / 1752	4.40 / 1.40	10800 / 5400	62 / 15	18.1 / 9.0	1.50 / 0.37	57 / 42	132
THT/IMP-C-UNI-45-2/4T-3	3516 / 1740	5.70 / 1.80	13200 / 6600	92 / 23	22.1 / 11.0	2.20 / 0.60	58 / 43	133
THT/IMP-C-UNI-50-2/4T-6	3516 / 1740	10.00 / 3.20	19700 / 9850	165 / 41	26.4 / 13.2	4.50 / 1.30	60 / 45	220
THT/IMP-O-UNI-29-2/4T	3432 / 1716	1.50 / 0.55	4000 / 2000	21 / 5	16.8 / 8.4	0.55 / 0.15	37 / 22	69
THT/IMP-O-UNI-35-2/4T	3450 / 1716	2.10 / 0.80	6360 / 3180	36 / 9	17.8 / 8.9	0.85 / 0.20	52 / 37	70
THT/IMP-O-UNI-38-2/4T-1.5	3480 / 1740	2.90 / 1.10	8450 / 4225	57 / 15	20.7 / 10.3	1.10 / 0.25	47 / 32	94
THT/IMP-O-UNI-40-2/4T-1.5	3480 / 1740	2.90 / 1.10	9250 / 4625	60 / 15	20.4 / 10.2	1.10 / 0.25	53 / 38	104
THT/IMP-O-UNI-45-2/4T-2	3528 / 1752	4.40 / 1.40	10800 / 5400	62 / 15	18.1 / 9.0	1.50 / 0.37	57 / 42	140
THT/IMP-O-UNI-45-2/4T-3	3516 / 1740	5.70 / 1.80	13200 / 6600	92 / 23	22.1 / 11.0	2.20 / 0.60	58 / 43	141
THT/IMP-O-UNI-50-2/4T-6	3516 / 1740	10.00 / 3.20	19700 / 9850	165 / 41	26.4 / 13.2	4.50 / 1.30	60 / 45	234
THT/IMP-L-UNI-29-2/4T	3432 / 1716	1.50 / 0.55	4000 / 2000	21 / 5	16.8 / 8.4	0.55 / 0.15	37 / 22	69
THT/IMP-L-UNI-35-2/4T	3450 / 1716	2.10 / 0.80	6360 / 3180	36 / 9	17.8 / 8.9	0.85 / 0.20	52 / 37	70
THT/IMP-L-UNI-38-2/4T-1.5	3480 / 1740	2.90 / 1.10	8450 / 4225	57 / 15	20.7 / 10.3	1.10 / 0.25	47 / 32	94
THT/IMP-L-UNI-40-2/4T-1.5	3480 / 1740	2.90 / 1.10	9250 / 4625	60 / 15	20.4 / 10.2	1.10 / 0.25	53 / 38	104
THT/IMP-L-UNI-45-2/4T-2	3528 / 1752	4.40 / 1.40	10800 / 5400	62 / 15	18.1 / 9.0	1.50 / 0.37	57 / 42	140
THT/IMP-L-UNI-45-2/4T-3	3516 / 1740	5.70 / 1.80	13200 / 6600	92 / 23	22.1 / 11.0	2.20 / 0.60	58 / 43	141
THT/IMP-L-UNI-50-2/4T-6	3516 / 1740	10.00 / 3.20	19700 / 9850	165 / 41	26.4 / 13.2	4.50 / 1.30	60 / 45	234
THT/IMP-LS-UNI-29-2/4T	3432 / 1716	1.50 / 0.55	4000 / 2000	21 / 5	16.8 / 8.4	0.55 / 0.15	39 / 24	55
THT/IMP-LS-UNI-35-2/4T	3450 / 1716	2.10 / 0.80	6360 / 3180	36 / 9	17.8 / 8.9	0.85 / 0.20	54 / 39	56
THT/IMP-LS-UNI-38-2/4T-1.5	3480 / 1740	2.90 / 1.10	8450 / 4225	57 / 15	20.7 / 10.3	1.10 / 0.25	49 / 34	76
THT/IMP-LS-UNI-40-2/4T-1.5	3480 / 1740	2.90 / 1.10	9250 / 4625	60 / 15	20.4 / 10.2	1.10 / 0.25	55 / 40	83
THT/IMP-LS-UNI-45-2/4T-2	3528 / 1752	4.40 / 1.40	10800 / 5400	62 / 15	18.1 / 9.0	1.50 / 0.37	59 / 44	112
THT/IMP-LS-UNI-45-2/4T-3	3516 / 1740	5.70 / 1.80	13200 / 6600	92 / 23	22.1 / 11.0	2.20 / 0.60	60 / 45	113
THT/IMP-LS-UNI-50-2/4T-6	3516 / 1740	10.00 / 3.20	19700 / 9850	165 / 41	26.4 / 13.2	4.50 / 1.30	62 / 47	187

### Reversible

THT/IMP-C-REV-31-2/4T	3432 / 1716	1.50 / 0.55	3840 / 1920	17 / 4	14.1 / 7.0	0.55 / 0.15	50 / 35	63
THT/IMP-C-REV-35-2/4T	3450 / 1716	2.10 / 0.80	5940 / 2970	31 / 8	16.7 / 8.3	0.85 / 0.20	51 / 36	70
THT/IMP-C-REV-38-2/4T-2	3528 / 1752	4.40 / 1.40	8200 / 4100	54 / 14	20.1 / 10.0	1.50 / 0.37	49 / 34	91
THT/IMP-C-REV-40-2/4T-2	3528 / 1752	4.40 / 1.40	9250 / 4625	60 / 15	20.4 / 10.2	1.50 / 0.37	52 / 37	100
THT/IMP-C-REV-45-2/4T-2	3528 / 1752	4.40 / 1.40	10300 / 5150	56 / 14	17.2 / 8.6	1.50 / 0.37	56 / 41	131
THT/IMP-C-REV-45-2/4T-3	3516 / 1740	5.70 / 1.80	12800 / 6400	87 / 22	21.4 / 10.7	2.20 / 0.60	57 / 42	133
THT/IMP-C-REV-50-2/4T-6	3516 / 1740	10.00 / 3.20	19000 / 9500	153 / 38	25.4 / 12.7	4.50 / 1.30	60 / 45	267
THT/IMP-O-REV-29-2/4T	3432 / 1716	1.50 / 0.55	3400 / 1700	15 / 4	14.3 / 7.1	0.55 / 0.15	38 / 23	67
THT/IMP-O-REV-35-2/4T	3450 / 1716	2.10 / 0.80	5940 / 2970	31 / 8	16.7 / 8.3	0.85 / 0.20	51 / 36	70
THT/IMP-O-REV-38-2/4T-2	3528 / 1752	4.40 / 1.40	8200 / 4100	54 / 14	20.1 / 10.0	1.50 / 0.37	49 / 34	97
THT/IMP-O-REV-40-2/4T-2	3528 / 1752	4.40 / 1.40	9250 / 4625	60 / 15	20.4 / 10.2	1.50 / 0.37	52 / 37	106
THT/IMP-O-REV-45-2/4T-2	3528 / 1752	4.40 / 1.40	10300 / 5150	56 / 14	17.2 / 8.6	1.50 / 0.37	56 / 41	139
THT/IMP-O-REV-45-2/4T-3	3516 / 1740	5.70 / 1.80	12800 / 6400	87 / 22	21.4 / 10.7	2.20 / 0.60	57 / 42	141
THT/IMP-O-REV-50-2/4T-6	3516 / 1740	10.00 / 3.20	19000 / 9500	153 / 38	25.4 / 12.7	4.50 / 1.30	60 / 45	284
THT/IMP-L-REV-29-2/4T	3432 / 1716	1.50 / 0.55	3400 / 1700	15 / 4	14.3 / 7.1	0.55 / 0.15	38 / 23	67
THT/IMP-L-REV-35-2/4T	3450 / 1716	2.10 / 0.80	5940 / 2970	31 / 8	16.7 / 8.3	0.85 / 0.20	51 / 36	70
THT/IMP-L-REV-38-2/4T-2	3528 / 1752	4.40 / 1.40	8200 / 4100	54 / 14	20.1 / 10.0	1.50 / 0.37	49 / 34	97
THT/IMP-L-REV-40-2/4T-2	3528 / 1752	4.40 / 1.40	9250 / 4625	60 / 15	20.4 / 10.2	1.50 / 0.37	52 / 37	106
THT/IMP-L-REV-45-2/4T-2	3528 / 1752	4.40 / 1.40	10300 / 5150	56 / 14	17.2 / 8.6	1.50 / 0.37	56 / 41	139
THT/IMP-L-REV-45-2/4T-3	3516 / 1740	5.70 / 1.80	12800 / 6400	87 / 22	21.4 / 10.7	2.20 / 0.60	57 / 42	141
THT/IMP-L-REV-50-2/4T-6	3516 / 1740	10.00 / 3.20	19000 / 9500	153 / 38	25.4 / 12.7	4.50 / 1.30	60 / 45	284
THT/IMP-LS-REV-29-2/4T	3432 / 1716	1.50 / 0.55	3400 / 1700	15 / 4	14.3 / 7.1	0.55 / 0.15	40 / 25	55
THT/IMP-LS-REV-35-2/4T	3450 / 1716	2.10 / 0.80	5940 / 2970	31 / 8	16.7 / 8.3	0.85 / 0.20	53 / 38	56
THT/IMP-LS-REV-38-2/4T-2	3528 / 1752	4.40 / 1.40	8200 / 4100	54 / 14	20.1 / 10.0	1.50 / 0.37	51 / 36	77
THT/IMP-LS-REV-40-2/4T-2	3528 / 1752	4.40 / 1.40	9250 / 4625	60 / 15	20.4 / 10.2	1.50 / 0.37	53 / 39	85
THT/IMP-LS-REV-45-2/4T-2	3528 / 1752	4.40 / 1.40	10300 / 5150	56 / 14	17.2 / 8.6	1.50 / 0.37	58 / 43	111
THT/IMP-LS-REV-45-2/4T-3	3516 / 1740	5.70 / 1.80	12800 / 6400	87 / 22	21.4 / 10.7	2.20 / 0.60	59 / 44	113
THT/IMP-LS-REV-50-2/4T-6	3516 / 1740	10.00 / 3.20	19000 / 9500	153 / 38	25.4 / 12.7	4.50 / 1.30	62 / 47	227

Dimensions mm

C: Circular casing

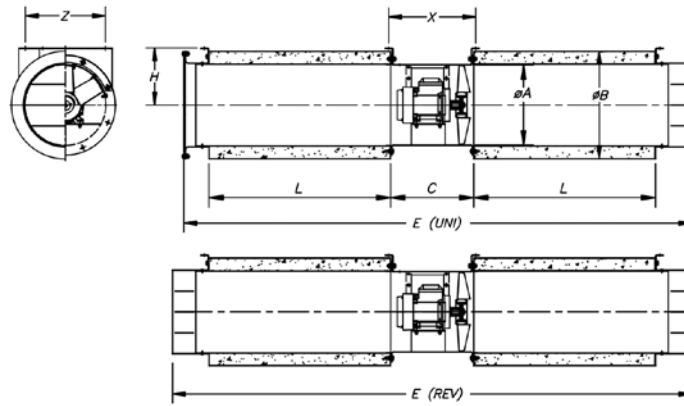

Model	$\varnothing A$	$\varnothing B$	C	L	$\varnothing d$	E (UNI)	E (REV)	H	X	Z
THT/IMP-C-31	315	415	320	700	10	1956	2000	220	345	275
THT/IMP-C-35	355	460	325	700	12	1960	2005	250	346	300
THT/IMP-C-38	380	415	340	1000	12	2570	2620	225	530	517
THT/IMP-C-40	410	510	340	950	12	2485	2540	280	376	340
THT/IMP-C-45	460	630	360	950	12	2500	2554	355	396	440

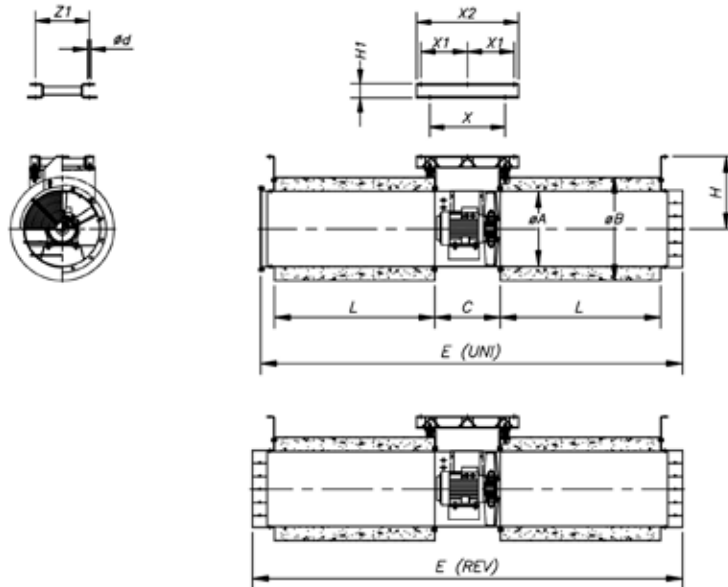

Model	$\varnothing A$	$\varnothing B$	C	L	$\varnothing d$	E (UNI)	E (REV)	H	H1-	X	X1	X2	Z	Z1
THT/IMP-C-50	514	710	450	1100	12	2895	2950	498	80	518	320	700	380	370

O: Painted casing  
 L: Galvanised sheet steel casing.  
 LS: Small-sized casing

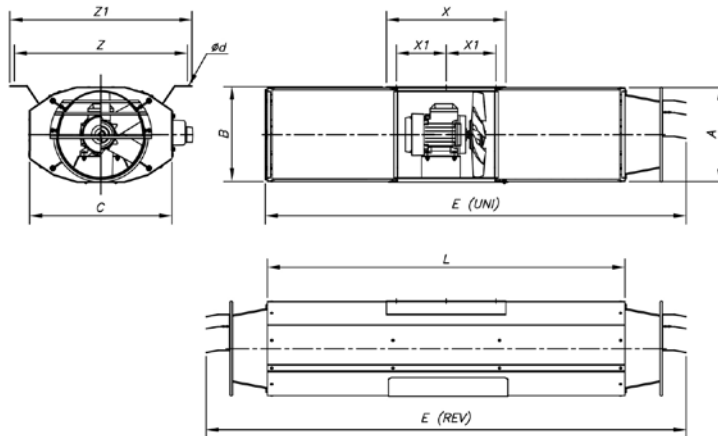

	A	B	C	ød	E (UNI)	E (REV)	L	X	X1	Z	Z1
THT/IMP-LS-29	319.5	324	479	12x26	1410	1610	1200	400	167	580	610
THT/IMP-L-29	319.5	324	479	12x26	2210	2410	2000	400	167	580	610
THT/IMP-O-29	319.5	324	479	12x26	2210	2410	2000	400	167	580	610
THT/IMP-LS-35	383	386	523	12x26	1410	1610	1200	400	167	614	644
THT/IMP-L-35	383	386	523	12x26	2210	2410	2000	400	167	614	644
THT/IMP-O-35	383	386	523	12x26	2210	2410	2000	400	167	614	644
THT/IMP-LS-38	406	409	550	12x26	1410	1610	1200	400	170	640	670
THT/IMP-L-38	406	409	550	12x26	2210	2410	2000	400	170	640	670
THT/IMP-O-38	406	409	550	12x26	2210	2410	2000	400	170	640	670
THT/IMP-LS-40	436	439	582	12x26	1410	1610	1200	400	170	670	700
THT/IMP-L-40	436	439	582	12x26	2210	2410	2000	400	170	670	700
THT/IMP-O-40	436	439	582	12x26	2210	2410	2000	400	170	670	700
THT/IMP-LS-45	486	489	630	12x26	1410	1610	1200	400	170	724	754
THT/IMP-L-45	486	489	630	12x26	2210	2410	2000	400	170	724	754
THT/IMP-O-45	486	489	630	12x26	2210	2410	2000	400	170	724	754
THT/IMP-LS-50	546	549	742	12x26	1445	1675	1200	580	255	778	808
THT/IMP-L-50	546	549	742	12x26	2245	2475	2000	580	255	778	808
THT/IMP-O-50	546	549	742	12x26	2245	2475	2000	580	255	778	808

For use in garages

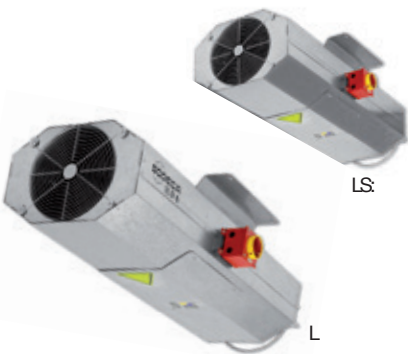

Installation of jet fans for immersed operation in fire risk zones

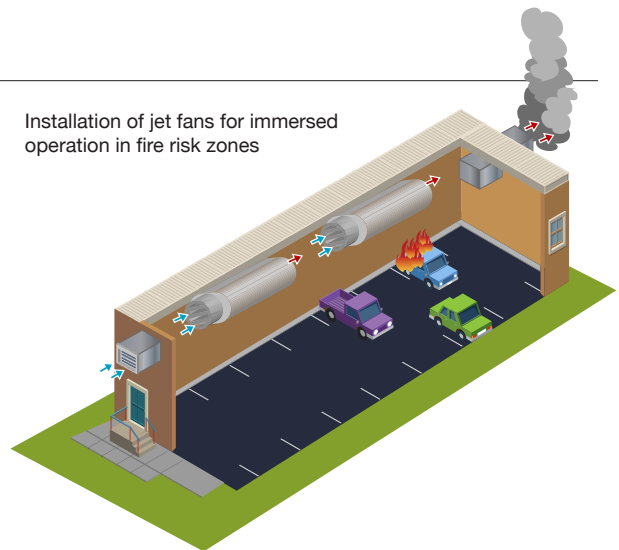

Accessories



# CI

## Long-range 300 °C/2h and 400 °C/2h centrifugal induction jet fans for use in fire risk zones with a low profile.



External junction box.  
Support feet

Long-range 300 °C/2h and 400 °C/2h centrifugal induction jet fans for use in fire risk zones with a low profile.

**Fan:**

- Sheet steel casing.
- Impeller with reaction blades in extremely robust sheet steel.
- External junction box.
- Support feet included.

**Motor:**

- Class H motors, S1 continuous operation and S2 emergency use, with ball bearings, IP55 protection and with 1 or 2 speeds, depending on model.
- Multi voltage motor, special design valid for 220/380V 60Hz, 254/440V 60Hz, 265/460V 60Hz, 277/480V 60Hz
- Maximum temperature of air to be carried: S1 continuous operation -20 °C +40 °C, S2 operation 300 °C/2h and 400 °C/2h.

**Finish:**

- Anti-corrosive finish of polyester resin polymerised at 190 °C, previously degreased with phosphate-free nanotechnological treatment.

**On request:**

- Version for outdoor operation in the fire risk zone (see CI-CO series)

### Order code

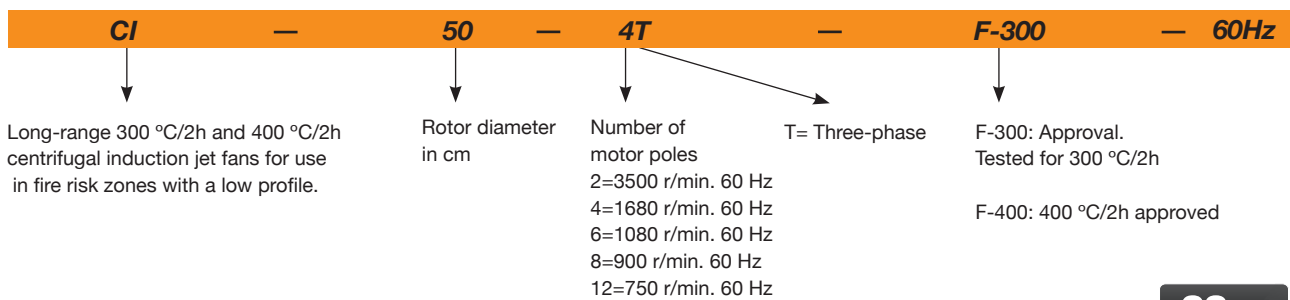

### Technical characteristics



Model	Speed (r/min)	Maximum admissible current (A)		Flow rate (m³/h)	Thrust (N)	Installed power (kW)	Sound pressure at 1m dB(A)	Approx. weight (kg)
		220-277V	380-480V					
CI-50-4T	1674	5.00	2.90	6050	50	1.20	78	83
CI-50-4/8T	1674/780		2.90 / 1.20	6050 / 3020	50 / 13	1.20 / 0.30	78/63	83
CI-75-4T	1740	9.00	5.20	8080	75	2.20	85	139
CI-75-4/8T	1740/876		5.20 / 2.05	8080 / 4040	75 / 19	2.20 / 0.37	85/70	139
CI-100-4T	1734	9.90	5.70	9340	100	2.40	89	141
CI-100-4/8T	1734/858		5.70 / 2.20	9340 / 4670	100 / 25	2.40 / 0.55	89/14	141

### Dimensions mm

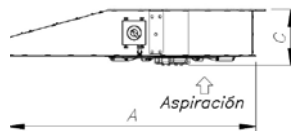
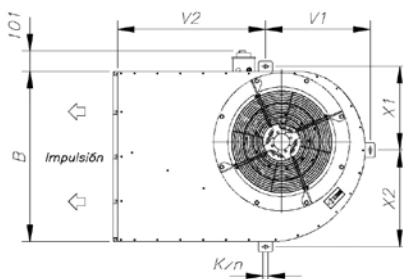

Model	A	B	C	V2	V1	X1	X2	Kxn
CI-50-F300	1240	840	272.5	741.5	524.5	413	477	12x26
CI-50-F400	1240	840	261.5	741.5	524.5	413	477	12x26
CI-75-F300	1778	1040	311	1143	662	494	596	12x26
CI-75-F400	1778	1040	299	1143	662	494	596	12x26
CI-100 F-300	1778	1040	323	1143	662	494	596	12x26
CI-100 F-400	1778	1040	323	1143	662	494	596	12x26

### Accessories



# HTMF

## 400 °C/2h (F-400) and 300 °C/2h (F-300) rated roof-mounted multifunctional extractor fans

400 °C/2h rated roof-mounted multifunctional extractor fans for work in fire risk zones, designed for smoke extraction in industrial or similar buildings

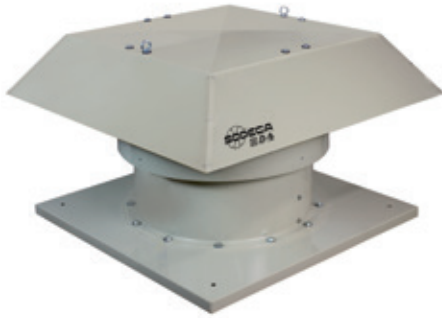

### Fan:

- Painted, galvanised sheet steel support base.
- Cast aluminium orientable rotors.
- Anti-contact protective grille pursuant to standard UNE-EN ISO 12499.
- Painted, galvanised sheet steel rain cap, with natural air outlet. Approved based on standard EN 12101-3, with certificate no. 0370-CPR-0544.

### Motor:

- Class H motors, S1 continuous operation and S2 emergency use, with ball bearings, IP55 protection and with 1 or 2 speeds, depending on model.
- Multi voltage motor, special design valid for 220/380V 60Hz, 254/440V 60Hz, 265/460V 60Hz, 277/480V 60Hz
- Maximum temperature of air to be carried: S1 continuous operation -20 °C +40 °C, S2 operation 300 °C/2h, 400 °C/2h.

### Finish:

- Anti-corrosive finish of polyester resin polymerised at 190 °C, previously degreased with phosphate-free nanotechnological treatment.

### Order code

<b>HTMF</b>	—	<b>56</b>	—	<b>4T</b>	—	<b>2</b>	—	<b>F-400</b>	—	<b>60Hz</b>
↓		↓		↓	↓	↓		↓		
HTMF: 400 °C/2h and 300 °C/2h roof-mounted multifunctional extractor fans		Rotor diameter in cm		Number of motor poles 2=3500 r/min. 60 Hz 4=1680 r/min. 60 Hz 6=1080 r/min. 60 Hz 8=900 r/min. 60 Hz 12=750 r/min. 60 Hz	T= Three-phase	Motor power (hp)		F-300: 300 °C/2h approved F-400: 400 °C/2h approved		

### Technical characteristics

60Hz

Model	Speed (r/min)	Maximum admissible current (A)		Installed power (kW)	Maximum flow rate (m³/h)	Sound pressure (1) level dB(A)		Approx. weight (kg)
		220-277V	380-480V			Intake	Discharge	
HTMF-56-4T-1	1716	3.80	2.20	0.75	10545	62	59	65
HTMF-56-4T-1.5	1704	4.70	2.70	1.10	11400	63	60	71
HTMF-56-4/8T-1.5	1728 / 852		2.90 / 1.40	1.10 / 0.25	11400 / 5700	63 / 48	60 / 45	75
HTMF-56-6T-0.75	1116	3.30	1.90	0.55	8170	51	49	64
HTMF-63-4T-1.5	1704	4.70	2.70	1.10	13870	65	62	83
HTMF-63-4/8T-1.5	1728 / 852		2.90 / 1.40	1.10 / 0.25	13870 / 6935	65 / 50	62 / 47	87
HTMF-63-4T-2	1710	6.60	3.80	1.50	15485	66	63	85
HTMF-63-4/8T-2	1698 / 858		3.60 / 1.50	1.50 / 0.30	15485 / 7742	66 / 51	63 / 48	90
HTMF-63-4T-3	1722	9.20	5.30	2.20	17955	67	64	90
HTMF-63-4/8T-3	1698 / 858		5.20 / 1.90	2.20 / 0.45	17955 / 8977	67 / 52	64 / 49	103
HTMF-63-6T-0.75	1116	3.30	1.90	0.55	10260	56	54	76
HTMF-63-6T-1	1128	4.40	2.60	0.75	11305	57	55	85
HTMF-71-4T-2	1710	6.60	3.80	1.50	16150	69	66	90
HTMF-71-4/8T-2	1698 / 858		3.60 / 1.50	1.50 / 0.30	16150 / 8075	69 / 54	66 / 51	96
HTMF-71-4T-3	1722	9.20	5.30	2.20	18430	71	68	96
HTMF-71-4/8T-3	1698 / 858		5.20 / 1.90	2.20 / 0.45	18430 / 9215	71 / 56	68 / 53	109
HTMF-71-4T-4	1716	11.40	6.60	3.00	22610	72	69	100
HTMF-71-4/8T-4	1704 / 846		6.90 / 2.30	3.00 / 0.60	22610 / 11305	72 / 57	69 / 54	111



**Technical characteristics**

Model	Speed (r/min)	Maximum admissible current (A)		Installed power (kW)	Maximum flow rate (m³/h)	Sound pressure (1) level dB(A)		Approx. weight (kg)
		220-277V	380-480V			Intake	Discharge	
HTMF-71-6T-1	1128	4.40	2.60	0.75	13205	58	56	90
HTMF-71-6T-1.5	1134	6.40	3.70	1.10	16245	59	57	92
HTMF-80-4T-4	1716	11.40	6.60	3.00	27600	73	70	123
HTMF-80-4/8T-4	1704 / 846		6.90 / 2.30	3.00 / 0.60	27600 / 13800	73 / 58	70 / 55	134
HTMF-80-4T-5.5	1728		8.40	4.00	30176	74	71	134
HTMF-80-4/8T-5,5	1740 / 864		9.40 / 3.50	4.00 / 0.80	30176 / 15088	74 / 59	71 / 56	138
HTMF-80-6T-1.5	1134	6.40	3.70	1.10	19412	62	60	115
HTMF-80-6T-2	1134	7.40	4.30	1.50	22172	63	61	120
HTMF-80-6T-3	1140	10.30	5.90	2.20	24932	64	62	134
HTMF-80-8T-1	852	4.80	2.80	0.75	16376	61	60	132
HTMF-90-4T-5.5	1728		8.40	4.00	35052	79	76	156
HTMF-90-4/8T-5,5	1740 / 864		9.40 / 3.50	4.00 / 0.80	35052 / 17526	79 / 64	76 / 61	160
HTMF-90-4T-7.5	1716		11.50	5.50	38456	81	78	161
HTMF-90-4/8T-7,5	1746 / 870		12.80 / 4.60	5.50 / 1.10	38456 / 19228	81 / 66	78 / 63	207
HTMF-90-4T-10	1752		17.70	7.50	41308	82	79	225
HTMF-90-4/8T-9	1746 / 870		15.50 / 5.50	6.70 / 1.50	41308 / 20654	82 / 67	79 / 64	215
HTMF-90-6T-3	1140	10.30	5.90	2.20	29256	68	66	156
HTMF-90-6/12T-3	1128 / 564		5.60 / 2.20	2.20 / 0.37	29256 / 14628	68 / 53	66 / 51	161
HTMF-90-6T-4	1134	15.00	8.70	3.00	32016	69	67	164
HTMF-90-6/12T-4	1164 / 570		8.90 / 3.50	3.00 / 0.55	32016 / 16008	69 / 54	67 / 52	188
HTMF-90-8T-1	852	4.80	2.80	0.75	17020	61	60	154
HTMF-90-8T-2	840	9.00	5.20	1.50	19596	63	62	158
HTMF-100-4T-7.5	1716		11.50	5.50	40756	84	81	185
HTMF-100-4/8T-7,5	1746 / 870		12.80 / 4.60	5.50 / 1.10	40756 / 20378	84 / 69	81 / 66	231
HTMF-100-4T-10	1752		17.70	7.50	47564	85	82	249
HTMF-100-4/8T-9	1746 / 870		15.50 / 5.50	6.70 / 1.50	44528 / 22264	84 / 69	81 / 66	239
HTMF-100-4T-15	1746		23.00	11.00	51336	86	83	268
HTMF-100-4/8T-14	1764 / 870		23.20 / 8.70	11.00 / 2.80	48300 / 24150	85 / 70	82 / 67	280
HTMF-100-6T-3	1140	10.30	5.90	2.20	32476	74	72	180
HTMF-100-6/12T-3	1128 / 564		5.60 / 2.20	2.20 / 0.37	32476 / 16238	74 / 59	72 / 57	185
HTMF-100-6T-4	1134	15.00	8.70	3.00	35420	75	73	188
HTMF-100-6/12T-4	1164 / 570		8.90 / 3.50	3.00 / 0.55	35420 / 17710	75 / 60	73 / 58	212
HTMF-100-6T-5.5	1164		11.00	4.00	40020	76	74	212
HTMF-100-6/12T-5.5	1164 / 576		11.30 / 4.20	4.00 / 0.65	40020 / 20010	76 / 61	74 / 59	239
HTMF-100-8T-3	846	13.20	7.60	2.20	26404	69	68	189
HTMF-100-8T-4	852	15.60	9.00	3.00	28704	70	69	249
HTMF-THT-125-4T/3/-10	1752		13.90	7.50	55250	75	72	333
HTMF-THT-125-4T/3/-15	1764		20.90	11.00	72150	76	73	372
HTMF-THT-125-4T/3/-20	1758		27.90	15.00	83120	78	75	394
HTMF-THT-125-4T/6/-15	1764		20.90	11.00	66800	76	73	388
HTMF-THT-125-4T/6/-20	1758		27.90	15.00	72900	76	73	410
HTMF-THT-125-4T/9/-20	1758		27.90	15.00	76310	75	72	425
HTMF-THT-125-6T/6/-5.5	1164		11.00	4.00	47760	63	61	347
HTMF-THT-125-6T/6/-7.5	1164		14.00	5.50	55600	63	61	384
HTMF-THT-125-6T/6/-10	1170		14.80	7.50	66170	65	63	393
HTMF-THT-125-6T/6/-15	1170		21.90	11.00	76380	67	65	415
HTMF-THT-125-6T/9/-7.5	1164		14.00	5.50	50000	64	62	399
HTMF-THT-125-6T/9/-10	1170		14.80	7.50	59340	64	62	408
HTMF-THT-125-6T/9/-15	1170		21.90	11.00	71890	67	65	430
HTMF-THT-125-6T/9/-20	1170		28.20	15.00	83660	70	68	475
HTMF-THT-125-8T/6/-4	852	15.60	9.00	3.00	47510	56	55	384
HTMF-THT-125-8T/6/-5.5	852		13.00	4.00	52770	58	57	404
HTMF-THT-125-8T/6/-7.5	852		15.10	5.50	60410	60	59	416
HTMF-THT-125-8T/6/-10	858		20.60	7.50	66030	61	60	424
HTMF-THT-125-8T/9/-5.5	852		13.00	4.00	51330	58	57	419
HTMF-THT-125-8T/9/-7.5	852		15.10	5.50	54480	61	60	431
HTMF-THT-125-8T/9/-10	858		20.60	7.50	65660	63	62	439
HTMF-THT-125-8T/9/-15	870		21.70	11.00	73870	64	63	445

(1) The noise level values are pressures in dB(A) measured at a distance of 6 metres in a free field.

### Acoustic characteristics

Values taken during intake with maximum flow rate

Values taken during discharge with maximum flow rate

Sound power spectrum Lw(A) in dB(A) per Hz frequency band.

Model	63	125	250	500	1000	2000	4000	8000	Model	63	125	250	500	1000	2000	4000	8000
56-4-1	46	67	74	79	82	78	71	60	56-4-1	43	64	71	76	79	75	68	57
56-4-1.5	47	68	75	80	83	79	72	61	56-4-1.5	44	65	72	77	80	76	69	58
56-6-0.75	35	56	63	68	71	67	60	49	56-6-0.75	33	54	61	66	69	65	58	47
56-8-1.5	32	53	60	65	68	64	57	46	56-8-1.5	29	50	57	62	65	61	54	43
63-4-1.5	49	70	77	82	85	81	74	63	63-4-1.5	46	67	74	79	82	78	71	60
63-4-2	50	71	78	83	86	82	75	64	63-4-2	47	68	75	80	83	79	72	61
63-4-3	51	72	79	84	87	83	76	65	63-4-3	48	69	76	81	84	80	73	62
63-6-0.75	40	61	68	73	76	72	65	54	63-6-0.75	38	59	66	71	74	70	63	52
63-6-1	41	62	69	74	77	73	66	55	63-6-1	39	60	67	72	75	71	64	53
63-8-1.5	34	55	62	67	70	66	59	48	63-8-1.5	31	52	59	64	67	63	56	45
63-8-2	35	56	63	68	71	67	60	49	63-8-2	32	53	60	65	68	64	57	46
63-8-3	36	57	64	69	72	68	61	50	63-8-3	33	54	61	66	69	65	58	47
71-4-2	53	74	81	86	89	85	78	67	71-4-2	50	71	78	83	86	82	75	64
71-4-3	55	76	83	88	91	87	80	69	71-4-3	52	73	80	85	88	84	77	66
71-4-4	56	77	84	89	92	88	81	70	71-4-4	53	74	81	86	89	85	78	67
71-6-1	42	63	70	75	78	74	67	56	71-6-1	40	61	68	73	76	72	65	54
71-6-1.5	43	64	71	76	79	75	68	57	71-6-1.5	41	62	69	74	77	73	66	55
71-8-2	38	59	66	71	74	70	63	52	71-8-2	35	56	63	68	71	67	60	49
71-8-3	40	61	68	73	76	72	65	54	71-8-3	37	58	65	70	73	69	62	51
71-8-4	41	62	69	74	77	73	66	55	71-8-4	38	59	66	71	74	70	63	52
80-4-4	57	78	85	90	93	89	82	71	80-4-4	54	75	82	87	90	86	79	68
80-4-5.5	58	79	86	91	94	90	83	72	80-4-5.5	55	76	83	88	91	87	80	69
80-6-1.5	46	67	74	79	82	78	71	60	80-6-1.5	44	65	72	77	80	76	69	58
80-6-2	47	68	75	80	83	79	72	61	80-6-2	45	66	73	78	81	77	70	59
80-6-3	48	69	76	81	84	80	73	62	80-6-3	46	67	74	79	82	78	71	60
80-8-1	45	66	73	78	81	77	70	59	80-8-1	44	65	72	77	80	76	69	58
80-8-4	42	63	70	75	78	74	67	56	80-8-4	39	60	67	72	75	71	64	53
80-8-5.5	43	64	71	76	79	75	68	57	80-8-5.5	40	61	68	73	76	72	65	54
90-4-5.5	63	84	91	96	99	95	88	77	90-4-5.5	60	81	88	93	96	92	85	74
90-4-7.5	65	86	93	98	101	97	90	79	90-4-7.5	62	83	90	95	98	94	87	76
90-4-9	66	87	94	99	102	98	91	80	90-4-9	63	84	91	96	99	95	88	77
90-4-10	66	87	94	99	102	98	91	80	90-4-10	63	84	91	96	99	95	88	77
90-6-3	52	73	80	85	88	84	77	66	90-6-3	50	71	78	83	86	82	75	64
90-6-4	53	74	81	86	89	85	78	67	90-6-4	51	72	79	84	87	83	76	65
90-8-1	45	66	73	78	81	77	70	59	90-8-1	44	65	72	77	80	76	69	58
90-8-2	47	68	75	80	83	79	72	61	90-8-2	46	67	74	79	82	78	71	60
90-8-5.5	48	69	76	81	84	80	73	62	90-8-5.5	45	66	73	78	81	77	70	59
90-8-7.5	50	71	78	83	86	82	75	64	90-8-7.5	47	68	75	80	83	79	72	61
90-8-9	51	72	79	84	87	83	76	65	90-8-9	48	69	76	81	84	80	73	62
90-12-3	37	58	65	70	73	69	62	51	90-12-3	35	56	63	68	71	67	60	49
90-12-4	38	59	66	71	74	70	63	52	90-12-4	36	57	64	69	72	68	61	50
100-4-7.5	68	89	96	101	104	100	93	82	100-4-7.5	65	86	93	98	101	97	90	79
100-4-9	68	89	96	101	104	100	93	82	100-4-9	65	86	93	98	101	97	90	79
100-4-10	69	90	97	102	105	101	94	83	100-4-10	66	87	94	99	102	98	91	80
100-4-14	69	90	97	102	105	101	94	83	100-4-14	66	87	94	99	102	98	91	80
100-4-15	70	91	98	103	106	102	95	84	100-4-15	67	88	95	100	103	99	92	81
100-6-3	58	79	86	91	94	90	83	72	100-6-3	56	77	84	89	92	88	81	70
100-6-4	59	80	87	92	95	91	84	73	100-6-4	57	78	85	90	93	89	82	71
100-6-5.5	60	81	88	93	96	92	85	74	100-6-5.5	58	79	86	91	94	90	83	72
100-8-3	53	74	81	86	89	85	78	67	100-8-3	52	73	80	85	88	84	77	66
100-8-4	54	75	82	87	90	86	79	68	100-8-4	53	74	81	86	89	85	78	67
100-8-7.5	53	74	81	86	89	85	78	67	100-8-7.5	50	71	78	83	86	82	75	64
100-8-9	53	74	81	86	89	85	78	67	100-8-9	50	71	78	83	86	82	75	64
100-8-14	54	75	82	87	90	86	79	68	100-8-14	51	72	79	84	87	83	76	65
100-12-3	43	64	71	76	79	75	68	57	100-12-3	41	62	69	74	77	73	66	55
100-12-4	44	65	72	77	80	76	69	58	100-12-4	42	63	70	75	78	74	67	56
100-12-5.5	45	66	73	78	81	77	70	59	100-12-5.5	43	64	71	76	79	75	68	57
125-4T/3-10	66	73	84	94	95	90	82	78	125-4T/3-10	63	70	81	91	92	87	79	75
125-4T/3-15	67	74	85	95	96	91	83	79	125-4T/3-15	64	71	82	92	93	88	80	76
125-4T/3-20	69	76	87	97	98	93	85	81	125-4T/3-20	66	73	84	94	95	90	82	78
125-4T/6-15	63	72	87	94	97	91	85	81	125-4T/6-15	60	69	84	91	94	88	82	78
125-4T/6-20	63	72	87	94	97	91	85	81	125-4T/6-20	60	69	84	91	94	88	82	78
125-4T/9-20	62	71	87	93	95	89	84	80	125-4T/9-20	59	68	84	90	92	86	81	77
125-6T/6-5.5	56	66	78	81	83	79	68	64	125-6T/6-5.5	54	64	76	79	81	77	66	62
125-6T/6-7.5	56	66	78	81	83	79	68	64	125-6T/6-7.5	54	64	76	79	81	77	66	62
125-6T/6-10	58	68	80	83	85	81	70	66	125-6T/6-10	56	66	78	81	83	79	68	64
125-6T/6-15	60	70	82	85	87	83	72	68	125-6T/6-15	58	68	80	83	85	81	70	66
125-6T/9-7.5	54	65	79	83	83	81	70	66	125-6T/9-7.5	52	63	77	81	81	79	68	64
125-6T/9-10	54	65	79	83	83	81	70	66	125-6T/9-10	52	63	77	81	81	79	68	64
125-6T/9-15	57	68	82	86	86	84	73	69	125-6T/9-15	55	66	80	84	84	82	71	67
125-6T/9-20	60	71	85	89	89	87	76	72	125-6T/9-20	58	69	83	87	87	85	74	70
125-8T/6-4	50	59	70	75	75	69	58	54	125-8T/6-4	49	58	69	74	74	68	57	53
125-8T/6-5.5	52	61	72	77	77	71	60	56	125-8T/6-5.5	51	60	71	76	76	70	59	55
125-8T/6-7.5	54	63	74	79	79	73	62	58	125-8T/6-7.5	53	62	73	78	78	72	61	57
125-8T/6-10	55	64	75	80	80	74	63	59	125-8T/6-10	54	63	74	79	79	73	62	58
125-8T/9-5.5	49	61	70	76	78	72	61	57	125-8T/9-5.5	48	60	69	75	77	71	60	56
125-8T/9-7.5	52	64	73	79	81	75	64	60	125-8T/9-7.5	51	63	72	78	80	74	63	59
125-8T/9-10	54	66	75	81	83	77	66	62	125-8T/9-10	53	65	74	80	82	76	65	61
125-8T/9-15	55	67	76	82	84	78	67	63	125-8T/9-15	54	66	75	81	83	77	66	62

**Dimensions mm**

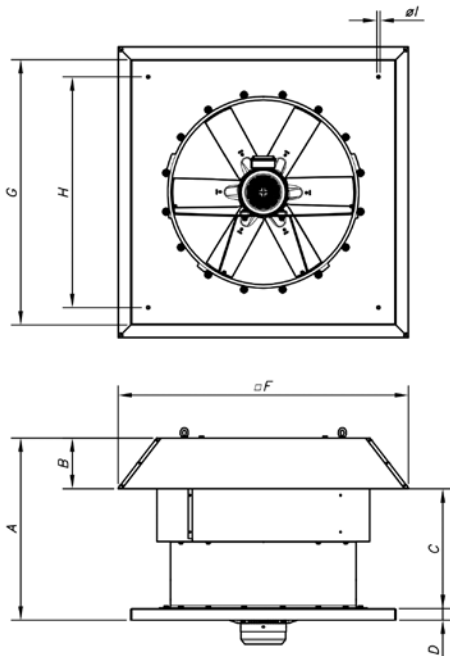

Model	A	B	C	D	F	G	H	I
HTMF-56	650	185	465	40	960	900	750	14
HTMF-63	680	215	465	40	1092	1000	850	14
HTMF-71	760	195	565	40	1120	1000	850	14
HTMF-80	790	215	575	50	1252	1150	1000	14
HTMF-90	910	232	678	50	1380	1150	1000	14
HTMF-100	1055	252	803	50	1527	1250	1100	14
HTMF-125	1170	310	859	50	1802	1425	1275	17

**Sound pressure validation depending on distance**

The noise level may vary depending on the roof or tile structure.

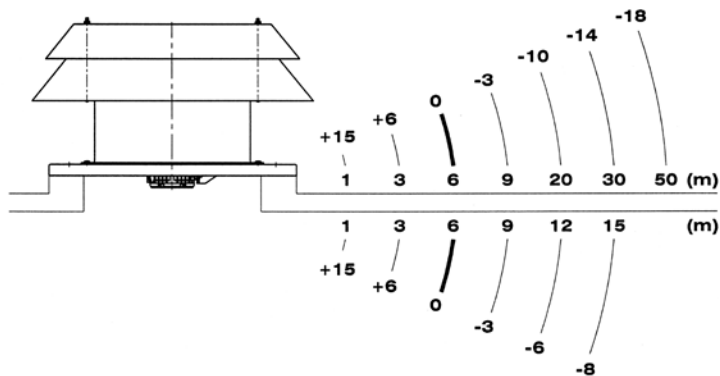

**Accessories**

See accessories section



**Characteristic curves**

Q= Flow rate in m<sup>3</sup>/h, m<sup>3</sup>/s and cfm.

Pe= Static pressure in mmH<sub>2</sub>O, Pa and inwg.

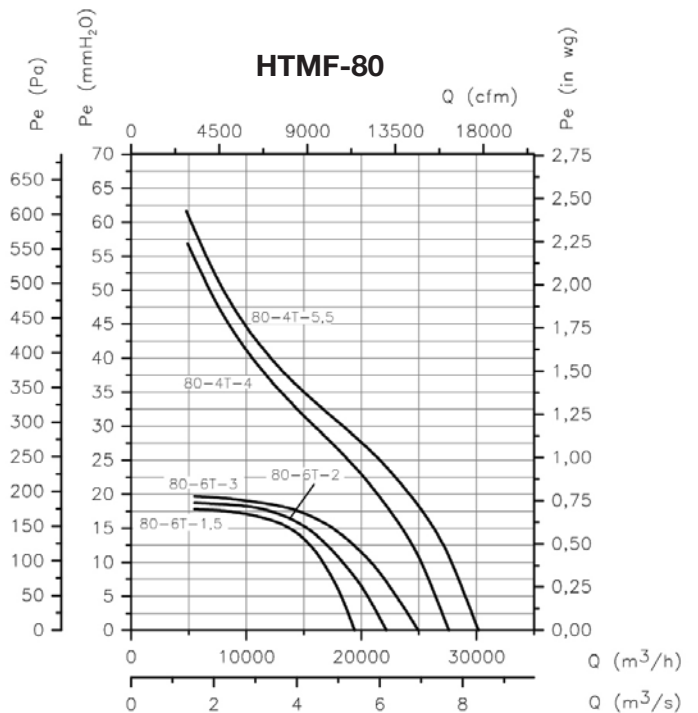
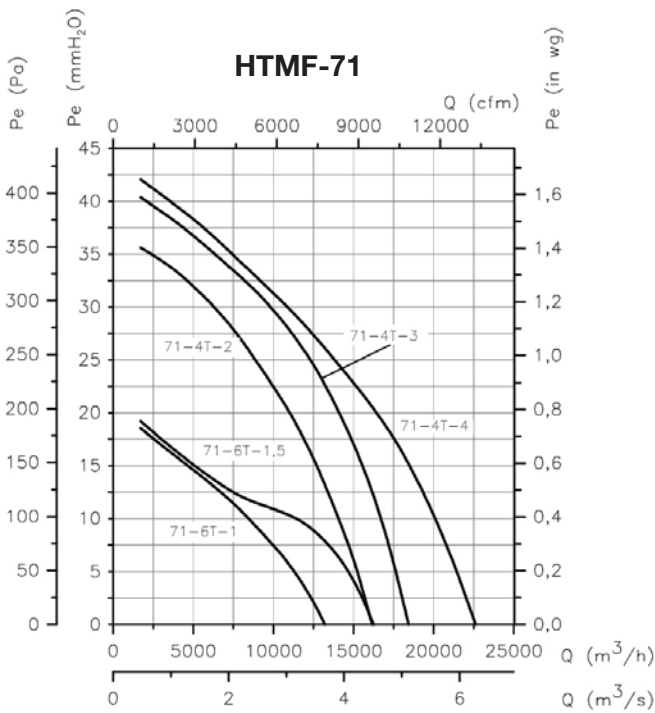
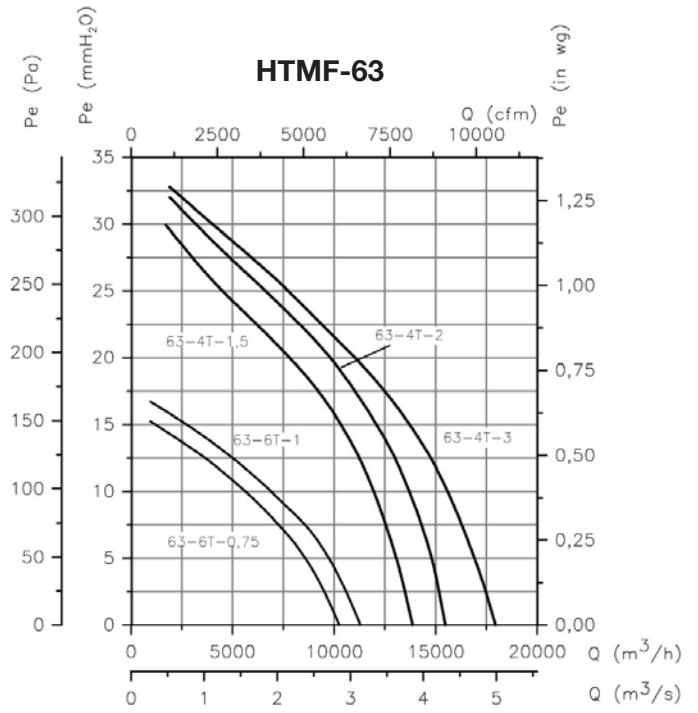
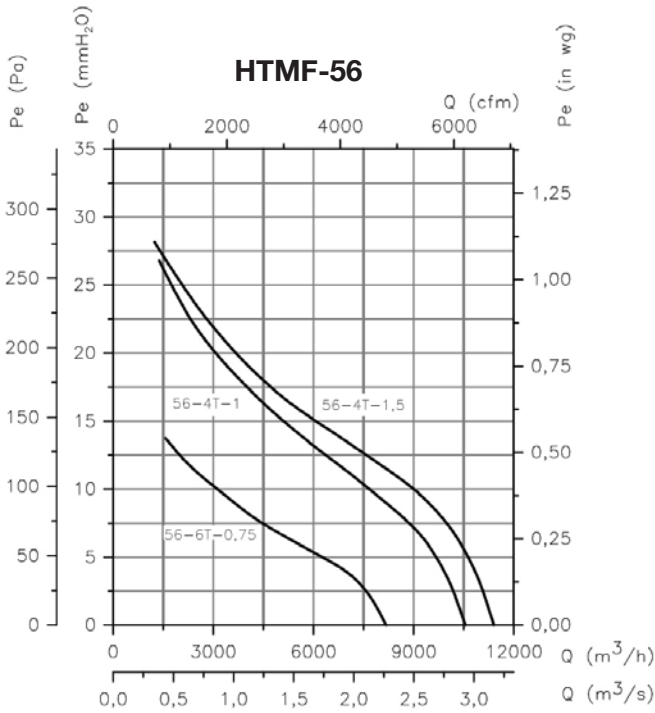

**Characteristic curves**

Q= Flow rate in m<sup>3</sup>/h, m<sup>3</sup>/s and cfm.

Pe= Static pressure in mmH<sub>2</sub>O, Pa and inwg.

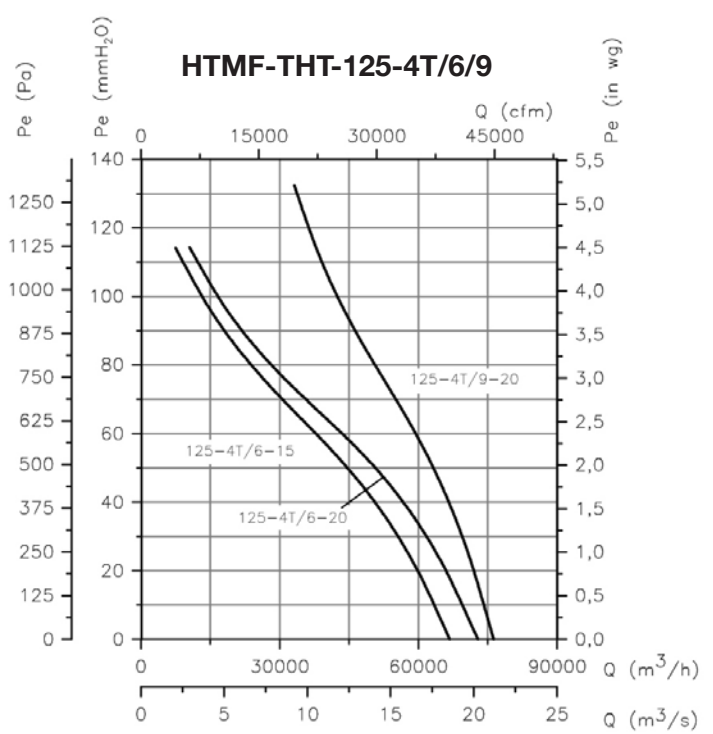
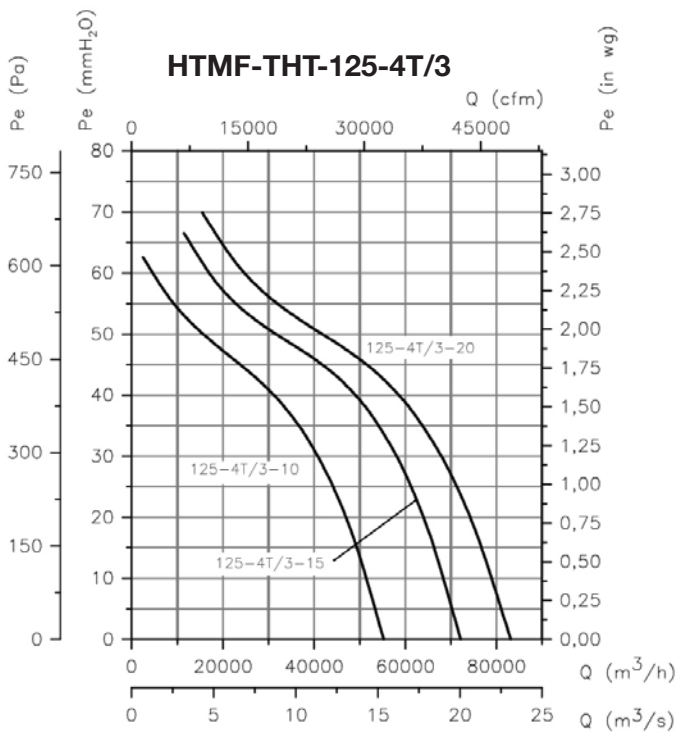
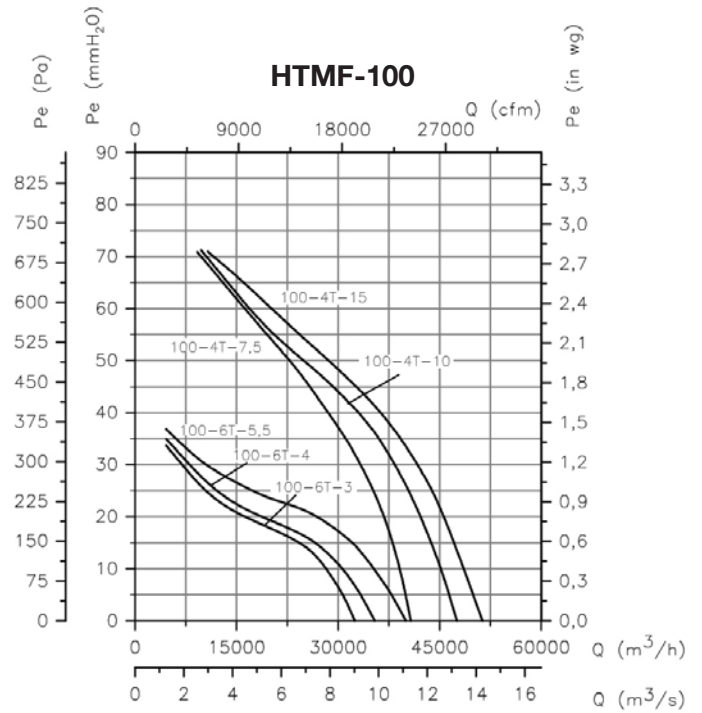
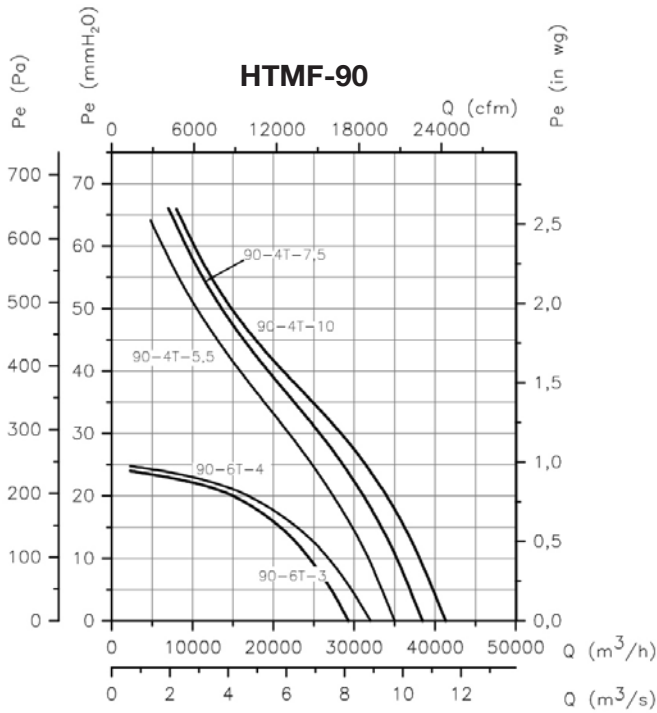

**Characteristic curves**

Q= Flow rate in m<sup>3</sup>/h, m<sup>3</sup>/s and cfm.

Pe= Static pressure in mmH<sub>2</sub>O, Pa and inwg.

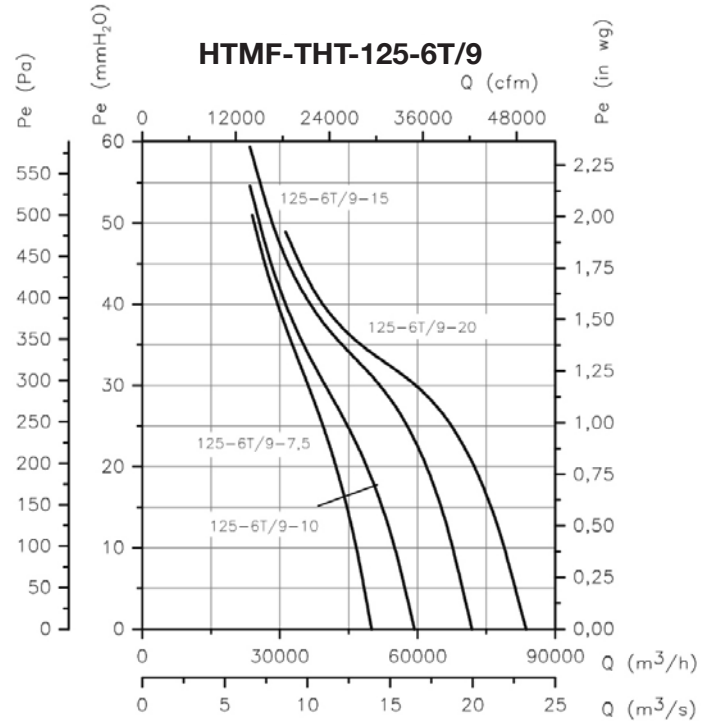
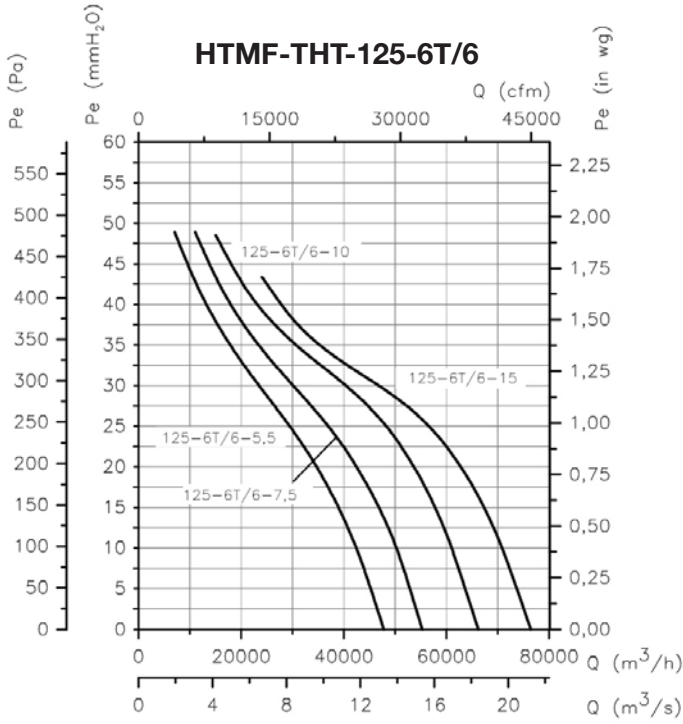

# THT/ROOF

## 400 °C/2h and 300 °C/2h roof-mounted axial extractor fans with vertical air outlet



Roof-mounted axial extractor fans with vertical air outlet, for work in fire risk zones, designed for smoke extraction in industrial or similar buildings.

**Fan:**

- Galvanised sheet steel support base with anti-corrosive treatment.
- Cast aluminium orientable rotors.
- Anti-contact protective grille pursuant to standard UNE-EN ISO 12499.
- Anti-return hatch in aluminium sheet metal to prevent the entry of water when the fan is not operating.
- Approved in accordance with standard EN 12101-3. With 0370-CPR-0305 (F400) and 0370-CPR-0973 (F300) certifications.
- Airflow direction from Motor to Impeller.

**Motor:**

- Class H motors for S1 continuous operation and S2 emergency use. With ball bearings and class IP55 protection.
- Multi voltage motor, special design valid for 220/380V 60Hz, 254/440V 60Hz, 265/460V 60Hz, 277/480V 60Hz
- Maximum temperature of air to be carried: S1 continuous operation -20 °C +40 °C. S2 operation, 300 °C/2h, 400 °C/2h.

**Finish:**

- Anti-corrosive finish of polyester resin polymerised at 190 °C, previously degreased with phosphate-free nanotechnological treatment.

**On request:**

- Extractor fans with 2-speed motors.
- 2 and 8-pole fans depending on diameter.



### Order code

From size 40 to size 100

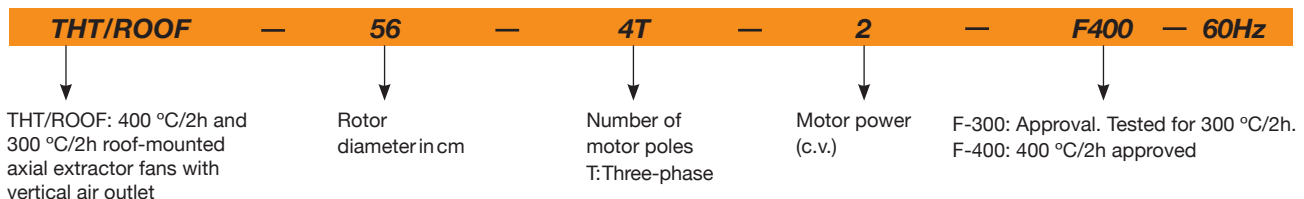

Size 120

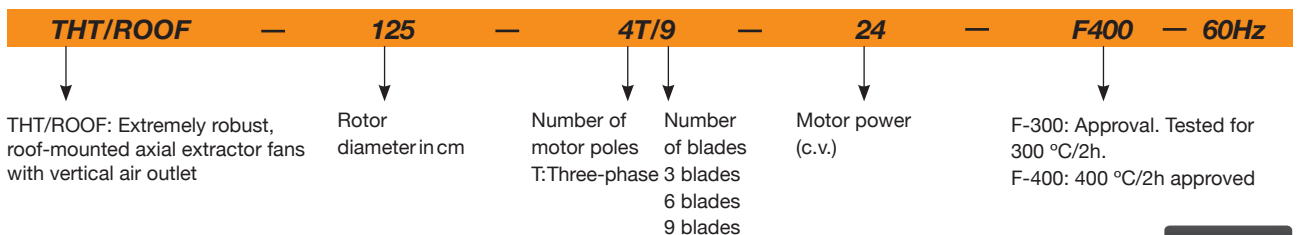

### Technical characteristics



Model	Speed (r/min)	Maximum admissible current (A)		Installed power (W)	Angle inclination blades (°)	Maximum flow rate (m3/h)	Sound pressure level dB(A) <sup>(1)</sup>		Approx. weight (kg)
		220-277V	380-480V				Intake	Discharge	
THT/ROOF-40-4T-0.75	1704	2.90	1.70	0.55	32	4800	53.55	48.3	39
THT/ROOF-40-6T-0.75	1116	3.30	1.90	0.55	32	3150	42	37.8	44
THT/ROOF-45-4T-0.75	1704	2.90	1.70	0.55	36	7450	57.75	52.5	42
THT/ROOF-45-6T-0.75	1116	3.30	1.90	0.55	30	4450	44.1	39.9	47
THT/ROOF-50-4T-1	1716	3.80	2.20	0.75	28	9750	61.95	56.7	51
THT/ROOF-50-6T-0.75	1116	3.30	1.90	0.55	32	7000	49.35	45.15	54
THT/ROOF-56-4T-1	1716	3.80	2.20	0.75	22	11250	66.15	60.9	58
THT/ROOF-56-4T-1.5	1704	4.70	2.70	1.10	30	13600	67.2	61.95	58
THT/ROOF-56-4T-2	1710	6.60	3.80	1.50	36	15050	68.25	63	61
THT/ROOF-56-6T-0.75	1116	3.30	1.90	0.55	38	10150	54.6	50.4	57
THT/ROOF-63-4T-1.5	1704	4.70	2.70	1.10	20	17800	66.15	61.95	67
THT/ROOF-63-4T-2	1710	6.60	3.80	1.50	24	19300	66.15	61.95	71
THT/ROOF-63-4T-3	1722	9.20	5.30	2.20	32	22150	68.25	64.05	76
THT/ROOF-63-4T-4	1716	11.40	6.60	3.00	38	24250	69.3	65.1	85
THT/ROOF-63-6T-0.75	1116	3.30	1.90	0.55	28	13600	57.75	53.55	67

### Technical characteristics

Model	Speed (r/min)	Maximum admissible current (A)		Installed power (W)	Angle inclination blades (°)	Maximum flow rate (m <sup>3</sup> /h)	Sound pressure level dB(A) <sup>(1)</sup>		Approx. weight (kg)
		220-277V	380-480V				Intake	Discharge	
THT/ROOF-63-6T-1	1128	4.40	2.60	0.75	38	15900	59.85	55.65	70
THT/ROOF-71-4T-2	1710	6.60	3.80	1.50	14	20900	71.4	67.2	78
THT/ROOF-71-4T-3	1722	9.20	5.30	2.20	22	25100	70.35	66.15	83
THT/ROOF-71-4T-4	1716	11.40	6.60	3.00	28	27500	71.4	67.2	92
THT/ROOF-71-6T-0.75	1116	3.30	1.90	0.55	20	16100	58.8	55.65	74
THT/ROOF-71-6T-1	1128	4.40	2.60	0.75	26	17300	59.85	55.65	77
THT/ROOF-71-6T-1.5	1134	6.40	3.70	1.10	34	19950	60.9	56.7	83
THT/ROOF-80-4T-4	1716	11.40	6.60	3.00	16	30250	74.55	70.35	114
THT/ROOF-80-4T-5.5	1728		8.40	4.00	18	32750	74.55	70.35	121
THT/ROOF-80-6T-1.5	1134	6.40	3.70	1.10	18	21450	64.05	59.85	105
THT/ROOF-80-6T-2	1134	7.40	4.30	1.50	26	25950	65.1	60.9	114
THT/ROOF-80-6T-3	1140	10.30	5.90	2.20	32	29950	66.15	61.95	120
THT/ROOF-90-4T-5.5	1728		8.40	4.00	12	38900	78.75	74.55	134
THT/ROOF-90-4T-7.5	1716		11.50	5.50	18	46150	77.7	73.5	161
THT/ROOF-90-4T-10	1752		17.70	7.50	22	50150	76.65	72.45	172
THT/ROOF-90-6T-2	1134	7.40	4.30	1.50	16	28800	67.2	63	127
THT/ROOF-90-6T-3	1140	10.30	5.90	2.20	24	34000	68.25	63	134
THT/ROOF-90-6T-4	1134	15.00	8.70	3.00	30	38900	69.3	65.1	159
THT/ROOF-100-4T-7.5	1716		11.50	5.50	10	46850	82.95	78.75	172
THT/ROOF-100-4T-10	1752		17.70	7.50	16	57400	80.85	76.65	183
THT/ROOF-100-4T-15	1746		23.00	11.00	22	66300	79.8	75.6	236
THT/ROOF-100-4T-20	1752		29.00	15.00	28	76150	81.9	77.7	251
THT/ROOF-100-6T-3	1140	10.30	5.90	2.20	16	37600	70.35	67.2	146
THT/ROOF-100-6T-4	1134	15.00	8.70	3.00	20	41150	70.35	65.1	171
THT/ROOF-100-6T-5.5	1164		11.00	4.00	26	47800	71.4	67.2	183
THT/ROOF-125-4T/3-25	1758		37.00	18.50	20	98350	85.05	79.8	404
THT/ROOF-125-4T/3-30	1764		42.00	22.00	24	110350	86.1	80.85	418
THT/ROOF-125-4T/3-40	1770		58.00	30.00	30	125000	87.15	81.9	499
THT/ROOF-125-4T/6-25	1758		37.00	18.50	14	92550	84	78.75	413
THT/ROOF-125-4T/6-30	1764		42.00	22.00	16	98850	84	78.75	427
THT/ROOF-125-4T/6-40	1770		58.00	30.00	22	117450	86.1	80.85	507
THT/ROOF-125-4T/6-50	1776		73.00	37.00	26	131050	87.15	81.9	543
THT/ROOF-125-4T/9-25	1758		37.00	18.50	10	79650	81.9	76.65	422
THT/ROOF-125-4T/9-30	1764		42.00	22.00	12	88300	82.95	77.7	436
THT/ROOF-125-4T/9-40	1770		58.00	30.00	16	104050	85.05	79.8	516
THT/ROOF-125-4T/9-50	1776		73.00	37.00	20	118400	87.15	81.9	552
THT/ROOF-125-6T/3-4	1134	15.00	8.70	3.00	12	46750	73.5	68.25	267
THT/ROOF-125-6T/3-5.5	1164		11.00	4.00	16	55400	73.5	69.3	279
THT/ROOF-125-6T/3-7.5	1164		14.00	5.50	22	68400	74.55	70.35	286
THT/ROOF-125-6T/3-10	1152		18.60	7.50	28	79150	76.65	72.45	316
THT/ROOF-125-6T/3-15	1146		26.00	11.00	34	87150	77.7	73.5	346
THT/ROOF-125-6T/3-20	1140		35.50	15.00	38	91650	78.75	74.55	404
THT/ROOF-125-6T/6-5.5	1164		11.00	4.00	10	51500	69.3	65.1	288
THT/ROOF-125-6T/6-7.5	1164		14.00	5.50	14	60650	69.3	65.1	295
THT/ROOF-125-6T/6-10	1152		18.60	7.50	20	72650	71.4	67.2	325
THT/ROOF-125-6T/6-15	1146		26.00	11.00	26	85850	73.5	69.3	355
THT/ROOF-125-6T/6-20	1140		35.50	15.00	30	92850	74.55	70.35	413
THT/ROOF-125-6T/9-10	1152		18.60	7.50	14	63500	71.4	67.2	334
THT/ROOF-125-6T/9-15	1146		26.00	11.00	20	77550	74.55	70.35	364
THT/ROOF-125-6T/9-20	1140		35.50	15.00	26	92950	77.7	73.5	422

(1) The noise level values are pressures in dB(A) measured at a distance of 6 metres in a free field.

### Acoustic characteristics

#### Sound power spectrum Lw(A) in dB(A) per Hz frequency band

Values taken during intake with maximum flow rate

Model	63	125	250	500	1000	2000	4000	8000
40-4-0.75	36	57	64	69	72	68	61	50
40-6-0.75	25	46	53	58	61	57	50	39
45-4-0.75	40	61	68	73	76	72	65	54
45-6-0.75	27	48	55	60	63	59	52	41
50-4-1	44	64	72	77	79	76	69	58
50-6-0.75	32	52	60	65	67	64	57	46
56-4-1	48	68	76	81	83	80	73	62
56-4-1.5	49	69	77	82	84	81	74	63
56-4-2	50	70	78	83	85	82	75	64
56-6-0.75	37	57	65	70	72	69	62	51
63-4-1.5	48	68	76	81	83	80	73	65
63-4-2	52	68	76	81	83	80	73	66
63-4-3	53	70	78	83	85	82	77	67
63-4-4	54	71	79	84	86	83	78	68
63-6-0.75	42	60	68	73	75	72	65	56

Values taken during discharge with maximum flow rate

Model	63	125	250	500	1000	2000	4000	8000
40-4-0.75	31	52	59	64	67	63	56	45
40-6-0.75	21	42	49	54	57	53	46	35
45-4-0.75	35	56	63	68	71	67	60	49
45-6-0.75	23	44	51	56	59	55	48	37
50-4-1	39	59	67	72	74	71	64	53
50-6-0.75	28	48	56	61	63	60	53	42
56-4-1	43	63	71	76	78	75	68	57
56-4-1.5	44	64	72	77	79	76	69	58
56-4-2	45	65	73	78	80	77	70	59
56-6-0.75	33	53	61	66	68	65	58	47
63-4-1.5	44	64	72	77	79	76	69	60
63-4-2	47	64	72	77	79	76	69	61
63-4-3	48	66	74	79	81	78	73	62
63-4-4	49	67	75	80	82	79	74	63
63-6-0.75	38	56	64	69	71	68	61	52



Acoustic characteristics

Sound power spectrum Lw(A) in dB(A) per Hz frequency band

Values taken during intake with maximum flow rate

Model	63	125	250	500	1000	2000	4000	8000
63-6-1	43	62	70	75	77	74	67	57
71-4-2	53	73	81	86	88	85	78	70
71-4-3	58	72	80	85	87	84	77	71
71-4-4	59	73	81	86	88	85	78	72
71-6-0,75	44	63	72	74	76	73	66	55
71-6-1	45	65	73	75	77	74	67	56
71-6-1.5	46	66	71	76	78	75	68	57
80-4-4	56	76	84	89	91	88	81	74
80-4-5.5	56	76	84	89	91	88	81	74
80-6-1.5	49	66	74	79	81	78	71	60
80-6-2	50	67	75	80	82	79	72	61
80-6-3	51	68	76	81	83	80	73	62
90-4-5.5	60	81	88	93	96	92	85	74
90-4-7.5	59	80	87	92	95	91	84	73
90-4-10	58	79	86	91	94	90	83	72
90-6-2	49	70	77	82	85	81	74	63
90-6-3	56	70	77	82	85	81	74	63
90-6-4	57	72	79	84	87	83	76	65
100-4-7.5	64	84	92	97	99	96	89	78
100-4-10	62	82	90	95	97	94	87	76
100-4-15	61	81	89	94	96	93	86	75
100-4-20	63	83	91	96	98	95	88	77
100-6-3	61	72	80	85	87	84	77	66
100-6-4	64	72	80	85	87	84	77	66
100-6-5.5	64	73	81	86	88	85	78	67
125-4/3-25	73	79	91	101	101	97	89	85
125-4/3-30	74	80	92	102	102	98	90	86
125-4/3-40	75	81	93	103	103	99	91	87
125-4/6-25	68	76	92	99	101	96	90	86
125-4/6-30	68	76	92	99	101	96	90	86
125-4/6-40	70	78	94	101	103	98	92	88
125-4/6-50	71	79	95	102	104	99	93	89
125-4/9-25	66	74	91	97	98	93	88	84
125-4/9-30	67	75	92	98	99	94	89	85
125-4/9-40	69	77	94	100	101	96	91	87
125-4/9-50	71	79	96	102	103	98	93	89
125-6/3-4	66	74	86	90	88	83	74	70
125-6/3-5.5	66	74	86	90	88	83	74	70
125-6/3-7.5	67	75	87	91	89	84	75	71
125-6/3-10	69	77	89	93	91	86	77	73
125-6/3-15	70	78	90	94	92	87	78	74
125-6/3-20	71	79	91	95	93	88	79	75
125-6/6-5.5	60	69	82	85	86	83	72	68
125-6/6-7.5	60	69	82	85	86	83	72	68
125-6/6-10	62	71	84	87	88	85	74	70
125-6/6-15	64	73	86	89	90	87	76	72
125-6/6-20	65	74	87	90	91	88	77	73
125-6/9-10	58	68	83	87	86	85	74	70
125-6/9-15	61	71	86	90	89	88	77	73
125-6/9-20	64	74	89	93	92	91	80	76

Values taken during discharge with maximum flow rate

Model	63	125	250	500	1000	2000	4000	8000
63-6-1	39	58	66	71	73	70	63	53
71-4-2	49	69	77	82	84	81	74	65
71-4-3	53	68	76	81	83	80	73	67
71-4-4	54	69	77	82	84	81	74	68
71-6-0,75	40	60	68	71	73	70	63	52
71-6-1	41	61	69	71	73	70	63	52
71-6-1.5	42	62	67	72	74	71	64	53
80-4-4	52	72	80	85	87	84	77	69
80-4-5.5	52	72	80	85	87	84	77	70
80-6-1.5	45	62	70	75	77	74	67	56
80-6-2	46	63	71	76	78	75	68	57
80-6-3	47	64	72	77	79	76	69	58
90-4-5.5	56	77	84	89	92	88	81	70
90-4-7.5	55	76	83	88	91	87	80	69
90-4-10	54	75	82	87	90	86	79	68
90-6-2	45	66	73	78	81	77	70	59
90-6-3	52	66	73	78	81	77	70	59
90-6-4	53	68	75	80	83	79	72	61
100-4-7.5	60	80	88	93	95	92	85	74
100-4-10	58	78	86	91	93	90	83	72
100-4-15	57	77	85	90	92	89	82	71
100-4-20	59	79	87	92	94	91	84	73
100-6-3	58	69	77	82	84	81	74	63
100-6-4	59	67	75	80	82	79	72	61
100-6-5.5	60	69	77	82	84	81	74	63
125-4/3-25	68	74	86	96	96	92	84	80
125-4/3-30	69	75	87	97	97	93	85	81
125-4/3-40	70	76	88	98	98	94	86	82
125-4/6-25	63	71	87	94	96	91	85	81
125-4/6-30	63	71	87	94	96	91	85	81
125-4/6-40	65	73	89	96	98	93	87	83
125-4/6-50	66	74	90	97	99	94	88	84
125-4/9-25	61	69	86	92	93	88	83	79
125-4/9-30	62	70	87	93	94	89	84	80
125-4/9-40	64	72	89	95	96	91	86	82
125-4/9-50	66	74	91	97	98	93	88	84
125-6/3-4	61	69	81	85	83	78	69	65
125-6/3-5.5	62	70	82	86	84	79	70	66
125-6/3-7.5	63	71	83	87	85	80	71	67
125-6/3-10	65	73	85	89	87	82	73	69
125-6/3-15	66	74	86	90	88	83	74	70
125-6/3-20	67	75	87	91	89	84	75	71
125-6/6-5.5	56	65	78	81	82	79	68	64
125-6/6-7.5	56	65	78	81	82	79	68	64
125-6/6-10	58	67	80	83	84	81	70	66
125-6/6-15	60	69	82	85	86	83	72	68
125-6/6-20	61	70	83	86	87	84	73	69
125-6/9-10	54	64	79	83	82	81	70	66
125-6/9-15	57	67	82	86	85	84	73	69
125-6/9-20	60	70	85	89	88	87	76	72

Dimensions mm

Model	A	B	C	D	ØF	G	H	ØI
THT/ROOF-40	628	349	244	35	519	630	530	12
THT/ROOF-45	642	363	244	35	569	710	590	12
THT/ROOF-50	679	400	244	35	626	900	750	12
THT/ROOF-56	710	426	244	40	686	900	750	14
THT/ROOF-63	747	463	244	40	753	1000	850	14
THT/ROOF-71	830	498	292	40	833	1000	850	14
THT/ROOF-80	887	545	292	50	923	1150	1000	14
THT/ROOF-90	989	601	338	50	1031	1150	1000	14
THT/ROOF-100	1136	648	438	50	1128	1250	1100	14
THT/ROOF-125	1313	775	488	50	1376	1425	1275	17

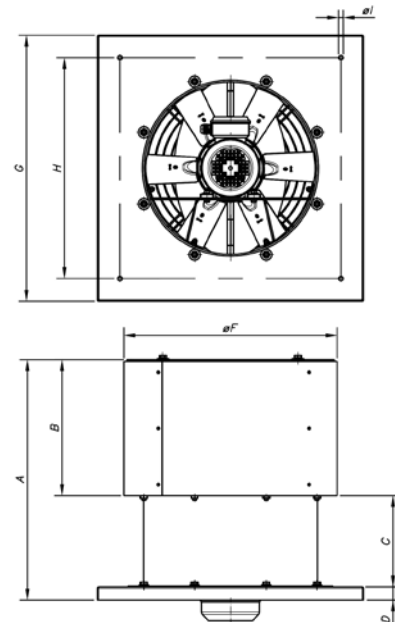

Characteristic curves

See HTMV series

Accessories



# TCR/R CJTCR/R



TCR/R



CJTCR/R

## 400 °C/2h centrifugal extractor fans and extractor fan units with reaction impeller

TCR/R: 400 °C/2h centrifugal, single inlet extractor fans for operation outside the fire risk zone, with extreme robustness and fitted with a backward-curved impeller

CJTCR/R: Extremely robust 400 °C/2h single inlet extractor fan units with acoustically insulated box, for outdoor operation in fire risk zones

### Fan:

- Sheet steel casing.
- Impeller with reaction blades in robust sheet steel, coated with heat resistant paint.
- Approved in accordance with standard EN 12101-3, with certificate no.: 0370-CPR-0400 (TCR/R) and 0370-CPR-0401 (CJTCR/R).

### Motor:

- Class F motors with ball bearings and IP55 protection.
- Multi voltage motor, special design valid for 220/380V 60Hz, 254/440V 60Hz, 265/460V 60Hz, 277/480V 60Hz
- Maximum temperature of air to be carried: S1 continuous operation -20 °C +250 °C, S2 operation 300 °C/2h and 400 °C/2h.

### Finish:

- Anti-corrosive finish of polyester resin polymerised at 190 °C, previously degreased with phosphate-free nanotechnological treatment.
- CJTCR/R: Anti-corrosive finished galvanised sheet steel.

### On request:

- Extractor fans with 2-speed motors.
- Belt-driven extractor fans.



Extremely robust,  
high performance  
reaction impeller



## Order code

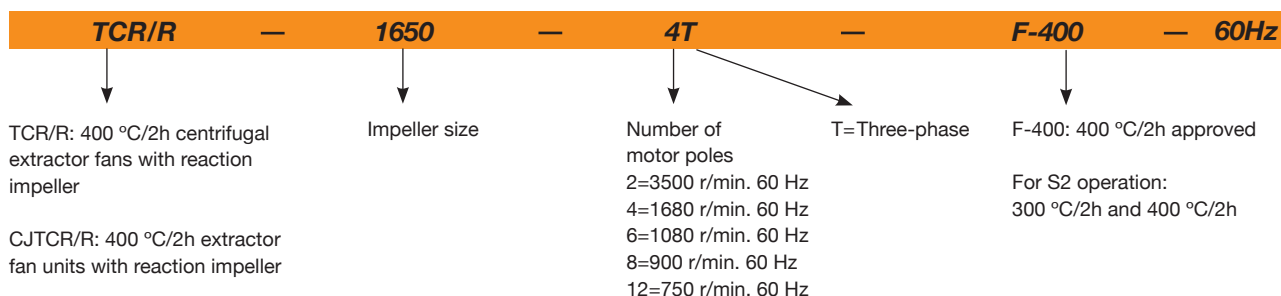

**Technical characteristics**

Model	Speed (r/min)	Maximum admissible current (A)		Installed power (kW)	Maximum flow rate (m3/h)	Sound pressure level dB(A)		Approx. weight (Kg)	
		220-277V	380-480V			TCR/R	CJTCR/R	TCR/R	CJTCR/R
TCR/R CJTCR/R 1240-2T	3474	13.16	7.6	4	11100	86	81	93	147
TCR/R CJTCR/R 1240-4T	1692	3.29	1.9	0.75	5800	71	66	71	125
TCR/R CJTCR/R 1445-2T	3432		13.9	7.5	16500	87	82	126	210
TCR/R CJTCR/R 1445-4T	1692	4.49	2.59	1.1	8030	72	67	93	177
TCR/R CJTCR/R 1650-4T	1704	5.98	3.45	1.5	10500	74	68	114	189
TCR/R CJTCR/R 1650-6T	1116	4.09	2.36	0.75	7410	64	59	111	186
TCR/R CJTCR/R 1856-4T	1716	11.22	6.48	3	15150	79	74	152	273
TCR/R CJTCR/R 1856-6T	1116	5.63	3.25	1.1	10050	70	65	145	266
TCR/R CJTCR/R 2063-4T	1740		11.1	5.5	24450	80	75	225	380
TCR/R CJTCR/R 2063-6T	1140	6.79	3.92	1.5	16100	71	66	209	364
TCR/R CJTCR/R 2271-4T	1752		22	11	34610	85	79	315	508
TCR/R CJTCR/R 2271-6T	1152	11.95	6.9	3	22750	76	71	280	473

**Acoustic characteristics**

The indicated values are determined by measuring the sound pressure level and sound power in dB(A) obtained in a free field at a distance equivalent to twice the size of the fan plus the impeller diameter, with a minimum of 1.5 m.

Sound power spectrum Lw(A) in dB(A) per Hz frequency band

Model TCR/R	63	125	250	500	1000	2000	4000	8000	Model CJTCR/R	63	125	250	500	1000	2000	4000	8000
1240-2	68	83	81	93	90	94	96	83	1240-2	63	78	76	88	85	89	91	78
1240-4	56	40	76	79	79	80	70	59	1240-4	51	65	71	74	74	75	65	54
1445-2	73	85	83	95	93	97	99	89	1445-2	68	80	78	90	88	92	94	84
1445-4	59	72	78	83	80	83	78	64	1445-4	54	67	73	78	75	78	73	59
1650-4	64	74	82	84	83	85	76	66	1650-4	58	68	76	78	77	79	70	60
1650-6	53	65	72	77	73	69	62	54	1650-6	48	60	67	72	68	64	57	49
1856-4	69	78	91	87	90	91	85	71	1856-4	64	73	86	82	85	86	80	66
1856-6	61	69	81	83	80	81	71	60	1856-6	56	64	76	78	75	76	66	55
2063-4	80	85	91	93	91	88	81	73	2063-4	75	80	86	88	86	83	76	68
2063-6	69	70	82	82	81	83	73	63	2063-6	64	65	77	77	76	78	68	58
2271-4	83	84	93	96	98	99	95	82	2271-4	77	78	87	90	92	93	89	76
2271-6	73	73	87	86	90	90	79	68	2271-6	68	68	82	81	85	85	74	63

**Orientation**

Standard supply LG 270



Dimensions mm

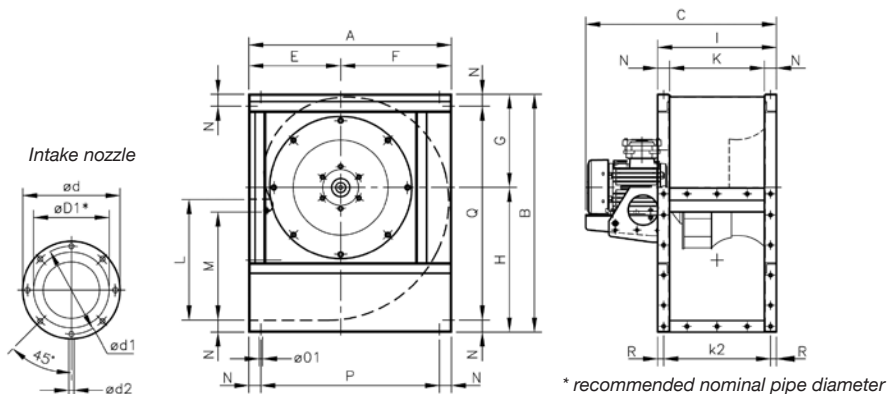

\* recommended nominal pipe diameter

Model	A	B	C	ØD1*	Ød	Ød1	Ød2	E	F	G	H	I	M	N	Ø01	P	Q	R
TCR/R 1240-2T	673	790	734	400	472	444	M.8	305	368	310	480	395	358.5	40	11	593	710	20
TCR/R 1240-4T	673	790	634	400	472	444	M.8	305	368	310	480	395	358.5	40	11	593	710	20
TCR/R 1445-2T	765	880	815	450	522	494	M.8	350	415	339	541	445	407	45	11	675	790	20
TCR/R 1445-4T	765	880	727	450	522	494	M.8	350	415	339	541	445	407	45	11	675	790	20
TCR/R 1650-4T	832	970	770.5	500	582	555	M.10	375	457	378	592	490	445	45	13	742	880	20
TCR/R 1650-6T	832	970	770.5	500	582	555	M.10	375	457	378	592	490	445	45	13	742	880	20
TCR/R 1856-4T	925	1084	857.5	560	645	615	M.10	415	510	424	660	550	493	50	13	825	984	25
TCR/R 1856-6T	925	1084	828	560	645	615	M.10	415	510	424	660	550	493	50	13	825	984	25
TCR/R 2063-4T	1037	1218	955	630	720	688	M.10	465	572	477	741	620	530	60	13	917	1098	30
TCR/R 2063-6T	1037	1218	932	630	720	688	M.10	465	572	477	741	620	530	60	13	917	1098	30
TCR/R 2271-4T	1173	1375	1149	710	800	768	M.12	525	648	538	837	690	603.5	65	13	1043	1245	32.5
TCR/R 2271-6T	1173	1375	1112	710	800	768	M.12	525	648	538	837	690	603.5	65	13	1043	1245	32.5

Impulsion nozzle

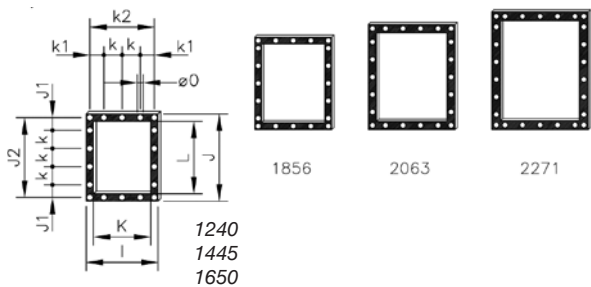

Model	I	J	J1	J2	K	k	k1	k2	L	Ø0
TCR/R-1240	395	480	70	440	315	100	77.5	355	400	11
TCR/R-1445	445	540	99	498	355	100	102.5	405	450	11
TCR/R-1650	490	590	87.5	550	400	125	100	450	500	13
TCR/R-1856	550	660	55	610	450	125	125	500	560	13
TCR/R-2063	620	750	95	690	500	125	92.5	560	630	13
TCR/R-2271	690	840	75	775	560	125	62.5	625	710	13

Standard supply: LG-270

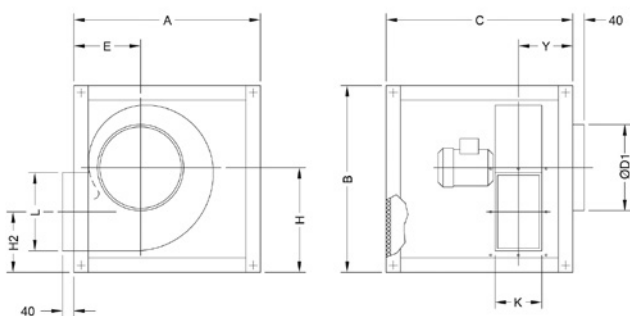

Model	A	B	C	ØD1	E	H	H2	K	L	Y
CJTCR/R-1240	970	970	970	400	312	549	308	315	400	307.5
CJTCR/R-1445	1070	1070	1070	450	357	610	339	355	450	333.5
CJTCR/R-1650	1160	1160	1160	500	382	660	365	400	500	355
CJTCR/R-1856	1260	1260	1050	560	422	727	399	450	560	360
CJTCR/R-2063	1400	1400	1200	630	472	810	444	500	630	395
CJTCR/R-2271	1555	1555	1355	710	532	906	560	560	715	430

Dimensions mm

Supply on request: LG-0

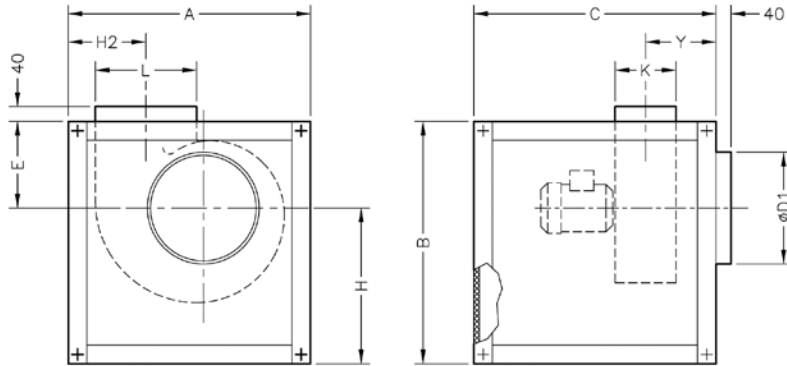

Model	A	B	C	ØD1	E	H	H2	K	L	Y
CJTTCR/R-1240	970	970	970	400	533	437	322	315	400	307.5
CJTTCR/R-1445	1070	1070	1070	450	586	484	367	355	450	333.5
CJTTCR/R-1650	1160	1160	1160	500	634.5	525.5	391.5	400	500	355
CJTTCR/R-1856	1260	1260	1050	560	681.5	578.5	442.5	450	560	360
CJTTCR/R-2063	1400	1400	1200	630	759	641	482	500	630	395
CJTTCR/R-2271	1555	1555	1355	710	838	717	518.5	560	715	430

Supply on request: LG-90

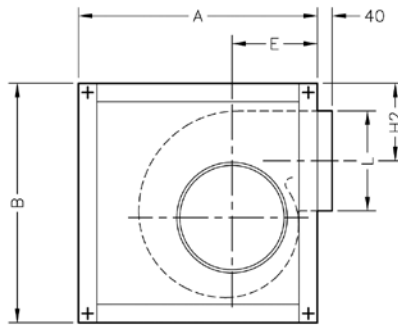
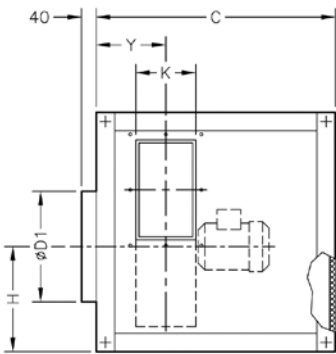

Detail of impulsion nozzle holes

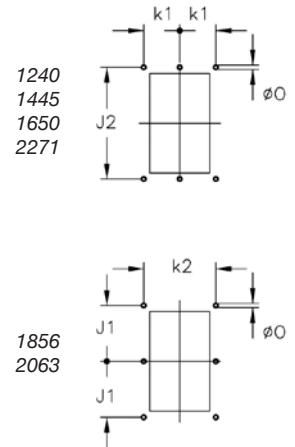

Model	A	B	C	ØD1	E	H	H2	K	L	Y
CJTTCR/R-1240	970	970	970	400	312	379	350	315	400	307.5
CJTTCR/R-1445	1070	1070	1070	450	357	408	391	355	450	333.5
CJTTCR/R-1650	1160	1160	1160	500	382	447	419	400	500	355
CJTTCR/R-1856	1260	1260	1050	560	422	495	438	450	560	360
CJTTCR/R-2063	1400	1400	1200	630	472	546	488	500	630	395
CJTTCR/R-2271	1555	1555	1355	710	532	607	532	560	715	430

Model	k1	k2	J1	J2	Ø0
CJTTCR/R-1240	177.5	-	-	440	11
CJTTCR/R-1445	202.5	-	-	498	11
CJTTCR/R-1650	225	-	-	550	13
CJTTCR/R-1856	-	500	305	-	13
CJTTCR/R-2063	-	560	345	-	13
CJTTCR/R-2271	312.5	-	-	775	13

**Characteristic curves**

Q= Flow rate in m<sup>3</sup>/h, m<sup>3</sup>/s and cfm.

Pe= Static pressure in mmH<sub>2</sub>O, Pa and in.wg.

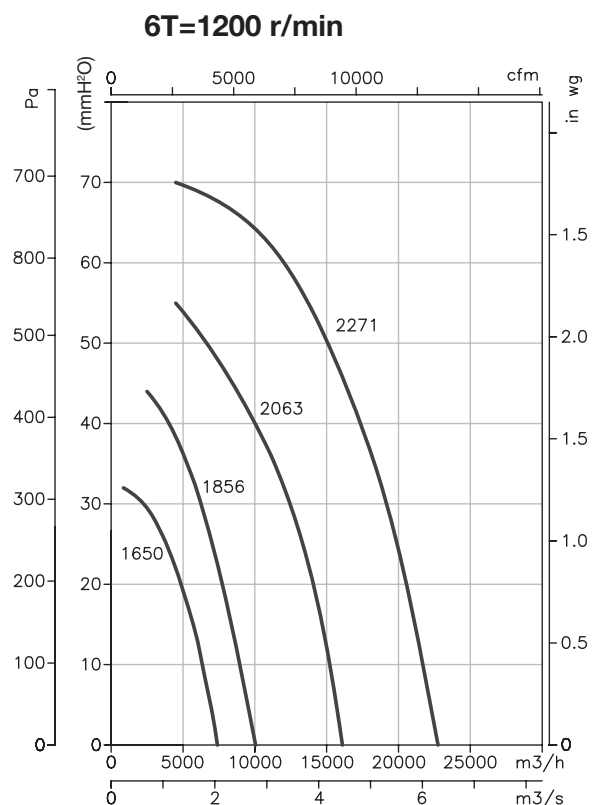
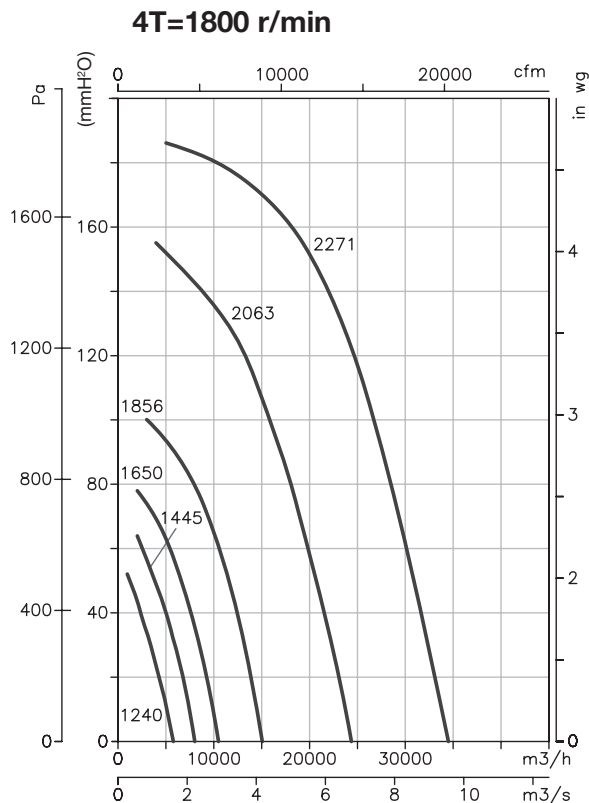
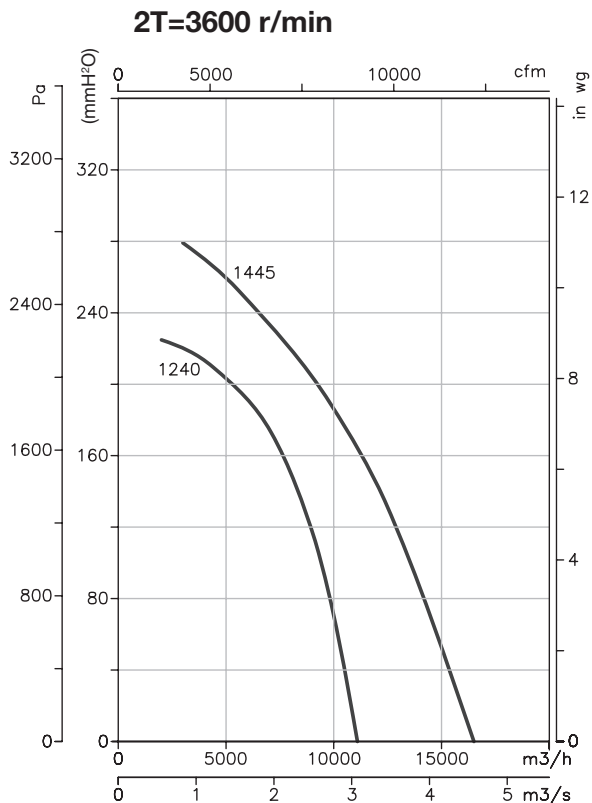

**Accessories**



# CJTX-C



## 400 °C/2h belt-driven double inlet extractor fan units

400 °C/2h extractor fan units, with motor and transmission mounted inside the box, for outdoor operation in fire risk zones.

### Fan:

- Galvanised sheet steel structure.
- Forward-curved impeller made of galvanised sheet steel.
- Approved in accordance with standard EN 12101-3, with certificate no.: 0370-CPR-0468.
- Linear air flow direction.

### Motor:

- Class F motors with ball bearings, IP55 protection and with 1 or 2 speeds, depending on model.
- Multi voltage motor, special design valid for 220/380V 60Hz, 254/440V 60Hz, 265/460V 60Hz, 277/480V 60Hz
- Maximum temperature of air to be carried: S1 continuous operation -20 °C +120 °C, S2 operation 300 °C/2h and 400 °C/2h.

### Finish:

- Anti-corrosive finished galvanised sheet steel.

### On request:

- Vertical outlet extractor fans



## Order code

<b>CJTX-C</b>	—	<b>15/15</b>	—	<b>0.75</b>	—	<b>F-400</b>	—	<b>60Hz</b>
↓		↓		↓		↓		
400 °C/2h belt-driven double inlet extractor fan units		Impeller size		Motor power (hp)		F-400: 400 °C/2h approved		
						For S2 operation: 300 °C/2h and 400 °C/2h		

## Technical characteristics

**60Hz**

Model	Speed (r/min)	Maximum admissible current (A)		Installed power (kW)	Maximum flow rate (m <sup>3</sup> /h)	Sound pressure level dB(A)	Approx. weight (kg)
		220-277V	380-480V				
CJTX-C-7/7-0.25	1000	1.03	0.59	0.18	1600	58	53
CJTX-C-7/7-0.33	1200	1.30	0.75	0.25	1825	60	54
CJTX-C-7/7-0.5	1400	1.85	1.06	0.37	2100	64	54
CJTX-C-7/7-0.75	1600	2.59	1.49	0.55	2350	67	58
CJTX-C-7/7-1	1800	2.96	1.71	0.75	2600	69	62
CJTX-C-9/9-0.33	850	1.30	0.75	0.25	2300	58	65
CJTX-C-9/9-0.5	960	1.85	1.06	0.37	2800	61	66
CJTX-C-9/9-0.75	1060	2.59	1.49	0.55	3200	65	69
CJTX-C-9/9-1	1200	2.96	1.71	0.75	3500	67	73
CJTX-C-9/9-1.5	1340	4.38	2.53	1.10	4100	70	80
CJTX-C-9/9-2	1500	5.53	3.19	1.50	4400	72	84
CJTX-C-10/10-0.33	660	1.30	0.75	0.25	2800	57	77
CJTX-C-10/10-0.5	800	1.85	1.06	0.37	3300	61	77
CJTX-C-10/10-0.75	880	2.59	1.49	0.55	3800	63	81
CJTX-C-10/10-1	1000	2.96	1.71	0.75	4200	65	85
CJTX-C-10/10-1.5	1130	4.38	2.53	1.10	4800	68	92

### Technical characteristics

Model	Speed (r/min)	Maximum admissible current (A)		Installed power (kW)	Maximum flow rate (m <sup>3</sup> /h)	Sound pressure level dB(A)	Approx. weight (kg)
		220-277V	380-480V				
CJTX-C-10/10-2	1270	5.53	3.19	1.50	5300	71	94
CJTX-C-10/10-3	1450	8.40	4.85	2.20	5900	74	89
CJTX-C-12/12-0.5	600	1.85	1.06	0.37	4200	60	96
CJTX-C-12/12-0.75	700	2.59	1.49	0.55	4600	63	99
CJTX-C-12/12-1	800	2.96	1.71	0.75	5100	65	104
CJTX-C-12/12-1.5	880	4.38	2.53	1.10	5700	68	111
CJTX-C-12/12-2	1020	5.53	3.19	1.50	6400	70	113
CJTX-C-12/12-3	1140	8.40	4.85	2.20	7400	73	107
CJTX-C-12/12-4	1250	11.22	6.48	3.00	8200	75	115
CJTX-C-15/15-0.75	530	2.59	1.49	0.55	4700	59	126
CJTX-C-15/15-1	560	2.96	1.71	0.75	6000	61	130
CJTX-C-15/15-1.5	630	4.38	2.53	1.10	7000	64	138
CJTX-C-15/15-2	700	5.53	3.19	1.50	7800	66	141
CJTX-C-15/15-3	800	8.40	4.85	2.20	9000	69	135
CJTX-C-15/15-4	880	11.22	6.48	3.00	10000	72	144
CJTX-C-15/15-5.5	970	14.98	8.65	4.00	11000	73	145
CJTX-C-18/18-1	460	2.96	1.71	0.75	7500	60	163
CJTX-C-18/18-1.5	510	4.38	2.53	1.10	9000	61	171
CJTX-C-18/18-2	540	5.53	3.19	1.50	10800	64	175
CJTX-C-18/18-3	610	8.40	4.85	2.20	12500	67	170
CJTX-C-18/18-4	680	11.22	6.48	3.00	14000	70	177
CJTX-C-18/18-5.5	750	14.98	8.65	4.00	15000	72	178
CJTX-C-18/18-7.5	850		11.40	5.50	16500	74	188
CJTX-C-18/18-10	930		14.80	7.50	18000	77	202
CJTX-C-20/20-2	450	5.53	3.19	1.50	13000	64	276
CJTX-C-20/20-3	530	8.40	4.85	2.20	15000	68	270
CJTX-C-20/20-4	580	11.22	6.48	3.00	16300	70	277
CJTX-C-20/20-5.5	660	14.98	8.65	4.00	18000	72	279
CJTX-C-20/20-7.5	740		11.40	5.50	20500	74	289
CJTX-C-20/20-10	815		14.80	7.50	22500	77	304
CJTX-C-22/22-2	380	5.53	3.19	1.50	14000	62	318
CJTX-C-22/22-3	430	8.40	4.85	2.20	16000	64	312
CJTX-C-22/22-4	480	11.22	6.48	3.00	18000	68	320
CJTX-C-22/22-5.5	520	14.98	8.65	4.00	20000	69	323
CJTX-C-22/22-7.5	580		11.40	5.50	22500	72	333
CJTX-C-22/22-10	650		14.80	7.50	25000	74	346
CJTX-C-22/22-15	740		21.00	11.00	28000	77	358
CJTX-C-22/22-20	780		28.60	15.00	31000	79	424
CJTX-C-25/25-3	340	8.40	4.85	2.20	20000	66	369
CJTX-C-25/25-4	380	11.22	6.48	3.00	22000	68	376
CJTX-C-25/25-5.5	420	14.98	8.65	4.00	24000	70	377
CJTX-C-25/25-7.5	470		11.40	5.50	26500	73	393
CJTX-C-25/25-10	510		14.80	7.50	29000	75	401
CJTX-C-25/25-15	570		21.00	11.00	34000	78	419
CJTX-C-25/25-20	630		28.60	15.00	38000	80	482
CJTX-C-30/28-3	250	8.40	4.85	2.20	25000	64	502
CJTX-C-30/28-4	280	11.22	6.48	3.00	27000	66	516
CJTX-C-30/28-5.5	340	14.98	8.65	4.00	29000	68	517
CJTX-C-30/28-7.5	360		11.40	5.50	32500	71	530
CJTX-C-30/28-10	410		14.80	7.50	36000	73	545
CJTX-C-30/28-15	480		21.00	11.00	40000	76	557
CJTX-C-30/28-20	520		28.60	15.00	45000	78	627
CJTX-C-30/28-25	550		36.00	18.50	49000	79	609



Dimensions mm

Standard supply horizontal impulsion (H): LG-90

PLAN VIEW

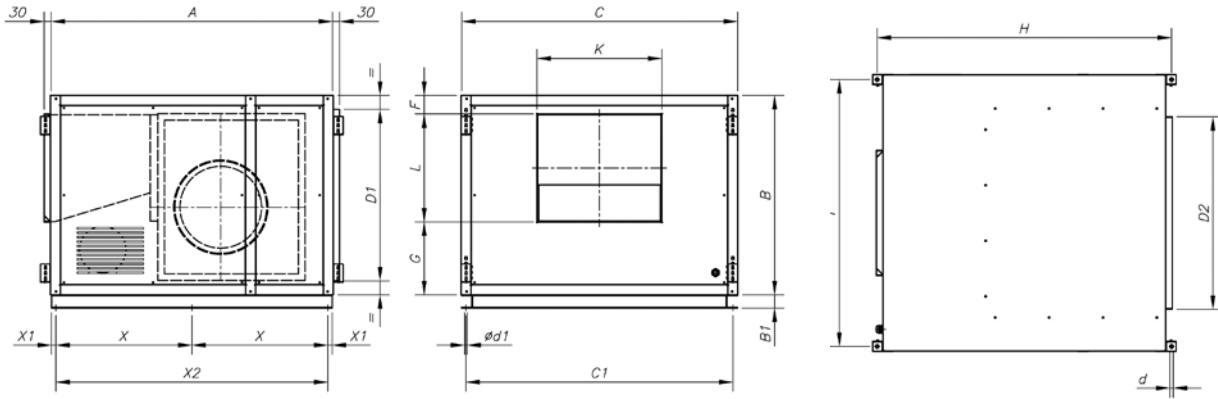

Model	A	B	B1	C	C1	ød	ød1	D1	D2	F	G	H	I	K	L	X	X1	X2
CJTX-C-7/7	700	480	-	730	695	10,5	9	354	470	62	202	750	685	239	216	-	-	-
CJTX-C-9/9	785	592	-	759	716	10,5	9	466	490	92	230	835	714	305	270	-	-	-
CJTX-C-10/10	860	618	-	825	782	10,5	9	492	520	87	235	910	780	334	296	-	-	-
CJTX-C-12/12	970	680	-	945	902	10,5	9	554	620	80	250	1020	900	395	350	-	-	-
CJTX-C-15/15	1100	776	-	1100	1057	10,5	9	650	720	80	285	1150	1055	483	411	-	-	-
CJTX-C-18/18	1278	900	60	1250	1207	10,5	11	774	870	95	325	1328	1205	552	480	614,5	20	1229
CJTX-C-20/20	1495	1050	60	1474	1431	13	11	954	1100	122	347	1555	1419	611	611	722,5	20	1545
CJTX-C-22/22	1640	1180	60	1625	1582	13	11	1054	1250	125	350	1700	1570	665	705	795,5	20	1591
CJTX-C-25/25	1800	1300	60	1825	1782	13	11	1174	1450	125	369	1860	1770	775	806	875,5	20	1751
CJTX-C-30/28	2000	1525	60	2134	2091	13	11	1399	1760	118	465	2060	2079	900	942	975,5	20	1951

Supply on request: Vertical impulsion (V) LG-0

PLAN VIEW

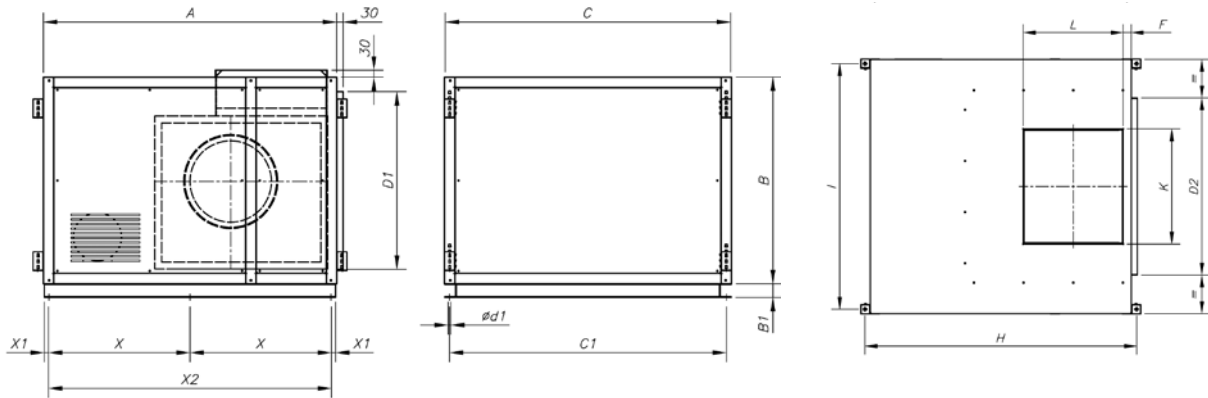

Model	A	B	B1	C	C1	ød	ød1	D1	D2	F	H	I	K	L	X	X1	X2
CJTX-C-7/7	700	480	-	730	695	10,5	9	354	470	165	750	685	238	210	-	-	-
CJTX-C-9/9	785	592	-	759	716	10,5	9	466	490	157	835	714	312	272	-	-	-
CJTX-C-10/10	860	618	-	825	782	10,5	9	492	520	135	910	780	333	300	-	-	-
CJTX-C-12/12	970	680	-	945	902	10,5	9	554	620	183	1020	900	397	355	-	-	-
CJTX-C-15/15	1100	776	-	1100	1057	10,5	9	650	720	197	1150	1055	479	421	-	-	-
CJTX-C-18/18	1278	900	60	1250	1207	10,5	11	774	870	281	1328	1205	550	495	614,5	20	1229
CJTX-C-20/20	1495	1050	60	1474	1431	13	11	954	1100	283	1555	1419	610	611	722,5	20	1545
CJTX-C-22/22	1640	1180	60	1625	1582	13	11	1054	1250	325	1700	1570	666	701	795,5	20	1591
CJTX-C-25/25	1800	1300	60	1825	1782	13	11	1174	1450	367	1860	1770	775	798	875,5	20	1751
CJTX-C-30/28	2000	1525	60	2134	2091	13	11	1399	1760	407	2060	2079	894	947	975,5	20	1951

**Characteristic curves**

Q= Flow rate in m<sup>3</sup>/h, m<sup>3</sup>/s and cfm.

Pe= Static pressure in mmH<sub>2</sub>O, Pa and inwg.

**CJTX-C-7/7**

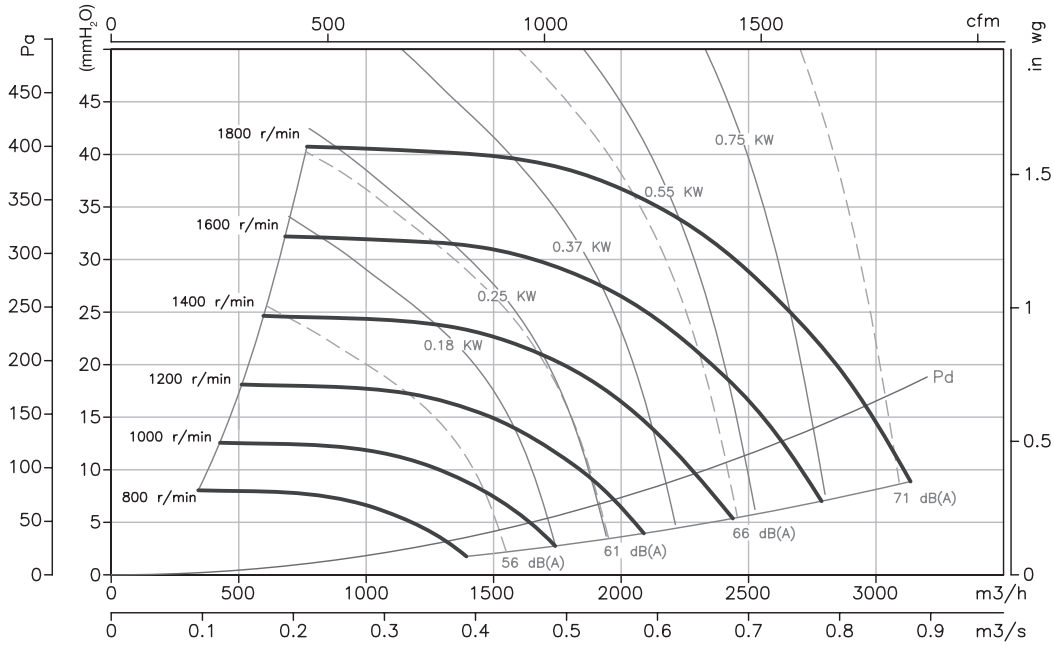

**CJTX-C-9/9**

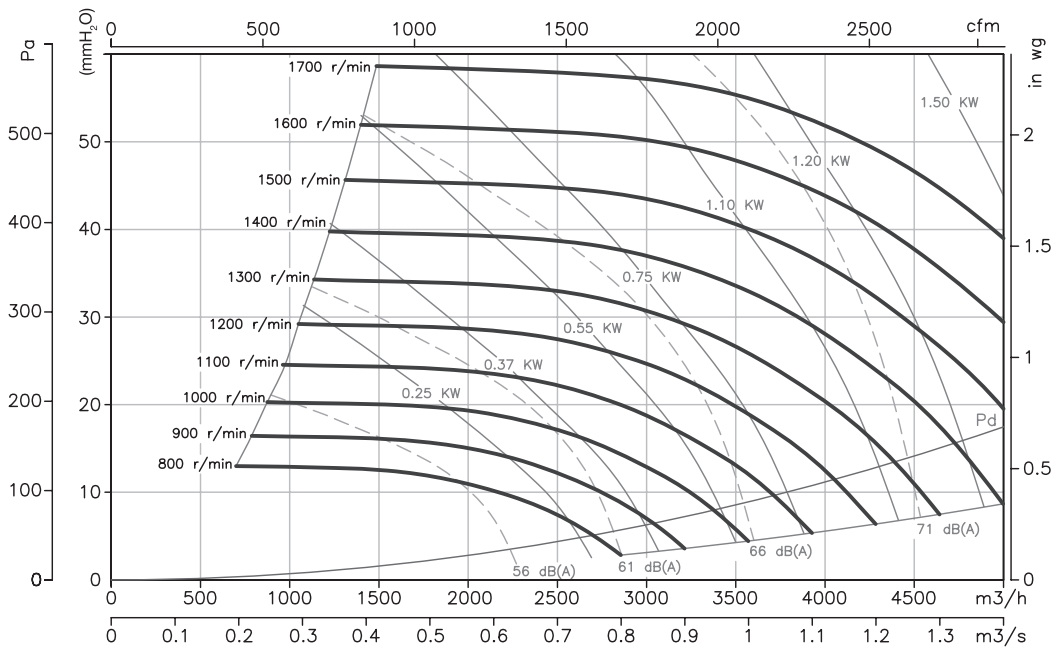

**Characteristic curves**

Q= Flow rate in m<sup>3</sup>/h, m<sup>3</sup>/s and cfm.

Pe= Static pressure in mmH<sub>2</sub>O, Pa and inwg.

**CJTX-C-10/10**

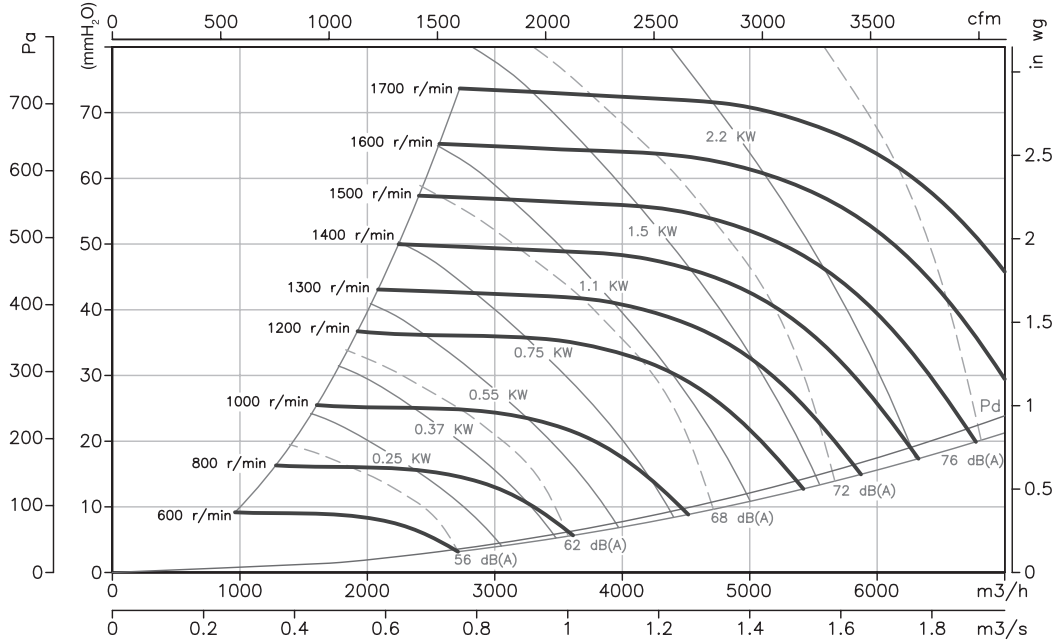

**CJTX-C-12/12**

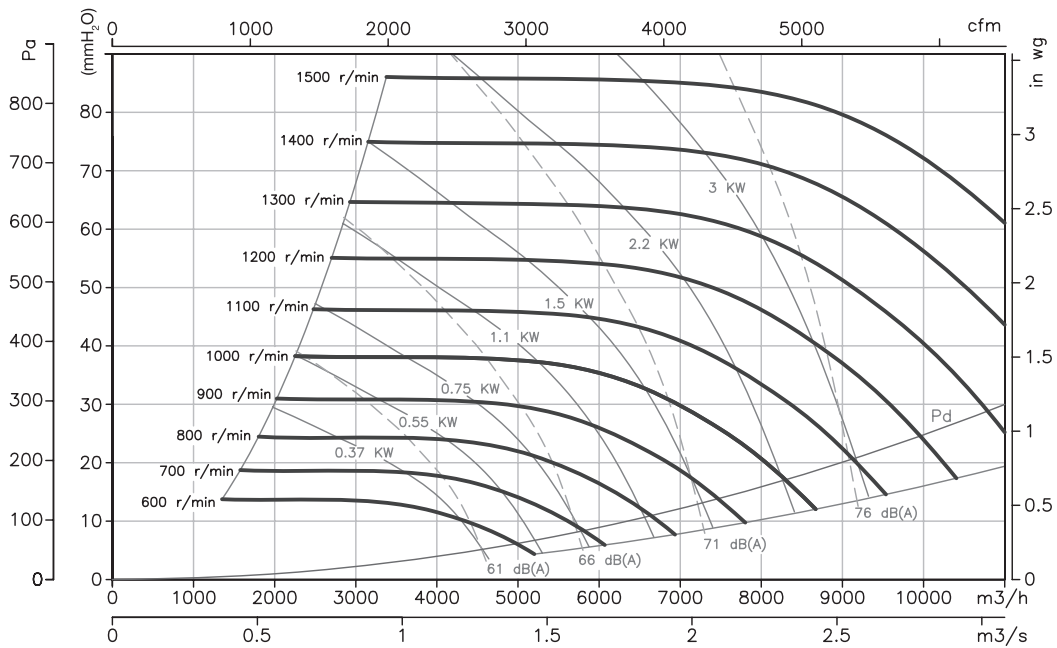

**Characteristic curves**

Q= Flow rate in m<sup>3</sup>/h, m<sup>3</sup>/s and cfm.

Pe= Static pressure in mmH<sub>2</sub>O, Pa and inwg.

**CJTX-C-15/15**

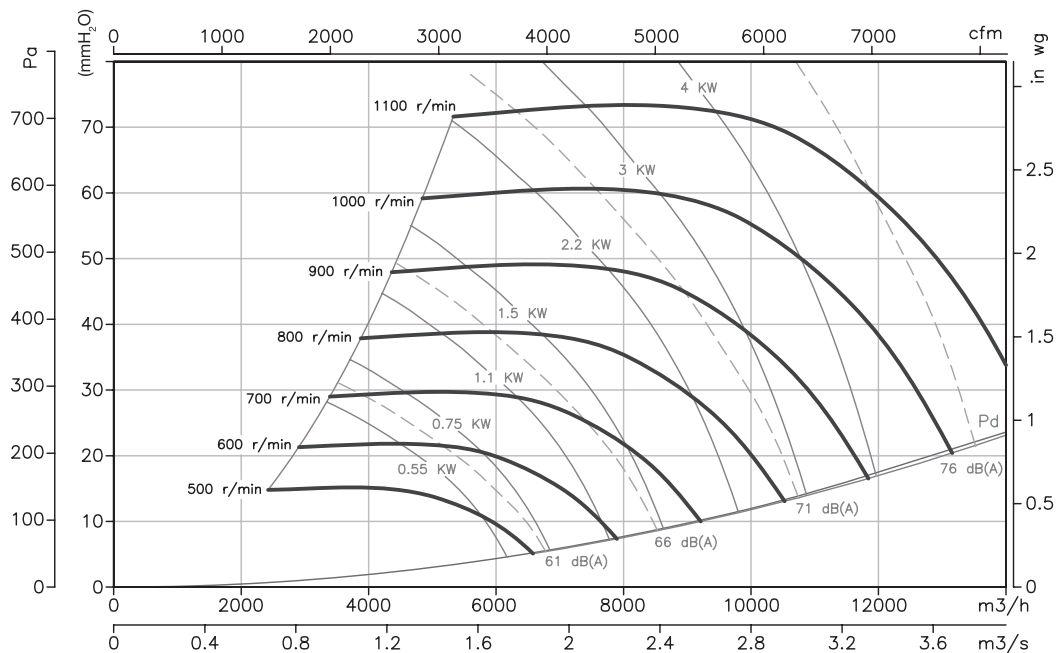

**CJTX-C-18/18**

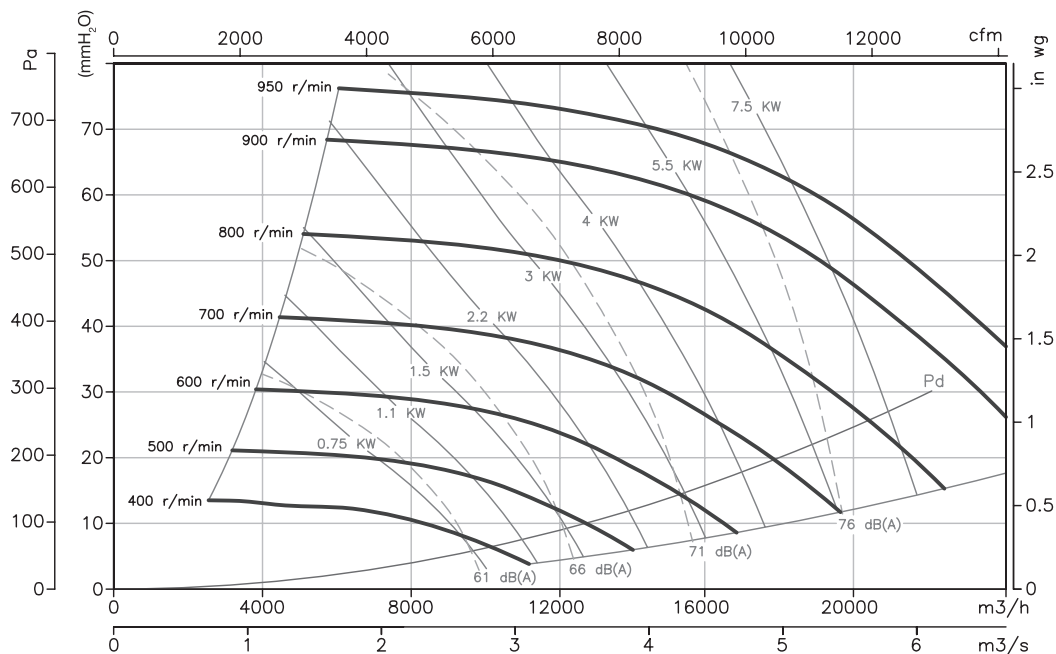

**Characteristic curves**

Q= Flow rate in m<sup>3</sup>/h, m<sup>3</sup>/s and cfm.

Pe= Static pressure in mmH<sub>2</sub>O, Pa and inwg.

**CJTX-C-20/20**

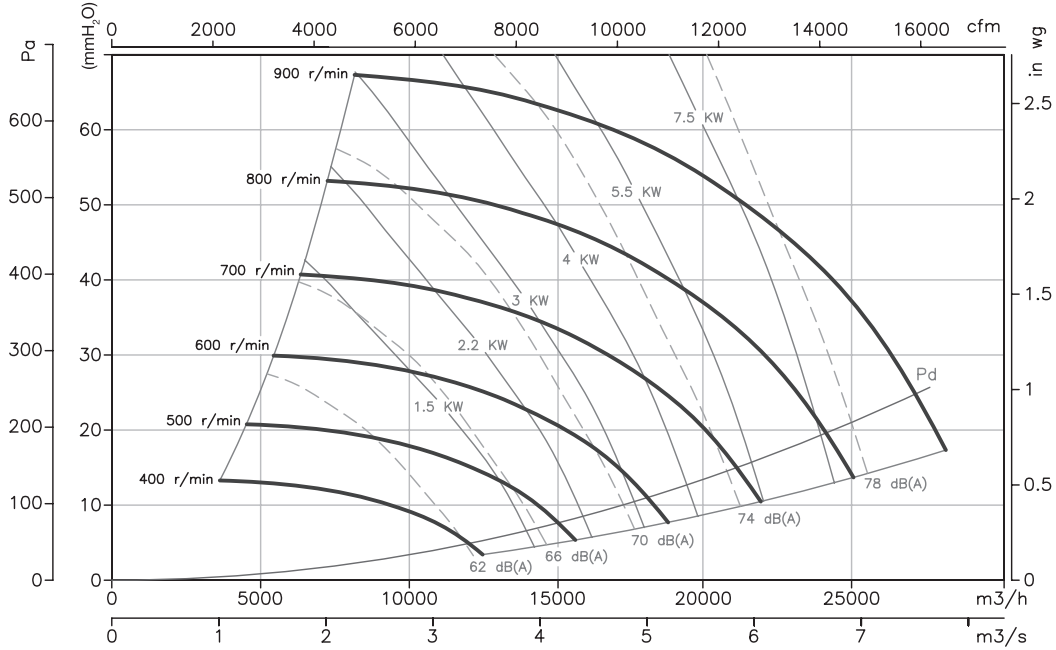

**CJTX-C-22/22**

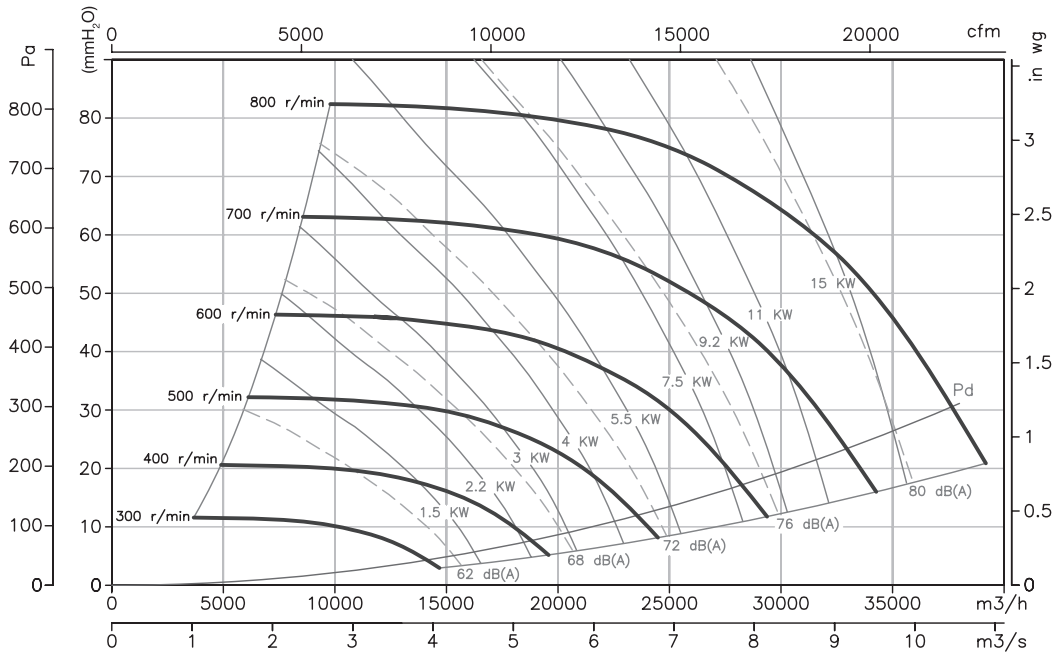

**Characteristic curves**

Q= Flow rate in m<sup>3</sup>/h, m<sup>3</sup>/s and cfm.

Pe= Static pressure in mmH<sub>2</sub>O, Pa and inwg.

**CJTX-C-25/25**

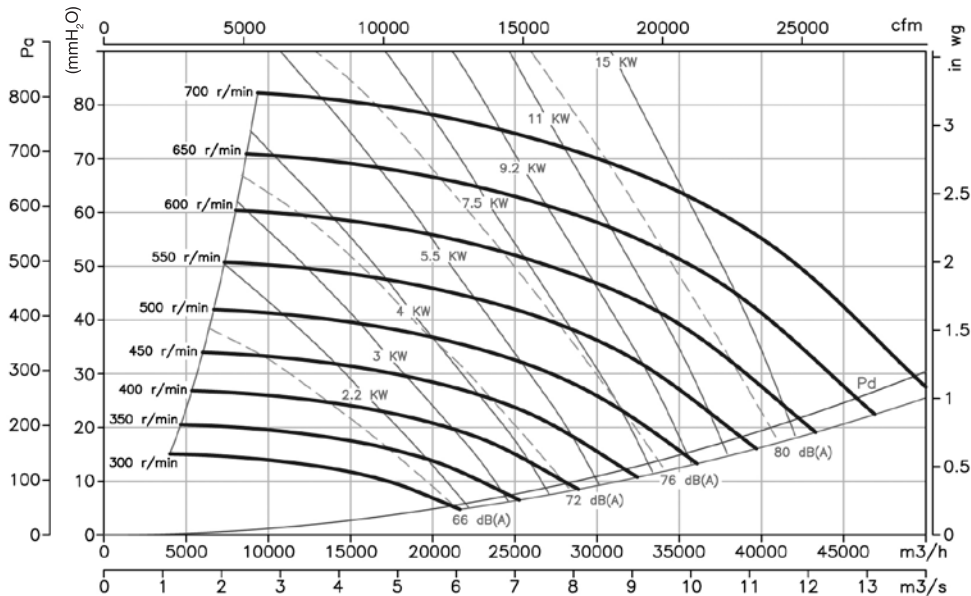

**CJTX-C-30/28**

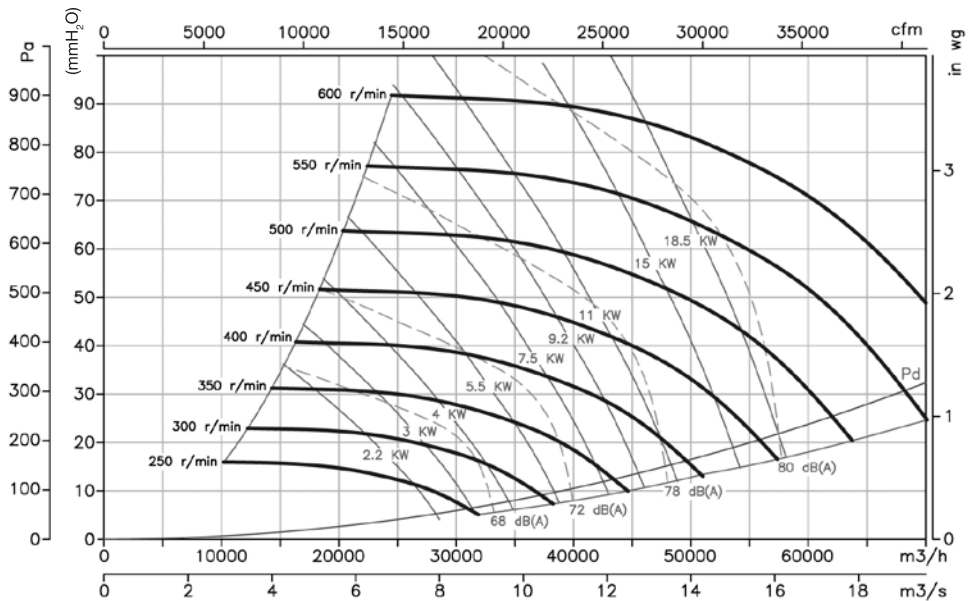

**Accessories**



# CJSX



with motor outside  
the air flow

## 400 °C/2h, belt-driven extractor fan units with single inlet fans

400 °C/2h extractor fan units, with motor mounted outside the airflow path, for operation outside the fire risk zone

### Fan:

- Galvanised sheet steel structure.
- Forward-curved impeller made of galvanised sheet steel.
- Approved in accordance with standard EN 12101-3, with certificate no.: 0370-CPR-0503

### Motor:

- Class F motors with ball bearings and IP55 protection.
- Multi voltage motor, special design valid for 220/380V 60Hz, 254/440V 60Hz, 265/460V 60Hz, 277/480V 60Hz
- Maximum temperature of air to be carried: S1 continuous operation -20 °C +120 °C, S2 operation 300 °C/2h and 400 °C/2h.

### Finish:

- Anti-corrosive finished galvanised sheet steel.

### On request:

- Extractor fans with 2-speed motors.
- Vertical outlet extractor fans.



## Order code

<b>CJSX</b>	—	<b>22/11</b>	—	<b>3</b>	—	<b>F-400</b>	—	<b>60Hz</b>
↓		↓		↓		↓		
400 °C/2h centrifugal extractor fans with reaction impeller		Impeller size		Motor power (hp)		F-400: 400 °C/2h approved		
						For S2 operation: 300 °C/2h and 400 °C/2h		

## Technical characteristics

**60Hz**

Model	Speed (r/min)	Maximum admissible current (A)		Installed power (kW)	Maximum flow rate (m3/h)	Sound pressure level dB(A)	Approx. weight (kg)
		220-277V	380-480V				
CJSX-12/6-0,75	1000	2.42	1.40	0.55	2600	69	73
CJSX-12/6-1	1100	3.29	1.90	0.75	3100	71	74
CJSX-12/6-1,5	1250	4.49	2.59	1.10	3500	74	77
CJSX-12/6-2	1300	5.98	3.45	1.50	4250	77	80
CJSX-12/6-3	1500	8.31	4.80	2.20	4800	79	85
CJSX-15/7-1	800	3.29	1.90	0.75	4000	67	92
CJSX-15/7-1,5	850	4.49	2.59	1.10	4800	69	95
CJSX-15/7-2	920	5.98	3.45	1.50	5400	72	98
CJSX-15/7-3	1000	8.31	4.80	2.20	6400	75	103
CJSX-15/7-4	1050	11.22	6.48	3.00	7400	77	106
CJSX-18/9-1,5	750	4.49	2.59	1.10	5800	68	111
CJSX-18/9-2	790	5.98	3.45	1.50	6600	70	114
CJSX-18/9-3	800	8.31	4.80	2.20	8200	74	119
CJSX-18/9-4	850	11.22	6.48	3.00	9000	76	122
CJSX-18/9-5,5	920	14.90	8.60	4.00	10500	78	125
CJSX-20/10-2	650	5.98	3.45	1.50	8100	65	203
CJSX-20/10-3	690	8.31	4.80	2.20	10100	68	208
CJSX-20/10-4	750	11.22	6.48	3.00	11500	70	211
CJSX-20/10-5,5	790	14.90	8.60	4.00	13100	73	214
CJSX-20/10-7,5	850		11.10	5.50	15000	75	227
CJSX-22/11-3	580	8.31	4.80	2.20	11200	67	219
CJSX-22/11-4	610	11.22	6.48	3.00	13000	70	222
CJSX-22/11-5,5	650	14.90	8.60	4.00	15000	72	225
CJSX-22/11-7,5	690		11.10	5.50	17000	74	238

### Technical characteristics

Model	Speed (r/min)	Maximum admissible current (A)		Installed power (kW)	Maximum flow rate (m <sup>3</sup> /h)	Sound pressure level dB(A)	Approx. weight (kg)
		220-277V	380-480V				
CJSX-22/11-10	750		14.80	7.50	19000	76	246
CJSX-22/11-12,5	790		17.80	9.20	21000	78	257
CJSX-22/11-15	830		21.50	11.00	22000	79	273
CJSX-22/11-20	910		28.50	15.00	24500	81	292
CJSX-22/11-25	1000		35.00	18.50	26000	83	322
CJSX-25/13-4	520	11.22	6.48	3.00	14000	62	254
CJSX-25/13-5,5	550	14.90	8.60	4.00	17000	65	257
CJSX-25/13-7,5	590		11.10	5.50	19500	67	270
CJSX-25/13-10	620		14.80	7.50	23000	70	278
CJSX-25/13-12,5	650		17.80	9.20	25000	72	289
CJSX-25/13-15	690		21.50	11.00	26500	74	305
CJSX-25/13-20	750		28.50	15.00	29500	75	324
CJSX-25/13-25	810		35.00	18.50	32000	77	354
CJSX-30/14-5,5	400	14.90	8.60	4.00	21000	69	331
CJSX-30/14-7,5	425		11.10	5.50	24000	72	344
CJSX-30/14-10	460		14.80	7.50	27500	74	352
CJSX-30/14-12,5	480		17.80	9.20	30000	76	363
CJSX-30/14-15	500		21.50	11.00	33000	77	379
CJSX-30/14-20	550		28.50	15.00	36500	78	398
CJSX-30/14-25	600		35.00	18.50	38000	81	428

### Dimensions mm

Standard supply horizontal impulsion (H) RD-90

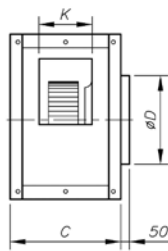
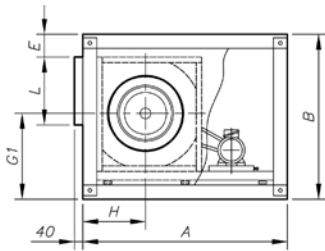

Vertical impulsion on request (V) RD-0

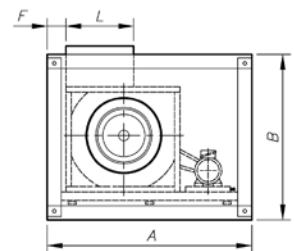
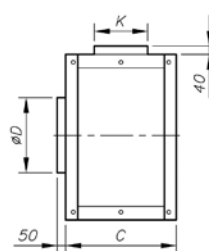

Horizontal impulsion on request (H) LG-90

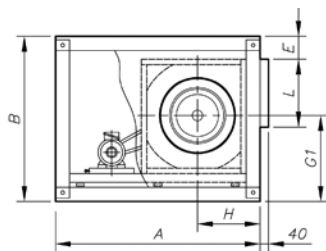
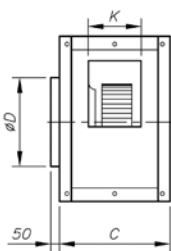

Vertical impulsion on request (V) LG-90

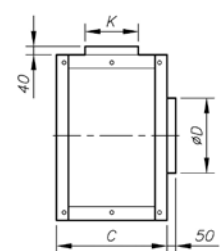
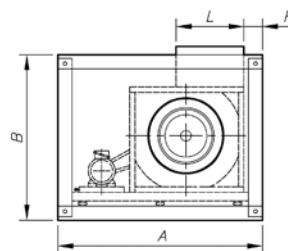

Model	A	B	C	ØD	E	with bench		with bench		with bench		K	
						E	F	G1	G1	H	L		L
CJSX-12/6-H	850	650	540	330	74	-	-	288	-	288	346	-	210
CJSX-12/6-V	850	650	540	330	-	-	30	318	-	328	346	-	210
CJSX-15/7-H	1000	755	600	400	74	-	-	328	-	328	411	-	270
CJSX-15/7-V	1000	755	600	400	-	-	30	378	-	383	411	-	270
CJSX-18/9-H	1200	875	620	480	74	-	-	383	-	388	491	-	305
CJSX-18/9-V	1200	875	620	480	-	-	30	433	-	448	491	-	305
CJSX-20/10-H	1485	1175	730	565	175	120	-	475	530	440	613	605	343
CJSX-20/10-V	1485	1175	730	565	-	-	75	535	-	585	613	-	343
CJSX-22/11-H	1570	1250	760	615	165	110	-	510	565	470	708	700	373
CJSX-22/11-V	1570	1250	760	615	-	-	75	570	-	640	708	-	373
CJSX-25/13-H	1610	1375	820	685	175	120	-	550	605	495	803	795	423
CJSX-25/13-V	1610	1375	820	685	-	-	75	625	-	705	803	-	423
CJSX-30/14-H	1845	1600	855	820	160	95	-	655	710	580	943	935	488
CJSX-30/14-V	1845	1600	855	820	-	-	75	760	-	825	943	-	488



**Characteristic curves**

Q= Flow rate in m<sup>3</sup>/h, m<sup>3</sup>/s and cfm.

Pe= Static pressure in mmH<sub>2</sub>O, Pa and inwg.

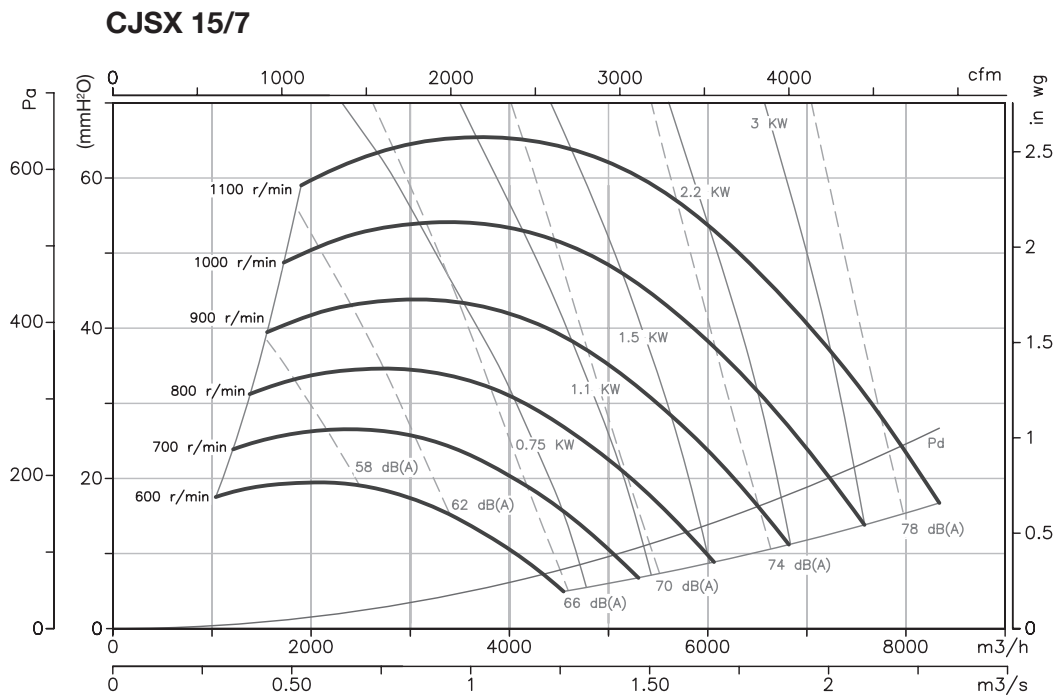
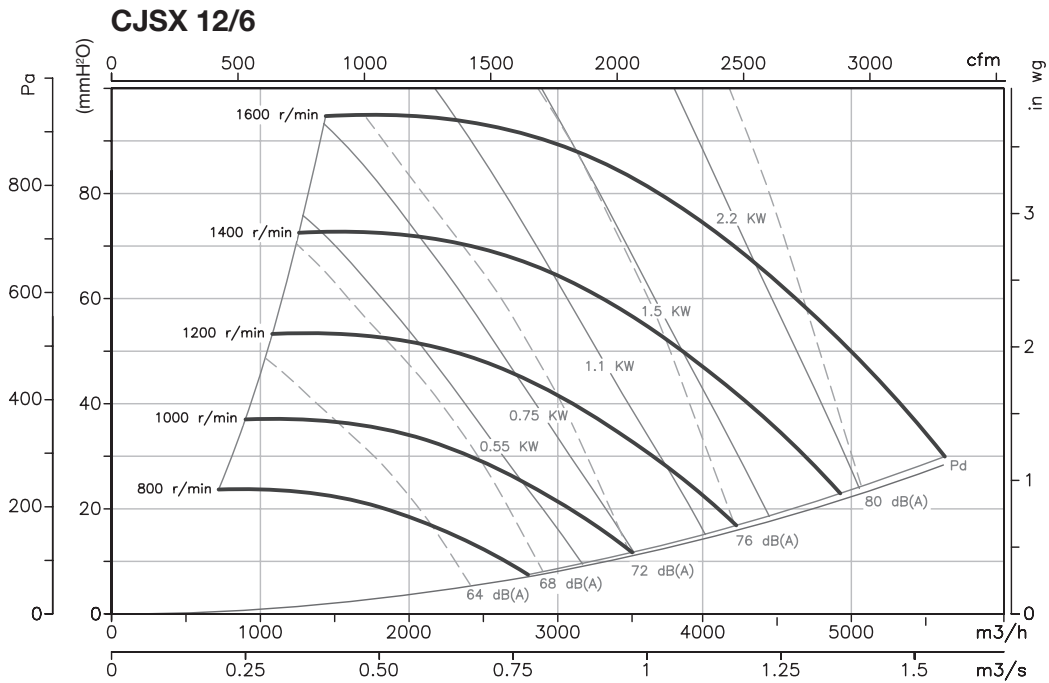

**Characteristic curves**

Q= Flow rate in m<sup>3</sup>/h, m<sup>3</sup>/s and cfm.

Pe= Static pressure in mmH<sub>2</sub>O, Pa and inwg.

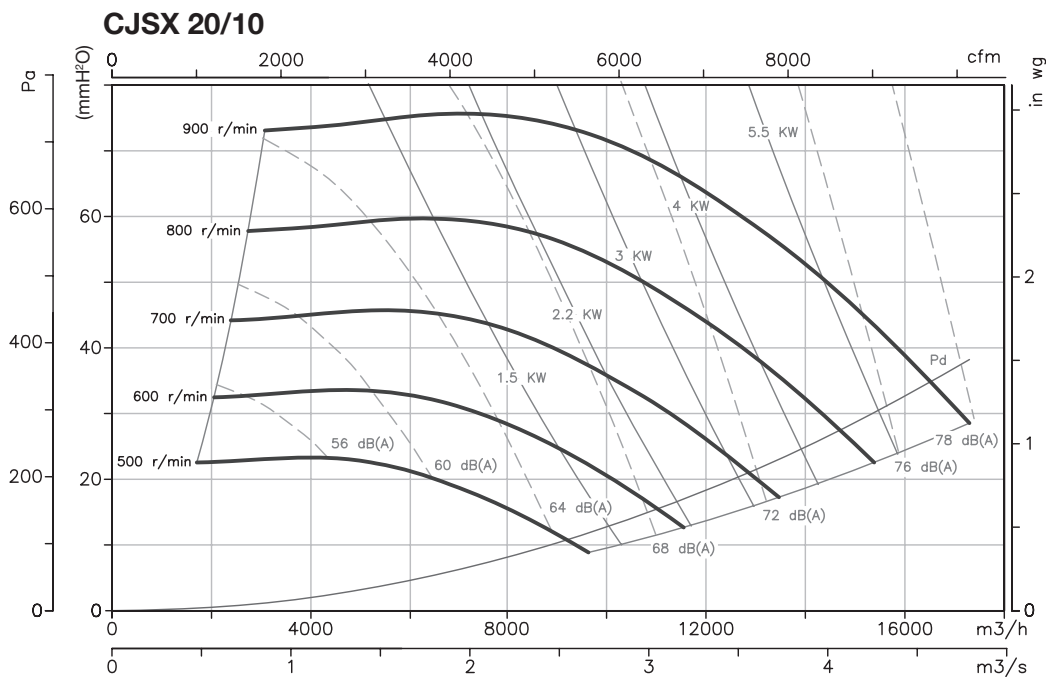
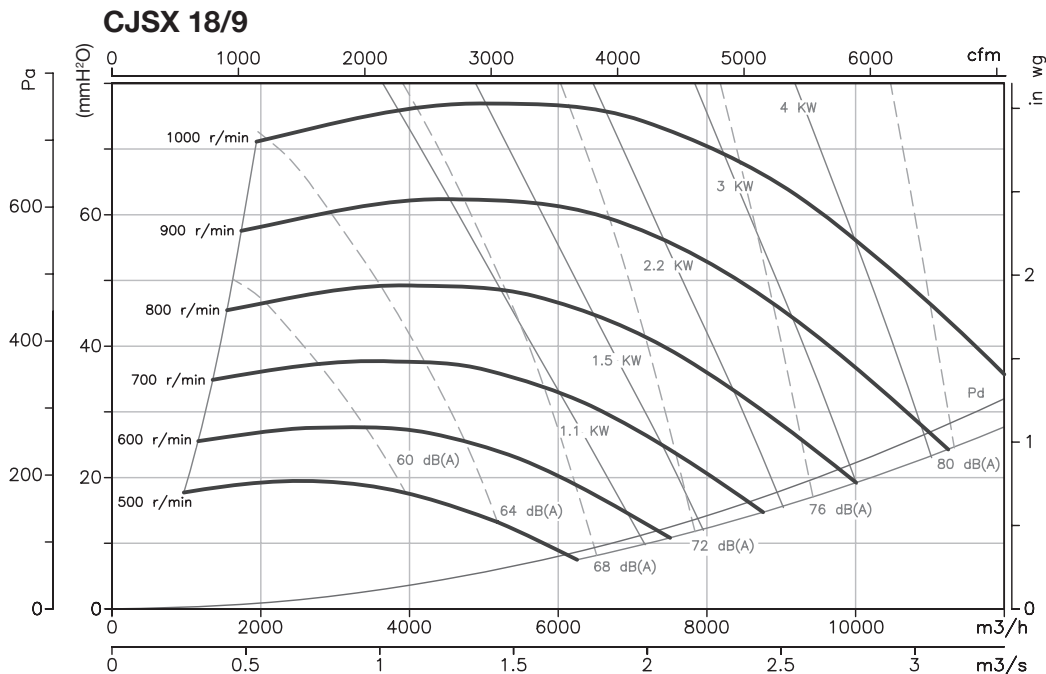

**Characteristic curves**

Q= Flow rate in m<sup>3</sup>/h, m<sup>3</sup>/s and cfm.

Pe= Static pressure in mmH<sub>2</sub>O, Pa and inwg.

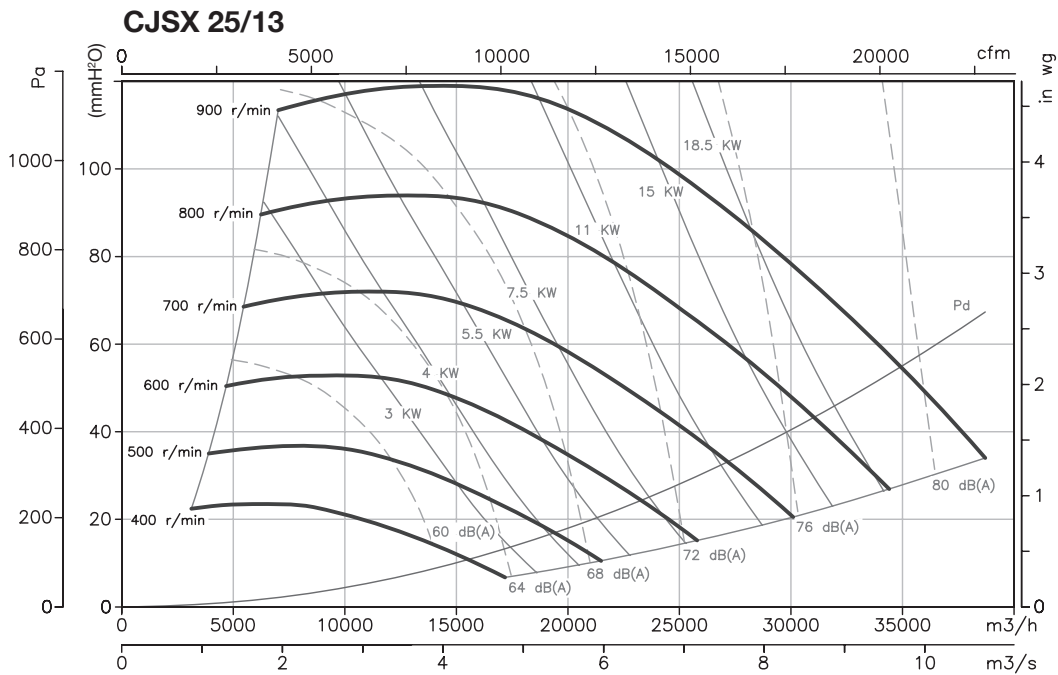
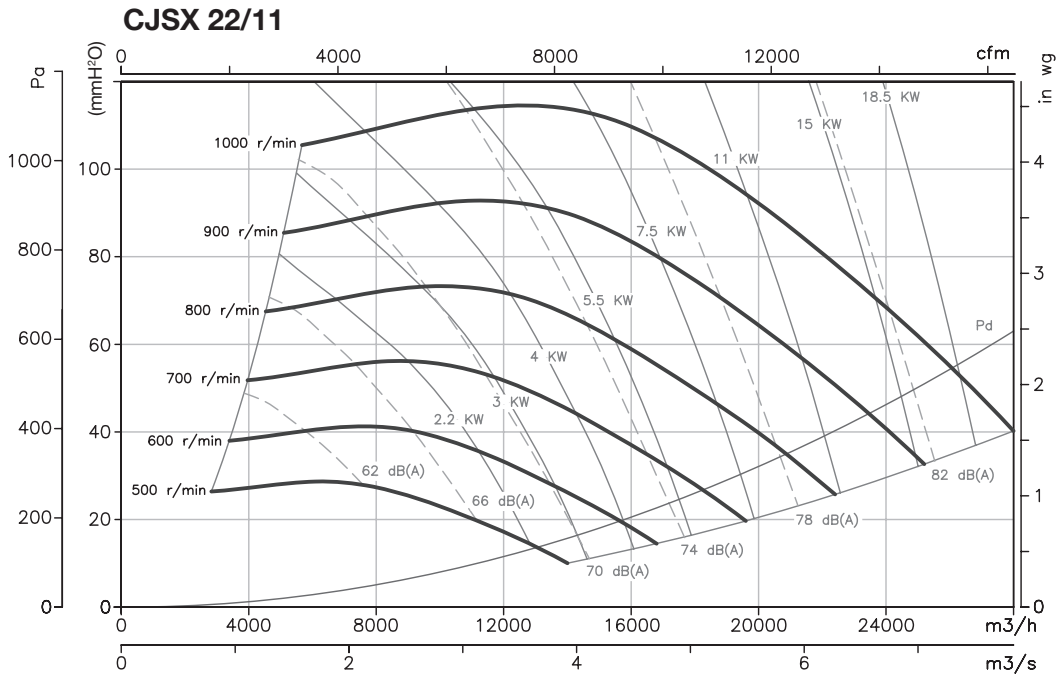

**Characteristic curves**

Q= Flow rate in m<sup>3</sup>/h, m<sup>3</sup>/s and cfm.

Pe= Static pressure in mmH<sub>2</sub>O, Pa and inwg.

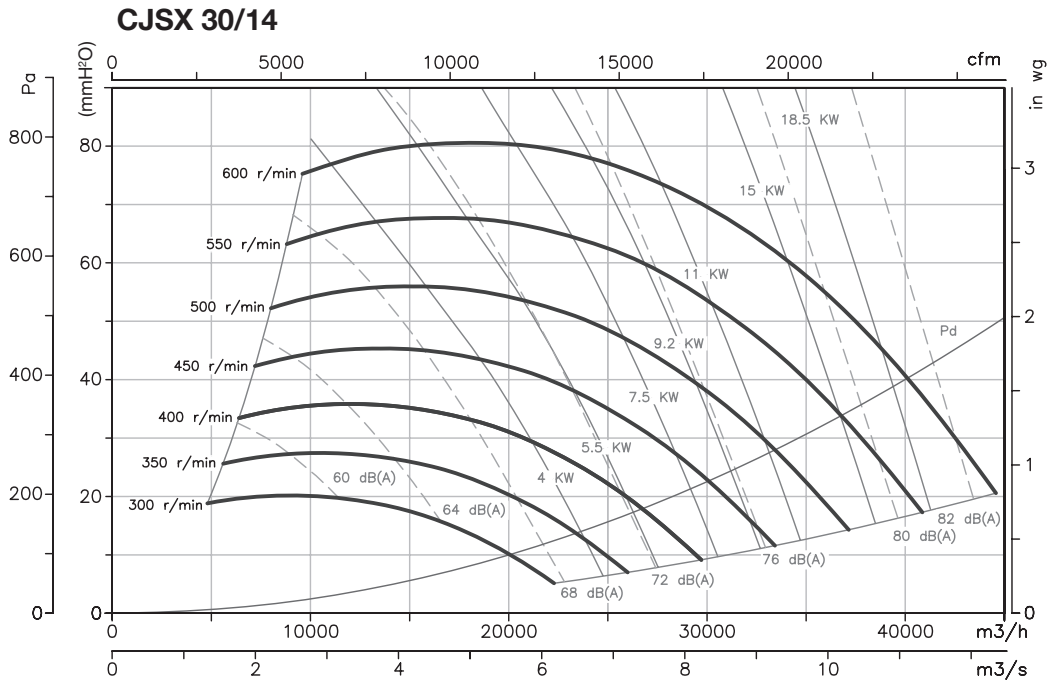

**Accessories**

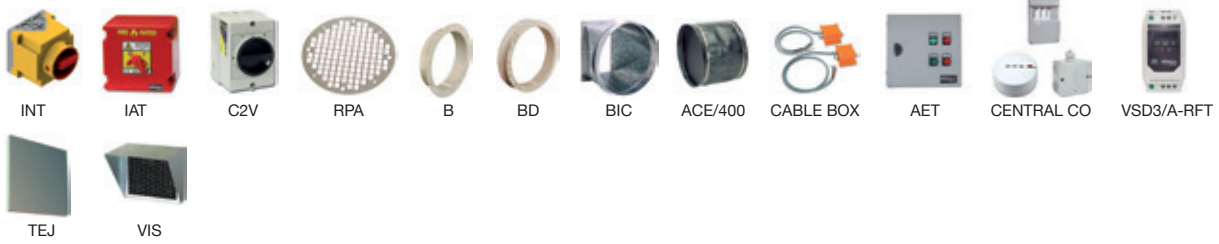

# CSX

## 400 °C/2h, belt-driven centrifugal fans for outdoor operation in the fire risk zone fitted with a reaction impeller



Extremely robust, high performance reaction impeller

400 °C/2h, belt-driven centrifugal extractor fans with reaction impeller fitted with electric motors and a standardised set of pulleys, belts and protectors in accordance with standard ISO-13857

**Fan:**

- Sheet steel casing.
- Impeller with reaction blades made of sheet steel.
- Approved in accordance with standard EN 12101-3:2002/AC:2006 with certification number 0370-CPR-1577.
- Standardised set of pulleys, belts and protectors in accordance with standard ISO-13857.

**Motor:**

- IE3 efficiency motors for powers equal to or greater than 0.75kW except single-phase, 2-speed and 8-pole.
- Class F motors with ball bearings and IP55 protection.
- Multi voltage motor, special design valid for 220/380V 60Hz, 254/440V 60Hz, 265/460V 60Hz, 277/480V 60Hz
- Maximum temperature of air to be carried: -20 °C + 150 °C.

**Finish:**

- Anti-corrosive finish of polyester resin polymerised at 190 °C, previously degreased with phosphate-free nanotechnological treatment.

**On request:**

- Special windings for different voltages.



### Order code

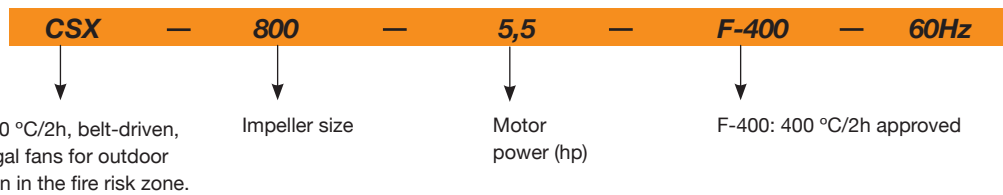

### Technical characteristics

**60Hz**

Model	Speed (r/min)	Maximum admissible current (A)		Installed power (kW)	Maximum flow rate (m3/h)	Approx. weight (kg)
		220-277V	380-480V			
CSX-315-0.5	1650	1.84	1.06	0.37	2700	56
CSX-315-0.75	1880	2.35	1.35	0.55	3075	58
CSX-315-1	2095	3.13	1.80	0.75	3430	57
CSX-315-1.5	2375	4.35	2.50	1.10	3885	62
CSX-315-2	2655	5.83	3.35	1.50	4345	63
CSX-315-3	3000	7.60	4.37	2.20	4910	75
CSX-315-4	3380	10.35	5.95	3.00	5530	77
CSX-355-0.5	1385	1.84	1.06	0.37	3235	64
CSX-355-0.75	1580	2.43	1.40	0.55	3685	65
CSX-355-1	1765	3.13	1.80	0.75	4120	65
CSX-355-1.5	2010	4.35	2.50	1.10	4690	70
CSX-355-2	2225	5.83	3.35	1.50	5190	71
CSX-355-3	2530	7.60	4.37	2.20	5905	82
CSX-355-4	2860	10.35	5.95	3.00	6675	84
CSX-355-5.5	3100	13.22	7.60	4.00	7235	94
CSX-400-0.75	1320	2.35	1.35	0.55	4375	81
CSX-400-1	1465	3.30	1.90	0.75	4855	84
CSX-400-1.5	1665	4.50	2.59	1.10	5515	86
CSX-400-2	1845	5.83	3.35	1.50	6110	93
CSX-400-3	2100	7.60	4.37	2.20	6955	101

### Technical characteristics

Model	Speed (r/min)	Maximum admissible current (A)		Installed power (kW)	Maximum flow rate (m <sup>3</sup> /h)	Approx. weight (kg)
		220-277V	380-480V			
CSX-400-4	2370	10.35	5.95	3.00	7850	99
CSX-400-5.5	2610	13.22	7.60	4.00	8645	109
CSX-450-0.75	1095	2.43	1.40	0.55	5045	101
CSX-450-1	1220	3.30	1.90	0.75	5620	106
CSX-450-1.5	1390	4.50	2.59	1.10	6405	106
CSX-450-2	1540	6.00	3.45	1.50	7095	113
CSX-450-3	1750	8.35	4.80	2.20	8065	121
CSX-450-4	1980	10.35	5.95	3.00	9120	119
CSX-450-5.5	2180	13.22	7.60	4.00	10045	129
CSX-450-7.5	2420	-	10.50	5.50	11150	151
CSX-450-10	2670	-	13.90	7.50	12300	154
CSX-500-1	1005	3.30	1.90	0.75	6465	132
CSX-500-1.5	1140	4.50	2.59	1.10	7330	132
CSX-500-2	1270	6.00	3.45	1.50	8165	138
CSX-500-3	1445	8.35	4.80	2.20	9290	147
CSX-500-4	1635	11.27	6.48	3.00	10510	149
CSX-500-5.5	1800	13.91	8.00	4.00	11570	158
CSX-500-7.5	2000	-	11.10	5.50	12855	176
CSX-500-10	2220	-	13.90	7.50	14270	179
CSX-500-15	2300	-	20.50	11.00	14785	204
CSX-560-2	1035	6.00	3.45	1.50	9885	189
CSX-560-3	1185	8.35	4.80	2.20	11360	191
CSX-560-4	1340	11.27	6.48	3.00	12880	194
CSX-560-5.5	1475	13.91	8.00	4.00	14210	203
CSX-560-7.5	1640	-	11.10	5.50	15830	221
CSX-560-10	1815	-	14.80	7.50	17555	224
CSX-560-15	2065	-	20.50	11.00	20010	249
CSX-630-3	1010	8.35	4.80	2.20	12120	216
CSX-630-4	1140	11.27	6.48	3.00	13680	218
CSX-630-5.5	1255	13.91	8.00	4.00	15060	227
CSX-630-7.5	1395	-	11.10	5.50	16740	245
CSX-630-10	1550	-	14.80	7.50	18600	248
CSX-630-15	1760	-	22.00	11.00	21120	273
CSX-630-20	1900	-	29.00	15	22800	303
CSX-710-4	960	11.27	6.48	3.00	17065	260
CSX-710-5.5	1060	13.91	8.00	4.00	18845	269
CSX-710-7.5	1180	-	11.10	5.50	20980	287
CSX-710-10	1305	-	14.80	7.50	23200	289
CSX-710-15	1485	-	22.00	11.00	26400	315
CSX-710-20	1670	-	29.00	15.00	29690	345
CSX-710-25	1750	-	36.50	18.50	31110	363
CSX-800-4	765	11.27	6.48	3.00	19975	306
CSX-800-5.5	845	13.91	8.00	4.00	22065	315
CSX-800-7.5	940	-	11.10	5.50	24545	333
CSX-800-10	1040	-	14.80	7.50	27155	336
CSX-800-15	1185	-	22.00	11.00	30940	361
CSX-800-20	1330	-	29.00	15.00	34730	391
CSX-800-25	1420	-	36.50	18.50	37080	409
CSX-900-4	640	11.27	6.48	3.00	21200	385
CSX-900-5.5	705	13.91	8.00	4.00	23355	394
CSX-900-7.5	785	-	11.10	5.50	26005	412
CSX-900-10	870	-	14.80	7.50	28820	415
CSX-900-15	990	-	22.00	11.00	32795	440
CSX-900-20	1100	-	29.00	15.00	36440	470
CSX-900-25	1150	-	36.50	18.50	38095	488
CSX-900-30	1200	-	42.00	22.00	39750	522
CSX-1000-5.5	575	13.91	8.00	4.00	25555	487
CSX-1000-7.5	645	-	11.10	5.50	28665	479
CSX-1000-10	715	-	14.80	7.50	31780	482
CSX-1000-15	815	-	22.00	11.00	36220	507
CSX-1000-20	915	-	29.00	15.00	40665	537
CSX-1000-25	980	-	36.50	18.50	43555	555
CSX-1000-30	1040	-	42.00	22.00	46220	589
CSX-1000-40	1120	-	59.00	30.00	49780	619

Dimensions mm

Standard supply RD-90

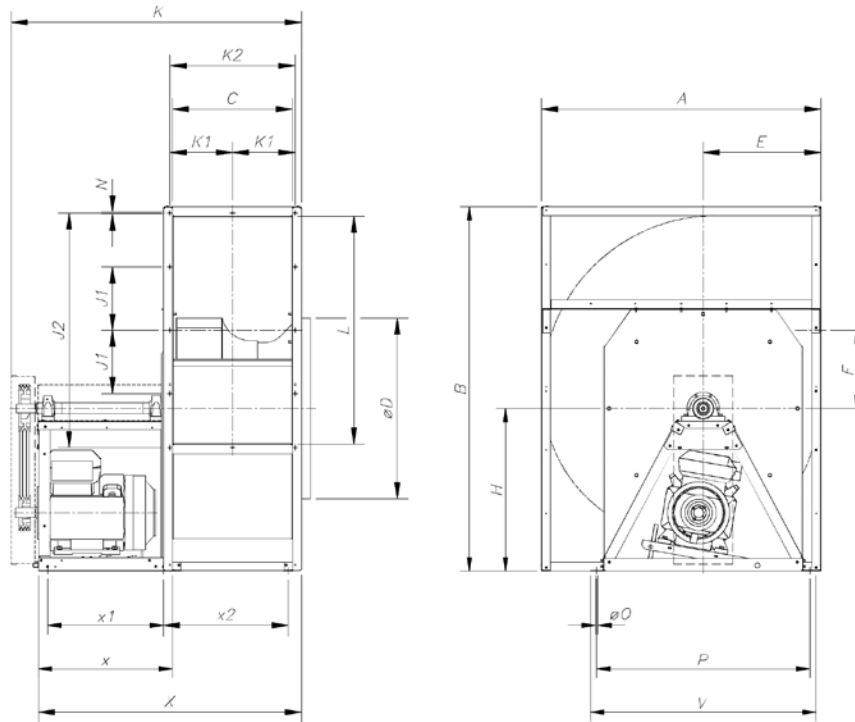

	A	B	C	L	K2	K1	J2	J1	N	øD	H	E	F	K	X	ø0	P	V	x1	x2	x
CSX-315	522	771.5	223	404	253	126.5	434	-	13x9	313	400	236	139.5	769	679	12	454	504	315	264	415
CSX-355	582.5	869.5	247	453	277	138.5	483	-	13x9	353	450	261	158	793	703	12	496	546	315	288	415
CSX-400	651	963	274	507	304	152	537	-	13x9	398	500	290	179.5	820	730	12	542	592	315	315	415
CSX-450	727.5	1067	308	569	338	169	599	-	13x9	448	550	322	202.5	959	829	12	595	645	380	349	480
CSX-500	801	1180	344	638	374	187	658	-	13x9	498	600	352	221	1005	875	12	654	704	380	380	480
CSX-560	892.5	1295	383	715	413	206.5	745	-	13x9	558	650	390	247.5	1202	1064	12	715	765	515	424	630
CSX-630	998.5	1489.5	432	801	462	231	831	-	13x9	628	769	434	280	1251	1113	12	780	830	515	473	630
CSX-710	1117	1547	479	902	508	254	928	200	13x9	708	730	481.5	316	1298	1160	14	890	930	515	520	630
CSX-800	1250	1665.5	533	1010	563	283.5	1037	250	13x9	798	762	535	358.5	1362	1219	14	980	1050	515	574.5	630
CSX-900	1408	1525	595	1130	625	312.5	1160	300	13x9	898	850	604	407	1424	1281	14	1080	1150	515	636.5	630
CSX-1000	1546	2016	663	1260	693	346.5	1297	350	13x9	998	900	651	433	1600	1456	14	1180	1250	642	690	742

**Characteristic curves**

Q= Flow rate in m<sup>3</sup>/h, m<sup>3</sup>/s and cfm.

Pe= Static pressure in mmH<sub>2</sub>O, Pa and inwg.

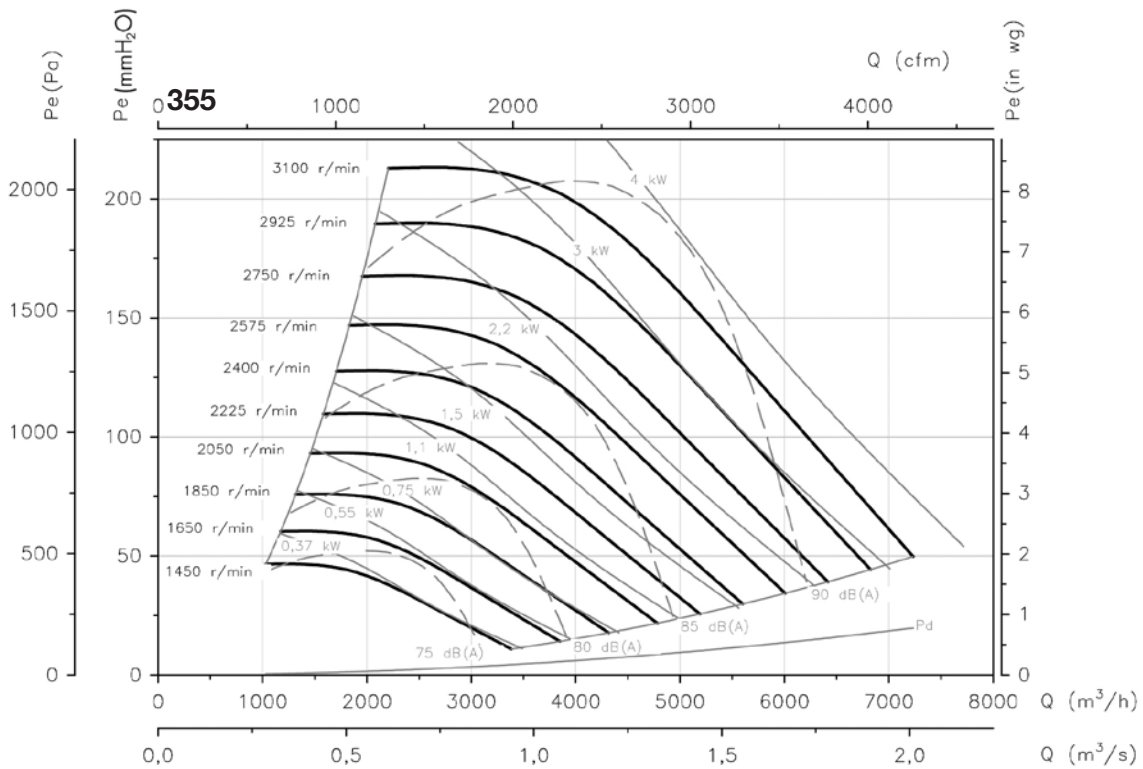
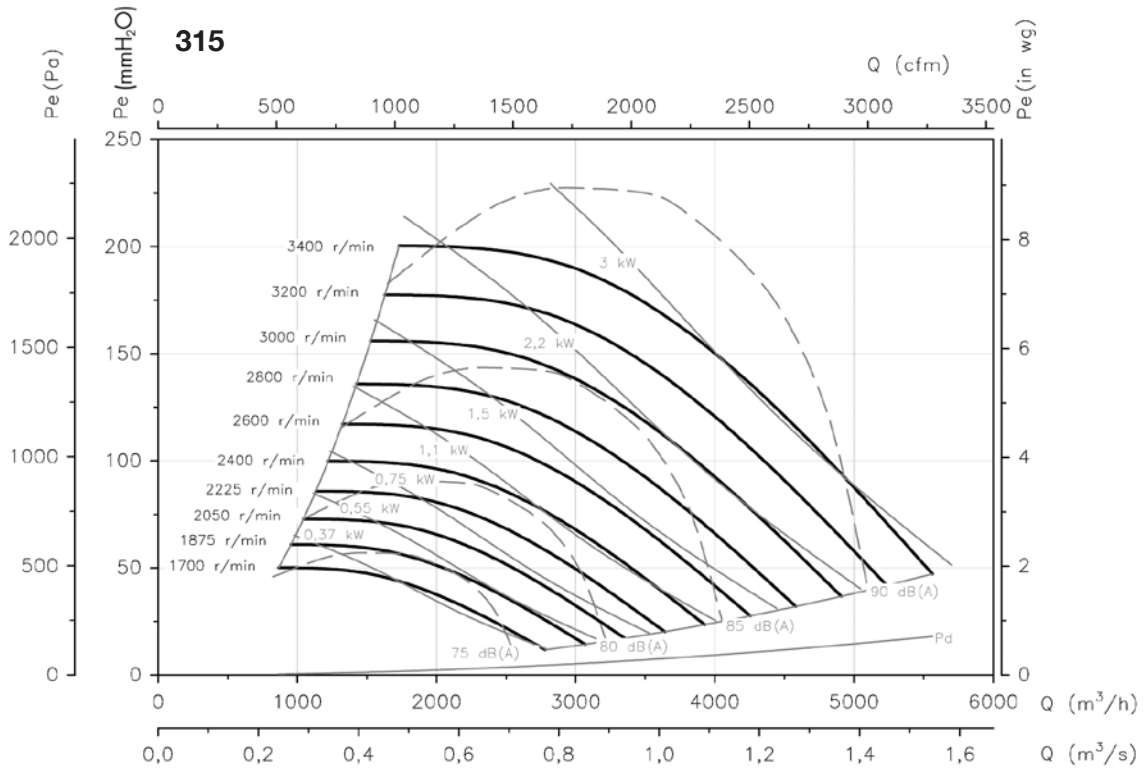



**Characteristic curves**

Q= Flow rate in m<sup>3</sup>/h, m<sup>3</sup>/s and cfm.

Pe= Static pressure in mmH<sub>2</sub>O, Pa and inwg.

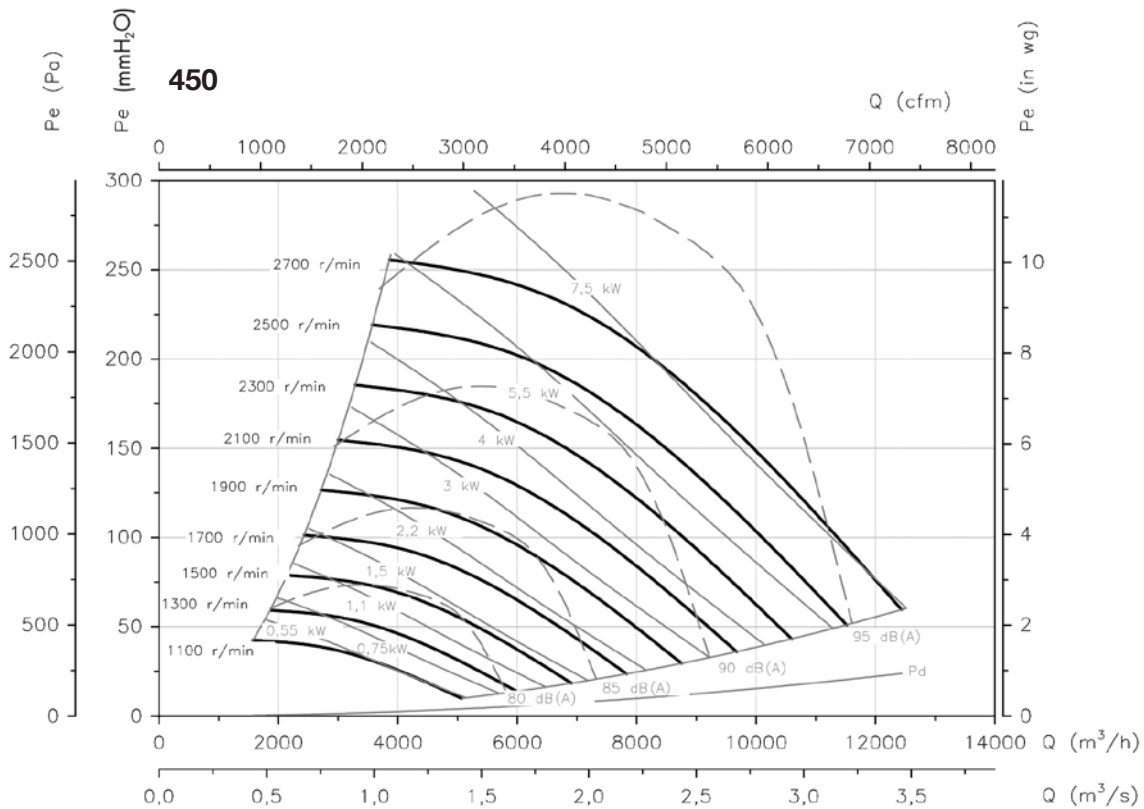
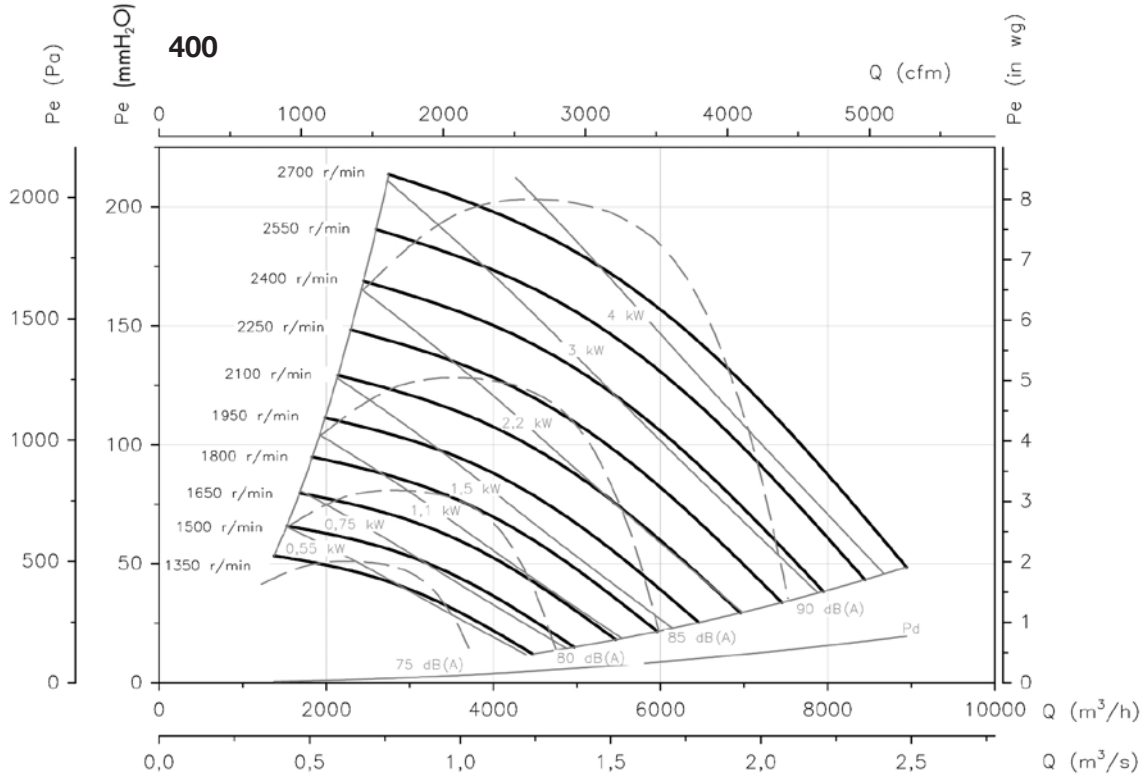

**Characteristic curves**

Q= Flow rate in m<sup>3</sup>/h, m<sup>3</sup>/s and cfm.

Pe= Static pressure in mmH<sub>2</sub>O, Pa and inwg.

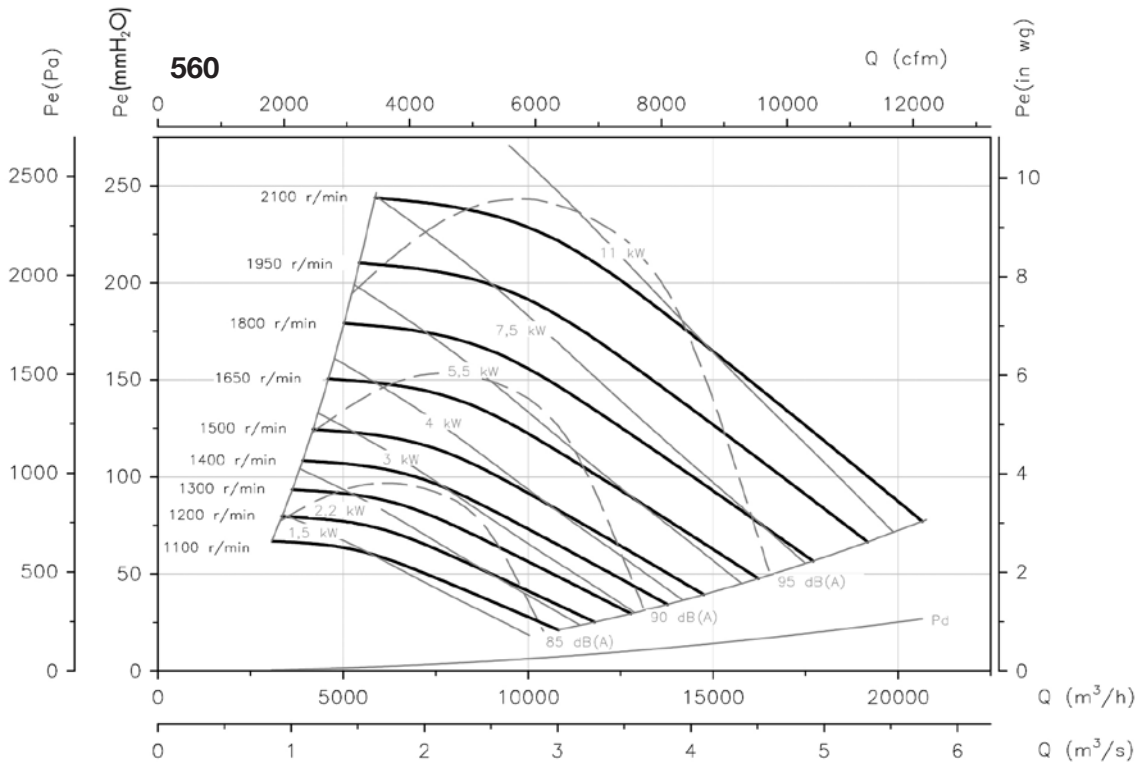
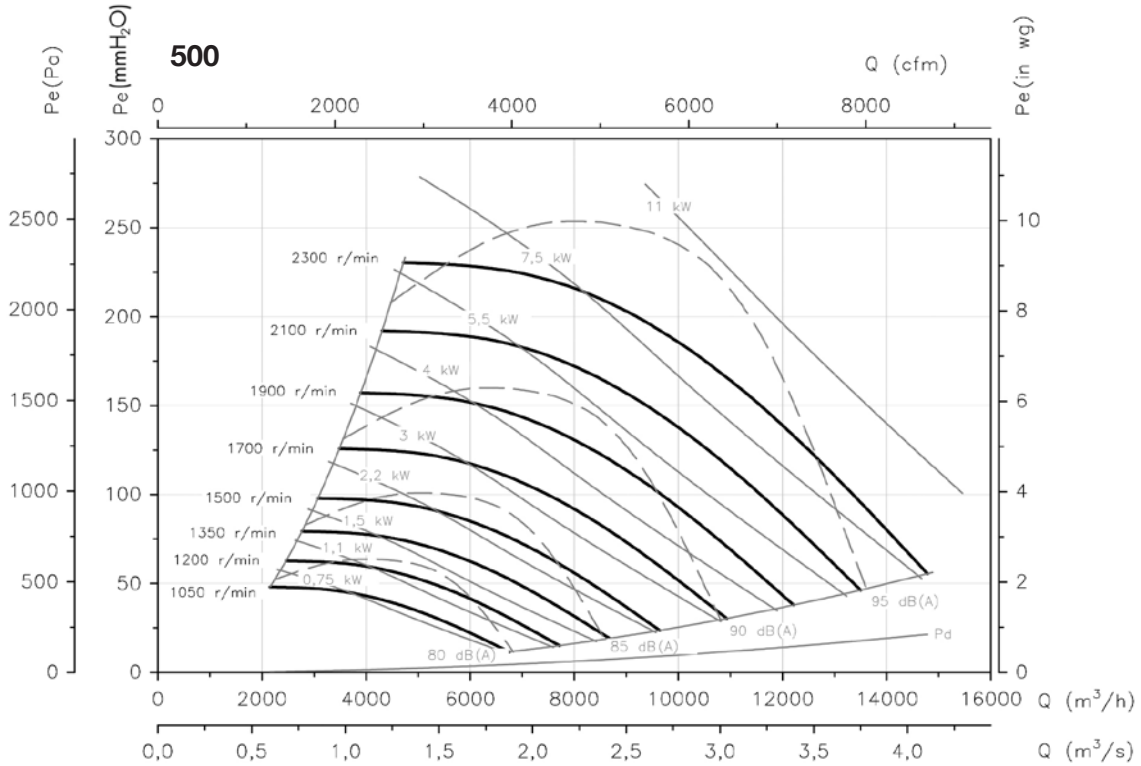

**Characteristic curves**

Q= Flow rate in m<sup>3</sup>/h, m<sup>3</sup>/s and cfm.

Pe= Static pressure in mmH<sub>2</sub>O, Pa and inwg.

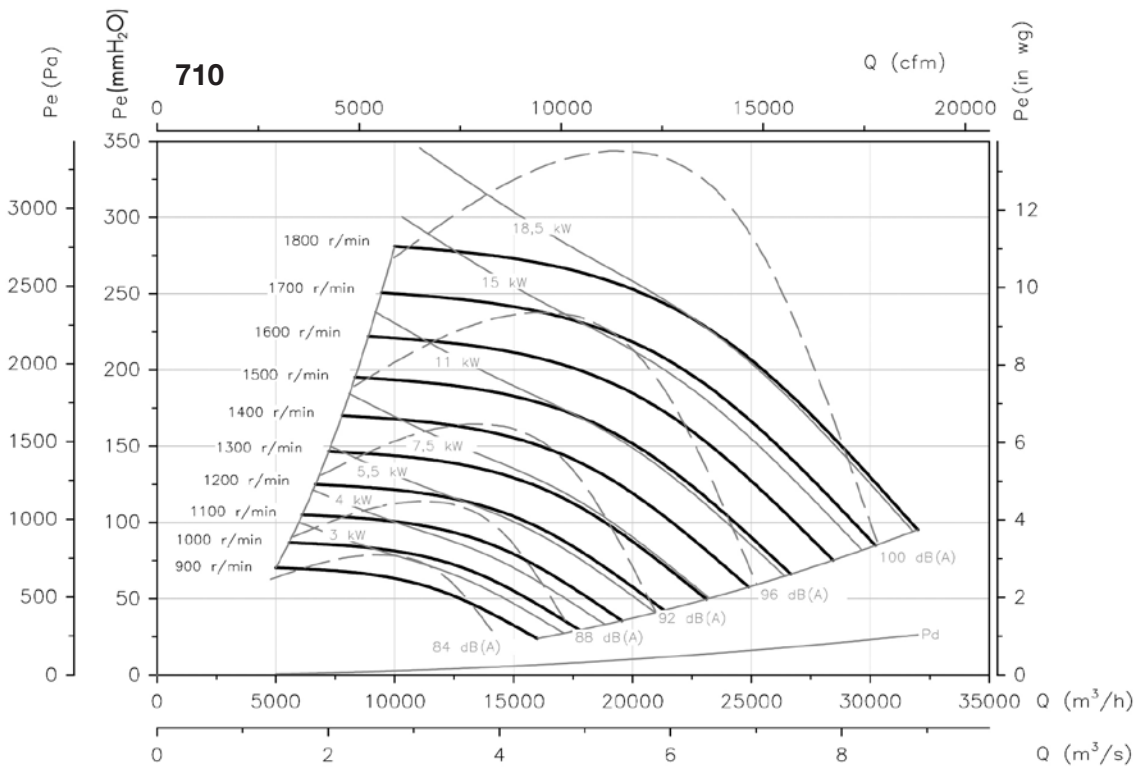
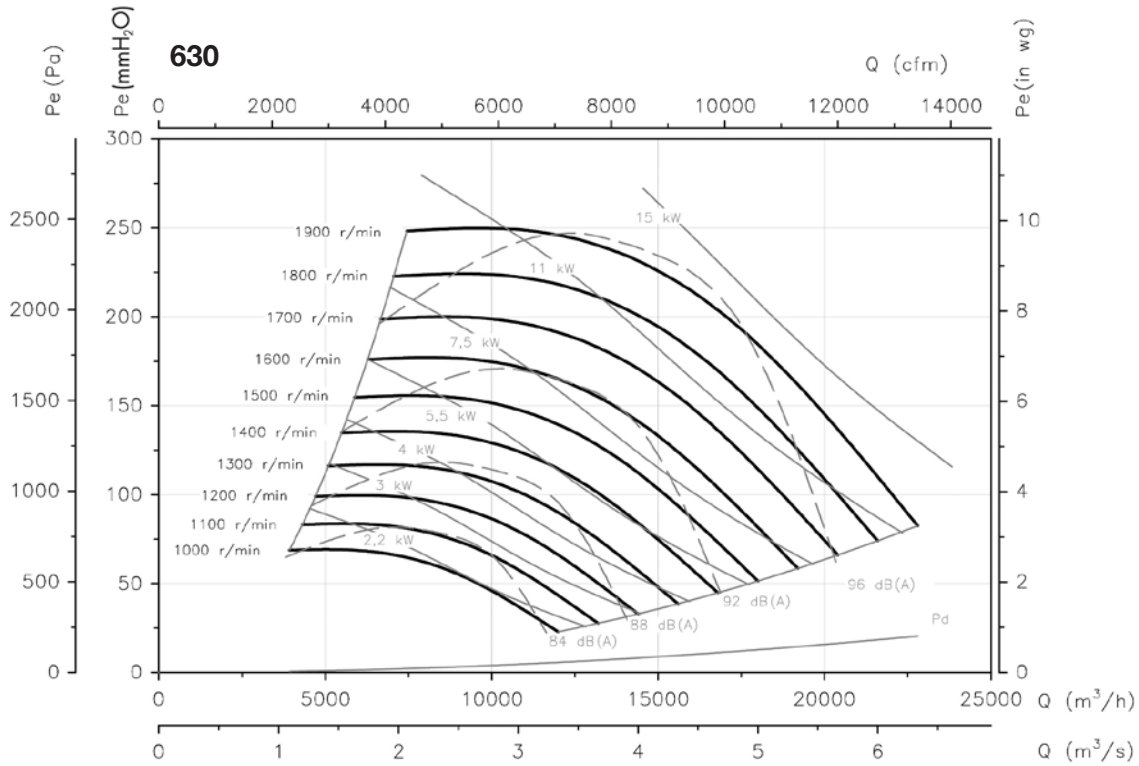

**Characteristic curves**

Q= Flow rate in m<sup>3</sup>/h, m<sup>3</sup>/s and cfm.

Pe= Static pressure in mmH<sub>2</sub>O, Pa and inwg.

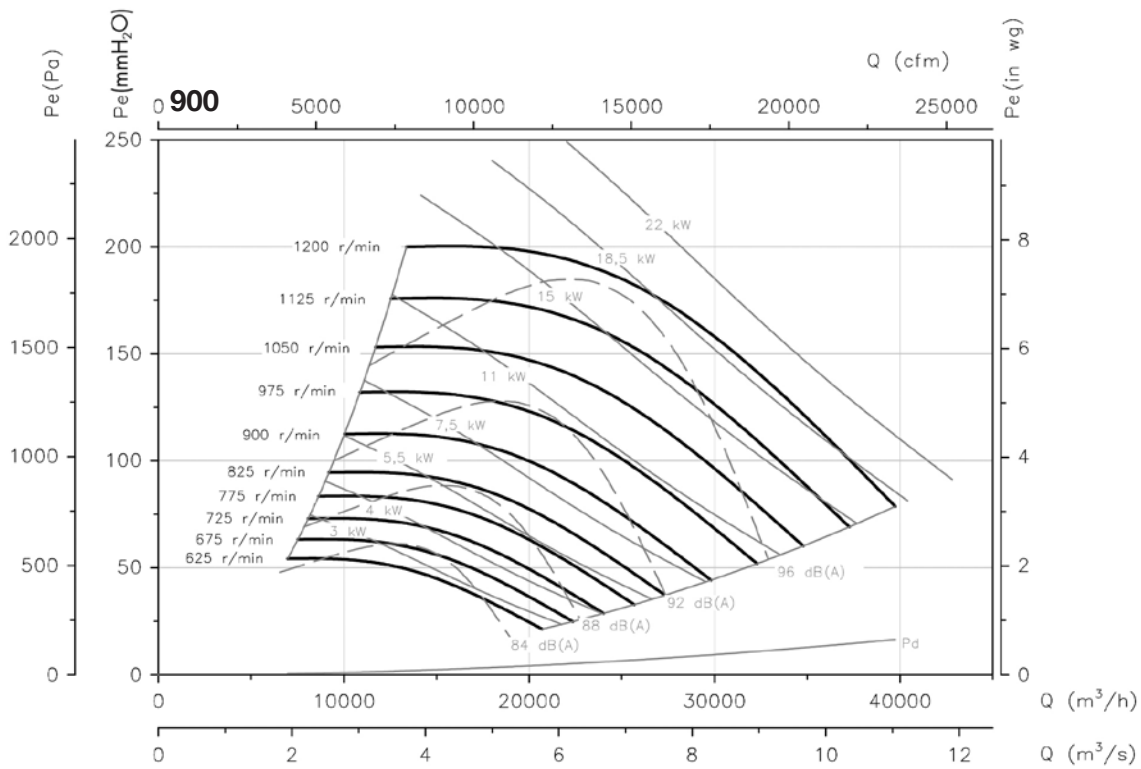
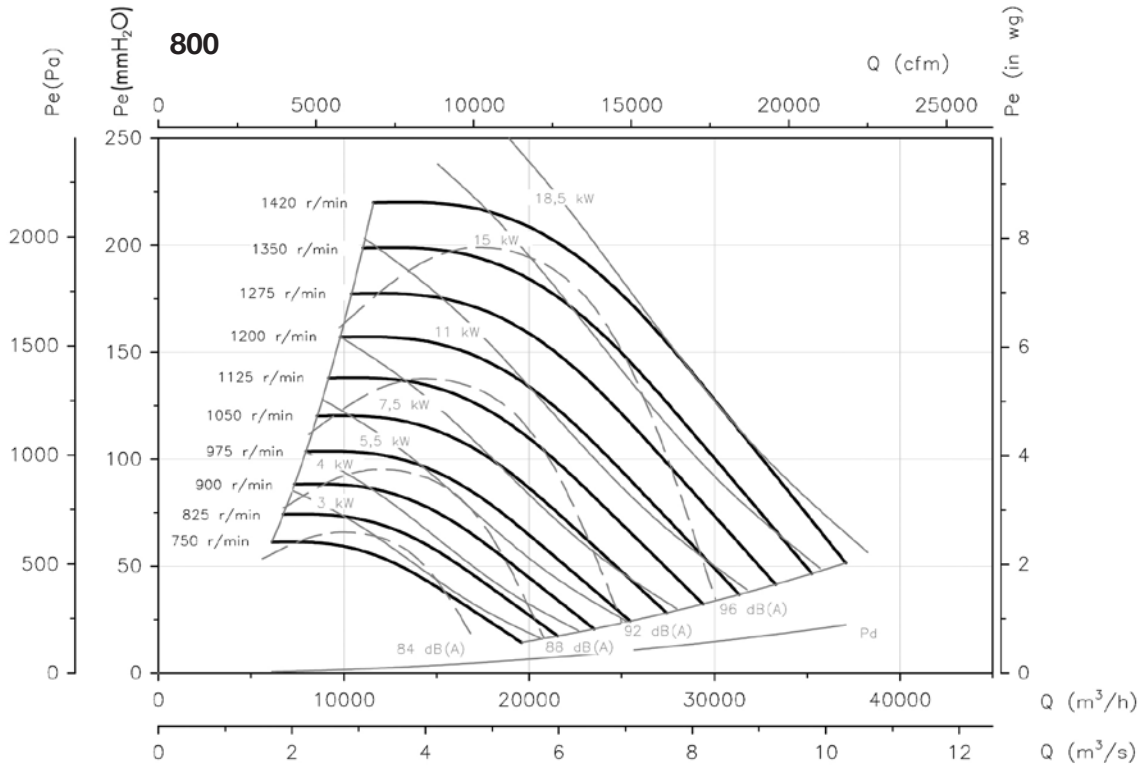

**Characteristic curves**

Q= Flow rate in m<sup>3</sup>/h, m<sup>3</sup>/s and cfm.

Pe= Static pressure in mmH<sub>2</sub>O, Pa and inwg.

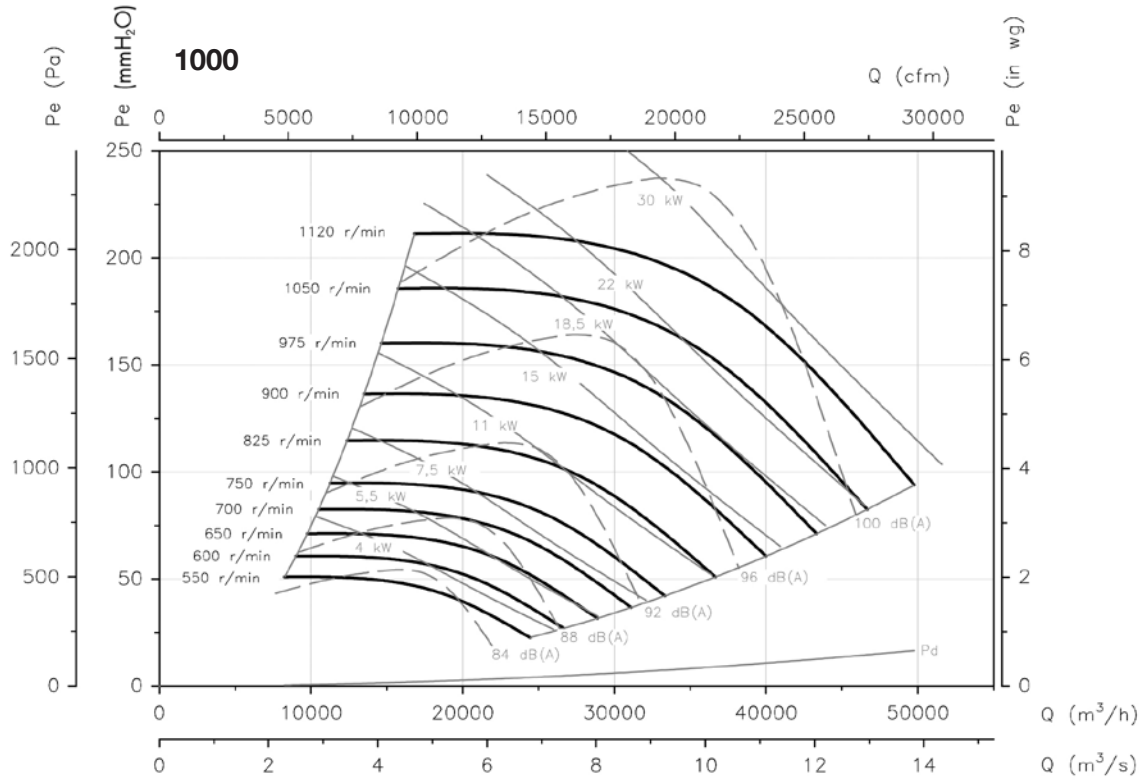

**Accessories**

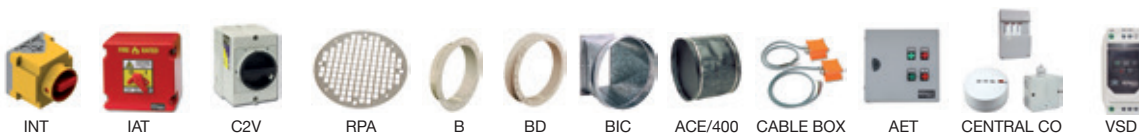

**STAIRCASE OVERPRESSURE KIT**

374

**KIT SOBREPRESIÓN**

Pressurisation system for staircases, escape routes or confinement

381

**KIT BOXPDS**

Pressurisation equipment for staircases, escape routes and fire fighting lobbies

385

**HATCH PDS**

Pressurisation equipment for staircases, escape routes and fire fighting lobbies

387



# PRESSURISATION CONTROL SYSTEMS

SODECA pressurization control systems have been designed in accordance with European standards and with European standard "EN 12101-6 Smoke and heat control systems: Specifications for differential pressure systems

The overpressure smoke control method consists of pressurisation by injecting air into spaces which are used as escape routes by people in the case of fire, such as stairwells, corridors, passageways, lifts, etc. This method is based on smoke control by means of the speed of air and the artificial barrier created by the overpressure.

In accordance with the European standard, there are different classes of differential pressure systems in buildings, depending on their use.

System class	Examples of use
Class A system:	As a means of escape. On-site protection:
Class B system:	As a means of escape and fire fighting
Class C system:	As a means of escape via simultaneous evacuation
Class D system:	As a means of escape. Risk to persons who are sleeping
Class E system:	As a means of escape with evacuation in phases
Class F system:	Fire protection system and means of escape:

In selecting and classifying the system for each specific case, it is necessary to consider the building use, size and evacuation instructions in the event of fire, as this choice will determine the necessary flow rate delivered by the pressurisation equipment. It is very important to pay special attention to the choice of the system as, depending on its class, different flow rates will be required.

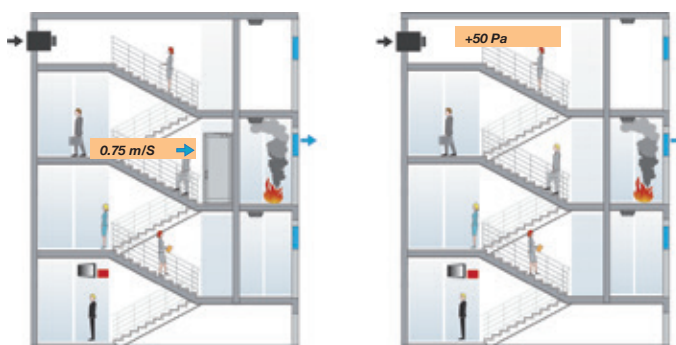

# SYSTEM CLASSES

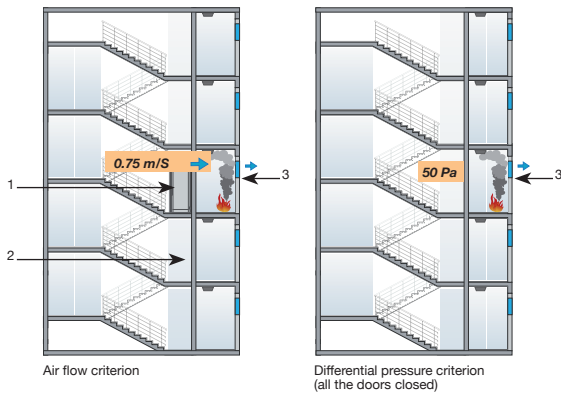

## CLASS A SYSTEM

The project conditions are based on assuming that the building will not be evacuated unless it is directly threatened by the fire.

The level of compartmentalisation of the fire is normally safe for the occupants who remain inside the building.

Therefore it is not very likely that more than one door will be open at the same time in the protected space (either between the stairs and the lobby / corridor or the final exit door).

1. Door open
2. Door closed
3. Air emission flow
- \*An open door may indicate a free passage of air through one lobby

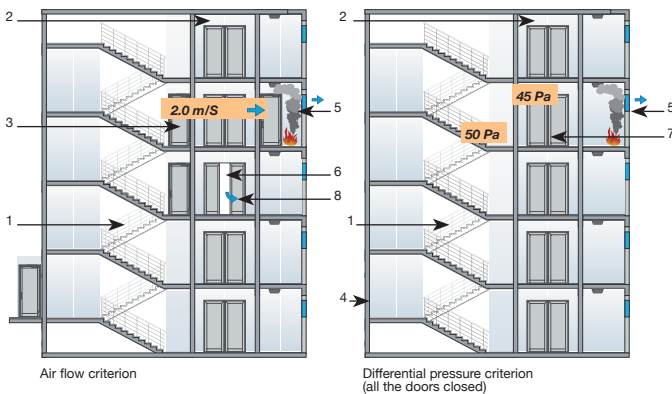

## CLASS B SYSTEM

A class B differential pressure system may be used to minimise the possibility of serious smoke contamination of the fire control stations during the evacuation of persons and while the fire fighters are extinguishing the fire.

During the extinguishing operations, it will be necessary to open the door between the lobby and the living quarters to fight a potentially developed fire.

1. Fire stairs
2. Fire fighting lobbies
3. Door open
4. Door closed
5. Air exhaust openings
6. Door open (fire fighting lobbies)
7. Door closed (fire fighting lobbies)
8. Air flow from fire fighter lift shaft

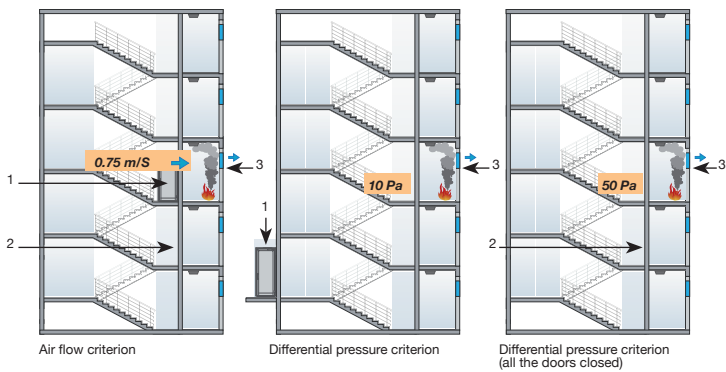

## CLASS C SYSTEM

Class C systems are designed for all the occupants of the building to be evacuated at once when the fire alarm is activated.

In the case of a simultaneous evacuation, it is assumed that the staircase will be occupied for the normal evacuation period and then be free of people. Thus, the evacuation will take place during the first stages of the fire development, and during this period, it is accepted that a certain volume of smoke may reach the staircase.

The air flow contributed by the pressurization system can eliminate that smoke from the staircase.

It is assumed that during the evacuation, the occupants will remain alert and ready, and be familiar with the area in which they are moving, with the ensuing reduction of the time they remain inside the building.

1. Door open
2. Door closed
3. Air exhaust openings
- \*The figure may include lobbies



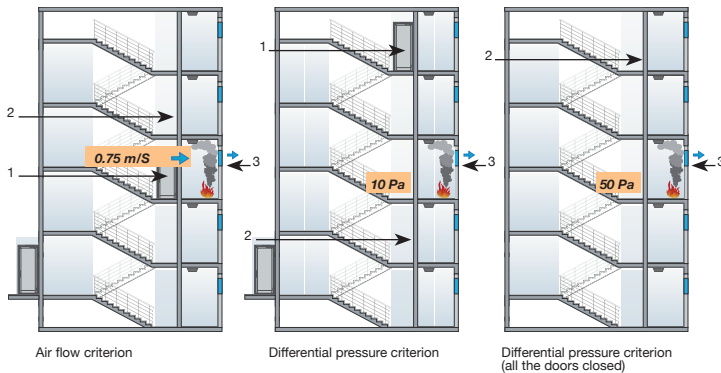

## CLASS D SYSTEM:

Class D systems are designed for buildings where the occupants may be sleeping, for example, hotels, shelters and boarding establishments. The time necessary for the occupants to move in a protected space before reaching the final exit may be longer than that expected in the case of persons who are awake and in good physical condition, and the occupants may not be familiar with the building or need help to reach the final exit / protected space.

- 1. Door open
- 2. Door closed
- 3. Air exhaust openings
- \*The figure may include lobbies

- 1. Door open
- 2. Door closed
- 3. Air exhaust openings
- \*The figure may include lobbies

## CLASS E SYSTEM

They are used in buildings where fire evacuation is done by phases or as staggered evacuations.

In "evacuation by phases" it is considered that the building would still be occupied for a considerable time while the fire is developing, and so higher fire loads must be considered and hence, a larger volume of smoke and hot gases. (These factors may vary considerably, depending on the type of material in combustion, the fire load generated by them and the load geometry).

In such a situation, the protected staircases must be kept free of smoke to allow the safe evacuation of the people occupying the floors where there is no fire.

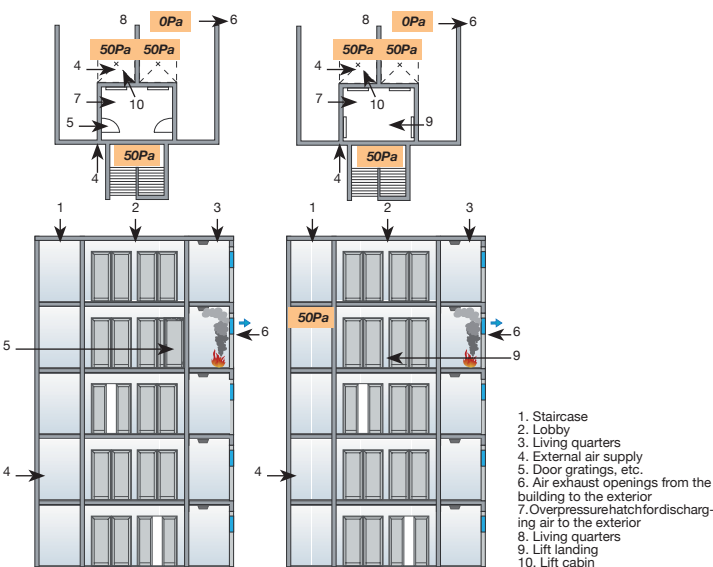
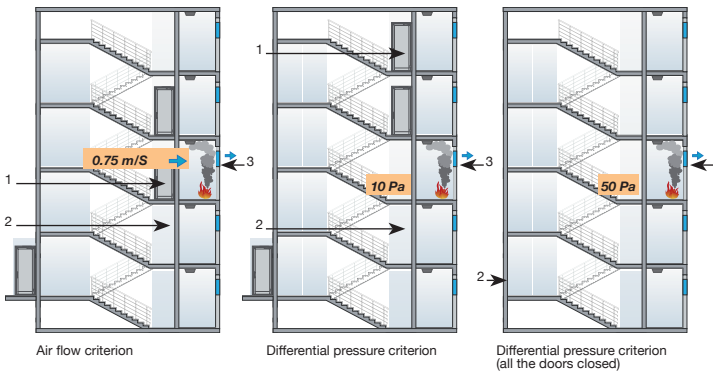

## CLASS F SYSTEM

Class F differential pressure systems are used to minimise the possibility of serious smoke contamination of the staircases that are used by fire fighters while the building is being evacuated and while the fire fighters are extinguishing the fire.

During the extinguishing operations, it will be necessary to open the door between the lobby and the living quarters to fight a potentially developed fire.

This system must be designed so that the stairwell and lift shaft (if any) remain free of smoke. If the smoke enters the lobby, the staircase pressure must not lead the smoke to the shaft, and vice versa.



### Differential pressure criterion

SYSTEM CLASS	A	B	C	D	E	F
Differential pressure between staircase and living quarters (all the doors closed)	50 Pa	50 Pa	50 Pa	50 Pa	50 Pa	50 Pa
Differential pressure on both sides of the living quarters door (final exit door open)	-	-	10 Pa	10 Pa	10 Pa	-
Doors open (differential pressure criterion) Final exit to exterior	NO	NO	YES	YES	YES	NO
Doors open (differential pressure criterion) Fire floor	NO	NO	NO	NO	NO	NO
Doors open (differential pressure criterion) No. of floors other than fire floor	0	0	0	1	2	0
Differential pressure (between lobby and living quarters)	45 Pa*	45 Pa	45 Pa*	45 Pa*	45 Pa*	45 Pa
Differential pressure (between life shaft and living quarters)	-	50 Pa	-	-	-	50 Pa

### Air flow criterion

SYSTEM CLASS	A	B	C	D	E	F	
						Situation 1	Situation 2
Air speed at fire floor door (doors open)	-	2 m/S	0.75 m/S	0.75 m/S	0.75 m/S	-	1 m/S
Air speed at fire floor staircase (doors open)	0.75 m/S	-	-	-	-	2 m/S	-
Doors open Final exit to exterior	NO	YES	NO	YES	YES	YES	YES
Doors open Lift	NO	YES	NO	NO	NO	YES	NO
Doors open Staircase – fire floor lobby	YES	YES	YES	YES	YES	YES	NO
Doors open Staircase – lobby on floor other than fire floor	NO	YES	NO	NO	NO	YES	NO
Doors open Fire floor	YES	YES	YES	YES	YES	YES	YES
Doors open No. of floors other than fire floor	0	0	0	0	1	0	0

\*It is not mandatory to pressurise the lobby if it only has doors connecting it with the staircase and floors.



## Response time

All the systems must be designed so that the force to be applied to the door handle to open it does not exceed 100N.

The SODECA equipment has next-generation, built-in controls that meet the most stringent requirements and are extremely reliable in the face of changes in situation that may occur during a fire, and in "chaotic" evacuation situations in which doors between fire zones and in pressurised smoke-free areas are opened and closed at random. Our systems react quickly and precisely to such changes, always ensuring an Overpressure of 50Pa for closed doors and maintaining the required air speed in each open door situation. This response capacity guarantees that the force used to open a door does not exceed 100N, as set out in European standards.

- t1: Opening of door (1 second)
- t2: Door open. The system delivers 100% of the necessary flow rate in less than 6 seconds
- t3: Closing of door (3 seconds)

The SODECA equipment fully complies with the following reaction times:

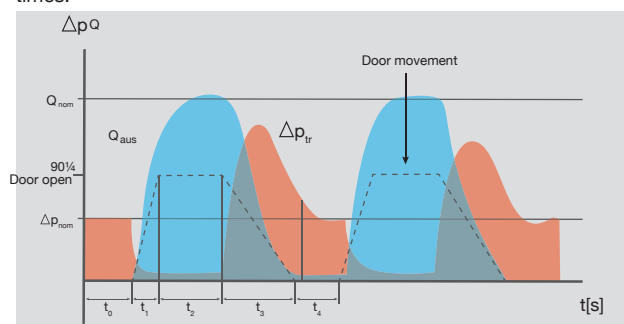

t4: Door closed. The system acquires the nominal pressure in less than 6 seconds, thus preventing prolonged excess pressure and ensuring that the force used on the door handle is no greater than 100N.

Q= Flow rate  
P= Pressure

## Examples of application

The SODECA systems offer different types of equipment to satisfy all installation needs, depending on the building in which the pressurisation control system is used.

When selecting the equipment, it is important to consider where it will be installed and determine the intake of external air and its impulsion to the pressurised zone, based on the following recommendations:

### Intake of external air

The external air inlet must be far from areas where there is a risk of fire, to ensure the entry of clean air through the pressurization system. In the event of an indoor installation, two air intakes will be needed, at a considerable distance from each other, and fitted with smoke detection systems so that if smoke enters through one of the nozzles, it can be closed automatically by a motorised damper (KIT DAMPER) or another equivalent system.

### Impulsion of air to the interior

A single air impulsion point to the pressurised zone is accepted for buildings less than 11 metres in height. For taller buildings, an air entry point must be provided for every three floors, using for example diffusers and an air conduit throughout the entire staircase.

### In technical room

**KIT BOXPDS / KIT SOBREPRESIÓN**



### On the roof

**KIT BOXPDS / HATCH PDS / KIT SOBREPRESIÓN**

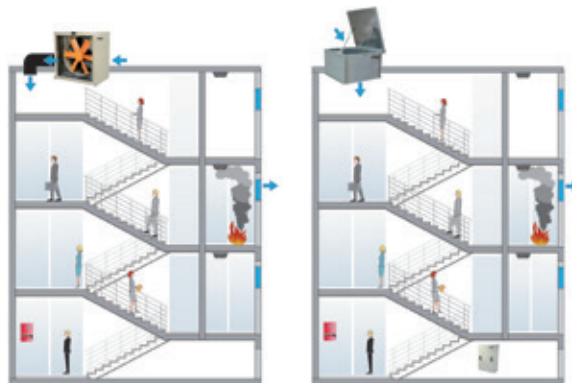

### In separate lobby

**PRESSKIT / KIT SOBREPRESIÓN**





## REAL-LIFE SIMULATION TESTS

All the equipment manufactured by SODECA is subject to stringent tests in real-life simulations using our installations and our test camera with fire doors, motorised dampers for leakage simulation and fire rated door opening/closing operations, in accordance with standard EN-12101-6 Smoke and heat control systems: Specifications for differential pressure systems

Equipment certified by independent laboratories



Certified: NR331151



EN-12101-6  
Smoke and heat control  
systems: Specifications  
for differential pressure systems

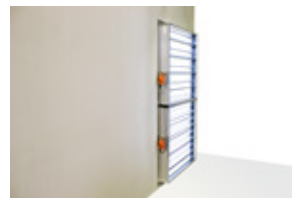

## REMOTE CONNECT START CONTROL

SODECA goes one step further, adapting to new market needs and offering a response to new technological demands. Our systems include advanced options and connectivity to facilitate the supervision and maintenance of the equipment, once installed in any building.

Any BMS (Building Management System) system can be connected to our equipment via the Modbus protocol, allowing end users or maintenance services to supervise the status and correct operation of the systems at all times.

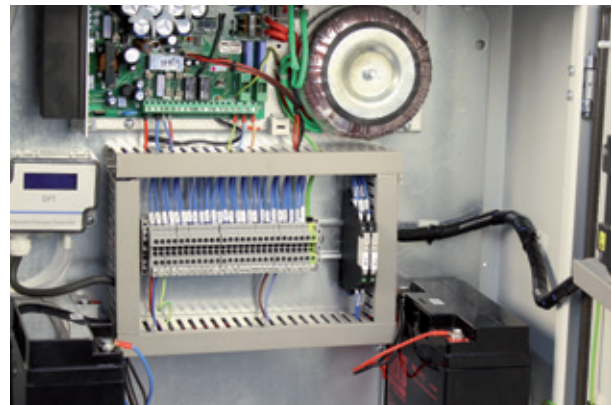

# KIT SOBREPRESIÓN

The staircase, escape routes or confinement pressurization system enables automatic control of the flow rate and the maintenance of a differential pressure of 50 Pa in a single phase, based on standard UNE EN 12101-6-2006

STAIRCASE OVERPRESSURE KIT  
For three-phase equipment



## STAIRCASE OVERPRESSURE KIT

- Staircase overpressure kit comprised of a control panel (BOXPRES KIT) and impulsion units (CJHCH or CJBD), for pressurising staircases and escape routes. Also available for NEOLINEO AND CJBC single-phase equipment.

## OVERPRESSURE KIT WITH RESERVE FAN

- Overpressure kit with reserve fan comprised of a control panel (BOXPRES KIT II) with a built-in automatic switching system that maintains the overpressure in the event of a failure in the main fan and air impulsion units with a TWIN or CJHCH/DUPLEX series reserve fan.

STAIRCASE OVERPRESSURE KIT  
For single-phase equipment



## BOXPRES



- Easy to install
- A compact, autonomous solution
- Preventive maintenance
- Easy start-up
- Safe, functional installation



- The correct operation of the pressurization systems depends not only on their sound design, but also on the correct regulation performed by the system. For this reason, it is extremely important to have calibrated, high precision regulation elements that will permit both situations present in the event of a fire to be maintained simultaneously, quickly and stably.
- The BOXPRES control panel not only complies with the strictest requirements, it simplifies the work for the installer.

It includes:

- A frequency changer programmed at 50 Pa.
- A differential pressure probe.
- A magnetothermal switch.
- A line and failure led lamp.
- A check push button.

All the BOXPRES equipment interconnections have been made and tested.

- Ready to operate and execute its function of controlling the installation pressure.
- Option of checking the installation to prevent failures.
- Only the power supply line, impulsion fan and fire signal need to be connected.

The single-phase panels include:

- A voltage adjuster programmed at 50 Pa.
- A differential pressure probe outside the equipment.

OVERPRESSURE KIT WITH RESERVE FAN



## Order code

**KIT SOBREPRESIÓN — 7.100 — 60Hz**

Kit sobrepresión: Staircase overpressure unit  
Kit sobrepresión II: Overpressure unit with reserve fan

Maximum flow rate

## Technical characteristics

Model	Power supply	Output	Impulsion unit	Flow rate (m <sup>3</sup> /h)	Irradiated sound level * dB(A)
KIT SOBREPRESION-1060-LED	230 Vac II	230 Vac II	NEOLINEO-200	1060	38
KIT SOBREPRESION-2300-LED	230 Vac II	230 Vac II	NEOLINEO-315	2300	47
KIT SOBREPRESION-2880-LED	230 Vac II	230 Vac II	CJBC-2828-6M 1/3	2880	61
KIT SOBREPRESION-7100-LED	230 Vac II	230 Vac III	CJHCH-45-4T-0.5	7100	55
KIT SOBREPRESION-7800-LED	230 Vac II	230 Vac III	CJBD-3333-6T-1.5	7800	55
KIT SOBREPRESION-12900-LED	230 Vac II	230 Vac III	CJHCH-56-4T-1	12900	60
KIT SOBREPRESION-17000-LED	230 Vac II	230 Vac III	CJHCH-63-4T-1.5	17000	61
KIT SOBREPRESION-7100-BOX	400 Vac III	400 Vac III	CJHCH-45-4T-0.5	7100	55
KIT SOBREPRESION-7800-BOX	400 Vac III	400 Vac III	CJBD-3333-6T-1.5	7800	55
KIT SOBREPRESION-12900-BOX	400 Vac III	400 Vac III	CJHCH-56-4T-1	12900	60
KIT SOBREPRESION-17000-BOX	400 Vac III	400 Vac III	CJHCH-63-4T-1.5	17000	61
KIT SOBREPRESION II-6240-BOX	400 Vac III	400 Vac III	TWIN-12/12-6T-1.5	6240	55
KIT SOBREPRESION II-9520-BOX	400 Vac III	400 Vac III	TWIN-15/15-6T-3	9520	54
KIT SOBREPRESION II-12900-BOX	400 Vac III	400 Vac III	CJHCH/DUPLEX-56-4T-1-H	12900	60
KIT SOBREPRESION II-17000-BOX	400 Vac III	400 Vac III	CJHCH/DUPLEX-63-4T-1.5-H	17000	61
SI-PRESIÓN TPDA					
SI-PRESIÓN TPDA w/DISPLAY					
BOXPRES KIT-3A 230Vac	230 Vac II	230 Vac II			
BOXPRES KIT-10A 230Vac	230 Vac II	230 Vac II			
BOXPRES KIT-0.75KW 230Vac	230 Vac II	230 Vac III			
BOXPRES KIT-1.5KW 230Vac	230 Vac II	230 Vac III			
BOXPRES KIT-0.75KW 400Vac	400 Vac III	400 Vac III			
BOXPRES KIT-1.5KW 400Vac	400 Vac III	400 Vac III			
BOXPRES KIT-2.2KW 400Vac	400 Vac III	400 Vac III			
BOXPRES KIT II-1.5KW 400Vac	400 Vac III	400 Vac III			
BOXPRES KIT II-2.2KW 400Vac	400 Vac III	400 Vac III			

## Dimensions mm

## CJHCH



Model	∅A	C	∅D1
CJHCH-40/45/50	700	550	565
CJHCH-56/63	825	550	690

## CJBD

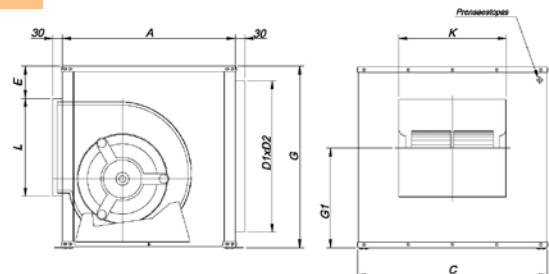

Model	Equiv. inches	A	B	C	E	D1xD2	G1	L	K
CJBD-3333	12/12	650	650	700	92	556X606	379	358	400

## Dimensions mm

### TWIN

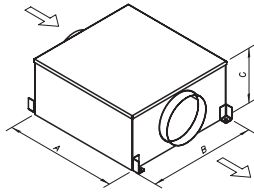

Model	A	B	C
TWIN-12/12	1103	1139	610
TWIN 15/15	1279	1639	698

### CJHCH/DUPLEX

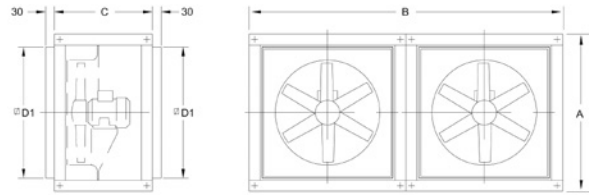

Model	ØA	B	C	ØD1
CJHCH/DUPLEX-56/63	825	1650	550	690

### NEOLINEO

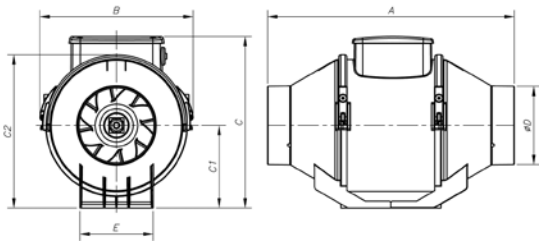

Model	A	B	C	C1	C2	øD	E
NEOLINEO-200	300	234,5	260,5	125,5	235	196	140
NEOLINEO-315	448	361,5	392,5	188,5	359	312	220,5

### CJBC

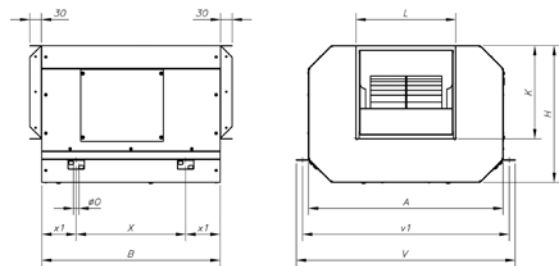

Model	A	B	H	K	L	øO	V	v1	X	x1
CJBC-2828-6M-1/3	696	645	460	290	320	157	725	445	100	

## BOXPRESS KIT SOBREPRESIÓN

### Technical characteristics and dimensions

Model	Power kW	Power supply (V/Hz)	Output (V/Hz)	Outlet current (A)	Size	Measurements (length x width x depth)
BOXPRES KIT-3A 230Vac	-	380 Vac II	380 Vac II	3	-	255 x 170 x 140 mm
BOXPRES KIT-10A 230Vac	-	380 Vac II	380 Vac II	10	-	255 x 170 x 140 mm
BOXPRES KIT-0.75kW 230Vac	0.75	220 V II / 60Hz	220 V II / 60Hz	4.3	1	270x270x170mm
BOXPRES KIT-1.5kW 230Vac	1.5	220 V II / 60Hz	220 V II / 60Hz	7	1	270x270x170mm
BOXPRES KIT-0.75KW 400Vac	0.75	380 V III / 60Hz	380 V III / 60Hz	2,2	1	270x270x170mm
BOXPRES KIT-1.5KW 400Vac	1.5	380 V III / 60Hz	380 V III / 60Hz	4.1	1	270x270x170mm
BOXPRES KIT-2.2KW 400Vac	2.2	380 V III / 60Hz	380 V III / 60Hz	5,8	2	360x360x205mm

### Cable gland for equipment cable entry

#### BOXPRES KIT-3A / KIT-10A

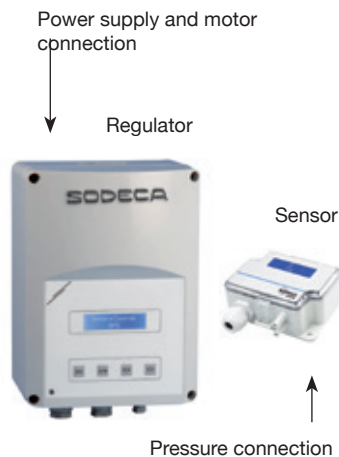

#### BOXPRES KIT size 1 and 2

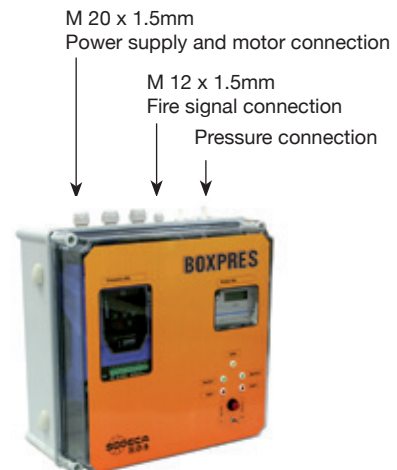

**BOXPRESS KIT SOBREPRESIÓN II**

For equipment with a reserve fan

**Technical characteristics and dimensions**

Model	Power kW	Power supply (V/Hz)	Output (V/Hz)	Outlet current (A)	Size	Measurements (length x width x depth)
BOXPRES KIT II - 1.5KW 400Vac	1.5	380 V III / 60Hz	380 V III / 60Hz	4.1	1	270 x 270 x 170 mm
BOXPRES KIT II - 2.2KW 400Vac	2.2	380 V III / 60Hz	380 V III / 60Hz	5.4	2	360 x 360 x 205 mm

\* Both motors will never operate simultaneously

**Cable gland for equipment cable entry****BOXPRES KIT size 1 and 2**

M 20 x 1.5mm  
Power supply and motor connection

M 12 x 1.5mm  
Fire signal connection

Pressure connection

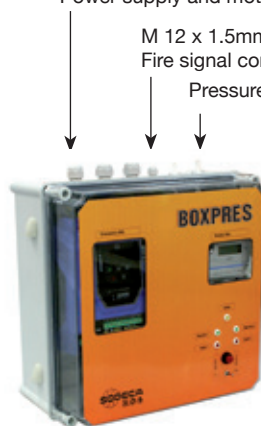
**Example of application**

The overpressure smoke control method consists of pressurisation by injecting air into spaces which are used as escape routes by people in the case of fire, such as stairwells, corridors, passageways, lifts, etc., especially in tall buildings with large occupancy. The method is based on smoke control by the air speed and the artificial barrier created by air overpressure on the smoke, preventing it from entering the escape routes.





# KIT BOXPDS

**Pressurisation equipment for staircases, escape routes and fire fighting lobbies, pursuant to European standard EN 12101-6**

Pressurisation equipment for escape routes in the event of a fire, pursuant to the requirements of European standard EN 12101-6. The KIT BOXPDS automatically regulates the air flow and is able to maintain the 50 Pa overpressure, even in the presence of leakages in the installation. The system can maintain the overpressure (pressure criteria) and a speed of 0.75 m/s in an open door situation (airflow criteria) almost immediately.

## KIT BOXPDS

- It is comprised of the BOXPDS control panel, a CJHCH ventilation unit and a Kit Damper with a built-in optical smoke sensor.

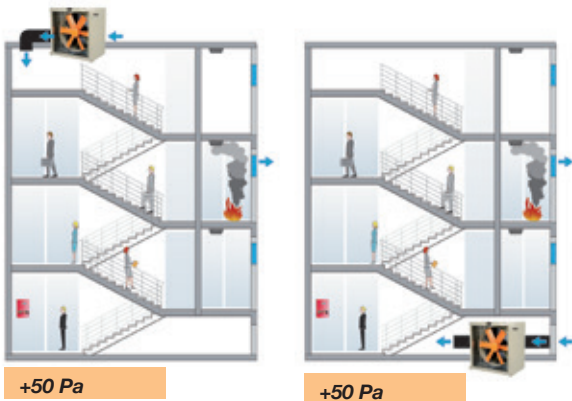

- Easy to install
- A compact, autonomous solution
- Preventive maintenance
- Easy start-up
- Safe, functional installation



BOXPDS

## BOXPDS

- Variable Frequency Drive.
- High precision differential pressure probe.
- Electrical panel with magneto thermal protections and general power supply failure indication.
- Electronic control for the management of alarms, maintenance, ModBUS RTU port for BMS (Building management systems) connection and DAMPER control.
- Certified power supply with batteries to ensure power supply to control equipment in the event of a power failure.



## Control panel:

- External control panel for real-time viewing of pressure, alarm pilot lamps and manual system activation



## Order code

**KIT BOXPDS — 800 — 5.5 — 60Hz**

Pressurisation equipment for staircases, escape routes and fire fighting lobbies

Fan diameter

Power (hp)

**60Hz**

## Technical characteristics

Model	Speed (r/min)	Max. admissible current 400V (A)	Installed power (kW)	Maximum flow rate (m³/h)	Irradiated SPL dB(A)	Approx. weight (kg)
BOXPDS-710-1.5	1680	2.32	1.1	19750	78.75	188
BOXPDS-710-2	1716	3.44	1.5	21100	78.75	190.5
BOXPDS-710-3	1734	4.83	2.2	23950	81.9	200
BOXPDS-800-3	1734	4.83	2.2	28000	82.95	208
BOXPDS-800-4	1734	6.33	3	32700	84	210
BOXPDS-800-5.5	1728	8.12	4	37200	85.05	215

Dimensions mm

KIT BOXPDS

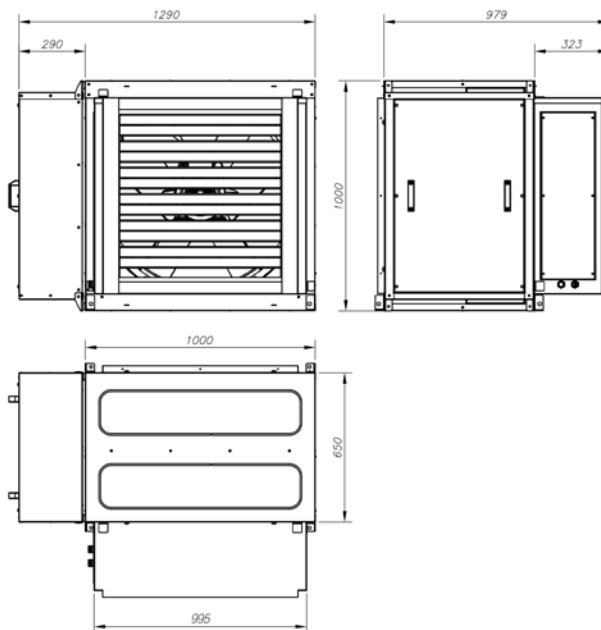
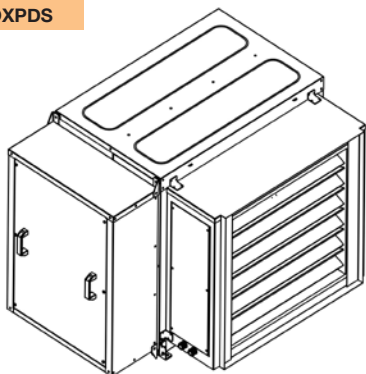

BOXPDS

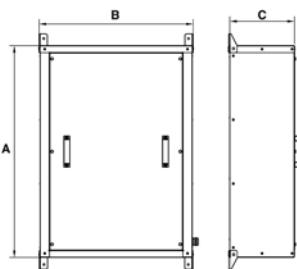

Model	A	B	C
BOXPDS	900	650	280

DAMPER

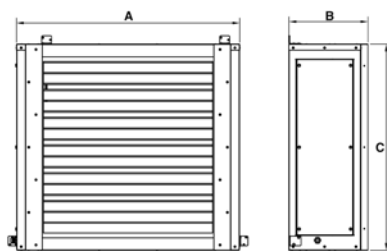

Model	A	B	C
DAMPER	995	326,5	855

CJHCH

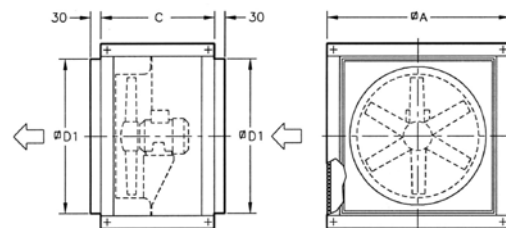

Model	ØA	C	ØD1
CJHCH-71/80	1000	650	850

Examples of application

BOXPDS

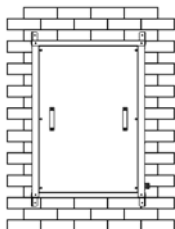

In technical room

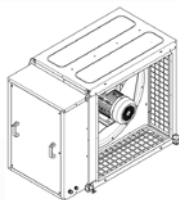

Next to ventilation unit

DAMPER

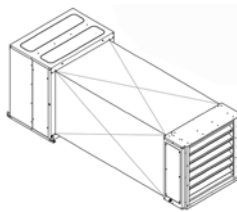

In intake conduit

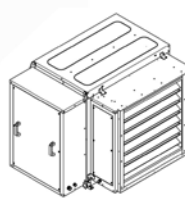

Next to ventilation unit

Two dampers can be used by installing two intake points at a considerable distance from the fan, so that one of the points is always in the open position and the other closed. In the event of smoke being detected in the intake nozzle with an open damper, the damper closes and the second damper opens to ensure the entry of clean air into the space to be protected (smoke-free escape route).

# HATCH PDS

## ***Pressurisation equipment for staircases, escape routes and fire fighting lobbies, pursuant to European standard EN 12101-6***

Pressurisation equipment for escape routes in the event of a fire, pursuant to the requirements of European standard EN 12101-6. The HATCH PDS automatically regulates the air flow and is able to maintain the 50 Pa overpressure, even in the presence of leakages in the installation. The system can maintain the overpressure (pressure criteria) and a speed of 0.75 m/s in an open door situation (airflow criteria) almost immediately.

### **HATCH PDS**

It is formed by a HATCH-S ventilation unit with a motorized hatch opening function and a BOXPDS control panel.

- An extremely robust structure that is able to withstand severe weather changes.
- Equipment structure made of corrosive-proof galvanised sheet steel.
- Water-tight design to prevent the entry of water.
- Heat insulation to prevent hot air loss in the winter.
- Adaptable skirting for correct, easy installation on the roof.

#### Opening system:

- Motorised opening arms, with encapsulated IP-65 mechanism.
- Supply voltage 230 V AC 60Hz or 24V DC.
- Reinforced, guaranteed system with more than 10,000 operations at maximum load.
- Maximum load 1000 Nw.
- Automatic opening via external control system signal (fire station, smoke detector, manual switch...).
- Control systems not included in the supply.
- Manual opening for environmental ventilation via switch.
- Limit switch to signal the hatch position.

#### Fan:

- HCT series extractor fans.
- Tubular casing made of sheet steel with polyester resin anti-corrosive treatment.
- Cast aluminium rotors.

#### Motor:

- IE3 efficiency motors for powers equal to or greater than 0.75kW except single-phase, 2-speed and 8-pole.
- Class F motors with ball bearings and IP55 protection.
- Multi voltage motor, special design valid for 220/380V 60Hz, 254/440V 60Hz, 265/460V 60Hz, 277/480V 60Hz.
- Operating temperature: -25°C +50 °C.

#### Finish:

- Anti-corrosive finished galvanised sheet steel.

#### On request:

- Fitted with F-300 and F-400 rated fans.
- Reversible pressurisation equipment for smoke evacuation in case of need.
- Polyester resin anti-corrosive paint finish.

### **BOXPDS**

- Variable Frequency Drive.
- High precision differential pressure sensor.
- Electrical panel with magneto thermal protections and general power supply failure indication.
- Electronic control for the management of alarms, maintenance, ModBUS RTU port for BMS (Building management systems) connection and DAMPER control.
- Certified power supply with batteries to ensure power supply to control equipment in the event of a power failure.

#### Control panel:

- External control panel for real-time viewing of pressure, alarm pilot lamps and manual system activation.



+50 Pa

## Order code

<b>HATCH PDS</b>	<b>— 80</b>	<b>— 4T</b>	<b>—</b>	<b>5.5</b>	<b>— N</b>	<b>—</b>	<b>1</b>	<b>—</b>	<b>G</b>	<b>— 60Hz</b>
Model	Size	Number of motor poles 2=3500 r/min. 60 Hz 4=1680 r/min. 60 Hz 6=1080 r/min. 60 Hz	T= Three-phase	Motor power (hp)	Electric accessories N= no accessories Y= Limit switch		Opening system supply voltage 1=230 V.AC 2=24 V.DC		Finish G=galvanised P=painted in special colour	

60Hz

## Technical characteristics

Model	Speed (r/min)	Maximum admissible current (A)		Installed power (kW)	Maximum flow rate (m <sup>3</sup> /h)	Sound pressure level dB(A)	Approx. weight (kg)
		220-277V	380-480V				
HATCH PDS-40-2T-1	3420	3.15	1.80	0.75	6115	76.60	184
HATCH PDS-40-2T-1.5	3456	4.70	2.70	1.10	7050	76.65	188
HATCH PDS-45-2T-2	3456	5.90	3.40	1.50	9405	78.75	193
HATCH PDS-45-2T-3	3408	8.70	5.00	2.20	11325	80.85	194
HATCH PDS-50-2T-2	3456	5.90	3.40	1.50	10100	80.85	197
HATCH PDS-50-2T-3	3408	8.70	5.00	2.20	11925	81.90	199
HATCH PDS-50-2T-4	3456	11.20	6.50	3.00	13860	82.95	206
HATCH PDS-50-2T-5.5	3444		9.30	4.00	15900	84.00	222
HATCH PDS-56-2T-5.5	3444		9.50	4.00	18840	89.25	226
HATCH PDS-56-2T-7.5	3492		10.60	5.50	22510	90.30	237
HATCH PDS-56-4T-2	1728	6.20	3.60	1.50	15020	75.60	205
HATCH PDS-63-4T-3	1710	9.00	5.20	2.20	22460	76.65	262
HATCH PDS-63-4T-4	1716	11.40	6.60	3.00	24460	77.70	271
HATCH PDS-63-6T-1	1128	4.70	2.70	0.75	16025	66.15	252
HATCH PDS-80-4T-3	1710	9.00	5.20	2.20	25545	82.95	280
HATCH PDS-80-4T-4	1716	11.40	6.60	3.00	30410	84.00	289
HATCH PDS-80-4T-5.5	1728		8.40	4.00	32940	85.05	295
HATCH PDS-80-4T-7.5	1752		12.60	5.50	39820	86.10	311
HATCH PDS-80-6T-1.5	1134	5.50	3.20	1.10	21580	72.45	279
HATCH PDS-80-6T-2	1134	7.40	4.30	1.50	26090	73.50	288
HATCH PDS-90-4T-7.5	1752		12.60	5.50	46325	92.40	392
HATCH PDS-90-4T-10	1752		17.70	7.50	50315	93.45	403
HATCH PDS-90-4T-15	1752		22.00	11.00	59610	94.50	456
HATCH PDS-90-6T-3	1140	9.50	5.50	2.20	34055	78.75	365
HATCH PDS-90-6T-4	1164	13.50	7.80	3.00	39055	79.80	391
HATCH PDS-100-4T-10	1752		17.70	7.50	57650	94.50	413
HATCH PDS-100-4T-15	1752		22.00	11.00	66505	95.55	466
HATCH PDS-100-6T-5.5	1164		11.00	4.00	47955	85.05	413
HATCH PDS-100-6T-7.5	1164		12.40	5.50	53545	86.10	420

**Technical characteristics of the dynamic discharge system based on standard EN 12101-3:2002/AC:2006**

Model	Approval °C	Motor insulation class	Durability	Minimum room temperature	Wind load (Pa)	Snow load (Pa)
HATCH PDS	-	Class F	RE 10000	T(-15)	WL 1500	SL 500

## Acoustic characteristics

The values given are determined by measuring the noise power in dB(A) obtained in a free field at a distance equivalent to twice the size of the fan plus the rotor diameter, with a minimum of 1.5 m.

Sound power spectrum Lw(A) in dB(A) per Hz frequency band

Model	63	125	250	500	1000	2000	4000	8000	Model	63	125	250	500	1000	2000	4000	8000
40-2-1	44	65	72	77	80	76	69	58	80-4-4	54	74	82	87	89	86	79	71
40-2-1.5	45	66	73	78	81	77	70	59	80-4-5.5	54	74	82	87	89	86	79	72
45-2-2	47	68	75	80	83	79	72	61	80-4-7.5	55	75	83	88	90	87	80	73
45-2-3	49	70	77	82	85	81	74	63	80-6-1.5	47	64	72	77	79	76	69	58
50-2-2	52	72	80	85	87	84	77	66	80-6-2	48	65	73	78	80	77	70	59
50-2-3	53	73	81	86	88	85	78	67	90-4-7.5	57	78	85	90	93	89	82	71
50-2-4	54	74	82	87	89	86	79	68	90-4-10	56	77	84	89	92	88	81	70
50-2-5.5	55	75	83	88	90	87	80	69	90-4-15	58	79	86	91	94	90	83	72
56-2-5.5	60	80	88	93	95	92	85	74	90-6-3	54	68	75	80	83	79	72	61
56-2-7.5	61	81	89	94	96	93	86	75	90-6-4	55	70	77	82	85	81	74	63
56-4-2	47	67	75	80	82	79	72	61	100-4-10	60	80	88	93	95	92	85	74
63-4-3	50	68	76	81	83	80	75	64	100-4-15	59	79	87	92	94	91	84	73
63-4-4	51	69	77	82	84	81	76	65	100-4-20	61	81	89	94	96	93	86	75
63-6-1	41	60	68	73	75	72	65	55	100-6-5.5	62	71	79	84	86	83	76	65
80-4-3	56	75	83	89	90	87	81	70	100-6-7.5	63	72	80	85	87	84	77	66

## Dimensions mm

### HATCH PDS

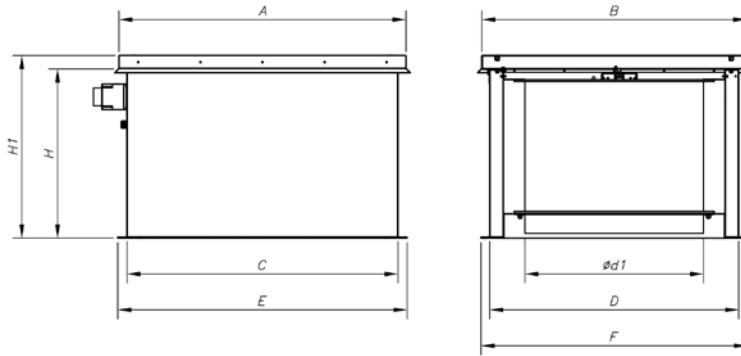

Model	A	B	C	D	ød1	E	F	H	H1	Model	A	B	C	D	ød1	E	F	H	H1
HATCH PDS-40-2T-1	1100	990	1022	920	400	1100	1000	760	820	HATCH PDS-80-4T-4	1295	1195	1222	1122	800	1300	1200	760	820
HATCH PDS-40-2T-1.5	1100	990	1022	920	400	1100	1000	760	820	HATCH PDS-80-4T-5.5	1295	1195	1222	1122	800	1300	1200	760	820
HATCH PDS-45-2T-2	1100	990	1022	920	450	1100	1000	760	820	HATCH PDS-80-4T-7.5	1295	1195	1222	1122	800	1300	1200	760	820
HATCH PDS-45-2T-3	1100	990	1022	920	450	1100	1000	760	820	HATCH PDS-80-6T-1.5	1295	1195	1222	1122	800	1300	1200	760	820
HATCH PDS-50-2T-2	1100	990	1022	920	500	1100	1000	760	820	HATCH PDS-80-6T-2	1295	1195	1222	1122	800	1300	1200	760	820
HATCH PDS-50-2T-3	1100	990	1022	920	500	1100	1000	760	820	HATCH PDS-90-4T-7.5	1492	1392	1420	1320	900	1500	1400	860	920
HATCH PDS-50-2T-4	1100	990	1022	920	500	1100	1000	760	820	HATCH PDS-90-4T-10	1492	1392	1420	1320	900	1500	1400	860	920
HATCH PDS-50-2T-5.5	1100	990	1022	920	500	1100	1000	760	820	HATCH PDS-90-4T-15	1492	1392	1420	1320	900	1500	1400	860	920
HATCH PDS-56-2T-5.5	1100	990	1022	920	560	1100	1000	760	820	HATCH PDS-90-6T-3	1492	1392	1420	1320	900	1500	1400	860	920
HATCH PDS-56-2T-7.5	1100	990	1022	920	560	1100	1000	760	820	HATCH PDS-90-6T-4	1492	1392	1420	1320	900	1500	1400	860	920
HATCH PDS-56-4T-2	1100	990	1022	920	560	1100	1000	760	820	HATCH PDS-100-4T-10	1492	1392	1420	1320	1000	1500	1400	860	920
HATCH PDS-63-4T-3	1295	1195	1222	1122	630	1300	1200	760	820	HATCH PDS-100-4T-15	1492	1392	1420	1320	1000	1500	1400	860	920
HATCH PDS-63-4T-4	1295	1195	1222	1122	630	1300	1200	760	820	HATCH PDS-100-4T-20	1492	1392	1420	1320	1000	1500	1400	860	920
HATCH PDS-63-6T-1	1295	1195	1222	1122	630	1300	1200	760	820	HATCH PDS-100-6T-5.5	1492	1392	1420	1320	1000	1500	1400	860	920
HATCH PDS-80-4T-3	1295	1195	1222	1122	800	1300	1200	760	820	HATCH PDS-100-6T-7.5	1492	1392	1420	1320	1000	1500	1400	860	920

### BOXPDS

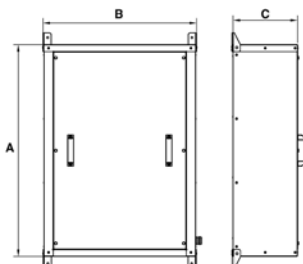

Model	A	B	C
BOXPDS	900	650	280

ATEX CERTIFIED

**ATEX EXTRACTOR FANS FOR EXPLOSIVE ATMOSPHERES**



**EAC**



390

**HCDF**



Axial extractor fans with a square frame and ATEX Ex d certification

397

**HDF**



Axial fans with a circular frame and ATEX Ex d certification

397

**HCH/ATEX**



Extremely robust, wall-mounted axial extractor fans with ATEX certification

400

**HCT/ATEX**



Extremely robust, wall-mounted axial extractor fans with ATEX certification

400

**CMA/ATEX**



Medium pressure, centrifugal fans made of cast aluminium, with ATEX certification

404

**CMP/ATEX**



Wall-mounted medium pressure centrifugal fans fitted with multi-blade impeller and with ATEX certification

406

**CMR/ATEX**



Extremely robust, medium pressure, centrifugal extractor fans fitted with reaction impeller and with ATEX certification

410



# ATEX EXPLOSIVE ATMOSPHERES

All the extractors and fans manufactured by SODECA for explosive atmospheres comply with the requirements of the European ATEX 94/9/EC Directive and have been designed in accordance with standard EN-14986 "Design of fans working in potentially explosive atmospheres". This guarantees product quality and ensures the maximum safety of people and facilities.

## ATEX EXPLOSIVE ATMOSPHERE APPLICATIONS



**EAC**

### Fan design:

In accordance with standard EN-14986 and to prevent ignition in the event of friction or impact between the moving and the static parts, they are made with materials that are compatible with each other to prevent sparks.

#### Centrifugal fans:

##### To prevent sparks generated by the impeller:

- . Copper intake nozzle
- . Protective bushings to protect the screwed/riveted joints
- . Verification of distances between components

#### Axial fans:

##### - To prevent sparks generated by the rotor:

- . Copper or aluminium strip over the inner side of the ring
- . Verification of distances between components

Pursuant to the standard, all the fan parts that are not welded together and secured using mechanical means through other systems or are different parts coated with paint that could insulate conductivity are joined by equipotential bonding to prevent differences in power between these non-welded or painted parts.

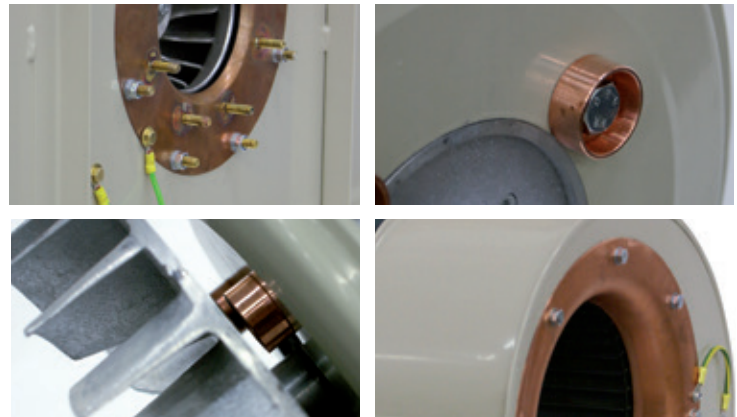

Since it was first established, Sodeca has specialised in the design and manufacture of fans and their accessories for industrial applications.

The combination of its experience gained over decades of working with fans and the technology provided by the engineers employed in its different departments has allowed Sodeca to occupy a leading international position as a fan manufacturer.

Industrial applications require an important capacity to adapt to the specifications of each project and flexibility in production in order to comply with the real needs of each client.

To comply with this objective, Sodeca has a standard products line and a specially-manufactured products line for building fans that meet the demands of our clients.

In the different projects we can use motors that meet the most stringent market standards:

NEMA super premium efficiency

NEMA premium efficiency

NEMA high efficiency

U.L. motors

C.S.A. motors

## COMPLIANCE WITH STANDARDS

**SODECA fans and extractors comply with the following standards:**

<b>QUALITY</b>	
<b>ISO 9001:2015</b>	Sistemas de gestión de la calidad. Requisitos. Quality management systems -- Requirements
<b>TRIALS</b>	
<b>ISO 5801</b>	Ventiladores industriales. Ensayos de comportamiento en circuitos normalizados. Industrial fans -- Performance testing using standardized airways
<b>AMCA 210-07</b>	Ventiladores industriales. Métodos de ensayos de ventiladores y su representación de ensayos. Laboratory Methods of Testing Fans for Aerodynamic Performance Rating
<b>UNE-EN ISO 5801</b>	Ventiladores. Dispositivos e instalaciones para el ensayo de ventiladores.
<b>UNE-EN ISO 13350</b>	Ventiladores industriales. Ensayos de comportamiento de ventiladores de chorro. Industrial fans -- Performance testing of jet fans
<b>ISO 13348</b>	Industrial fans -- Tolerances, methods of conversion and technical data presentation
<b>HIGH TEMPERATURE FANS</b>	
<b>EN 12101-3</b>	Sistemas de control de humos y calor. Parte 3: Especificaciones para aireadores extractores de humos y calor mecánicos. Smoke and heat control systems - Part 3: Specification for powered smoke and heat exhaust ventilators
<b>ACOUSTICS</b>	
<b>ISO 3744</b>	Acústica. Determinación de los niveles de potencia acústica de fuentes de ruido a partir de la presión acústica. Método de ingeniería para condiciones de campo libre sobre un plano reflectante. Acoustics -- Determination of sound power levels of noise sources using sound pressure -- Engineering method in an essentially free field over a reflecting plane
<b>BALANCING AND VIBRATIONS</b>	
<b>ISO 1940-1</b>	Vibraciones mecánicas. Calidad de equilibrio Mechanical vibration -- Balance quality requirements for rotors in a constant (rigid) state -- Part 1: Specification and verification of balance tolerances
<b>ISO 10816-1</b>	Vibraciones mecánicas. Evaluación de las vibraciones de máquinas Mechanical vibration -- Evaluation of machine vibration by measurements on non-rotating parts -- Part 1: General guidelines
<b>ISO 14694</b>	Ventiladores industriales. Especificaciones para equilibrado y niveles de vibración Industrial fans -- Specifications for balance quality and vibration levels
<b>SAFETY (EC Declaration of Conformity)</b>	
<b>EN ISO 12100</b>	Seguridad de las máquinas. Conceptos básicos, principios generales para el diseño. Parte 1: Terminología básica, metodología. Safety of machinery -- Basic concepts, general principles for design -- Part 1: Basic terminology, methodology
<b>EN ISO 12100</b>	Seguridad de las máquinas. Conceptos básicos, principios generales para el diseño. Parte 2: Principios técnicos. Safety of machinery -- Basic concepts, general principles for design -- Part 2: Technical principles
<b>UNE EN 60204-1</b>	Seguridad de las máquinas. Equipo eléctrico de las máquinas. Parte 1: Requisitos generales. Safety of machinery - Electrical equipment of machines - Part 1: General requirements
<b>ISO 13857</b>	Seguridad de máquinas. Distancias de seguridad para impedir que se alcancen zonas peligrosas con los miembros superiores e inferiores. Safety of machinery -- Safety distances to prevent danger zones being reached by upper and lower limbs
<b>UNE-EN ISO 12499</b>	Ventiladores industriales. Seguridad mecánica en los ventiladores Industrial fans -- Mechanical safety of fans -- Guarding
<b>DIRECTIVES AND REGULATIONS</b>	
<b>Directiva 2006/42/CE</b>	Directiva de máquinas Machinery Directive
<b>Directive 2014/35/UE</b>	Directiva de baja tensión Low Voltage Directive
<b>Directive 2014/30/UE</b>	Directiva compatibilidad electromagnética EMC Directive
<b>Regulation 305/2011</b>	Directiva productos de construcción Construction Products Directive (CPR)
<b>Directive 2009/125/CE</b>	Directiva de requisitos de diseño ecológico para productos que utilizan energía. Ecodesign Requirements for Energy-related Products Directive

### AEX EXECUTIONS

<b>ATEX directive 2014/34/UE</b>	Aparatos y sistemas de protección para uso en atmósferas potencialmente explosivas Equipment and protective systems intended for use in potentially explosive atmospheres
<b>EN 14986</b>	Diseño de ventiladores para trabajar en atmósferas potencialmente explosivas. Design of fans working in potentially explosive atmospheres
<b>EN 13463-1</b>	Equipos no eléctricos destinados a atmósferas potencialmente explosivas. Parte 1: Requisitos y metodología básica. Non-electrical equipment for use in potentially explosive atmospheres - Part 1: Basic method and requirements
<b>EN 1127-1</b>	Explosive atmospheres. Prevención y protección contra la explosión. Parte 1: Conceptos básicos y metodología. Explosive atmospheres - Explosion prevention and protection - Part 1: Basic concepts and methodology





## Extractor fans for ATEX EXPLOSIVE ATMOSPHERES

An ATEX zone is an area containing a mixture of air with inflammable **gas**, inflammable liquid **vapour**, combustible liquid **mist** or combustible **dust** and when they ignite, they all do so at once.



### Sensitivity to gas ignition:

<b>LEL</b>	Lower explosive limit » % volume.
<b>UEL</b>	Upper explosive limit » % volume.
<b>MIE</b>	Minimum ignition energy at » 10-6 µ Joules
<b>Flash Point</b>	Minimum temperature of a liquid forming inflammable gases
<b>Ignition Temperature</b>	Temperature at which a gas ignites (T1, T2, T3, T4, T5 y T6)

### Sensitivity to ignition of solids:

<b>LEL or MEC</b>	Minimum explosive concentration » g/m <sup>3</sup>
<b>LOC</b>	Limiting oxygen concentration » % volume
<b>MIE</b>	Minimum ignition energy at » 10-3 µ Joules
<b>MIT</b>	Minimum ignition temperature in °C: <ul style="list-style-type: none"> <li>- In a MIT cloud n (cloud of dust in contact with a hot surface).</li> <li>- In a MIT layer c with ignition of a layer of 5 mm.</li> <li>- (limit of T the lesser of: 2/3 of MIT n or MIT c -75 °C)</li> </ul>

### Summary of zone definitions

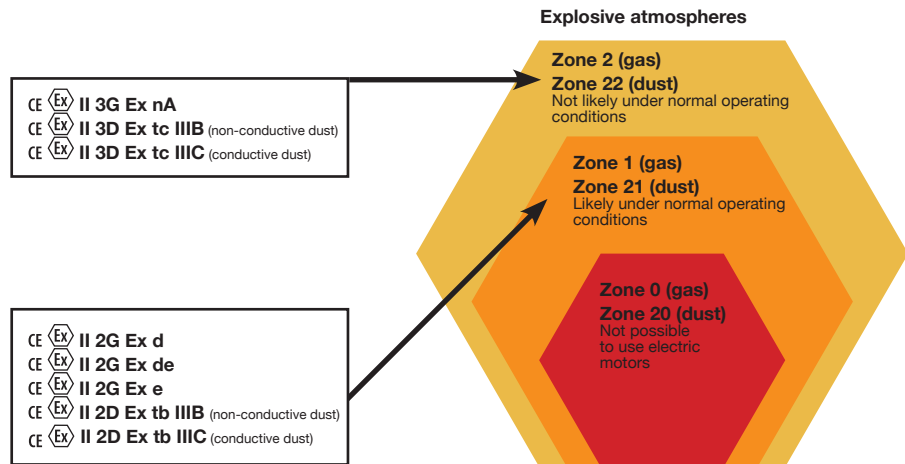

### Definition of zones:

Gases and vapours / Dust:

- **Zone 0 / Zone 20:**  
Constantly present during long periods of time or frequently.  
Not possible to use electric motors
- **Zone 1 / Zone 21:**  
Likely under normal operating conditions.
- **Zone 2 / Zone 22:**  
Not likely that an ATEX zone will be created under normal operating conditions

### Appliance groups and categories:

**GROUP I: equipment for underground and surface mining work with hazards posed by firedamp or explosive dust.**

- Category M1: must remain operative
- Category M2: must be able to shut off the power supply

**GROUP II: Other risk zones**

- Category 1: very high level of protection. Very likely zone.
- Category 2: high level of protection. Likely zone.
- Category 3: normal level of protection. Not a very likely zone.

**Selection of category depending on zone:**

ZONE	CATEGORY
0 or 20	1
1 or 21	1 or 2
2 or 22	1, 2 or 3

**Selection of zone depending on category:**

CATEGORY	ZONE
1	All
2	1, 21, 2 or 22
3	2 or 22

**Explosion group and temperature class**

Explosion group	Temperature class						
	T1	T2	T3	T4	T5	T6	
II A	Acetone Ethane Ethyl acetate Ethyl chloride Ammonia Benzene Acetic acid	Carbon oxide Methane Methanol Methyl chloride Propane Natural gas Toluene	1-amyl acetate Butane n-butyl alcohol Cyclohexane 1,2-dichloroethane Acetic anhydride	Gasoline Otto fuels Aviation fuel Fuel oils Hexane	Acetaldehyde		
II B		Ethyl alcohol Ethylene Ethylene oxide	Hydrogen sulphide	Ethyl ether			
II C	Hydrogen	Acetylene				Carbon sulphide	

**Temperature class and ignition temperature:**

Temperature class	Ignition temperature
T1	>450 °C
T2	>300 °C
T3	>200 °C
T4	>135 °C
T5	>100 °C
T6	>85 °C

**Solid fuel explosive values**

Product	Kmax	Pmax	MIE	LOC	TMIn	TIMc
Corn flour	127	6.7	300	--	530	460
Rice flour	40	6.7	>10	--	370	480
Wheat flour	47	8.2	>300	11%	460	470
Malted flour	100	7.8	>10	11%	310	460
Corn starch	143	10.6	>100	9%	440	400
Rice starch	220	10.0	>10	--	470	390
Potato starch	89	9.4	>3000	--	520	570

**ATEX marked**

Motors marked in accordance with ATEX directive

CE	0081	Ex	II	2	G/D
Marking CE	Name of the certifying body (e.g. LCIE)	Marking CE for Ex products	Grouping of electrical appliances	Equipment category (2 or 3)	Gas or Dust

**EN marked**

Additional standard marking for motors

Ex	d	II	C	T4	Gb
Appliance protected against explosions	Type of protection except mines	Groups (all)	Groups depending on gas (only necessary for explosion-proof equipment)	Temperature class	Level of protection against explosion



### Combustible gas explosive values

	Gas group	%vol LEL	g/mol M		Gas group	%vol LEL	g/mol M
Methane	I	5.0	16.04	Chloroethane	IIA	3.6	64.51
Amyl acetate	IIA	1.1	130.19	Chloroethane	IIIA	5.0	106.97
Butyl acetate	IIA	1.2	116.16	Chloroethylene(vinyl chloride)	IIA	3.8	62.50
Ethyl acetate	IIA	2.1	88.11	Chloromethane	IIA	7.6	50.49
Methyl acetate	IIA	3.1	74.08	Chloropropane	IIA	2.6	78.54
Propyl acetate	IIA	1.7	102.13	Cetyl chloride	IIA	5.0	78.50
Acetone	IIA	2.2	55.06	Allyl chloride	IIA	3.3	76.53
Acetonitrile	IIA	3.0	41.05	Cresium	IIIA	1.0	108.14
Acetic acid	IIA	4.0	60.05	Decahydronaphthalene(decaline)	IIA	0.7	138.25
Acetic aldehyde	IIA	4.0	44.05	Decane	IIA	0.81	42.28
Ammonia	IIA	15.0	17.03	Diacetone alcohol	IIIA	1.8	116.16
Aniline	IIA	1.2	107.13	Dichloroethane	IIA	5.6	98.96
Benzene	IIA	1.2	78.11	Dichloroethylene	IIA	6.5	96.94
Bromobutane	IIA	2.6	137.02	Dichloropropane	IIA	3.4	112.99
Bromoethane	IIA	6.7	108.97	Diethylamine	IIA	1.7	73.14
Butane	IIA	1.5	58.12	Dimethylamine	IIA	2.8	45.08
Butane	IIIA	1.4	74.12	Dimethylamine	IIA	1.2	121.18
Butyl methyl ketone	IIA	1.2	100.16	Dipropyl ether	IIA		102.18
Butylamine	IIA	1.7	73.14	Styrene	IIA	1.1	104.15
Cyclobutane	IIA	1.8	56.11	Ethane	IIA	3.0	30.07
Cyclohexane	IIA	1.2	84.16	Ethane	IIIA	3.3	46.07
Cyclohexane	IIIA	1.2	100.16	Ethyl methyl ketone	IIA	1.8	72.11
Cyclohexanone	IIA	1.3	98.14	Ethylbenzene	IIA	1.0	106.17
Cyclopentane	IIA	1.1	70.13	Ethyl mercaptan	IIA	2.8	62.13
Chlorobenzene	IIA	1.1	112.56	Feno	IIIA	1.3	94.11
Chlorobutane	IIA	1.8	92.57	Ethyl formate	IIA	2.7	74.08



**INDUSTRIAL  
APPLICATIONS**



**ATEX EXPLOSIVE  
ATMOSPHERE  
APPLICATIONS**



**NAVAL  
APPLICATIONS**

### Combustible gas explosive values

	Gas group			%vol	LEL	g/mol	M		Gas group			%vol	LEL	g/mol	M
Methyl formate	IIA	5	60.05					Trimethylamine	IIA	2.0	59.11				
Gasoline				0.7	73.95			Xylene	IIA	1.0	106.17				
Heptane			IIA	1.1	100.20			1,2-epoxypropane (propylene oxide)	IIB	1.9	58.08				
Hexane			IIA	1.2	86.18			1,3,5-trioxane	IIB	3.6	90.08				
Hexane			IIIA	1.2	102.18			1,3-butadiene	IIB	1.4	54.09				
Kerosene			IIA	0.7	87.00			1,4-dioxane	IIB	1.9	88.11				
Methylamine			IIA	4.9	31.06			Cyanhydric acid	IIB	46.5	27.03				
Methylcyclohexane			IIA	1.1	98.19			Ethyl acrylate	IIB	1.7	100.12				
Carbon monoxide			IIA	12.5	28.01			Methyl acrylate	IIB	2.4	86.09				
Naphthalene			IIA	0.9	128.17			Acrylonitrile	IIB	2.8	53.06				
Nitroethane			IIA	4.0	75.07			Tetrahydrofurfuric alcohol	IIB	1.5	102.13				
Nitromethane			IIA	7.1	61.04			Cyclopropane	IIB	2.4	42.08				
Nonane			IIA	0.7	128.26			Dibutyl ether	IIB	0.9	130.23				
Nonane			IIIA	8.0	144.26			Diethyl ether	IIB	1.9	74.12				
Octane			IIA	6.0	114.23			Ethyl methyl ether	IIB	2.0	60.10				
Pentane			IIA	1.4	72.15			Ethylene	IIB	2.7	28.05				
Pentane			IIIA	1.2	88.15			Furan	IIB	2.3	68.08				
Petroleum			IIA	1.0	87.00			Coke oven gas	IIB	5.0					
Pyridine			IIA	1.7	79.10			Methylacetylene (propyne)	IIB	1.7	40.06				
Propane			IIA	2.0	44.10			Isopropyl nitrate	IIB	2.0	105.09				
Propane			IIIA	2.1	60.10			Ethylene oxide (epoxyethane)	IIB	2.6	44.05				
Propene (propylene)			IIA	2.0	42.08			Tetrahydrofuran	IIB	1.5	72.11				
Propylamine			IIA	2.0	59.11			Acetylene	IIC	1.5	26.04				
Toluene			IIA	1.2	92.14			Carbon disulphide	IIC	1.0	76.13				
Triethylamine			IIA	1.2	53.15			Hydrogen	IIC	4.0	2.02				



**OFF-SHORE  
APPLICATIONS**



**CHEMICAL  
INDUSTRY  
APPLICATIONS**

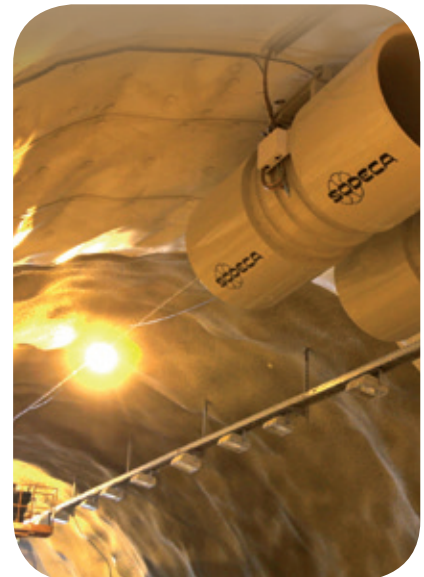

**MINING AND  
PUBLIC WORKS  
APPLICATIONS**

# HCDF HDF



**HCDF: ATEX Ex d-certified axial extractor fans with square frames**

**HDF: ATEX Ex d-certified axial extractor fans with circular frames**



HCDF



HDF

ATEX-certified, wall-mounted (HCDF) or circular (HDF) axial extractor fans with CEE ExII2G Ex d non-sparking motor for working in explosive atmospheres.

**Fan:**

- Cast aluminium rotor.
- Airflow direction from Motor to Impeller.
- Non-sparking cable gland included.
- HCDF: Support frame in sheet steel with aluminium strip in rotor zone, in accordance with standard EN-14986.
- HCDF: Anti-contact protective grille pursuant to standard UNE-EN ISO 12499.
- HDF: Support ring made of sheet steel with aluminium strip in rotor zone, in accordance with standard EN-14986.

**Motor:**

- ATE-certified, non-sparking Ex"d" IIBT4, class F motors with ball bearings and IP55 protection.
- Multi voltage motor, special design valid for 220/380V 60Hz, 254/440V 60Hz, 265/460V 60Hz, 277/480V 60Hz
- HDF: Operating temperature: -20 °C +40 °C.
- HCDF: Operating temperature: -20 °C +50 °C.



Marking: cEEx II 2G Ex d  
Notified Body: L.O.M.  
Identification no.:  
LOM3ATEX0157

**Finish:**

- Anti-corrosive finish, with non-ferric ATEX paint of polyester resin polymerised at 190 °C, previously degreased with phosphate-free nanotechnological treatment.

**On request:**

- Special windings for different voltages and frequencies.
- ATEX construction for different categories.
- Extractor fans with 2-speed motors.



Aluminium strips to prevent sparking in accordance with standard EN-14986:2006

**Order code**



HCDF: ATEX Ex D-certified axial extractor fans with square frames  
HDF: ATEX Ex D-certified axial extractor fans with square frames

Marking: cEEx II 2G c

Rotor diameter (cm)

Number of motor poles  
4=1680 r/min. 60 Hz  
6=1080 r/min. 60 Hz

T= Three-phase  
M=Single-phase

60Hz

**Technical characteristics**

Model	Speed (r/min)	Maximum admissible current (A)		Installed power (kW)	Maximum flow rate (m³/h)	Sound pressure level dB(A)	Approx. weight (kg)
		220-277	380-480V				
HCDF-25-4T	1644	0.78	0.45	0.09	890	51	6.5
HCDF-25-4M	1692	0.72		0.06	890	51	6.5
HCDF-31-4T	1644	0.78	0.45	0.09	1700	54	7.5
HCDF-31-4M	1692	0.72		0.06	1700	54	7.5
HCDF-35-4T	1644	0.78	0.45	0.09	2950	58	8.5
HCDF-35-4M	1692	0.72		0.06	2950	58	8.5
HCDF-40-4T	1704	1.3	0.75	0.25	4400	63	12.5
HCDF-40-4M	1680	3.25		0.25	4400	63	15
HCDF-45-4T	1704	1.3	0.75	0.25	6450	66	14.5
HCDF-45-4M	1680	3.25		0.25	6450	66	17
HCDF-45-6T	1110	0.95	0.55	0.12	5200	57	14.5
HCDF-50-4T	1668	1.73	1	0.37	8600	69	16.5
HCDF-50-6T	1104	1.56	0.9	0.18	6300	59	16
HCDF-56-4T	1668	3.08	1.78	0.55	10500	72	36.5
HCDF-56-6T	1092	1.59	0.92	0.25	8400	63	30.5
HDF-63-4T	1698	4.5	2.6	1.1	15100	76	49
HDF-63-6T	1086	2.37	1.37	0.37	12400	64	36.5
HDF-71-4T	1680	5.2	3	1.1	20000	79	52
HDF-71-6T	1080	3.29	1.9	0.55	13800	67	43
HDF-80-4T	1680	13.86	8	3	34100	83	76
HDF-80-6T	1092	5.89	3.4	1.1	20200	72	65.5
HDF-90-4T	1680	15.42	8.9	4	48200	89	87
HDF-90-6T	1104	7.45	4.3	1.5	30000	77	83

### Acoustic characteristics

The indicated values are determined by measuring the sound pressure level and sound power in dB(A) obtained in a free field at a distance equivalent to twice the size of the fan plus the rotor diameter, with a minimum of 1.5 m.

Sound power spectrum Lw(A) in dB(A) frequency band in [Hz]

Model	63	125	250	500	1000	2000	4000	8000	Model	63	125	250	500	1000	2000	4000	8000
25	22	37	56	55	56	55	50	41	63-4	52	66	85	85	86	84	80	71
31	25	40	59	58	59	58	53	44	63-6	40	54	73	73	74	72	68	59
35	29	44	63	62	63	62	57	48	71-4	56	76	84	89	91	88	81	70
40	34	49	68	67	68	67	62	53	71-6	44	64	72	77	79	76	69	58
45-4	37	52	71	70	71	70	65	56	80-4	60	80	88	93	95	92	85	74
45-6	28	43	62	61	62	61	56	47	80-6	49	69	77	82	84	81	74	63
50-4	43	57	76	76	77	75	71	62	90-4	67	88	95	100	103	99	92	81
56-4	46	60	79	79	80	78	74	65	90-6	55	76	83	88	91	87	80	69
56-6	37	51	70	70	71	69	65	56									

### Dimensions mm

#### HCDF 25...50

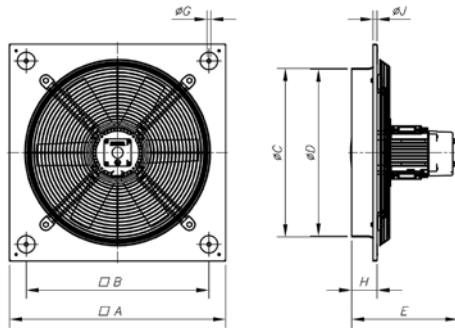

#### HCDF 56

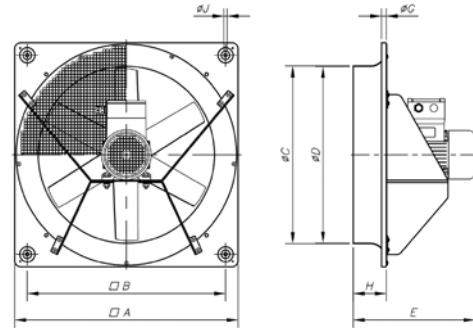

Model	A	B	∅C	∅D	E	G	H	∅I	∅J
HCDF-25-4T	330	275	262	260	275	11	56	110	8.5
HCDF-25-4M	330	275	262	260	275	11	56	110	8.5
HCDF-31-4T	400	336	310.5	308	285	11	65	110	10.5
HCDF-31-4M	400	336	310.5	308	285	11	65	110	10.5
HCDF-35-4T	465	390	362.5	360	296	11	76	110	10.5
HCDF-35-4M	465	390	362.5	360	296	11	76	110	10.5
HCDF-40-4T	532	452	412.5	410	335	11	98	136	10.5
HCDF-40-4M	532	452	412.5	410	335	11	98	136	10.5
HCDF-45-4T	596	504	462.5	460	331	11	105	136	10.5
HCDF-45-4M	596	504	462.5	460	331	11	105	136	10.5
HCDF-45-6T	596	504	462.5	460	338	11	105	136	10.5
HCDF-50-4T	665	562	516.5	514	345	11	115	136	10.5
HCDF-56-4T	710	630	563	560	397	15	115	-	10.5
HCDF-56-6T	710	630	563	560	386	15	115	-	10.5

#### HDF

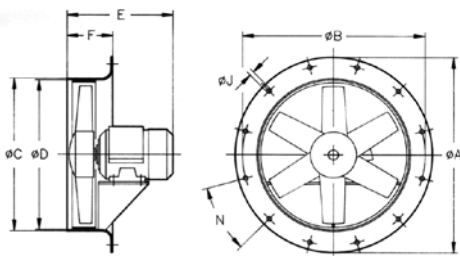

Model	∅A	∅B	∅C	D	E	F	∅J	N
HDF-63-4T	730	690	645	640	370	150	12	12x30°
HDF-63-6T	730	690	645	640	330	150	12	12x30°
HDF-71-4T	810	770	715	710	349	150	12	16x22°30'
HDF-71-6T	810	770	715	710	323	150	12	16x22°30'
HDF-80-4T	900	860	805	800	421	180	12	16x22°30'
HDF-80-6T	900	860	805	800	371	180	12	16x22°30'
HDF-90-4T	1015	970	906	900	457	180	15	16x22°30'
HDF-90-6T	1015	970	906	900	415	180	15	16x22°30'

**Characteristic curves**

Q= Flow rate in m<sup>3</sup>/h, m<sup>3</sup>/s and cfm.

Pe= Static pressure in mmH<sub>2</sub>O, Pa and inwg.

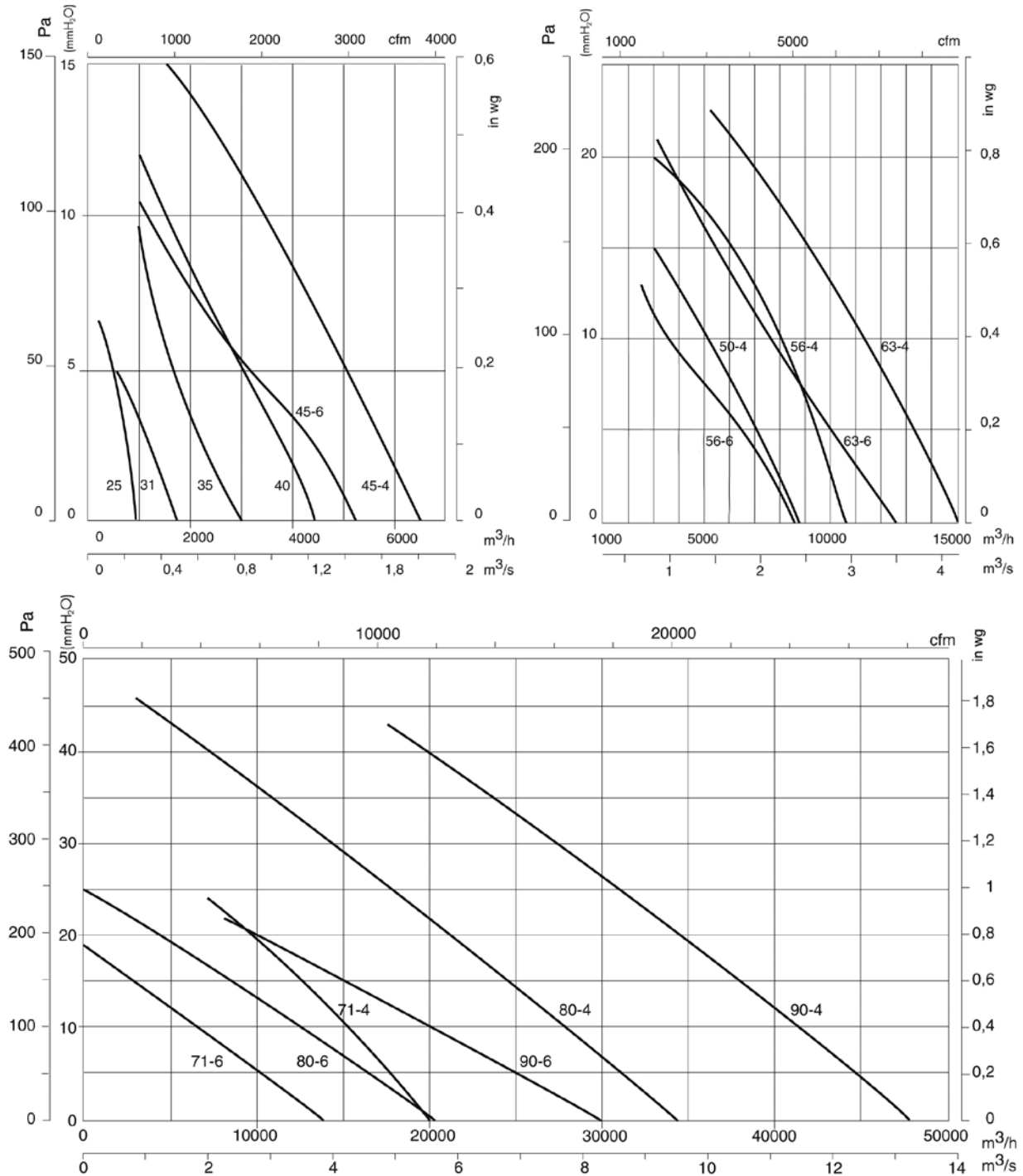

**Accessories**



INT

VSD3/A-RFT  
VSD1/A-RFM

CUADROS

P

R

RI

S

# HCH/ATEX HCT/ATEX



HCH/ATEX



HCT/ATEX

**HCH/ATEX: Extremely robust, ATEX-certified, wall-mounted axial extractor fans**

**HCT/ATEX: Extremely robust, ATEX-certified, tubular axial extractor fans**

ATEX-certified circular axial (HCH) or tubular (HCT) extractor fans with CEE ExII2G Ex e, CEE ExII2G Ex d, Ex tc, or Ex tb explosion-proof, non-sparking motors for operating in explosive atmospheres.

#### Fan:

- HCH/ATEX: Support ring made of sheet steel with aluminium strip in rotor zone, in accordance with standard EN-14986.
- HCT/ATEX: Tubular casing made of sheet steel with aluminium strip in rotor zone, in accordance with standard EN-14986.
- Cast aluminium rotor.
- With built-in inspection hatch (HCT).
- Airflow direction from Motor to Impeller.

#### Motor:

- ATEX-certified, Ex e explosion-proof, Ex d, Ex tc or Ex tb non-sparking class F motors with ball bearings
- Multi voltage motor, special design valid for 220/380V 60Hz, 254/440V 60Hz, 265/460V 60Hz, 277/480V 60Hz
- Operating temperature: -20 °C +40 °C.



Ex "e" marking:  $\text{CE} \text{Ex} \text{II 2G Ex e}$   
 Ex "d" marking:  $\text{CE} \text{Ex} \text{II 2G Ex d}$   
 Ex tc marking:  $\text{CE} \text{Ex} \text{II 3D Ex tc}$   
 Ex tb marking:  $\text{CE} \text{Ex} \text{II 2D Ex tb}$   
 Notified Body: L.O.M.  
 Identification no.: LOM3ATEX0157

#### Finish:

- Anti-corrosive finish, with non-ferric ATEX paint of polyester resin polymerised at 190 °C, previously degreased with phosphate-free nanotechnological treatment.

#### On request:

- Motors with built-in PTC.
- Special windings for different voltages and frequencies.
- ATEX construction for different categories.
- Extractor fans with 2-speed motors.
- Single-phase, Ex d non-sparking motors.

### Order code

**HCT/ATEX** — **56** — **4T** — **1.5** — **Ex-e** — **60Hz**

HCH: Wall-mounted axial extractor fans  
 HCT: Tubular axial extractor fans

Rotor diameter (cm) Number of motor poles  
 2=3500 r/min. 60 Hz  
 4=1680 r/min. 60 Hz  
 6=1080 r/min. 60 Hz

T= Three-phase  
 Motor power (hp)

Ex-e: marking:  $\text{CE} \text{Ex} \text{II 2G Ex e IIB T3}$   
 Ex "d" marking:  $\text{CE} \text{Ex} \text{II 2G Ex d IIB T5}$   
 Ex tc marking:  $\text{CE} \text{Ex} \text{II 3D Ex tc}$   
 Ex tb marking:  $\text{CE} \text{Ex} \text{II 2D Ex tb}$

#### Marking:

$\text{CE} \text{Ex} \text{II 2G c}$   
 $\text{CE} \text{Ex} \text{II 2D c}$   
 $\text{CE} \text{Ex} \text{II 3D c}$



60Hz

## Technical characteristics

Model	Speed (r/min)	Maximum current current (A)		Installed power (kW)	Maximum flow rate (m <sup>3</sup> /h)	Sound pressure level dB(A)	Approx. weight with motor (kg)	
		220-277V	380-480V				Ex-e	Ex-d
HCH/ATEX HCT/ATEX 35-2T	3360	2.08	1.20	0.37	5750	77	13	23
HCH/ATEX HCT/ATEX 35-4T	1728	1.28	0.74	0.12	3100	59	12	19
HCH/ATEX HCT/ATEX 40-2T-1.5	3480	4.50	2.60	1.1	8750	84	27	40
HCH/ATEX HCT/ATEX 40-4T-0.33	1740	2.08	1.20	0.25	5100	64	21	30
HCT/ATEX 45-2T-2	3480	6.24	3.60	1.5	10300	86	30	49
HCT/ATEX 45-2T-3	3480	8.66	5.00	2.2	12800	88	33	54
HCH/ATEX HCT/ATEX 45-4T-0.5	1740	2.60	1.50	0.37	7100	68	25	33
HCT/ATEX 50-4T-0,75	1740	2.94	1.70	0.55	10300	70	27	41
HCH/ATEX HCT/ATEX 56-4T-0,75	1740	2.94	1.70	0.55	11000	72	32	46
HCH/ATEX HCT/ATEX 56-4T-1	1740	3.81	2.20	0.75	12900	73	34	47
HCH/ATEX HCT/ATEX 56-4T-1.5	1740	5.20	3.00	1.1	14000	74	36	55
HCH/ATEX HCT/ATEX 56-4T-2	1740	6.93	4.00	1.5	15300	75	39	59
HCH/ATEX HCT/ATEX 56-6T-0.33	1140	2.42	1.40	0.25	8400	61	31	39
HCH/ATEX HCT/ATEX 56-6T-0,5	1140	2.77	1.60	0.37	9300	61	34	43
HCH/ATEX HCT/ATEX 56-6T-0,75	1140	3.46	2.00	0.55	10000	62	34	47
HCH/ATEX HCT/ATEX 63-4T-1	1740	3.81	2.20	0.75	14100	73	43	56
HCH/ATEX HCT/ATEX 63-4T-1,5	1740	5.20	3.00	1.1	17000	74	45	64
HCH/ATEX HCT/ATEX 63-4T-2	1740	6.93	4.00	1.5	18900	75	48	68
HCH/ATEX HCT/ATEX 63-4T-3	1740	9.01	5.20	2.2	22000	76	53	76
HCH/ATEX HCT/ATEX 63-4T-4	1740	12.30	7.10	3	25200	77	56	79
HCH/ATEX HCT/ATEX 63-6T-0,5	1140	2.77	1.60	0.37	12000	64	43	52
HCH/ATEX HCT/ATEX 63-6T-0,75	1140	3.46	2.00	0.55	12600	65	43	56
HCH/ATEX HCT/ATEX 63-6T-1	1140	4.16	2.40	0.75	13800	66	45	64
HCH/ATEX HCT/ATEX 71-4T-1,5	1740	5.20	3.00	1.1	19900	78	51	70
HCH/ATEX HCT/ATEX 71-4T-2	1740	6.93	4.00	1.5	21000	79	54	74
HCH/ATEX HCT/ATEX 71-4T-3	1740	9.01	5.20	2.2	24000	81	60	83
HCH/ATEX HCT/ATEX 71-4T-4	1740	12.30	7.10	3	29400	82	63	86
HCH/ATEX HCT/ATEX 71-6T-0,75	1140	3.46	2.00	0.55	15000	67	49	62
HCH/ATEX HCT/ATEX 71-6T-1	1140	4.16	2.40	0.75	17200	68	51	70
HCH/ATEX HCT/ATEX 71-6T-1,5	1140	5.89	3.40	1.1	21100	69	54	75
HCH/ATEX HCT/ATEX 80-4T-3	1740	9.01	5.20	2.2	29500	82	69	92
HCH/ATEX HCT/ATEX 80-4T-4	1740	12.30	7.10	3	37000	83	72	95
HCH/ATEX HCT/ATEX 80-4T-5,5	1740	15.76	9.10	4	40500	84	74	98
HCH/ATEX HCT/ATEX 80-6T-1	1140	4.16	2.40	0.75	23000	71	60	79
HCH/ATEX HCT/ATEX 80-6T-1,5	1140	5.89	3.40	1.1	26000	72	63	84
HCH/ATEX HCT/ATEX 80-6T-2	1140	7.62	4.40	1.5	29700	73	71	95
HCH/ATEX HCT/ATEX 80-6T-3	1140	9.35	5.40	2.2	33500	74	74	98
HCH/ATEX HCT/ATEX 90-4T-4	1740	12.30	7.10	3	40000	87	87	110
HCH/ATEX HCT/ATEX 90-4T-5,5	1740	15.76	9.10	4	46500	89	90	114
HCH/ATEX HCT/ATEX 90-4T-7,5	1740		12.00	5.5	51000	91	103	142
HCH/ATEX HCT/ATEX 90-4T-10	1140		16.30	7.5	54700	92	111	145
HCH/ATEX HCT/ATEX 90-6T-2	1140	7.62	4.40	1.5	34300	77	86	110
HCH/ATEX HCT/ATEX 90-6T-3	1140	9.35	5.40	2.2	38000	78	90	114
HCH/ATEX HCT/ATEX 90-6T-4	1740	14.72	8.50	3	42400	79	102	142
HCH/ATEX HCT/ATEX 100-4T-7,5	1740		12.00	5.5	54000	92	115	154
HCH/ATEX HCT/ATEX 100-4T-10	1740		16.30	7.5	63000	93	122	156
HCH/ATEX HCT/ATEX 100-4T-15	1740		23.80	11	68000	94	159	256
HCH/ATEX HCT/ATEX 100-4T-20	1140		30.60	15	72000	95	178	279
HCH/ATEX HCT/ATEX 100-6T-3	1140	9.35	5.40	2.2	43000	82	101	125
HCH/ATEX HCT/ATEX 100-6T-4	1140	14.72	8.50	3	47000	83	113	153
HCH/ATEX HCT/ATEX 100-6T-5,5	1740	18.88	10.90	4	53000	84	120	156

Dimensions mm

HCH/ATEX

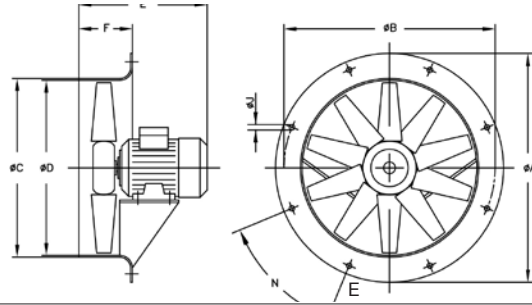

Model	ØA	ØB	ØC	ØD	0.16	0.33	0.5	0.75	1	1.5	2	3	4	5.5	7.5	10	15	20	F	ØJ	N
HCH-35-2	425	395	358	355	--	--	285	--	--	--	--	--	--	--	--	--	--	--	110	10	8x45°
HCH-35-4	425	395	358	355	257	--	--	--	--	--	--	--	--	--	--	--	--	--	110	10	8x45°
HCH-40-2	490	450	414	410	--	--	--	--	314	--	--	--	--	--	--	--	--	--	120	12	8x45°
HCH-40-4	490	450	414	410	--	305	--	--	--	--	--	--	--	--	--	--	--	--	120	12	8x45°
HCH-45-4	540	500	464	460	--	--	295	--	--	--	--	--	--	--	--	--	--	--	120	12	8x45°
HCH-45-6	540	500	464	460	--	295	--	--	--	--	--	--	--	--	--	--	--	--	120	12	8x45°
HCH-56-4	660	620	564	560	--	--	316	316	330	354	--	--	--	--	--	--	--	--	120	12	12x30°
HCH-56-6	660	620	564	560	--	298	316	316	--	--	--	--	--	--	--	--	--	--	120	12	12x30°
HCH-63-4	730	690	645	640	--	--	--	--	332	340	366	420	420	--	--	--	--	--	150	12	12x30°
HCH-63-6	730	690	645	640	--	--	332	332	340	--	--	--	--	--	--	--	--	--	150	12	12x30°
HCH-71-4	810	770	715	710	--	--	--	--	334	360	430	430	--	--	--	--	--	--	150	12	16x22°30'
HCH-71-6	810	770	715	710	--	--	--	323	334	360	--	--	--	--	--	--	--	--	150	12	16x22°30'
HCH-80-4	900	860	805	800	--	--	--	--	--	--	425	425	445	--	--	--	--	--	180	12	16x22°30'
HCH-80-6	900	860	805	800	--	--	--	--	360	386	425	445	--	--	--	--	--	--	180	12	16x22°30'
HCH-90-4	1015	970	906	900	--	--	--	--	--	--	--	436	430	465	465	--	--	--	180	12	16x22°30'
HCH-90-6	1015	970	906	900	--	--	--	--	--	436	430	465	--	--	--	--	--	--	180	12	16x22°30'
HCH-100-4	1115	1070	1006	1000	--	--	--	--	--	--	--	--	--	480	503	612	612	200	15	16x22°30'	
HCH-100-6	1115	1070	1006	1000	--	--	--	--	--	--	440	503	503	--	--	--	--	200	15	16x22°30'	

Measurements correspond to the Ex "e" version

HCT/ATEX

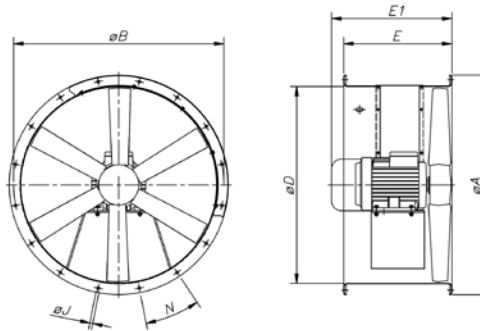

Model	ØA	ØB	D	E	E1	ØJ	N	Model	ØA	ØB	D	E	E1	ØJ	N
HCT-35-2T/ATEX	425	395	355	280	306	10	8x45°	HCT-71-4T-4/ATEX	810	770	710	500	500	12	16x22°30'
HCT-35-4T/ATEX	425	395	355	280	322	10	8x45°	HCT-71-6T-0.75/ATEX	810	770	710	430	430	12	16x22°30'
HCT-40-2T-1.5/ATEX	490	450	410	400	400	12	8x45°	HCT-71-6T-1/ATEX	810	770	710	500	442	12	16x22°30'
HCT-40-4T-0.33/ATEX	490	450	410	400	400	12	8x45°	HCT-71-6T-1.5/ATEX	810	770	710	500	442	12	16x22°30'
HCT-45-2T-2/ATEX	540	500	460	400	422	12	8x45°	HCT-80-4T-3/ATEX	900	860	800	500	500	12	16x22°30'
HCT-45-2T-3/ATEX	540	500	460	400	422	12	8x45°	HCT-80-4T-4/ATEX	900	860	800	500	500	12	16x22°30'
HCT-45-4T-0.5/ATEX	540	500	460	400	400	12	8x45°	HCT-80-4T-5.5/ATEX	900	860	800	500	519	12	16x22°30'
HCT-50-4T-0.75/ATEX	600	560	514	400	400	12	12x30°	HCT-80-6T-1/ATEX	900	860	800	500	500	12	16x22°30'
HCT-56-4T-0.75/ATEX	660	620	560	400	400	12	12x30°	HCT-80-6T-1.5/ATEX	900	860	800	500	500	12	16x22°30'
HCT-56-4T-1/ATEX	660	620	560	400	400	12	12x30°	HCT-80-6T-2/ATEX	900	860	800	500	500	12	16x22°30'
HCT-56-4T-1.5/ATEX	660	620	560	400	422	12	12x30°	HCT-80-6T-3/ATEX	900	860	800	500	519	12	16x22°30'
HCT-56-4T-2/ATEX	660	620	560	400	422	12	12x30°	HCT-90-4T-4/ATEX	1015	970	900	600	600	15	16x22°30'
HCT-56-6T-0.33/ATEX	660	620	560	400	400	12	12x30°	HCT-90-4T-5.5/ATEX	1015	970	900	600	600	15	16x22°30'
HCT-56-6T-0.5/ATEX	660	620	560	400	400	12	12x30°	HCT-90-4T-7.5/ATEX	1015	970	900	600	636	15	16x22°30'
HCT-56-6T-0.75/ATEX	660	620	560	400	400	12	12x30°	HCT-90-4T-10/ATEX	1015	970	900	600	716	15	16x22°30'
HCT-63-4T-1/ATEX	730	690	640	400	400	12	12x30°	HCT-90-6T-2/ATEX	1015	970	900	600	600	15	16x22°30'
HCT-63-4T-1.5/ATEX	730	690	640	400	422	12	12x30°	HCT-90-6T-3/ATEX	1015	970	900	600	600	15	16x22°30'
HCT-63-4T-2/ATEX	730	690	640	400	422	12	12x30°	HCT-90-6T-4/ATEX	1015	970	900	600	636	15	16x22°30'
HCT-63-4T-3/ATEX	730	690	640	500	500	12	12x30°	HCT-100-4T-7.5/ATEX	1115	1070	1000	600	636	15	16x22°30'
HCT-63-4T-4/ATEX	730	690	640	500	500	12	12x30°	HCT-100-4T-10/ATEX	1115	1070	1000	600	716	15	16x22°30'
HCT-63-6T-0.5/ATEX	730	690	640	400	400	12	12x30°	HCT-100-4T-15/ATEX	1115	1070	1000	700	738	15	16x22°30'
HCT-63-6T-0.75/ATEX	730	690	640	400	400	12	12x30°	HCT-100-4T-20/ATEX	1115	1070	1000	700	738	15	16x22°30'
HCT-63-6T-1/ATEX	730	690	640	400	422	12	12x30°	HCT-100-6T-3/ATEX	1115	1070	1000	600	600	15	16x22°30'
HCT-71-4T-1.5/ATEX	810	770	710	430	442	12	16x22°30'	HCT-100-6T-4/ATEX	1115	1070	1000	600	636	15	16x22°30'
HCT-71-4T-2/ATEX	810	770	710	430	442	12	16x22°30'	HCT-100-6T-5.5/ATEX	1115	1070	1000	600	716	15	16x22°30'
HCT-71-4T-3/ATEX	810	770	710	500	500	12	16x22°30'								

Measurements correspond to the Ex "e" version

## Acoustic characteristics

The indicated values are determined by measuring the sound pressure level and sound power in dB(A) obtained in a free field at a distance equivalent to twice the size of the fan plus the rotor diameter, with a minimum of 1.5 m.

Sound power spectrum Lw(A) in dB(A) frequency band in [Hz]

Model	63	125	250	500	1000	2000	4000	8000	Model	63	125	250	500	1000	2000	4000	8000		
35-2T	77	48	63	82	81	82	81	76	73	82	59	79	87	92	94	91	84	73	
35-4T	59	30	45	64	63	64	63	58	49	71-6T-0.75	67	44	64	72	77	79	76	69	58
40-2T-1.5	84	55	70	89	88	89	88	83	74	71-6T-1	68	45	65	73	78	80	77	70	59
40-4T-0.33	64	35	50	69	68	69	68	63	54	71-6T-1.5	69	46	66	74	79	81	78	71	60
45-2T-2	86	51	68	80	88	93	93	89	82	80-4T-3	82	59	79	87	92	94	91	84	73
45-2T-3	88	53	70	82	90	95	95	91	84	80-4T-4	83	60	80	88	93	95	92	85	74
45-4T-0.5	68	33	50	62	70	75	75	71	64	80-4T-5.5	84	61	81	89	94	96	93	86	75
50-4T-0.75	70	37	54	67	74	79	80	75	68	80-6T-1	71	48	68	76	81	83	80	73	62
56-4T-0.75	72	47	67	75	80	82	79	72	61	80-6T-1.5	72	49	69	77	82	84	81	74	63
56-4T-1	73	48	68	76	81	83	80	73	62	80-6T-2	73	50	70	78	83	85	82	75	64
56-4T-1.5	74	49	69	77	82	84	81	74	63	80-6T-3	74	51	71	79	84	86	83	76	65
56-4T-2	75	50	70	78	83	85	82	75	64	90-4T-4	87	65	86	93	98	101	97	90	79
56-6T-0.33	61	36	56	64	69	71	68	61	50	90-4T-5.5	89	67	88	95	100	103	99	92	81
56-6T-0.5	61	36	56	64	69	71	68	61	50	90-4T-7.5	91	69	90	97	102	105	101	94	83
56-6T-0.75	62	37	57	65	70	72	69	62	51	90-4T-10	92	70	91	98	103	106	102	95	84
63-4T-1	73	50	70	78	83	85	82	75	64	90-6T-2	77	55	76	83	88	91	87	80	69
63-4T-1.5	74	51	71	79	84	86	83	76	65	90-6T-3	78	56	77	84	89	92	88	81	70
63-4T-2	75	52	72	80	85	87	84	77	66	90-6T-4	79	57	78	85	90	93	89	82	71
63-4T-3	76	53	73	81	86	88	85	78	67	100-4T-7.5	92	72	92	100	105	107	104	97	86
63-4T-4	77	54	74	82	87	89	86	79	68	100-4T-10	93	73	93	101	106	108	105	98	87
63-6T-0.5	64	41	61	69	74	76	73	66	55	100-4T-15	94	74	94	102	107	109	106	99	88
63-6T-0.75	65	42	62	70	75	77	74	67	56	100-4T-20	95	75	95	103	108	110	107	100	89
63-6T-1	66	43	63	71	76	78	75	68	57	100-6T-3	82	62	82	90	95	97	94	87	76
71-4T-1.5	78	55	75	83	88	90	87	80	69	100-6T-4	83	63	83	91	96	98	95	88	77
71-4T-2	79	56	76	84	89	91	88	81	70	100-6T-5.5	84	64	84	92	97	99	96	89	78
71-4T-3	81	58	78	86	91	93	90	83	72										

## Characteristic curves

See HCH and HCT series

## Accessories



INT

VSD3/A-RFT  
VSD1/A-RFM

CUADROS

P

R

RI

RT

BTUB

BAC

PS

S

# CMA/ATEX



## ATEX-certified medium pressure centrifugal extractor fans made of cast aluminium

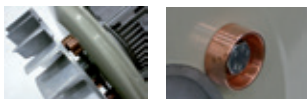

Centrifugal, medium pressure, single intake extractor fans with cast aluminium casing and impeller, for operation in explosive atmospheres.

### Fan:

- Cast aluminium casing.
- Cast aluminium impeller.

### Motor:

- ATEX-certified, class F, Ex "e" explosion-proof or Ex "d" non-sparking motors with ball bearings and IP55 protection.
- Multi voltage motor, special design valid for 220/380V 60Hz, 254/440V 60Hz, 265/460V 60Hz, 277/480V 60Hz.
- Maximum temperature of air to be carried: -20 °C +80 °C.



Ex "e" marking:  $\text{C}\text{E}\text{Ex}\text{II}2\text{G}\text{Ex}\text{e}$   
 Ex "d" marking:  $\text{C}\text{E}\text{Ex}\text{II}2\text{G}\text{Ex}\text{d}$   
 Ex tc marking:  $\text{C}\text{E}\text{Ex}\text{II}3\text{D}\text{Ex}\text{tc}$   
 Ex tb marking:  $\text{C}\text{E}\text{Ex}\text{II}2\text{D}\text{Ex}\text{tb}$   
**Notified Body: L.O.M.**  
**Identification no.: LOM04ATEX0007**

### Finish:

- Anti-corrosive finish, with non-ferric ATEX paint of polyester resin polymerised at 190 °C, previously degreased with phosphate-free nanotechnological treatment.

### On request:

- Motors with built-in PTC.
- Special windings for different voltages and frequencies.
- ATEX construction for different categories.

## Order code

**CMA/ATEX — 531 — 4T — 2 — Ex-e — 60Hz**

ATEX-certified medium pressure centrifugal extractor fans made of cast aluminium.

Impeller size

Number of motor poles  
2=3500 r/min. 60 Hz

T= Three-phase  
Motor power (hp)

Ex-e: marking:  
 $\text{C}\text{E}\text{Ex}\text{II}2\text{G}\text{Ex}\text{e}\text{IIB}\text{T}3$   
 Ex "d" marking:  
 $\text{C}\text{E}\text{Ex}\text{II}2\text{G}\text{Ex}\text{d}\text{IIB}\text{T}5$   
 Ex tc marking:  
 $\text{C}\text{E}\text{Ex}\text{II}3\text{D}\text{Ex}\text{tc}$   
 Ex tb marking:  
 $\text{C}\text{E}\text{Ex}\text{II}2\text{D}\text{Ex}\text{tb}$

### Marking:

$\text{C}\text{E}\text{Ex}\text{II}2\text{G}\text{c}$   
 $\text{C}\text{E}\text{Ex}\text{II}2\text{D}\text{c}$   
 $\text{C}\text{E}\text{Ex}\text{II}3\text{D}\text{c}$

**60Hz**

## Technical characteristics

Model	Speed (r/min)	Maximum current (A)		Installed power (kW)	Maximum flow rate (m <sup>3</sup> /h)	Sound pressure level dB(A)	Approx. weight with motor (kg)	
		220-277V	380-480V				Ex-e	Ex-d
CMA-324-2T/ATEX	3420	1.21	0.70	0.18	440	70	10	16
CMA-325-2T/ATEX	3336	1.73	1.00	0.25	600	73	12	19
CMA-426-2T/ATEX	3318	2.08	1.20	0.37	850	75	14	24
CMA-527-2T/ATEX	3360	2.94	1.70	0.55	1000	80	17	25
CMA-528-2T-1/ATEX	3336	3.46	2.00	0.75	1250	82	24	36
CMA-528-2T-1.5/ATEX	3420	4.50	2.60	1.1	1750	83	27	40
CMA-531-2T-1.5/ATEX	3456	4.50	2.60	1.1	1790	84	30	43
CMA-531-2T-2/ATEX	3420	6.24	3.60	1.5	2000	85	31	50
CMA-540-2T/ATEX	3468	6.24	3.60	1.5	2600	85	38	57
CMA-545-2T-3/ATEX	3408	8.66	5.00	2.2	2630	86	54	75
CMA-545-2T-4/ATEX	3456	12.12	7.00	3	3550	88	63	87

**Acoustic characteristics**

The indicated values are determined by measuring the sound pressure level and sound power in dB(A) obtained in a free field at a distance equivalent to twice the size of the fan plus the impeller diameter, with a minimum of 1.5 m.

Sound power spectrum Lw(A) in dB(A) frequency band in [Hz]

Model	Lp dB (A)	63	125	250	500	1000	2000	4000	8000	Model	Lp dB (A)	63	125	250	500	1000	2000	4000	8000
CMA-324-2T/ATEX	70	36	50	68	74	78	75	70	61	CMA-531-2T-1.5/ATEX	84	50	64	82	88	92	89	84	75
CMA-325-2T/ATEX	73	39	53	71	77	81	78	73	64	CMA-531-2T-2/ATEX	85	51	65	83	89	93	90	85	76
CMA-426-2T/ATEX	75	41	55	73	79	83	80	75	66	CMA-540-2T/ATEX	85	54	67	85	91	96	92	87	79
CMA-527-2T/ATEX	80	46	60	78	84	88	85	80	71	CMA-545-2T-3/ATEX	86	55	68	86	92	97	93	88	80
CMA-528-2T-1/ATEX	82	48	62	80	86	90	87	82	73	CMA-545-2T-4/ATEX	88	57	70	88	94	99	95	90	82
CMA-528-2T-1.5/ATEX	83	49	63	81	87	91	88	83	74										

**Dimensions mm**

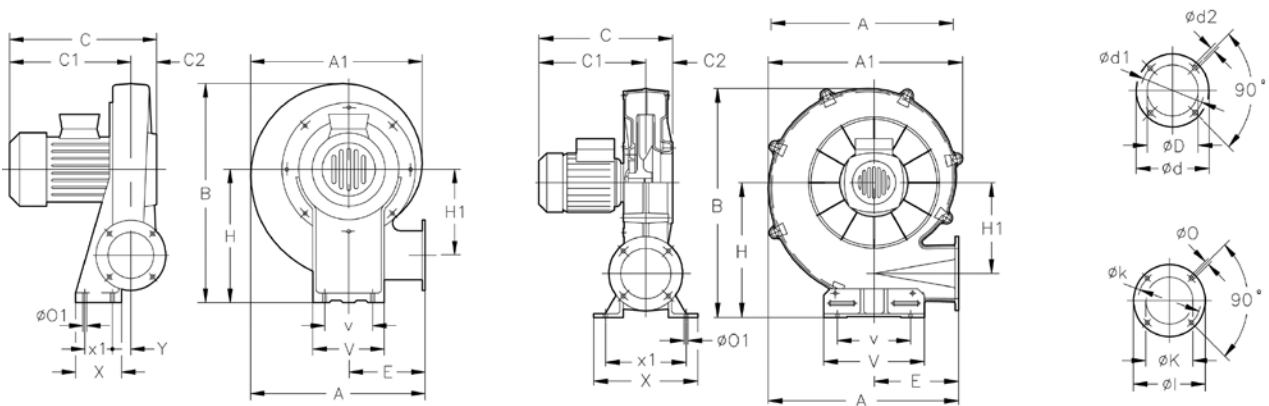

Model	Ex-"e"			Ex-"d"			C2	øD	ød	ød1	ød2	E	H	H1	øl	øK	øk	øO	øO1	V	v	X	x1	Y	
	A	A1	B	C	C1	C																			C1
CMA-324-2T/ATEX	311	302	356	263	225	288	250	38	80	130	112	M5	145	205	145	108	62	90	7	9	173	125	90	60	20
CMA-325-2T/ATEX	335	328	399	266	226	291	251	40	94	140	122	M6	155	235	152	120	80	102	7	9	180	145	110	80	20
CMA-426-2T/ATEX	354	344	412	293	253	316	276	40	117	155	132	M6	162	240	163	140	90	119	7	13	210	160	105	65	26
CMA-527-2T/ATEX	371	361	440	297	255	320	280	42	125	170	147	M6	168	260	170	155	100	129	7	13	220	170	120	80	20
CMA-528-2T-1/ATEX	401	395	488	340	292	342	294	51	116	190	162	M6	178	290	177	190	130	160	11	13	230	180	140	100	20
CMA-528-2T-1'5/ATEX	401	395	488	339	291	337	289	48	135	190	162	M6	178	290	177	190	130	160	11	13	230	180	140	100	20
CMA-531-2T-1'5/ATEX	440	434	537	340	292	342	294	50	160	215	180	M6	193	320	200	200	140	175	11	13	240	190	160	120	21
CMA-531-2T-2/ATEX	440	434	537	338	288	392	342	50	160	215	180	M6	193	320	200	200	140	175	11	13	240	190	160	120	21

Model	Ex-"e"			Ex-"d"			C2	øD	ød	ød1	ød2	E	H	H1	øl	øK	øk	øO	øO1	V	v	X	x1	Y	
	A	A1	B	C	C1	C																			C1
CMA-540-2T/ATEX	567	580	695	365	285	419	339	80	170	240	205	M10	252	415	270	220	150	190	13	11	336	218	374	240	-
CMA-545-2T-3/ATEX	651	646	776	438	323	467	352	115	180	255	220	M10	290	450	309	250	175	220	13	13	336	238	392	292	-
CMA-545-2T-4/ATEX	651	646	776	461	346	511	396	115	180	255	220	M10	290	450	309	250	175	220	13	13	336	238	392	292	-

**Characteristic curves**

See CMA series

**Accessories**



# CMP/ATEX



On request ATEX version construction in stainless steel

## ATEX-certified, medium pressure centrifugal extractor fans fitted with multi-blade impeller.

Centrifugal, medium pressure, single intake extractor fans with cast aluminium casing and impeller, for operation in explosive atmospheres.

### Fan:

- Sheet steel casing.
- Forward-curved impeller made of galvanised sheet steel.
- Non-sparking intake ring made of copper or aluminium.
- Maximum temperature of air to be carried: -20 °C +80 °C.

### Motor:

- ATEX-certified, class F, Ex "e" explosion-proof or Ex "d" non-sparking motors with ball bearings and IP55 protection.
- Multi voltage motor, special design valid for 220/380V 60Hz, 254/440V 60Hz, 265/460V 60Hz, 277/480V 60Hz.



Ex "e" marking: C<sup>Ⓒ</sup>Ex II 2G Ex e  
 Ex "d" marking: C<sup>Ⓒ</sup>Ex II 2G Ex d  
 Notified Body: **L.O.M.**  
 Ex tc marking: C<sup>Ⓒ</sup>Ex II 3D Ex tc  
 Ex tb marking: C<sup>Ⓒ</sup>Ex II 2D Ex tb  
 Identification no.:  
**LOM04ATEX0007**

### Finish:

- Anti-corrosive finish, with non-ferric ATEX paint of polyester resin polymerised at 190 °C, previously degreased with phosphate-free nanotechnological treatment.

### On request:

- Motors with built-in PTC.
- Special windings for different voltages and frequencies.
- ATEX construction for different categories.
- Construction entirely of stainless steel.

## Order code

**CMP/ATEX — 1128 — 2T — 5.5 — Ex-e — 60Hz**

ATEX-certified, medium pressure centrifugal extractor fans fitted with multi-blade impeller.

Impeller size

Number of motor poles  
 2=3500 r/min. 60 Hz  
 4=1680 r/min. 60 Hz

T= Three-phase

Motor power (hp)

Ex-e: marking:  
 C<sup>Ⓒ</sup>Ex II 2G Ex e IIB T3  
 Ex "d" marking:  
 C<sup>Ⓒ</sup>Ex II 2G Ex d IIB T5  
 Ex tc marking:  
 C<sup>Ⓒ</sup>Ex II 3D Ex tc  
 Ex tb marking:  
 C<sup>Ⓒ</sup>Ex II 2D Ex tb

### Marking:

C<sup>Ⓒ</sup>Ex II 2G c  
 C<sup>Ⓒ</sup>Ex II 2D c  
 C<sup>Ⓒ</sup>Ex II 3D c

## Technical characteristics

**60Hz**

Model	Speed (r/min)	Maximum current (A)		Installed power (kW)	Maximum flow rate (m³/h)	Sound pressure level dB(A)	Approx. weight with motor (kg)	
		220-277V	380-480V				Ex-e	Ex-d
CMP-616-2T/ATEX	3288	2.94	1.70	0.55	1380	69	9	19
CMP-616-4T/ATEX	1680	0.65	0.38	0.09	850	61	9	16
CMP-620-2T/ATEX	3288	2.08	1.20	0.37	765	68	11	21
CMP-620-4T/ATEX	1650	0.65	0.38	0.09	810	61	9	16
CMP-718-2T/ATEX	3426	3.46	2.00	0.75	1485	70	14	26
CMP-718-4T/ATEX	1692	2.08	1.20	0.25	1280	63	11	20
CMP-820-2T/ATEX	3414	4.50	2.60	1.10	1950	73	18	31
CMP-820-4T/ATEX	1620	2.08	1.20	0.25	1670	66	12	21
CMP-922-2T-1.5/ATEX	3414	4.50	2.60	1.10	1650	70	23	36
CMP-922-2T-2/ATEX	3432	6.24	3.60	1.50	2010	71	24	43
CMP-922-2T-3/ATEX	3456	8.66	5.00	2.20	2600	74	27	48
CMP-922-4T/ATEX	1674	2.94	1.70	0.55	2450	66	20	34
CMP-1025-2T-3/ATEX	3456	8.66	5.00	2.20	2100	73	29	50
CMP-1025-2T-4/ATEX	3474	12.12	7.00	3.00	2830	77	34	58
CMP-1025-4T/ATEX	1692	5.20	3.00	1.10	3400	70	27	46
CMP-1128-2T-4/ATEX	3474	12.12	7.00	3.00	2220	77	37	61
CMP-1128-2T-5.5/ATEX	3480	15.42	8.90	4.00	3210	81	41	62
CMP-1128-4T/ATEX	1704	9.01	5.20	2.20	5000	74	37	60
CMP-1231-4T-3/ATEX	1704	9.01	5.20	2.20	4740	73	46	69
CMP-1231-4T-4/ATEX	1704	12.30	7.10	3.00	5910	75	49	72
CMP-1231-4T-5.5/ATEX	1728	15.76	9.10	4.00	6850	77	53	77

**Technical characteristics**

Model	Speed (r/min)	Maximum current (A)		Installed power (kW)	Maximum flow rate (m³/h)	Sound pressure level dB(A)	Approx. weight with motor (kg)	
		220-277V	380-480V				Ex-e	Ex-d
CMP-1435-4T-4/ATEX	1704	12.30	7.10	3.00	5560	76	54	77
CMP-1435-4T-5.5/ATEX	1728	15.76	9.10	4.00	6260	78	61	85
CMP-1435-4T-7.5/ATEX	1746		12.00	5.50	7210	80	74	113
CMP-1640-4T-5.5/ATEX	1728	15.76	9.10	4.00	7000	77	79	103
CMP-1640-4T-7.5/ATEX	1746		12.00	5.50	8035	80	92	131
CMP-1640-4T-10/ATEX	1746		16.30	7.50	9710	82	100	134
CMP-1845-4T-7.5/ATEX	1746		12.00	5.50	8000	82	94	133
CMP-1845-4T-10/ATEX	1746		16.30	7.50	10000	85	102	136
CMP-2050-4T-10/ATEX	1746		16.30	7.50	9000	83	135	169
CMP-2050-4T-15/ATEX	1752		23.80	11.00	12525	87	162	259
CMP-2050-4T-20/ATEX	1746		30.60	15.00	16500	89	181	282

**Acoustic characteristics**

The indicated values are determined by measuring the sound pressure level and sound power in dB(A) obtained in a free field at a distance equivalent to twice the size of the fan plus the impeller diameter, with a minimum of 1.5 m.

Sound power spectrum Lw(A) in dB(A) frequency band in [Hz]

Model	Lp dB (A)	63	125	250	500	1000	2000	4000	8000	Model	Lp dB (A)	63	125	250	500	1000	2000	4000	8000
CMP-616-2T/ATEX	69	44	54	65	72	76	73	71	64	CMP-1128-2T-5.5/ATEX	81	56	66	77	84	88	85	83	76
CMP-616-4T/ATEX	61	36	46	57	64	68	65	63	56	CMP-1128-4T/ATEX	74	49	59	70	77	81	78	76	69
CMP-620-2T/ATEX	68	43	53	64	71	75	72	70	63	CMP-1231-4T-3/ATEX	73	51	60	71	78	82	80	78	71
CMP-620-4T/ATEX	61	36	46	57	64	68	65	63	56	CMP-1231-4T-4/ATEX	75	53	62	73	80	84	82	80	73
CMP-718-2T/ATEX	70	45	55	66	73	77	74	72	65	CMP-1231-4T-5.5/ATEX	77	55	64	75	82	86	84	82	75
CMP-718-4T/ATEX	63	38	48	59	66	70	67	65	58	CMP-1435-4T-4/ATEX	76	54	63	74	81	85	83	81	74
CMP-820-2T/ATEX	73	48	58	69	76	80	77	75	68	CMP-1435-4T-5.5/ATEX	78	56	65	76	83	87	85	83	76
CMP-820-4T/ATEX	66	41	51	62	69	73	70	68	61	CMP-1435-4T-7.5/ATEX	80	58	67	78	85	89	87	85	78
CMP-922-2T-1.5/ATEX	70	45	55	66	73	77	74	72	65	CMP-1640-4T-5.5/ATEX	77	55	64	75	82	86	84	82	75
CMP-922-2T-2/ATEX	71	46	56	67	74	78	75	73	66	CMP-1640-4T-7.5/ATEX	80	58	67	78	85	89	87	85	78
CMP-922-2T-3/ATEX	74	49	59	70	77	81	78	76	69	CMP-1640-4T-10/ATEX	82	60	69	80	87	91	89	87	80
CMP-922-4T/ATEX	66	41	51	62	69	73	70	68	61	CMP-1845-4T-7.5/ATEX	82	61	71	82	89	93	91	89	81
CMP-1025-2T-3/ATEX	73	48	58	69	76	80	77	75	68	CMP-1845-4T-10/ATEX	85	64	74	85	92	96	94	92	84
CMP-1025-2T-4/ATEX	77	52	62	73	80	84	81	79	72	CMP-2050-4T-10/ATEX	83	62	72	83	90	94	92	90	82
CMP-1025-4T/ATEX	70	45	55	66	73	77	74	72	65	CMP-2050-4T-15/ATEX	87	66	76	87	94	98	96	94	86
CMP-1128-2T-4/ATEX	77	52	62	73	80	84	81	79	72	CMP-2050-4T-20/ATEX	89	68	78	89	96	100	98	96	88

**Dimensions mm**

**CMP-616...820**

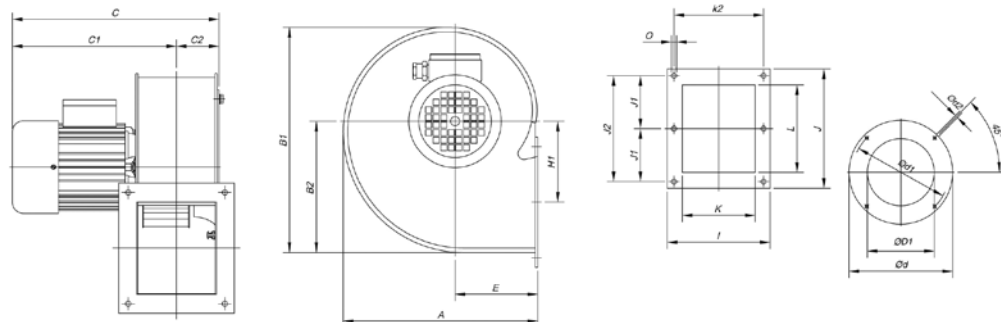

Model	A	B1	B2	C	C1	C2	øD1	ød	ød1	ød2	E	H1	I	J	J1	J2	K	k2	L	øO
CMP-616-2T/ATEX	258	297	173.5	375	318	56	160	204	180	M.6	110	105.5	153	172	-	147	103	128	125	7
CMP-616-4T/ATEX	258	297	173.5	345	288	56	160	204	180	M.6	110	105.5	153	172	-	147	103	128	125	7
CMP-620-2T/ATEX	298	347	202.5	376	320	56	200	247	230	M.6	126	145.5	159	153	-	128	105	134	100	8
CMP-620-4T/ATEX	298	347	202.5	345	290	56	200	247	230	M.6	126	145.5	159	153	-	128	105	134	100	8
CMP-718-2T/ATEX	303.5	348	201	396	335	64	180	238	210	M.6	129.5	122	169	192	85	170	115	145	146	9
CMP-718-4T/ATEX	303.5	348	201	385	324	64	180	238	210	M.6	129.5	122	169	192	85	170	115	145	146	9
CMP-820-2T/ATEX	322	377	223	411	343	68	200	247	230	M.6	137.5	137	184	213	94.5	189	130	160	156	9
CMP-820-4T/ATEX	322	377	223	400	332	68	200	247	230	M.6	137.5	137	184	213	94.5	189	130	160	156	9

Dimensions mm

CMP-616...820

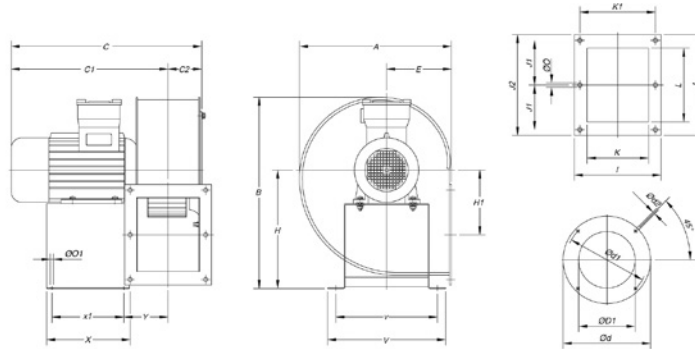

Model	A	B	C	C1	C2	øD1	ød	ød1	ød2	E	H	H1	I	J	J1	J2	K	k1	L	ø0	ø01	V	v	X	x1	Y
CMP (Ex-d)-616-2T	258	400	376	318.5	57.5	160	204	180	M.6	109.5	251	107	153	172	-	147	103	128	125	7	9	250	215	175	145	83.5
CMP (Ex-d)-616-4T	258	380	346	288.5	57.5	160	204	180	M.6	109.5	243	107	153	172	-	147	103	128	125	7	9	250	215	175	145	78.5
CMP (Ex-d)-620-2T	298	400	376	320	56	200	247	230	M.6	126	251	145.5	159	153	-	128	105	134	100	8	9	250	215	175	145	84.5
CMP (Ex-d)-620-4T	298	388	346	290	56	200	247	230	M.6	126	243	145.5	159	153	-	128	105	134	100	9	9	250	215	175	145	79.5
CMP (Ex-d)-718-2T	303.5	440	396	335	61	180	238	210	M.6	129.5	260	122	169	192	85	170	115	145	146	9	9	250	215	175	145	94.5
CMP (Ex-d)-718-4T	303.5	400	386	325	61	180	238	210	M.6	129.5	251	122	169	192	-	170	115	145	146	9	9	250	215	175	145	94.5
CMP (Ex-d)-820-2T	322	440	415	343.5	71.5	200	247	230	M.6	137.5	260	137	184	213	94.5	189	130	160	156	9	9	250	215	175	145	102
CMP (Ex-d)-820-4T	322	405	403	331.5	71.5	200	247	230	M.6	137.5	251	137	184	213	94.5	189	130	160	156	9	9	250	215	175	145	97

CMP-922...1231

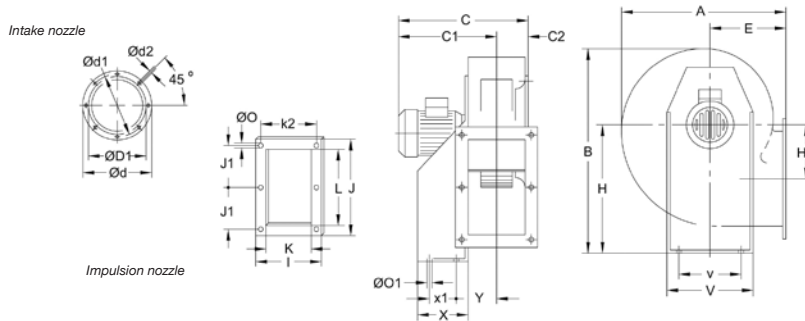

Model	Ex-"e"		Ex-"d"		C2	øD1*	ød	ød1	ød2	E	H	H1	I	J	J1	K	k2	L	ø0	ø01	V	v	X	x1	Y		
	A	B	C	C1																							
CMP-922-2T-1.5/ATEX	388.5	455	382	309	424	351	73.5	224	278	256	M.8	180	280	134	204	282.5	128	140	180	215	9.5	10.5	290	220	114	50	105
CMP-922-2T-2/ATEX	388.5	455	423.5	350	430.5	357	73.5	224	278	256	M.8	180	280	134	204	282.5	128	140	180	215	9.5	10.5	290	220	114	50	105
CMP-922-2T-3/ATEX	388.5	455	423.5	350	430.5	357	73.5	224	278	256	M.8	180	280	134	204	282.5	128	140	180	215	9.5	10.5	290	220	114	50	105
CMP-922-4T/ATEX	388.5	455	382.5	309	424	351	73.5	224	278	256	M.8	180	280	134	204	282.5	128	140	180	215	9.5	10.5	290	220	114	50	105
CMP-1025-2T-3/ATEX	427	503	456	370	466	380	86	250	305	282	M.8	197	310	144	229	312.5	145	165	205	250	9.5	12.5	315	228	134	74	115.5
CMP-1025-2T-4/ATEX	427	503	486	400	516	430	86	250	305	282	M.8	197	310	144	229	312.5	145	165	205	250	9.5	12.5	315	228	134	74	115.5
CMP-1025-4T/ATEX	427	503	456	370	466	380	86	250	305	282	M.8	197	310	144	229	312.5	145	165	205	250	9.5	12.5	315	228	134	74	115.5
CMP-1128-2T-4/ATEX	472	553	493.5	400	532.5	434	93.5	280	348	320	M.8	216	340	152	244	364	170	180	220	296.5	9.5	12.5	348	245	144	95	122.5
CMP-1128-2T-5.5/ATEX	472	553	553.5	451	553.5	451	93.5	280	348	320	M.8	216	340	152	244	364	170	180	220	296.5	9.5	12.5	348	245	144	95	122.5
CMP-1128-4T/ATEX	472	553	493.5	400	532.5	434	93.5	280	348	320	M.8	216	340	152	244	364	170	180	220	296.5	9.5	12.5	348	245	144	95	122.5
CMP-1231-4T-3/ATEX	526	630	520.5	417	547.5	444	103.5	315	382	354	M.8	238	390	179.5	264	382.5	180	200	240	320	11.5	13	382	322	183	140	126
CMP-1231-4T-4/ATEX	526	630	520.5	417	547.5	444	103.5	315	382	354	M.8	238	390	179.5	264	382.5	180	200	240	320	11.5	13	382	322	183	140	126
CMP-1231-4T-5.5/ATEX	526	630	543.5	440	576.5	434	103.5	315	382	354	M.8	238	390	179.5	264	382.5	180	200	240	320	11.5	13	382	322	183	140	126

\* Recommended nominal tube diameter



Dimensions mm

CMP-1435...2050

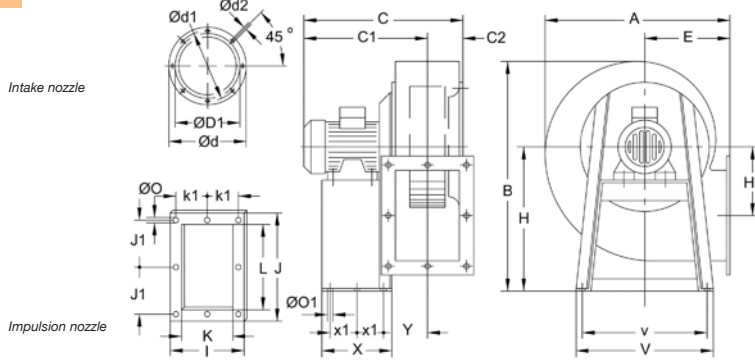

Model	A	B	Ex-"e"		Ex-"d"		C2	ØD1*	Ød	Ød1	Ød2	E	H	H1	I	J	J1	K	k1	L	Ø0	Ø01	V	v	X	x1	Y
			C	C1	C	C1																					
CMP-1435-4T-4/ATEX	573.5	715	527	409	577	459	118	355	422	394	M.8	250	445	242.5	292	342.5	159	228	133	280	11.5	12	456	420	333	136.5	150
CMP-1435-4T-5.5/ATEX	573.5	715	572	545	597	479	118	355	422	394	M.8	250	445	242.5	292	342.5	159	228	133	280	11.5	12	456	420	333	136.5	150
CMP-1435-4T-7.5/ATEX	573.5	715	610	492	670	552	118	355	422	394	M.8	250	445	242.5	292	342.5	159	228	133	280	11.5	12	456	420	333	136.5	150
CMP-1640-4T-5.5/ATEX	634	799	596	465	621	491	130	400	464	438	M.8	270	495	271	336	404	185	250	150	321	11.5	12	500	460	327	133.5	162.5
CMP-1640-4T-7.5/ATEX	634	799	634	504	693	563	130	400	464	438	M.8	270	495	271	336	404	185	250	150	321	11.5	12	500	460	327	133.5	162.5
CMP-1640-4T-10/ATEX	634	799	634	504	693	563	130	400	464	438	M.8	270	495	271	336	404	185	250	150	321	11.5	12	500	460	327	133.5	162.5
CMP-1845-4T-7.5/ATEX	711	901	668	521	727	580	147	450	515	485	M.8	302	560	305	370	444	202	284	164	361	11.5	12	538	502	340	140	179.5
CMP-1845-4T-10/ATEX	711	901	668	521	727	580	147	450	515	485	M.8	302	560	305	370	444	202	284	164	361	11.5	12	538	502	340	140	179.5
CMP-2050-4T-10/ATEX	797	987	700.5	538	759	596.5	162.5	500	565	535	M.10	345	610	313	411	544	250	315	182.5	451	11.5	12	653	615	435	188	196
CMP-2050-4T-15/ATEX	797	987	818.5	656	923.5	764.5	162.5	500	565	535	M.10	345	610	313	411	544	250	315	182.5	451	11.5	12	653	615	435	188	196
CMP-2050-4T-20/ATEX	797	987	859.5	697	923.5	764.5	162.5	500	565	535	M.10	345	610	313	411	544	250	315	182.5	451	11.5	12	653	615	435	188	196

\* Recommended nominal tube diameter

Characteristic curves

See CMP series

Orientation

Standard supply LG 270

Positions LG 180 and RD 180 on request with special anchoring measurements.



Accessories



# CMR/ATEX

**Extremely robust centrifugal medium pressure extractor fans fitted with reaction impeller, and with ATEX certification**



Extremely robust medium pressure, single inlet centrifugal fans for operation in explosive atmospheres.

#### Fan:

- Sheet steel casing.
- Impeller with reaction blades in extremely robust sheet steel.
- Non-sparking intake ring made of copper or aluminium.

#### Motor:

- ATEX-certified, class F, Ex "e" explosion-proof or Ex "d" non-sparking motors with ball bearings and IP55 protection.
- Multi voltage motor, special design valid for 220/380V 60Hz, 254/440V 60Hz, 265/460V 60Hz, 277/480V 60Hz.
- Maximum temperature of air to be carried: -20 °C +80 °C.



Ex "e" marking: C<sup>Ⓒ</sup> (Ex) II 2G Ex e  
 Ex "d" marking: C<sup>Ⓒ</sup> (Ex) II 2G Ex d  
 Ex tc marking: C<sup>Ⓒ</sup> (Ex) II 3D Ex tc  
 Ex tb marking: C<sup>Ⓒ</sup> (Ex) II 2D Ex tb  
 Notified Body: **L.O.M.**  
 Identification no.:  
**LOM3ATEX147**

#### Finish:

- Anti-corrosive finish, with non-ferric ATEX paint of polyester resin polymerised at 190 °C, previously degreased with phosphate-free nanotechnological treatment.

#### On request:

- Motors with built-in PTC.
- Special windings for different voltages and frequencies.
- ATEX construction for different categories.
- Construction entirely of stainless steel.

### Order code

**CMR/ATEX — 1650 — 2T — 5.5 — DIP65 — 60Hz**

Extremely robust centrifugal medium pressure extractor fans fitted with reaction impeller, and with ATEX certification

#### Marking:

C<sup>Ⓒ</sup> (Ex) II 2G c  
 C<sup>Ⓒ</sup> (Ex) II 2D c  
 C<sup>Ⓒ</sup> (Ex) II 3D c

Impeller size

Number of motor poles

2=3500 r/min. 60 Hz  
 4=1680 r/min. 60 Hz  
 6=1080 r/min. 60 Hz

T= Three-phase

Motor power (hp)

Ex-e marking:

C<sup>Ⓒ</sup> (Ex) II 2G Ex e IIB T3

Ex "d" marking:

C<sup>Ⓒ</sup> (Ex) II 2G Ex d IIB T5

Ex tc marking:

C<sup>Ⓒ</sup> (Ex) II 3D Ex tc

Ex tb marking:

C<sup>Ⓒ</sup> (Ex) II 2D Ex tb

### Technical characteristics

**60Hz**

Model	Speed (r/min)	Maximum current (A)		Installed power (kW)	Maximum flow rate (m <sup>3</sup> /h)	Sound pressure level dB(A)	Approx. weight with motor (kg)	
		220-277V	380-480V				Ex-e	Ex-d
CMR-1240-4T/ATEX	1745	3.81	2.20	0.75	5800	71	70	84
CMR-1445-2T/ATEX	3500		15.70	7.50	16500	87	141	163
CMR-1445-4T/ATEX	1750	5.20	3.00	1.10	8030	72	93	112
CMR-1650-2T/ATEX	3490		22.00	11.00	18850	89	178	258
CMR-1650-4T/ATEX	1730	6.93	4.00	1.50	10500	74	114	134
CMR-1650-6T/ATEX	1165	4.16	2.40	0.75	7410	64	111	130
CMR-1856-4T/ATEX	1745	12.30	7.10	3.00	15150	79	152	175
CMR-1856-6T/ATEX	1160	5.89	3.40	1.10	10050	70	145	166
CMR-2063-4T/ATEX	1750		12.00	5.50	24450	80	225	264
CMR-2063-6T/ATEX	1120	7.62	4.40	1.50	16100	71	209	233
CMR-2271-4T/ATEX	1760		23.80	11.00	34610	85	315	412
CMR-2271-6T/ATEX	1140	14.72	8.50	3.00	22750	76	280	320
CMR-2380-4T/ATEX	1680		42.00	22.00	48000	83	416	495
CMR-2380-6T/ATEX	1080		16.40	7.50	30000	75	363	441

**Acoustic characteristics**

The indicated values are determined by measuring the sound pressure level and sound power in dB(A) obtained in a free field at a distance equivalent to twice the size of the fan plus the impeller diameter, with a minimum of 1.5 m.

Sound power spectrum Lw(A) in dB(A) frequency band in [Hz]

Model	Lp dB (A)	63	125	250	500	1000	2000	4000	8000
CMR-1240-4T/ATEX	71	56	70	76	79	79	80	70	59
CMR-1445-2T/ATEX	87	73	85	83	95	93	97	99	89
CMR-1445-4T/ATEX	72	59	72	78	83	80	83	78	64
CMR-1650-2T/ATEX	89	73	81	85	99	97	99	99	88
CMR-1650-4T/ATEX	74	64	74	82	84	83	85	76	66
CMR-1650-6T/ATEX	64	53	65	72	77	73	69	62	54
CMR-1856-4T/ATEX	79	69	78	91	87	90	91	85	71

Model	Lp dB (A)	63	125	250	500	1000	2000	4000	8000
CMR-1856-6T/ATEX	70	61	69	81	83	80	81	71	60
CMR-2063-4T/ATEX	80	80	85	91	93	91	88	81	73
CMR-2063-6T/ATEX	71	69	70	82	82	81	83	73	63
CMR-2271-4T/ATEX	85	83	84	93	96	98	99	95	82
CMR-2271-6T/ATEX	76	73	73	87	86	90	90	79	68
CMR-2380-4T/ATEX	83	76	78	94	91	96	97	93	82
CMR-2380-6T/ATEX	75	68	70	86	83	88	89	85	74

**Dimensions mm**

**CMR-1240...2271**

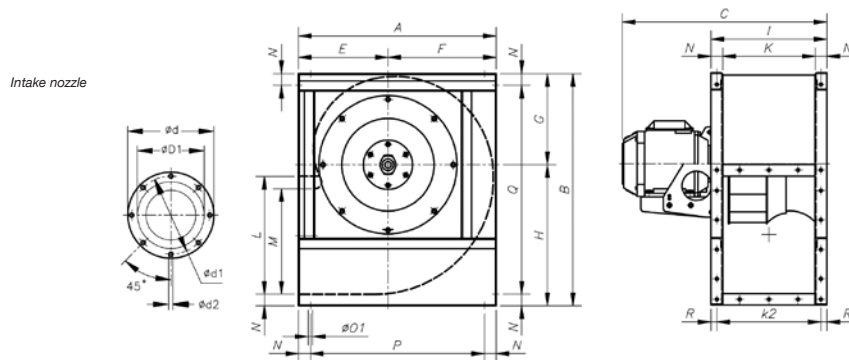

Ex-"e" Ex-"d"

Model	A	B	C	C	ØD1*	Ød	Ød1	Ød2	E	F	G	H	I	K	k2	L	M	N	Ø01	P	Q	R
CMR-1240-4T/ATEX	673	790	596	638	400	472	444	M.10	305	368	310	480	395	315	355	400	358	40	11	593	710	20
CMR-1445-2T/ATEX	765	880	774	857	450	522	494	M.10	350	415	339	541	445	355	403	450	404	45	11	675	790	21
CMR-1445-4T/ATEX	765	880	679	687	450	522	494	M.10	350	415	339	541	445	355	403	450	404	45	11	675	790	21
CMR-1650-2T/ATEX	832	970	945.5	1018	500	582	555	M.10	375	457	378	592	490	400	450	500	445	45	13	742	880	20
CMR-1650-4T/ATEX	832	970	724.5	724.5	500	582	555	M.10	375	457	378	592	490	400	450	500	445	45	13	742	880	20
CMR-1650-6T/ATEX	832	970	724.5	724.5	500	582	555	M.10	375	457	378	592	490	400	450	500	445	45	13	742	880	20
CMR-1856-4T/ATEX	925	1084	798	889	560	645	615	M.10	415	510	426	658	550	450	500	560	493	50	13	825	984	25
CMR-1856-6T/ATEX	925	1084	780.5	809	560	645	615	M.10	415	510	426	658	550	450	500	560	493	50	13	825	984	25
CMR-2063-4T/ATEX	1037	1218	937	1020	630	720	688	M.10	465	572	477	741	620	500	560	630	530	60	13	917	1098	30
CMR-2063-6T/ATEX	1037	1218	839	930	630	720	688	M.10	465	572	477	741	620	500	560	630	530	60	13	917	1098	30
CMR-2271-4T/ATEX	1173	1375	1129	1201	710	800	768	M.12	525	648	538	837	690	560	625	710	603	65	13	1043	1245	32.5
CMR-2271-6T/ATEX	1173	1375	973	1056	710	800	768	M.12	525	648	538	837	690	560	625	710	603	65	13	1043	1245	32.5

\* Recommended nominal tube diameter

**CMR-1240...2380**

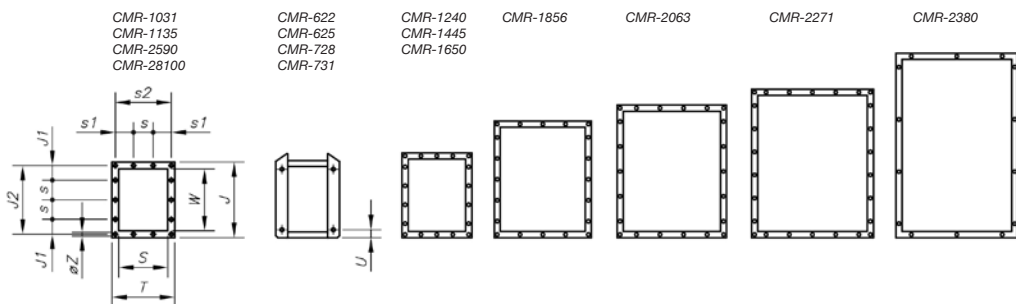

Model	T	J	J1	J2	S	s	s1	s2	W	Øz	U
CMR-1240	395	480	70	440	315	100	77.5	355	400	11	-
CMR-1445	445	540	99	498	355	100	102.5	403	450	11	-
CMR-1650	490	590	88	550	400	125	100	450	500	11	-
CMR-1856	550	660	55	610	450	125	125	500	560	13	-
CMR-2063	620	750	95	690	500	125	92.5	560	630	13	-
CMR-2271	690	840	75	775	560	125	62.5	625	710	13	-
CMR-2380	680	920	160	871	560	200	140	639	800	14	-

**Dimensions mm**

**CMR-2380**

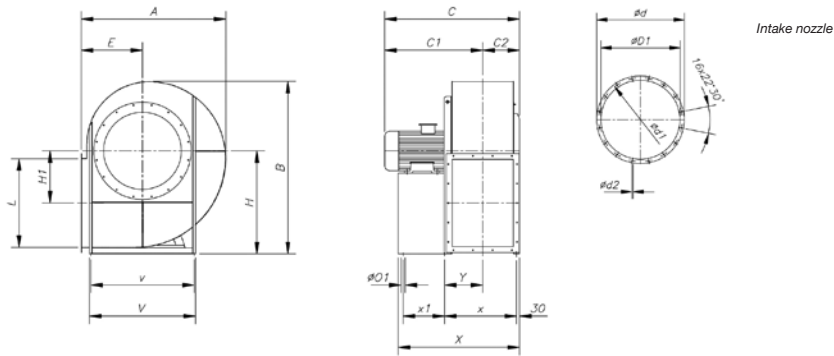

Model	Ex-"e"		Ex-"d"		C2	ØD1*	Ød	Ød1	Ød2	E	H	H1	L	Ø01	V	v	X	x	x1	Y
	A	B	C	C1																
CMR-2380-4T/ATEX	1350	1660	1019	733	286	808	906	861	11.5	560	1000	500	800	17	930	870	1102.5	667.5	370	352.5
CMR-2380-6T/ATEX	1350	1660	590	304	286	808	906	861	11.5	560	1000	500	800	17	930	870	1102.5	667.5	370	352.5

\* Recommended nominal pipe diameter

**Characteristic curves**

See CMR series

**Orientation**

Standard supply LG 270



**Accessories**



## HEAT RECOVERY UNITS • AIR FILTER AND TREATMENT UNITS

413

## RECUP



Configurable heat recovery units with cross-flow plates for horizontal (H) or vertical (V) installation

419

## SV/FILTER



Low-noise, in-line duct extractor fans with different filtering phases.

423

## UFR



Filter units acoustically insulated with sandwich panel

427

## UDT



Ventilation units with air treatment systems and direct drive motors

431

## UDTX



Belt-driven ventilation units with air treatment systems

437



# HEAT RECOVERY UNITS, AIR FILTER AND TREATMENT UNITS

Due to the international and EU objective of promoting improved energy efficiency in buildings, SODECA presents this new heat recovery units and Filter units catalogue, which is adapted to the strictest European standards, to offer solutions to all needs and achieve the required standard of efficiency in each building.

The teamwork of our engineering department, along with universities and technological centres, and the close cooperation of our customers has made it possible to find new solutions for current market needs, with a view to obtaining major improvements in energy efficiency.

The combination of its experience gained over decades of working with fans and the technology provided by the engineers employed in its different departments has allowed Sodeca to occupy a leading international position as a fan manufacturer.

## OUR OBJECTIVES

- Energy saving and the ensuing reduction in the use of natural resources.
- Energy efficiency improvement.
- Reduction in noise pollution.
- Environmental protection.
- Reduction in CO2 emissions.

In EU member states, air treatment units must comply with new requirements related to energy efficiency.

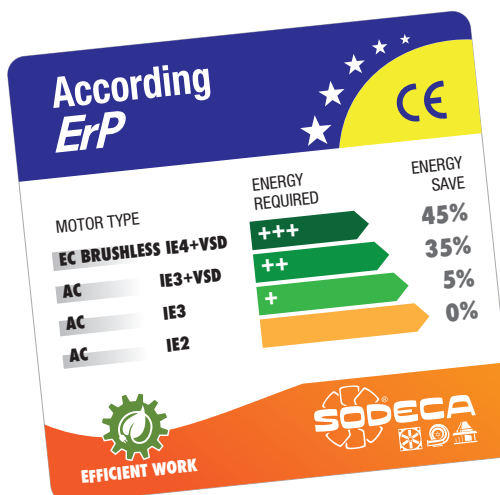
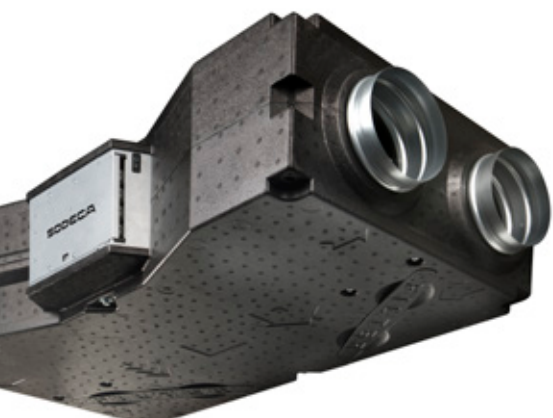

## HEAT RECOVERY UNITS



Heat recovery units function by means of a combination of two centrifugal fans, in which one extracts stale air from the interior of the premises and discharges it to the exterior, and the other pumps fresh air from the exterior to the interior of the premises. Both circuits cross each other but without mixing, and the heat from the discharged air is transferred to the fresh air from the exterior, heating it.

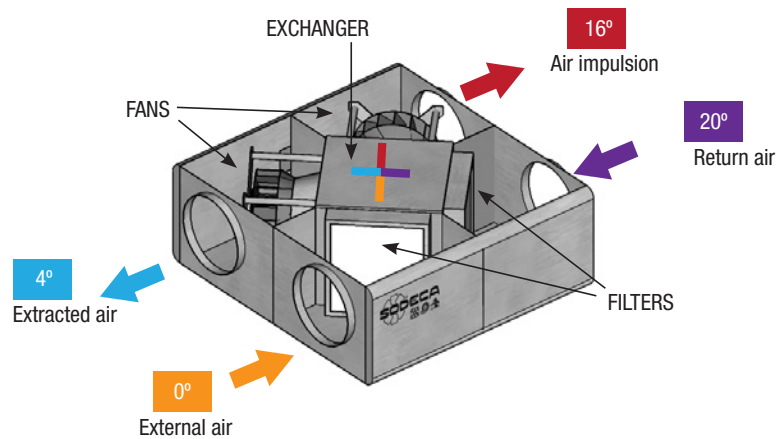

## FILTER UNITS



The Filter units remove particles from the air, guaranteeing its quality.

Filter units components

- Centrifugal fan in a closed box structure.
- Prefiltration and filtration phases.
- Filter status control elements: Manometers and pressure switches.
- Constant flow rate control elements.

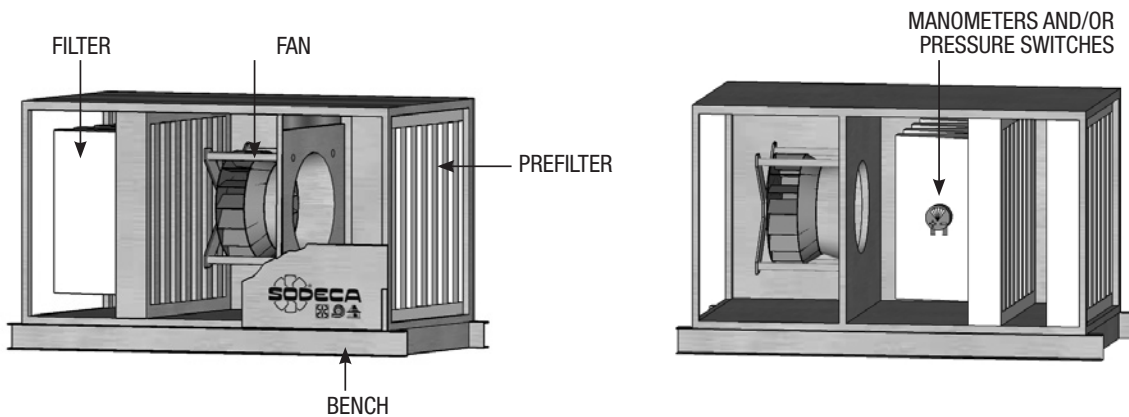

## FILTRATION PHASE POSITION

### HEAT RECOVERY UNITS

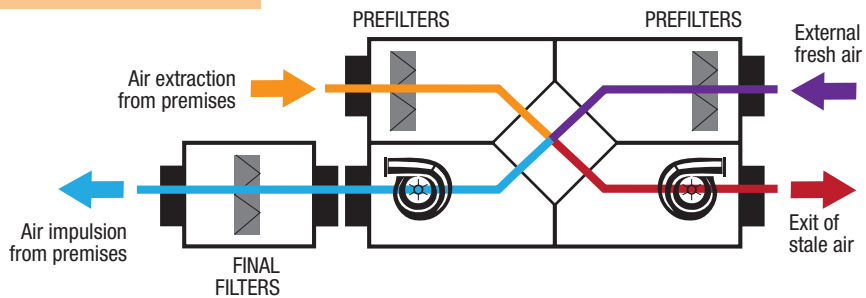

### FILTER UNITS

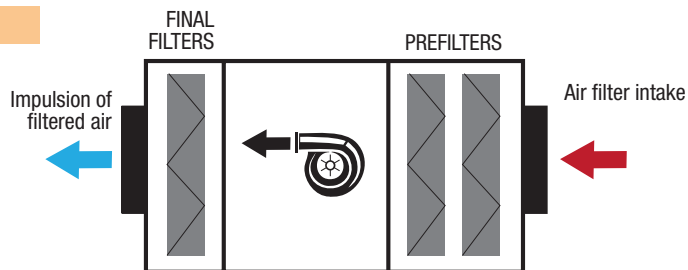

## TYPES OF INSTALLATION



### Wall-mounted

Household equipment for heat recovery in small rooms.



### In technical ceilings

Low-profile equipment with access to components through the side or base.

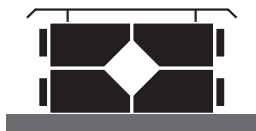

### On the roof

Equipment for outdoor operation, with lateral access to components. They may require accessories such as roofs, rain shields or other elements.



### In technical room

Compact equipment with lateral access to components. The most common case is equipment with nozzles installed at the top.



## HEAT RECOVERY UNITS

The heat exchanger component in the recovery unit transfers heat from the stale air extraction circuit to the external clean air supply circuit. The greater the exchanger thermal efficiency, the less the need to supply additional air conditioning. Main types of exchangers, depending on their construction:



### Cross-flow panels

- . 50-70% thermal efficiency.
- . With no leaks between air circuits.
- . Compact and economical.



### Cross-flow panels

- . 80-95% thermal efficiency.
- . With no leaks between air circuits.
- . Smaller equipment required.

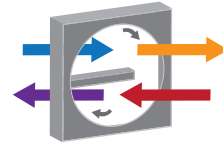

### Rotating

- . 70-85% thermal efficiency.
- . Compact.
- . Can operate in BY-PASS mode.

Heat exchangers may be the heat-sensitive or the enthalpy type. Enthalpy heat exchangers recover heat and moisture, which increases their efficiency, but they require regular cleaning to ensure safe operation.

## MOTORISATIONS

Types of motor that can be installed in the equipment fans:

- . AC: Conventional high efficiency motors. They may have different speeds or speed drives, depending on the models or accessories.
- . EC: High efficiency motors with proportional control capacities.

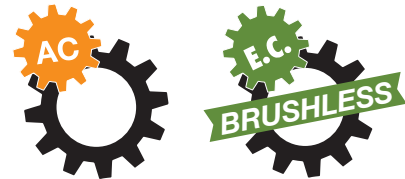

## THERMAL BY-PASS

The BY-PASS device diverts the air flow and prevents it from passing through the heat recovery unit and the thermal exchange of the unit.

It has the following benefits:

- . Rapid cooling of air in premises (free cooling). Enables the rapid cooling of the premises when the temperature inside them is too high and the external temperature is more appropriate for the need.
- . Protection from freezing (only in plate heat exchangers). Reduces the risk of freezing in winter.
- . In rotating heat exchanger equipment, the BY-PASS function is achieved by stopping the rotation of the rotor.
- . In plate heat exchanger equipment, the BY-PASS provides an alternate flow passage through the equipment.

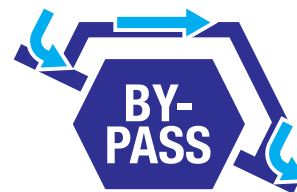

## AIR CONDITIONING OPTIONS

Some types of equipment have versions or accessories with coils that heat or cool the air supply. This is very common in heat exchangers, but this may also occur in filter units. The most habitual options are the following:



**Environmental version**  
With no air conditioning supply.



**Electric coil version**  
Heat supplied by electric coils.



**Water coil version**  
Thermal treatment supplied cold or hot water coils.

## AUTOMATIC CONTROL

In heat recovery units, automatic control may offer a wide range of functions, depending on the equipment series or models. The most important are:

- Time programming.
- Number of speeds and variable speed drive (VSD) option.
- Flow rate control based on CO2 levels or air pressure in duct.
- Connection of equipment to a centralised control system (BMS), Usually by means of a MODBUS RTU protocol.



In the case of filter units, supply of the following elements:

- Manometers and pressure switches that make it possible to know when the filters must be replaced.
- Accessories that regulate the fan, to stabilise the flow rate and increase the life of the filters.

## FILTERS

Filters retain particles that affect air quality and they must be replaced after a certain length of time. The load loss of the filters gradually increases.

Some pieces of equipment have load loss control elements that optimise filter replacement.

- Pressure fittings: Small air fittings that enable the detection of load loss in filtering phases.
- Differential manometer: Visual detection of load loss during the filtering phase.
- Pressure switch: Pressure switch that switches an electric circuit depending on the filter load loss reading.

Each filtration phase has one or more filters with the same efficiency, depending on the needs of each application. Depending on its configuration, the equipment may have:

- A pre-filter phase to guarantee the correct operation of the equipment. Depending on the system requirements, the efficiencies may be: G4, F6, F7.
- Final filter phases to ensure the quality of the air supplied to the premises, in which the efficiencies are usually: F6, F7, F8, F9, CA (activated carbon gases) or even HEPA, based on the IDA/ODA category.

**F6**

**F6 + F8**

**F7**

**F7 + F9**

**G4 + F6**

# RECUP



## Configurable heat recovery units with cross-flow panels, for horizontal (H) or vertical (V) installation



RECUP-H



RECUP-V

### Characteristics:

- Plate heat exchanger made of aluminium panels with an efficiency of between 52%-55%.
- Possibility of configuration with different nozzle positions.
- Built-in filters, classes G4, F6 and F6+F8. Other combinations available on request.
- Box made of galvanised steel with built-in acoustic insulation.

### Construction:

- Galvanised sheet steel structure.
- Entry and exit nozzles with water-tight gaskets.
- Interchangeable nozzles.

- Access door for ease of maintenance and cleaning.

### Versions:

- Horizontal (H) or vertical (V).
- Environmental: Air renewal without heat supply (S).

### On request:

- Electric: Heat supplied by electric coils (EB).
- Water coil: Heat supplied by water coils (WB).
- Adiabatic module.



### Order code

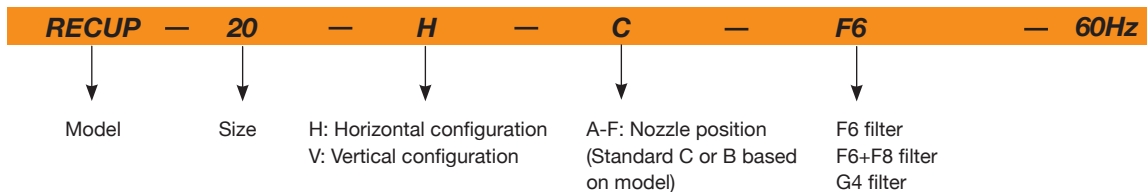

### Technical characteristics

Model	Speed (r/min)	Voltage (V)	Current (A)	Motor power (W)	Maximum flow rate F6(m³/h)	Thermal efficiency (%)	Irradiated SPL dB(A)	Filter EN 779	Weight (kg)
RECUP-12-H	1710	1x220	2x2.00	2x450	1300	52	53	G4, F6, F6+F8	67
RECUP-20-H	1620	1x220	2x2.00	2x450	2050	52	48	G4, F6, F6+F8	86
RECUP-20-V	1620	1x220	2x2.00	2x450	2050	52	48	G4, F6, F6+F8	86
RECUP-30-H	1500	1x220	2x5.40	2x600	3150	54	52	G4, F6, F6+F8	112
RECUP-30-V	1500	1x220	2x5.40	2x600	3150	54	52	G4, F6, F6+F8	112
RECUP-40-H	1080	3x380	2x3.60	2x1100	4250	55	46	G4, F6, F6+F8	167
RECUP-40-V	1080	3x380	2x3.60	2x1100	4250	55	46	G4, F6, F6+F8	167
RECUP-50-H	1536	3x380	2x3.50	2x1500	5350	53	54	G4, F6, F6+F8	182
RECUP-50-V	1536	3x380	2x3.50	2x1500	5350	53	54	G4, F6, F6+F8	182
RECUP-60-H	1740	3x380	2x4.83	2x2200	6150	50	56	G4, F6, F6+F8	205
RECUP-60-V	1740	3x380	2x4.83	2x2200	6150	50	56	G4, F6, F6+F8	205

**Configurations (horizontal version)**

Standard supply C configuration. Except model 12, B configuration.

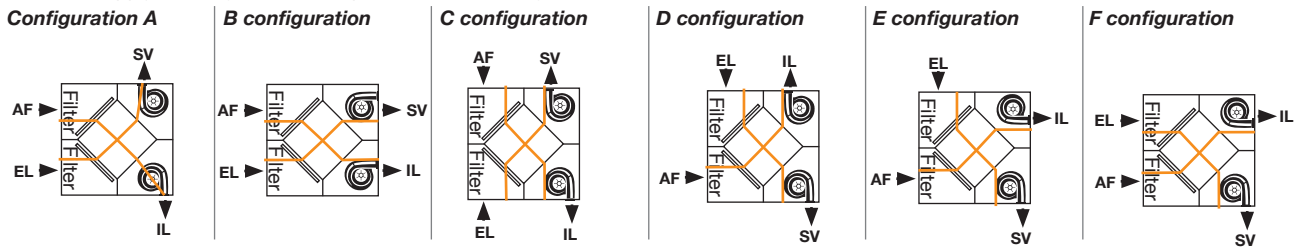

AF: External fresh air / IL: Impulsion of air to premises / SV: Exit of stale air / EL: Air extraction from premises

**Dimensions mm**

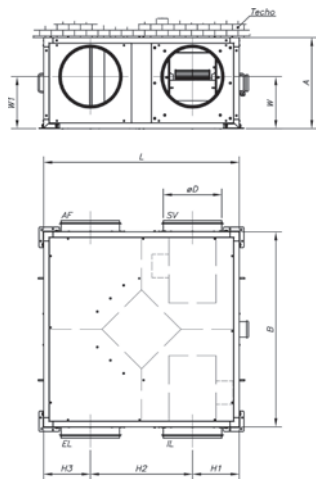

**RECUP H F6**

Model	A	B	L	øD	H1	H2	H3	W	W1
RECUP-12-H	415	1000	1000	315	260.4	479.2	260.4	207.5	207.5
RECUP-20-H	490	1050	1050	315	251	548	251	280	280
RECUP-30-H	590	1100	1200	315	266	668	266	350	350
RECUP-40-H	670	1500	1500	450	350	800	350	368	368
RECUP-50/60-H	850	1500	1700	450	351.5	997	351.5	424.5	424.5



**RECUP H F6+F8**

Model	A	B	B1	L	øD	H1	H2	H3	W	W1	W2	W3
RECUP-12-H	415	1000	1525	1000	315	260.4	479.2	260.4	207.5	207.5	207.5	207.5
RECUP-20-H	490	1050	1575	1050	315	251	548	251	250	280	280	280
RECUP-30-H	590	1100	1625	1200	315	266	668	266	320	350	350	350
RECUP-40-H	670	1500	2025	1500	450	350	800	350	368	368	368	368
RECUP-50/60-H	849	1500	2025	1700	450	351.5	997	351.5	424.5	424.5	424.5	424.5

Dimensions mm

RECUP V F6

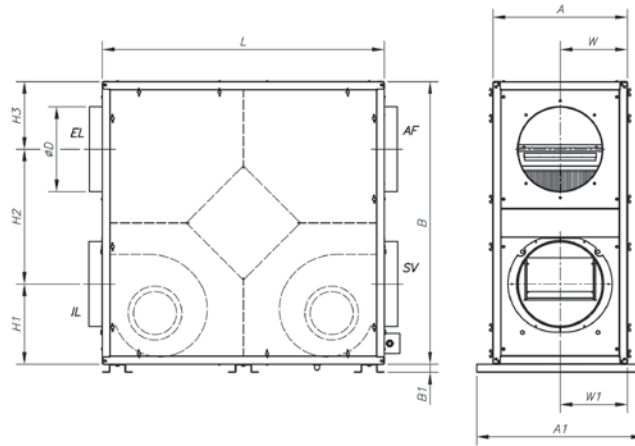

Model	A	A1	B	B1	L	øD	H1	H2	H3	W	W1
RECUP-20-V	500	620	1050	30	1050	315	298	501	251	250	250
RECUP-30-V	600	720	1202	30	1102	315	384	548	270	300	300
RECUP-40-V	670	790	1500	30	1500	450	391.5	739	369.5	334	335
RECUP-50-V	805	925	1700	30	1500	450	441	912	347	402.5	402.5
RECUP-60-V	805	925	1700	30	1500	450	441	912	347	402.5	402.5

RECUP V F6+F8

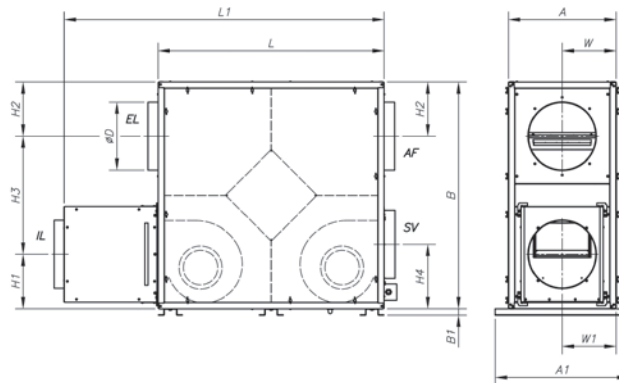

Model	A	A1	B	B1	L	L1	øD	H1	H2	H3	H4	W	W1
RECUP-20-V	500	620	1050	30	1050	1487	315	252	501	251	298	250	250
RECUP-30-V	600	720	1202	30	1102	1540	315	335	548	270	384	300	300
RECUP-40-V	670	790	1500	30	1500	1933	450	369.5	739	369.5	391.5	334	335
RECUP-50-V	805	925	1700	30	1500	1933	450	403.5	912	347	441	402.5	402.5
RECUP-60-V	805	925	1700	30	1500	1933	450	403.5	912	347	441	402.5	402.5

**Acoustic characteristics**

The indicated values are determined by measuring the sound power level in dB(A) obtained in a free field at a distance of no less than 1.5 m from the equipment.

Sound power spectrum Lw(A) in dB(A) per Hz frequency band

Model	63	125	250	500	1000	2000	4000	8000
RECUP-12	54	56	49	52	54	50	45	38
RECUP-20	49	51	44	47	49	45	40	33
RECUP-30	54	56	50	51	48	43	35	31

Model	63	125	250	500	1000	2000	4000	8000
RECUP-40	49	51	43	37	36	30	29	15
RECUP-50	57	59	50	44	42	36	37	22
RECUP-60	59	61	52	46	44	38	39	24

**Characteristic curves**

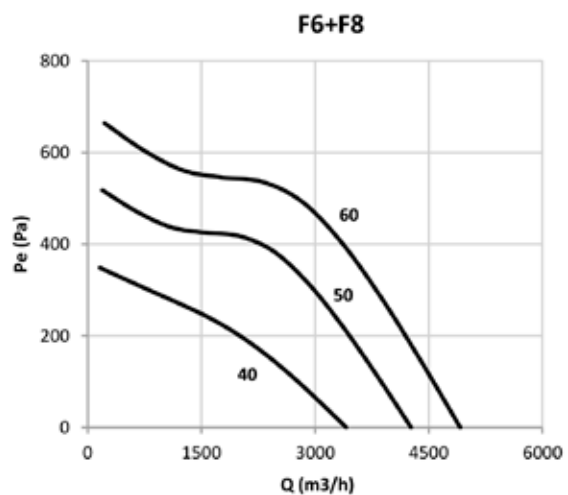
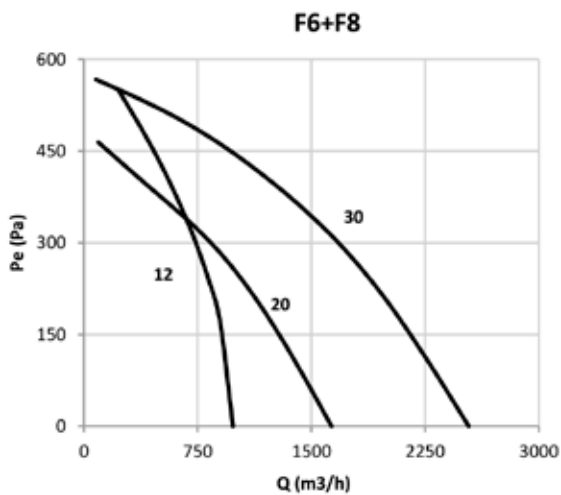
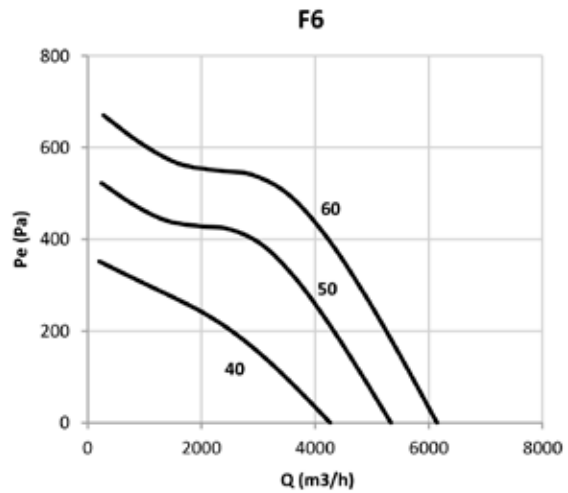
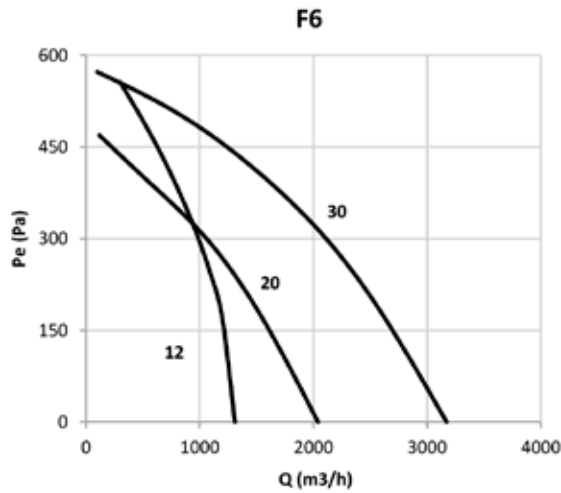

**Accessories**



# SV/FILTER

*Low-noise, in-line duct extractor fans with different filtering phases*



G4 + F6

F6 + F8

F7 + F9



#### Characteristics:

- Acoustic casing coated with phonoabsorbent material.
- Standardised intake and impulsion flanges allowing for easy installation in ducts.
- G4 + F6, F6 + F8 and F7 + F9 filters, depending on model.
- Inspection and cleaning chambers that are easy to access.

#### Construction:

- Galvanised sheet steel casing.
- Impeller with reaction blades, except models 125 and 150 with multi-blade impeller. Supplied with 4 support feet to facilitate mounting.
- Access door for ease of maintenance and cleaning.

#### Motor:

- External rotor motors with built-in thermal protector, class F, with ball bearings, IP54 protection.
- Single-phase 220V 60Hz Adjustable
- Maximum temperature of air to be carried +50 °C.

#### Finish:

- Anti-corrosive finish of polyester resin polymerised at 190 °C, previously degreased with phosphate-free nanotechnological treatment.

### Order code

**SV/FILTER — 200/H — F7+F9 — 60Hz**

Model

Size

Filter combination

### Technical characteristics

**60Hz**

Model	Speed (r/min)	Maximum admissible current (A) 220V	Installed power (kW)	Maximum flow rate			No. of pre-filters	No. of filters	Filter dimensions (mm)		Weight (kg)
				Filters (G4+F6)	Filters (F6+F8)	Filters (F7+F9)			Filters (G4)	Filters (F)	
SV/FILTER-125/H	2664	0.65	0.08	300	255	240	1	1	282x194x48	282x194x98	9.1
SV/FILTER-150/H	2640	1.25	0.17	445	385	360	1	1	334x216x48	334x216x98	12.3
SV/FILTER-200/H	1488	0.85	0.12	515	520	390	1	1	389x248x48	389x248x98	15.1
SV/FILTER-250/H	2856	0.95	0.14	660	560	525	1	1	414x267x48	414x267x98	17.8
SV/FILTER-315/H	1596	0.75	0.12	1035	850	790	1	1	513x344x48	513x344x98	26.4
SV/FILTER-350/H	1536	0.95	0.14	1550	1270	1180	1	1	602x385x48	602x385x98	36.3
SV/FILTER-400/H	1596	1.8	0.3	2050	1720	1600	1	1	660x405x48	660x405x98	46.4

Dimensions mm

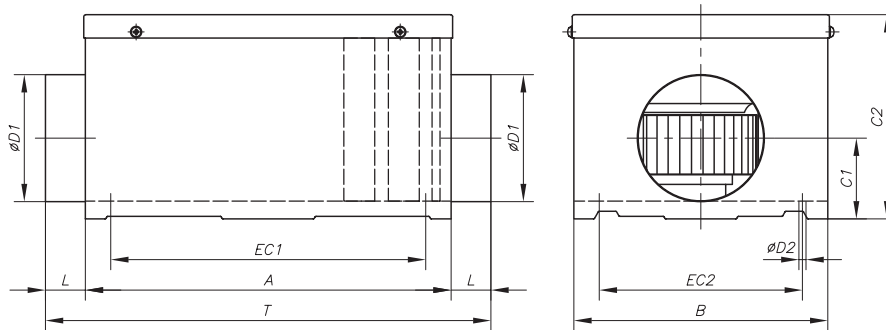

Model	A	B	C1	C2	Ø D1	L	Ø D2	EC1	EC2	T
SV/FILTER-125/H	657	290	80	222	125	36,5	7	607	240	730
SV/FILTER-150/H	700	340	92	244	150	36,5	7	650	290	773
SV/FILTER-200/H	775	395	117	273	200	36	7	725	345	847
SV/FILTER-250/H	775	395	140	293	250	50	7	725	345	875
SV/FILTER-315/H	860	520	175	371	315	48	8.5	809	469	956
SV/FILTER-350/H	960	610	200	410	355	48	8.5	909	564	1056
SV/FILTER-400/H	1035	670	219	455	400	38	8.5	984	624	1111

Characteristic curves

Equipment curve based on built-in filters **1** G4+F6 **2** F6+F8 **3** F7+F9

Static pressure      Dynamic pressure      Absorbed power

SV/FILTER 125/H

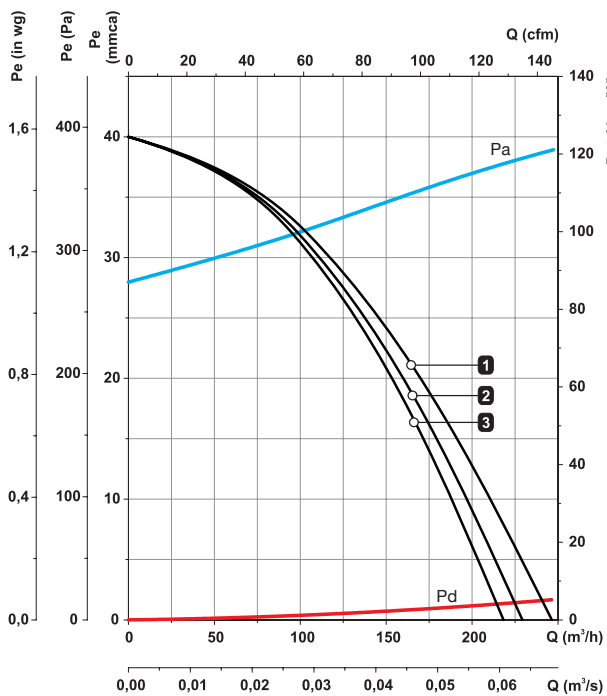

SV/FILTER 150/H

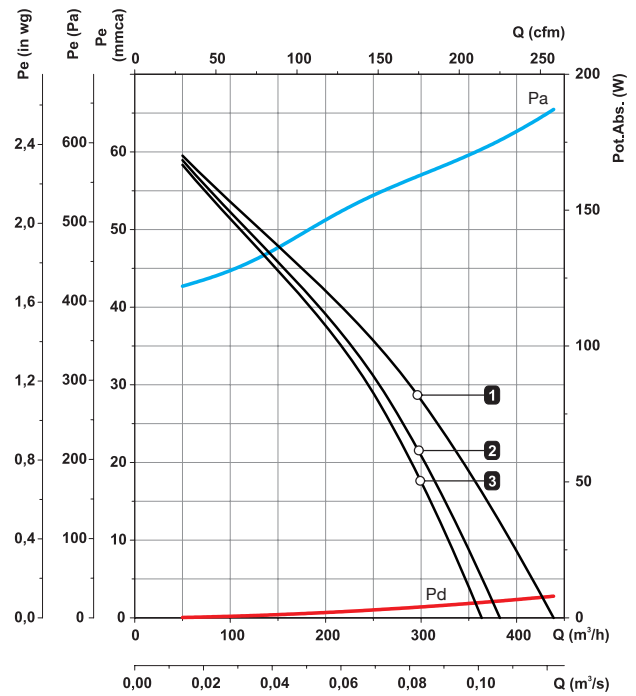



**Characteristic curves**

Equipment curve based on built-in filters **1** G4+F6 **2** F6+F8 **3** F7+F9

Static pressure                           Dynamic pressure                           Absorbed power                     

**SV/FILTER 200/H**

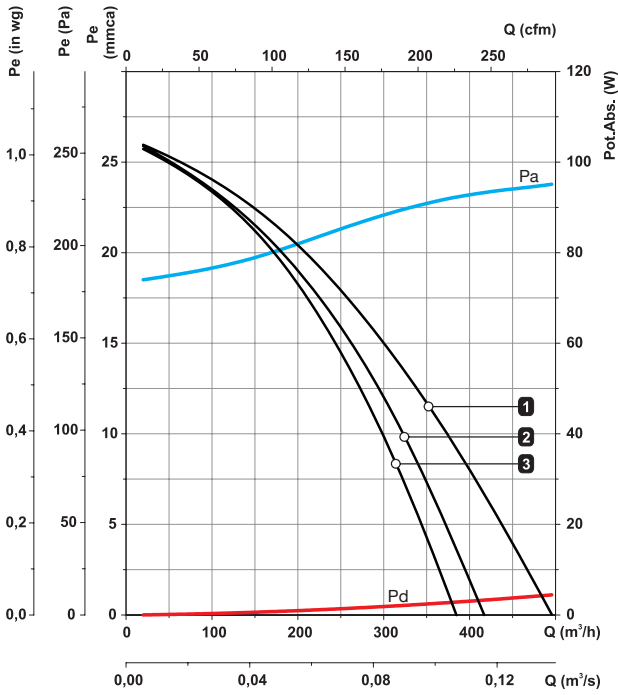

**SV/FILTER 250/H**

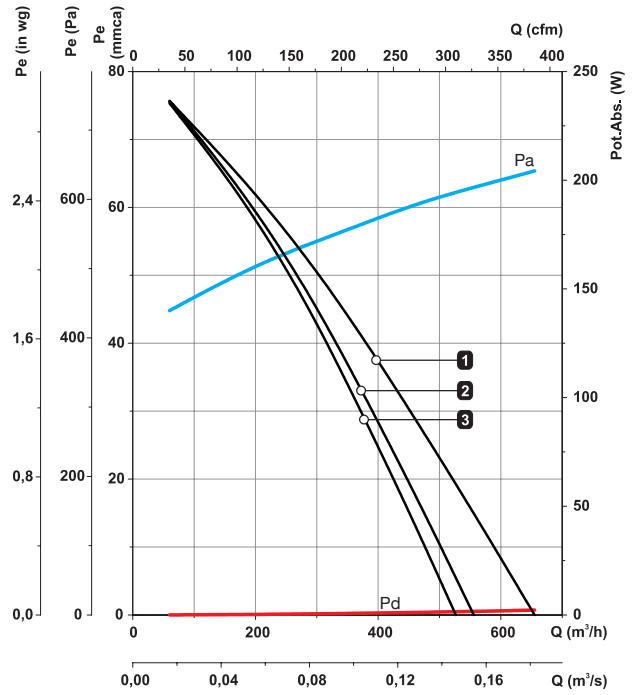

**SV/FILTER 315/H**

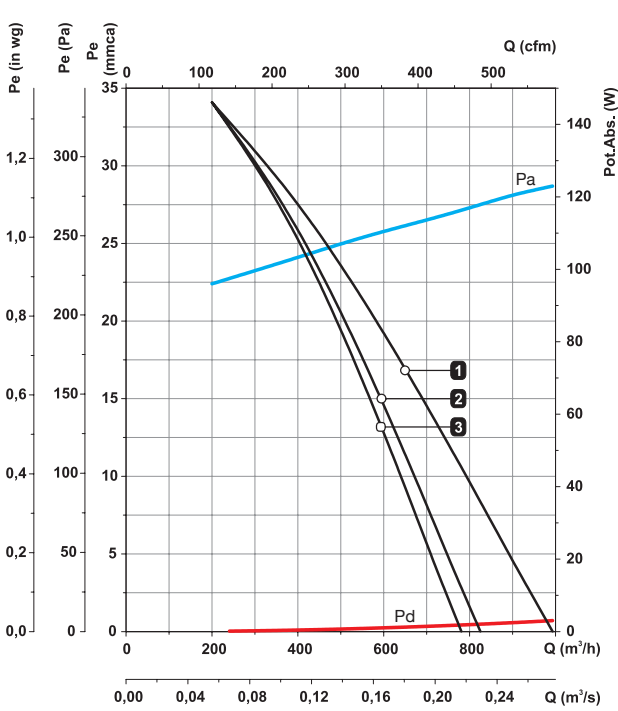

**SV/FILTER 350/H**

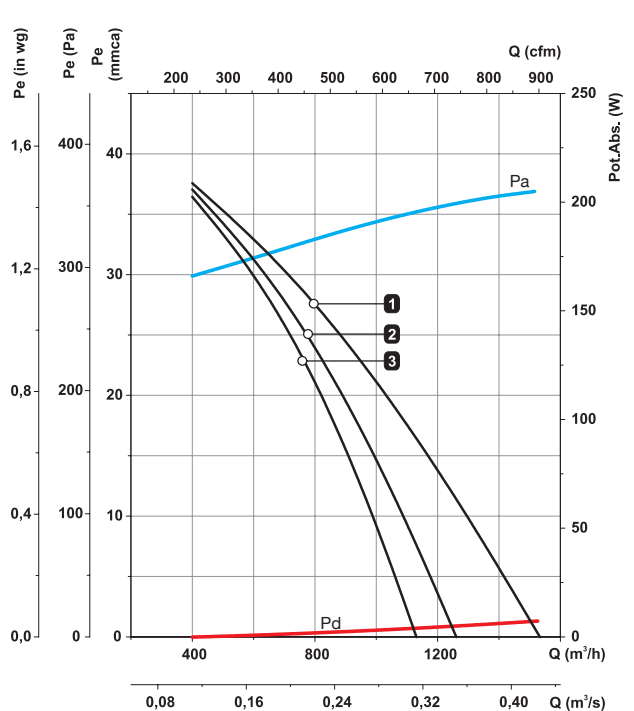

**Characteristic curves**

Equipment curve based on built-in filters **1** G4+F6 **2** F6+F8 **3** F7+F9

Static pressure      Dynamic pressure      Absorbed power

**SV/FILTER 400/H**

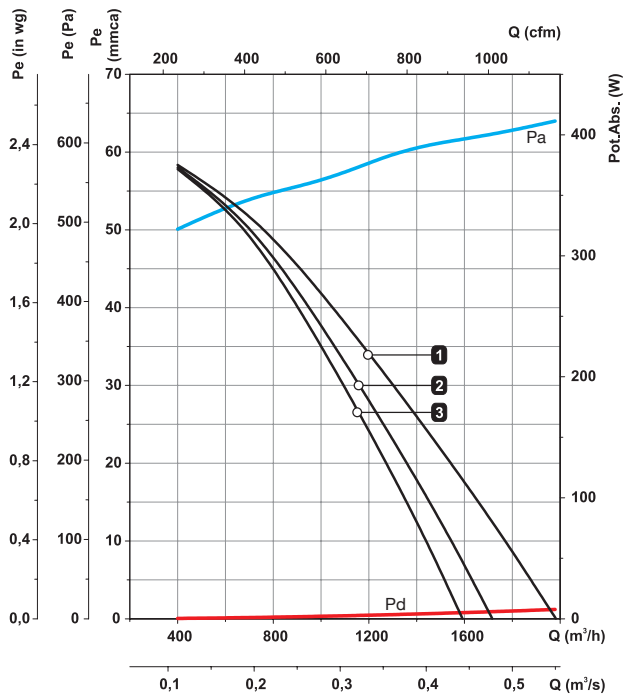

**Accessories**



# UFR

**Filter units with sandwich acoustic insulation, fitted with high performance reaction impeller fans and with different filtering phases, depending on model**



**Characteristics:**

- Acoustically insulated structure.
- Direct actuation.
- Air impulsion configurable on 4 sides.
- F6 + F8, F7 + F9 and G4 + F6 filters, depending on selected model.
- Prefilter option, plus two filtering phases.
- Inspection and cleaning chambers that are easy to access.
- Pressure connections for filter control.
- Pressure sensor for filter control.

**Motor:**

- Class F motors with ball bearings and IP55 protection.
- Multi voltage motor, special design valid for 220/380V 60Hz, 254/440V 60Hz, 265/460V 60Hz, 277/480V 60Hz
- Maximum temperature of air to be carried: -20 °C + 60 °C.

**Finish:**

- Anti-corrosive finished galvanised sheet steel.

**Construction:**

- Galvanised sheet steel structure with acoustic insulation.
- High performance impeller with reaction blades made of sheet steel.
- Built-in general support bench.



**Order code**

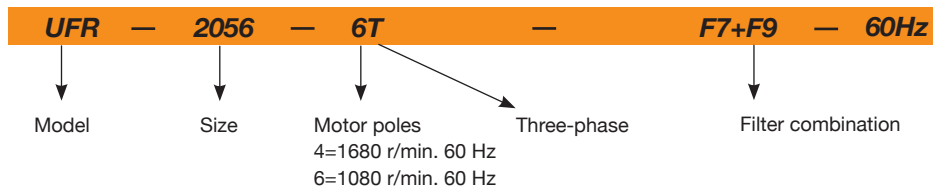

**Technical characteristics**

60Hz

Model	Speed (r/min)	Maximum admissible current (A)		Installed power (kW)	Maximum flow rate (m³/h) Filters (F6+F8)	Maximum flow rate (m³/h) Filters (F7+F9)	Maximum flow rate (m³/h) Filters (G4+F6)	No. of pre-filters		No. of filters		Weight (kg)
		220-277V	380-480V					Full*	Half*	Full*	Half*	
UFR-1240-4T	1716	3.34	1.93	0.75	3.245	3.185	3.005	1	0	1	0	107.5
UFR-1850-4T	1704	5.97	3.45	1.5	4.705	4.620	4.350	1	0	1	0	110
UFR-2056-4T	1716	8.38	4.84	2.2	7.680	7.580	7.235	1	2	1	2	168.5
UFR-2056-6T	1122	3.77	2.18	0.75	5.325	5.250	5.010	1	2	1	2	163
UFR-2263-4T	1752		11.03	5.5	11.995	11.680	11.375	1	2	1	2	221.5
UFR-2263-6T	1140	5.23	3.02	1.1	7.200	7.100	7.000	1	2	1	2	177.5
UFR-2071-4T	1752		20.64	11	15.045	14.535	14.060	1	2	1	2	265
UFR-2071-6T-3	1128	9.28	5.36	2.2	9.175	8.990	8.810	1	2	1	2	195
UFR-2071-6T-5.5	1164	16.35	9.44	4	10.130	9.770	9.440	1	2	1	2	241.5
UFR-2880-6T	1164	16.35	9.44	4	11.500	11.165	10.845	1	2	1	2	242

\*Prefilter dimensions: Full: 585x585x48. Half: 290x585x48  
 \*Filter dimensions: Full: 593x593x292. Half: 288x593x292

Dimensions mm

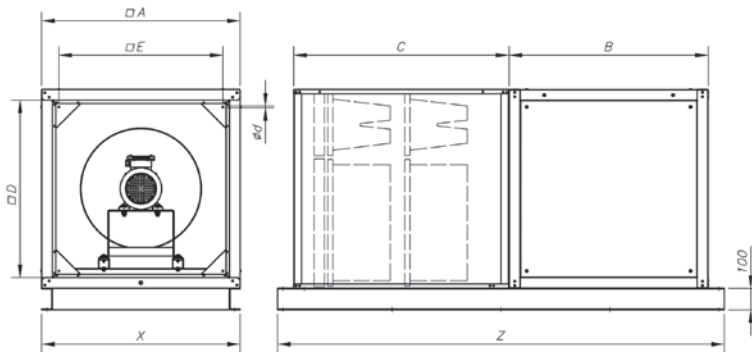

Model	A	B	C	D	E	Ø d	X	Z
UFR-1240-4T	800	800	950	700	640	M6	800	1906
UFR-1850-4T	800	800	950	700	640	M6	800	1906
UFR-2056-4T	925	925	1000	823	763	M6	925	2081
UFR-2056-6T	925	925	1000	823	763	M6	925	2081
UFR-2263-4T	1000	1000	1000	960	838	M6	1000	2156
UFR-2263-6T	925	925	1000	960	763	M6	925	2081
UFR-2071-4T	1060	1060	1000	960	900	M6	1060	2216
UFR-2071-6T	1000	1000	1000	960	838	M6	1000	2156
UFR-2071-6T-5.5	1060	1060	1000	960	900	M6	1060	2216
UFR-2880-6T	1060	1060	1000	960	900	M6	1060	2216

Accessories

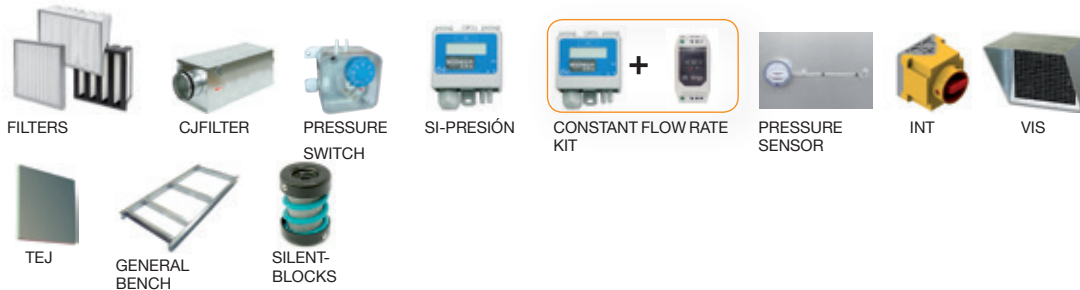

Characteristic curves

Equipment curve based on built-in filters **1** F6+F8 **2** F7+F9 **3** G4+F6  
 Static pressure Dynamic pressure Absorbed power

UFR-1240-4T

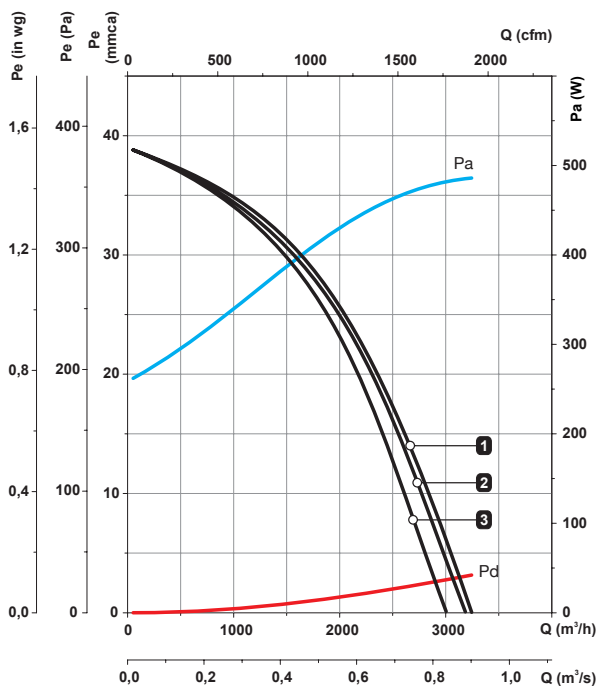

UFR-1850-4T

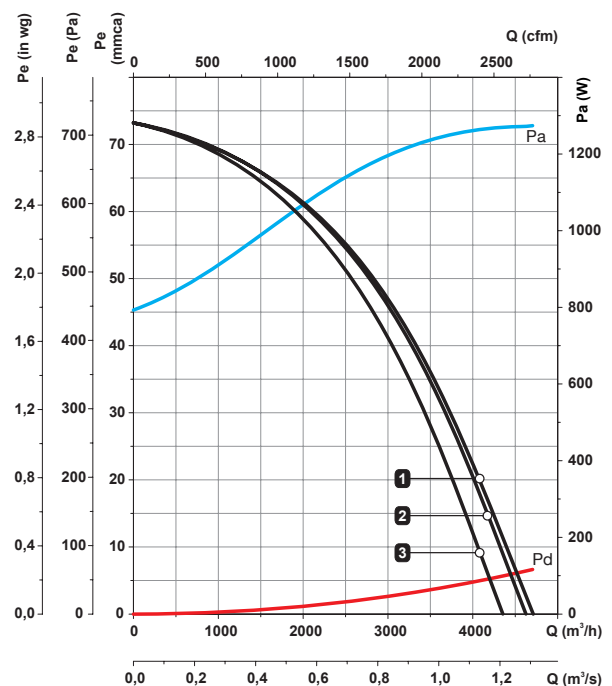

**Characteristic curves**

Equipment curve based on built-in filters **1** F6+F8 **2** F7+F9 **3** G4+F6

Static pressure                           Dynamic pressure                           Absorbed power                     

**UFR-2056-4T**

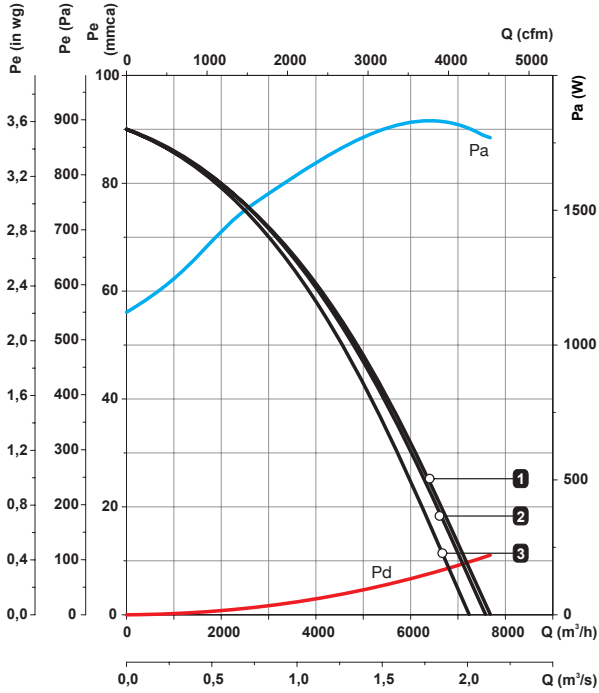

**UFR-2056-6T**

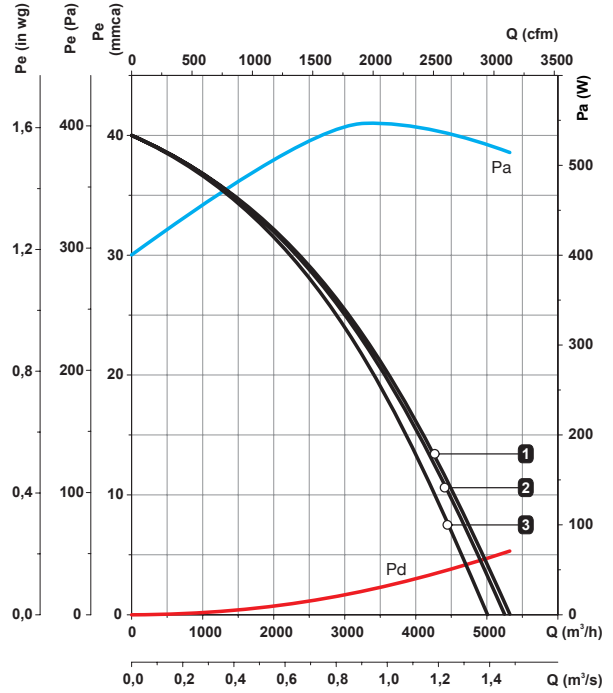

**UFR-2263-4T**

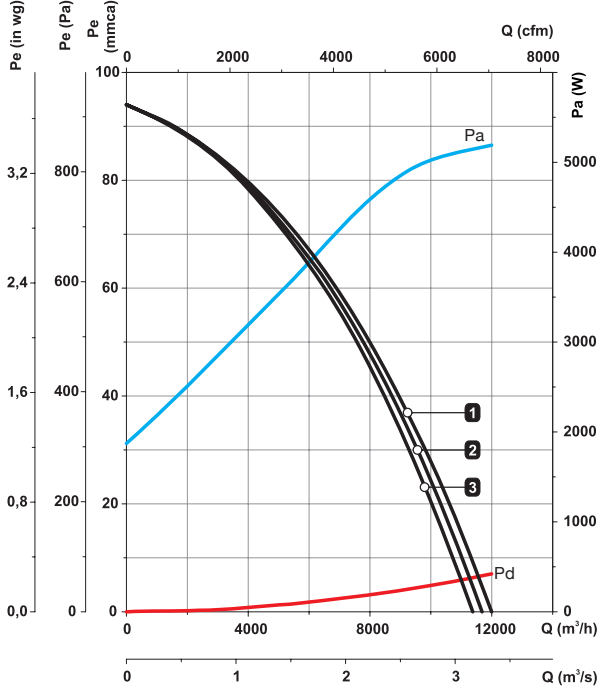

**UFR-2263-6T**

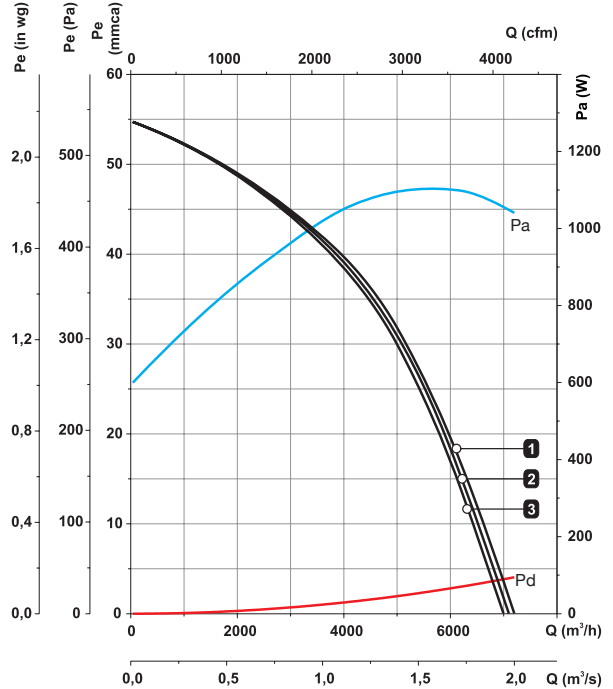

Characteristic curves

Equipment curve based on built-in filters **1** F6+F8 **2** F7+F9 **3** G4+F6

Static pressure                           Dynamic pressure                           Absorbed power                     

UFR-2071-4T

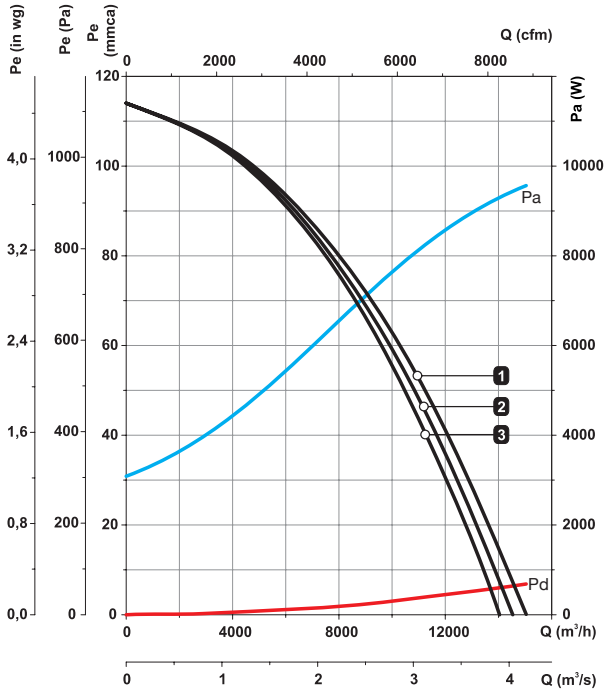

UFR-2071-6T-3

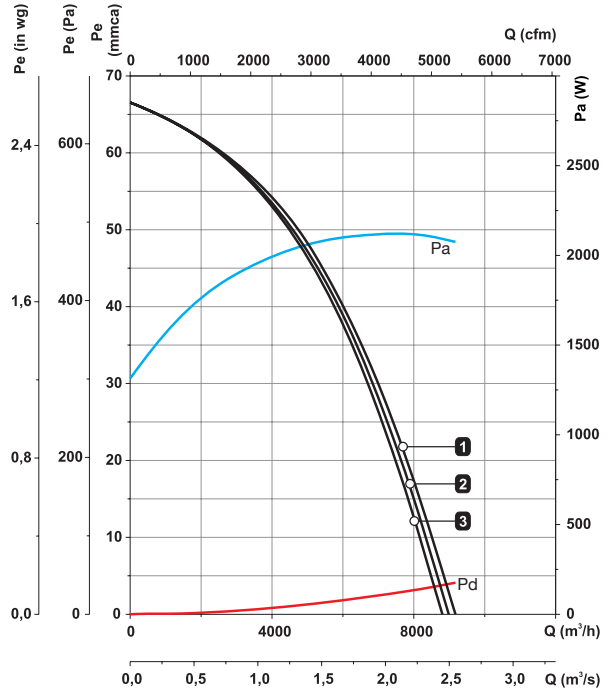

UFR-2071-6T-5.5

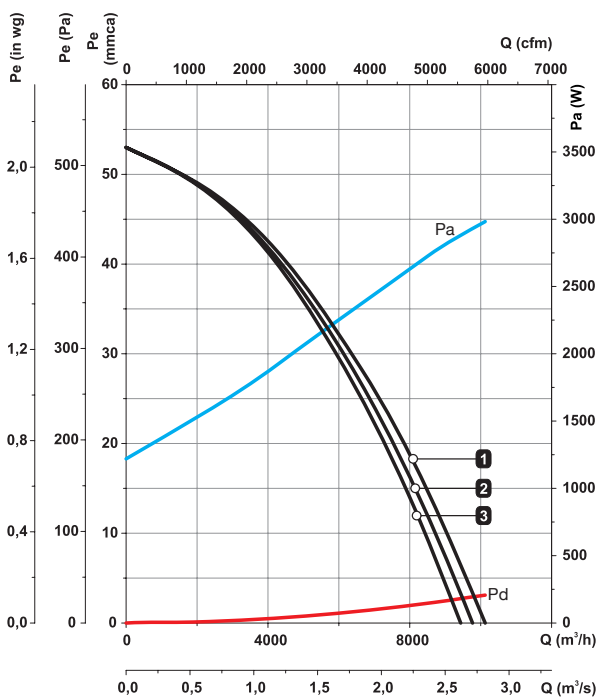

UFR-2880-6T

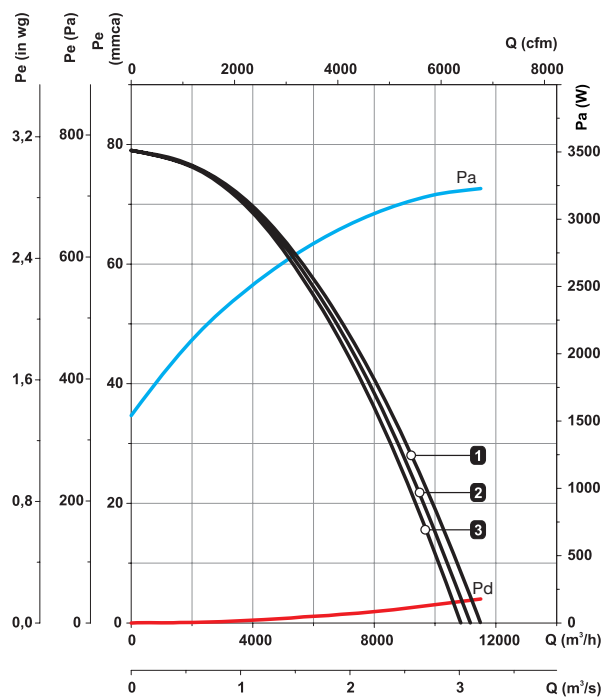

# UDT

**Ventilation units with air treatment system and direct drive motors and acoustic insulation, fitted with double inlet fans and with optional filter, electric or water heating modules**

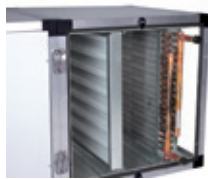

**Box:**

- Aluminium profiles structure with thermal and acoustic insulation.
- Lateral access panel to ensure correct maintenance.
- Modular construction for adding filter or air treatment modules.
- Cable gland for cable entry.

**Fan:**

- Ventilation units fitted with CBD-series fans.
- Impellers with forward-curved blades made of galvanised sheet steel.

**Motor:**

- High efficiency (HE) motors in compliance with ErP 2015.
- Class F motors with ball bearings and IP54 protection.
- Multi voltage motor, special design valid for 220/380V 60Hz, 254/440V 60Hz, 265/460V 60Hz, 277/480V 60Hz
- Maximum temperature of air to be carried: -20 °C + 60 °C.

**Versions:**

- MF: Filtration module. Standard F6+F8 version and optional F7+F9.
- ME: Electric coil module. Standard G4 version and optional with F6+F8 or F7+F9 filters.
- MA: Water coil module. Standard G4 version and optional with F6+F8 or F7+F9 filters.

**On request:**

- Vertical impulsion.
- Impulsion-mounted module.

**Order code**

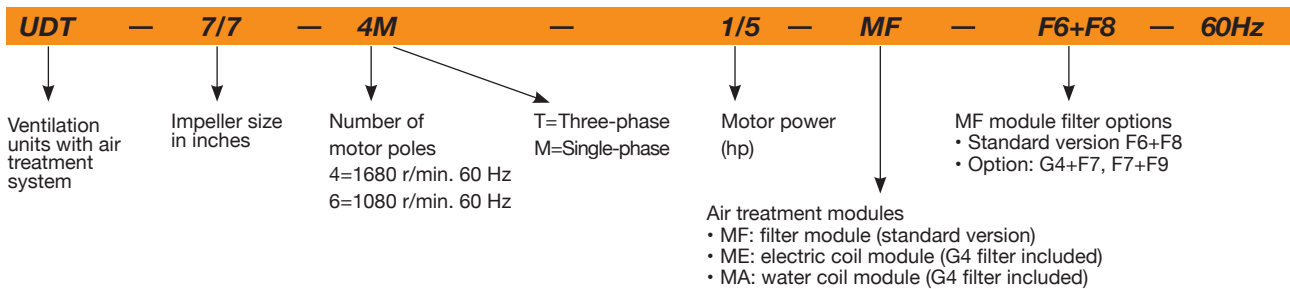

**Technical characteristics**

60Hz

Model	Speed (r/min)	Max. admissible current (A)		Installed power (kW)	Maximum flow rate (m3/h)	Sound level dB(A)	Approx. weight (kg)
		220 V	380 V				
UDT-7/7-4M 1/5	1476	1.4		0.15	1520	60.90	22.5
UDT-9/9-4M 1/2	1584	3.3		0.37	2800	69.30	31.8
UDT-9/9-4M 3/4	1572	4.5		0.55	3600	73.50	32.6
UDT-10/10-4M 1/2	1584	3.3		0.37	2800	68.25	37.3
UDT-10/10-4M 3/4	1572	4.5		0.55	3950	73.50	38.1
UDT-12/12-6T 1 1/2	1080	6.6	3.8	1.1	7800	77.70	53.8
UDT-12/12-6M 3/4	1020	5		0.55	4900	66.15	52.3
UDT-12/12-6M 1	1020	6		0.75	6000	73.50	53.3
UDT-15/15-6T 3	1068	10.9	6.3	2.2	11900	77.70	80

## Dimensions mm

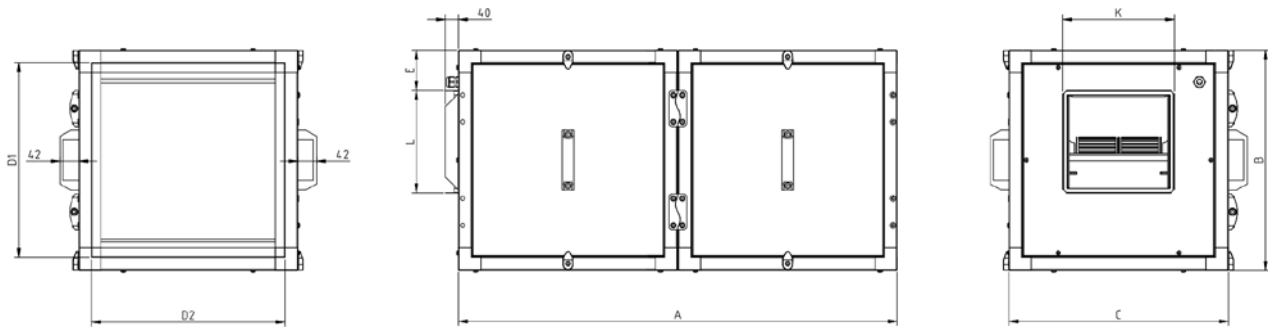

Model	A	B	C	D1	D2	E	L	K
UDT-7/7	981	490	490	428	428	91	226	247
UDT-9/9	1041	550	550	488	488	86	279	317
UDT-10/10	1096	605	605	543	543	88	306	343
UDT-12/12	1171	680	680	618	618	84	360	404
UDT-15/15	1346	855	855	793	793	119	423	490

## Acoustic characteristics

Sound power spectrum Lw(A) in dB(A) per Hz frequency band

Model	63	125	250	500	1000	2000	4000	8000
7/7-4M 1/5	43	54	58	62	64	63	62	53
9/9-4M 1/2	51	62	66	70	72	71	70	61
9/9-4M 3/4	55	66	70	74	76	75	74	65
10/10-4M 1/2	50	61	65	69	71	70	69	60
10/10-4M 3/4	55	66	70	74	76	75	74	65
12/12-6T 1 1/2	59	70	74	78	80	79	78	69
12/12-6M 3/4	48	59	63	67	69	68	67	58
12/12-6M 1	55	66	70	74	76	75	74	65
15/15-6T 3	61	72	77	81	83	81	80	71

## Air treatment module options



F



### MF: Filtration modules

- Aluminium profiles structure with thermal and acoustic insulation.
- Lateral access panel to ensure correct maintenance.
- Modular construction for adding filter or air treatment modules.
- Standard F6+F8 version and optional F7+F9 version module.
- Compatible with the UDT, UDTX, CJBD/ALG, CJBD/ALS, CJBX/ALG and CJBX/ALS series.

### ME: Electric coil modules

- Aluminium profiles structure with thermal and acoustic insulation.
- Lateral access panel to ensure correct maintenance.
- Modular construction for adding filter or air treatment modules.
- Cable gland for cable entry.
- Standard G4 version module and optional with F6+F8 or F7+F9 filters.
- Compatible with the UDT, UDTX, CJBD/ALG, CJBD/ALS, CJBX/ALG and CJBX/ALS series.

### MA: Water coil modules

- Aluminium profiles structure with thermal and acoustic insulation.
- Lateral access panel to ensure correct maintenance.
- Modular construction for adding filter or air treatment modules.
- Standard G4 version module and optional with F6+F8 or F7+F9 filters.
- Compatible with the UDT, UDTX, CJBD/ALG, CJBD/ALS, CJBX/ALG and CJBX/ALS series.



**MF: Filtration module characteristics**

**F Filter load loss**

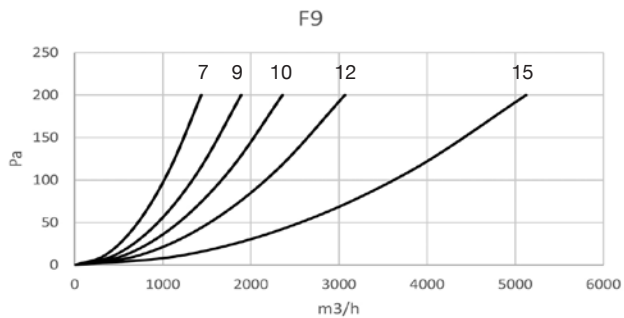
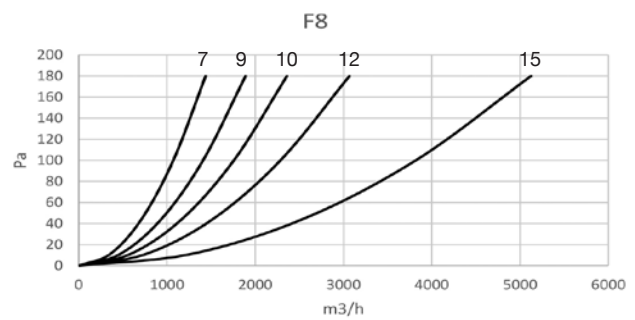
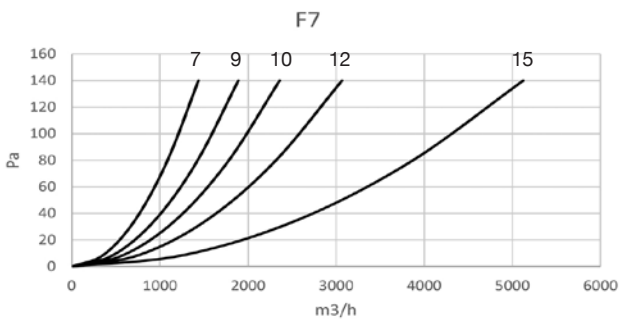
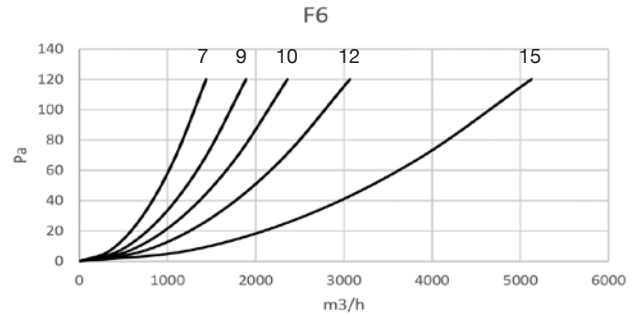
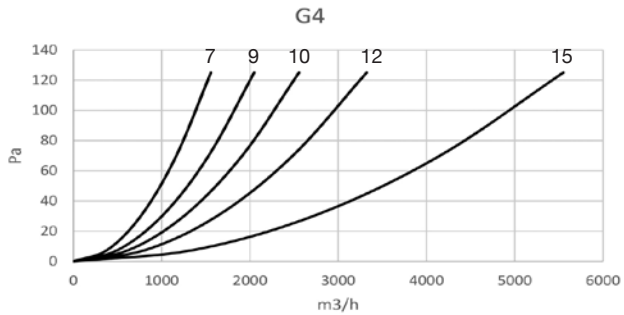

7= MF 7/7  
 9= MF 9/9  
 10= MF 10/10  
 12= MF 12/12  
 15= MF 15/15

**ME: Electric coil module characteristics**



Model	Current (A) 380-480V	Installed power (kW)			Maximum flow rate (m <sup>3</sup> /h)	Approx. weight (kg)
		Phase 1	Phase 2	Phase 3		
ME-7/7	13	3	3	3	1500	23
ME-9/9	23	5.4	5.4	5.4	3300	33
ME-10/10	33	7.7	7.7	7.7	4500	44
ME-12/12	52	12	12	12	6000	61
ME-15/15	81	18.8	18.8	18.8	10000	96

**Electric coil load loss**

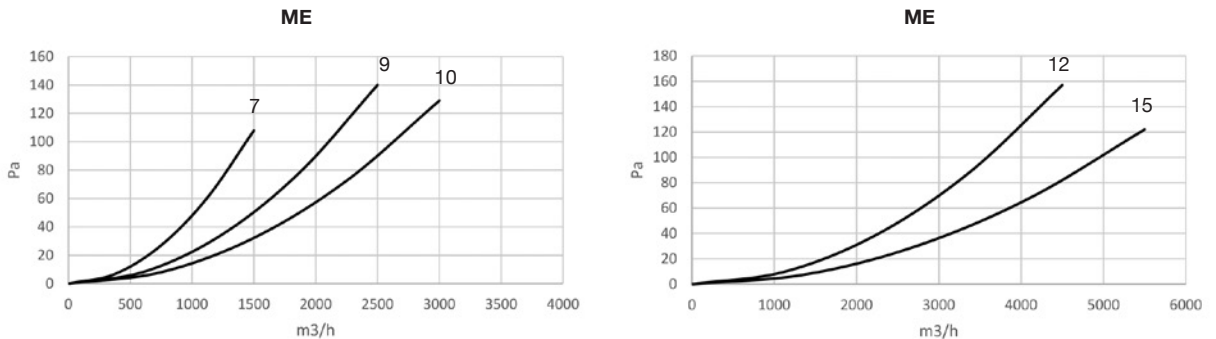

**MA: 90/70 °C water coil module characteristics with air at 0 °C**



Model	Power (kW)	Maximum flow rate (m3/h)	Water flow rate (m3/h)	Water load loss (kPa)	Connection (inch)	Approx. weight (kg)
MA-7/7	23	1500	1.0	16.3	1/2"	18
MA-9/9	37	2500	1.7	26.6	1/2"	25
MA-10/10	46	3000	2.0	17.6	3/4"	31
MA-12/12	66	4500	2.9	29.8	3/4"	39
MA-15/15	108	5500	4.8	21.4	1"	63

**MA: 80/60 °C water coil module characteristics with air at 0 °C**



Model	Power (kW)	Maximum flow rate (m3/h)	Water flow rate (m3/h)	Water load loss (kPa)	Connection (inch)	Approx. weight (kg)
MA-7/7	20	1500	0.9	13.0	1/2"	18
MA-9/9	33	2500	1.4	21.3	1/2"	25
MA-10/10	40	3000	1.7	14.0	3/4"	31
MA-12/12	58	4500	2.5	23.8	3/4"	39
MA-15/15	100	5500	4.2	17.5	1"	63

**Water coil load loss**

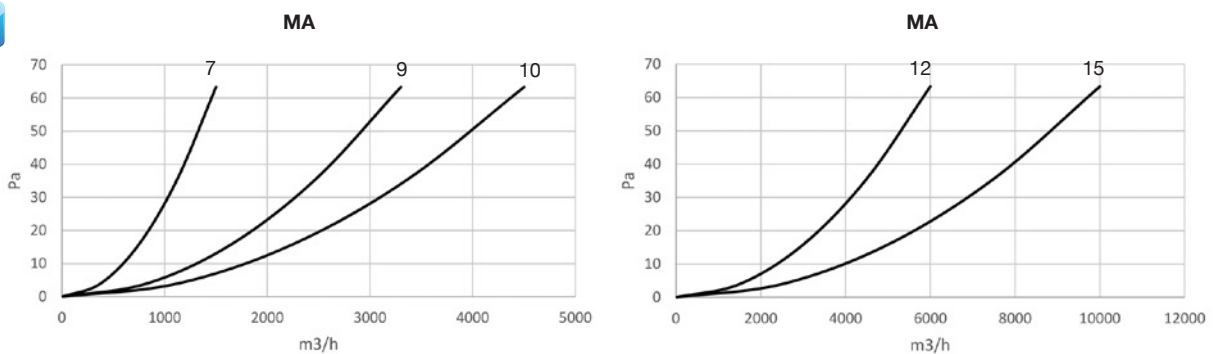

**Installation diagrams and filter position**

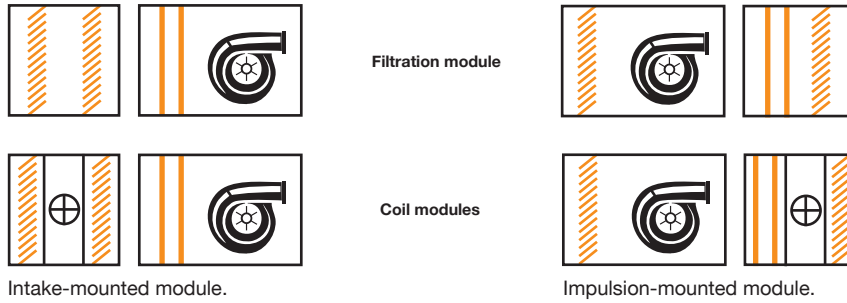

**Module dimensions mm**

Compatible with the UDT, UDTX, CJBD/ALG, CJBD/ALS, CJBX/ALG and CJBX/ALS series.

**F MF MODULES**

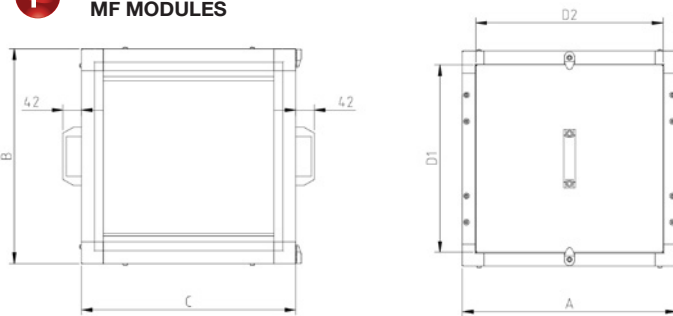

Model	A	B	C	D1	D2
MF-7/7	490	490	490	428	428
MF-9/9	550	550	550	488	488
MF-10/10	605	605	605	543	543
MF-12/12	680	680	680	618	618
MF-15/15	855	855	855	793	793

**ME MODULES**

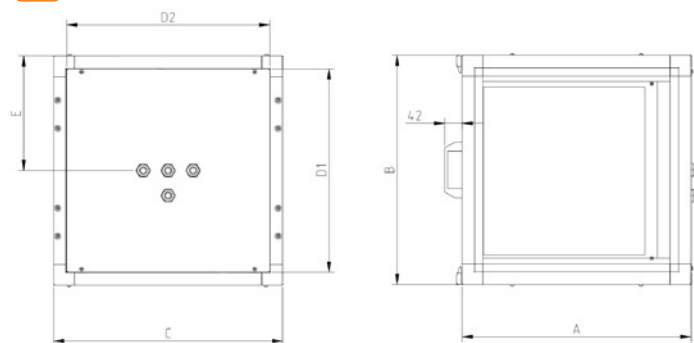

Model	A	B	C	D1	D2	E
ME-7/7	490	490	490	428	428	245
ME-9/9	550	550	550	488	488	275
ME-10/10	605	605	605	543	543	302.5
ME-12/12	680	680	680	618	618	340
ME-15/15	855	855	855	793	793	427.5

**MA MODULES**

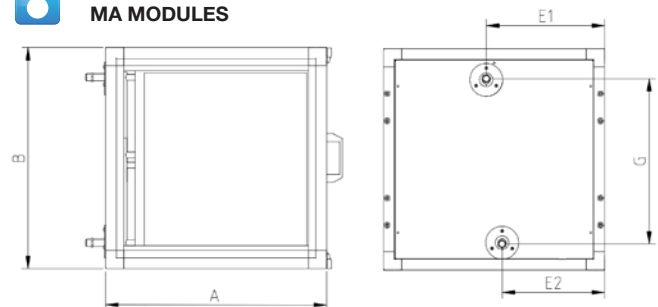

Model	A	B	C	D1	D2	E1	E2	G	H
MA-7/7	490	490	490	428	428	267	224	334	60
MA-9/9	550	550	550	488	488	297	254	410	57
MA-10/10	605	605	605	543	543	324	281	452	54
MA-12/12	680	680	680	618	618	362	319	527	79
MA-15/15	855	855	855	793	793	460	395	671	42

Fan characteristic curves

7/7

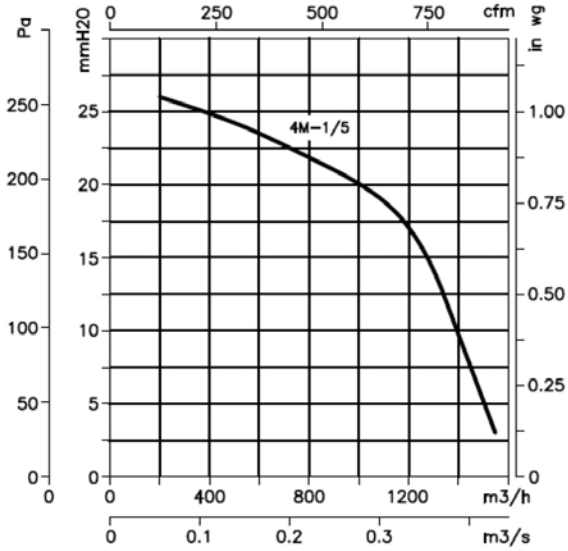

9/9

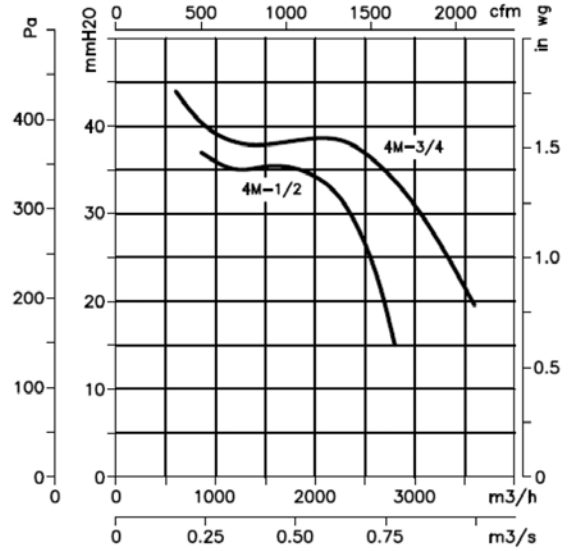

10/10

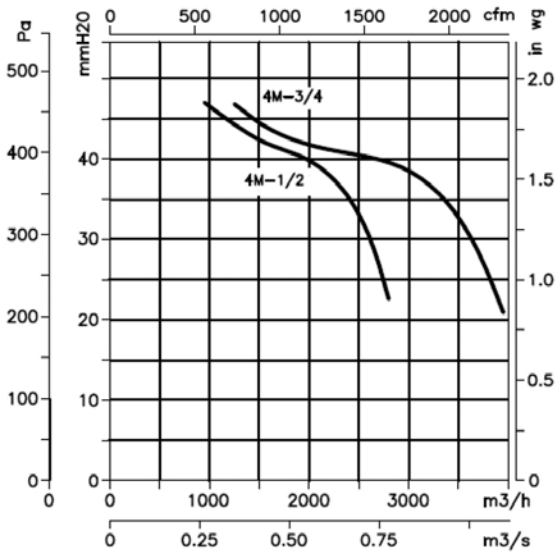

12/12 15/15

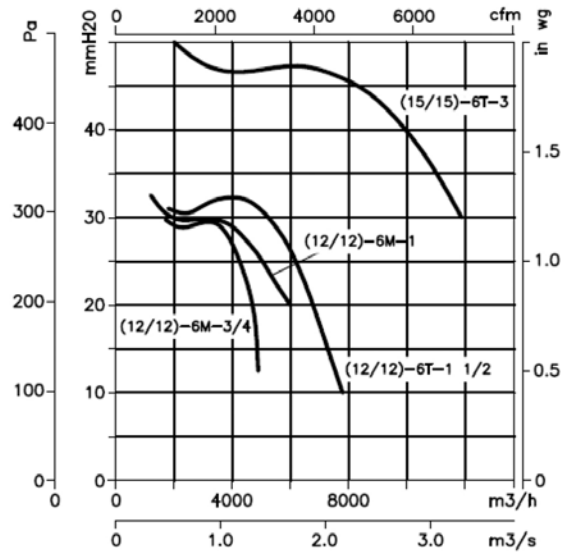

# UDTX

**Ventilation units with belt-driven air treatment systems and acoustic insulation, fitted with double inlet fans and with optional filter, electric or water heating modules**

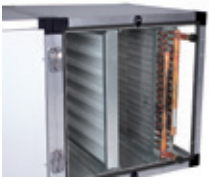

**Box:**

- Aluminium profiles structure with thermal and acoustic insulation.
- Lateral access panel to ensure correct maintenance.
- Modular construction for adding filter or air treatment modules.
- Cable gland for cable entry.

**Fan:**

- Ventilation units fitted with fans from the CBX, CBXC and CBXR series.
- Impellers with forward-curved blades made of galvanised sheet steel.

**Motor:**

- IE3 efficiency motors for powers equal to or greater than 0.75kW except single-phase, 2-speed and 8-pole.
- Class F motors with ball bearings and IP54 protection.

- Multi voltage motor, special design valid for 220/380V 60Hz, 254/440V 60Hz, 265/460V 60Hz, 277/480V 60Hz
- Maximum temperature of air to be carried: -20 °C + 60 °C.

**Versions:**

- MF: Filtration module. Standard F6+F8 version and optional F7+F9.
- ME: Electric coil module. Standard G4 version and optional with F6+F8 or F7+F9 filters.
- MA: Water coil module. Standard G4 version and optional with F6+F8 or F7+F9 filters.

**On request:**

- Vertical impulsion.
- Left side transmission.
- Impulsion-mounted module.

**Order code**

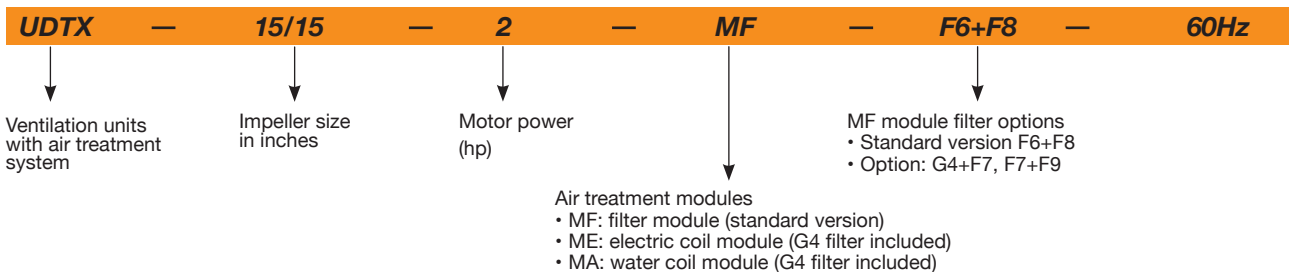

**Technical characteristics**



Model	Speed (r/min)	Max. admissible current (A)		Installed power (kW)	Maximum flow rate (m3/h)	Sound level dB(A)	Approx. weight (kg)	Mounting version
		220-277V	380-480V					
UDTX-7/7-0.25	1090	1.23	0.71	0.18	1050	48	37	A
UDTX-7/7-0.33	1220	1.66	0.96	0.25	1100	50	37.8	A
UDTX-7/7-0.5	1420	2.02	1.17	0.37	1250	53	39	A
UDTX-7/7-0.75	1600	2.92	1.69	0.55	1450	56	41	A
UDTX-7/7-1	1790	3.1	1.79	0.75	1500	58	42.5	A
UDTX-9/9-0.25	825	1.23	0.71	0.18	1700	45	48	A
UDTX-9/9-0.33	920	1.66	0.96	0.25	1800	48	50	A
UDTX-9/9-0.5	1020	2.02	1.17	0.37	2200	51	51.5	A
UDTX-9/9-0.75	1050	2.92	1.69	0.55	2900	55	54.5	A
UDTX-9/9-1	1070	3.1	1.79	0.75	3200	56	56	A
UDTX-9/9-1.5	1260	4.03	2.32	1.1	3750	60	59	A
UDTX-10/10-0.5	845	2.02	1.17	0.37	2950	52	55	A

### Technical characteristics

Model	Speed (r/min)	Max. admissible current (A)		Installed power (kW)	Maximum flow rate (m <sup>3</sup> /h)	Sound level dB(A)	Approx. weight (kg)	Mounting version
		220-277V	380-480V					
UDTX-10/10-0,75	845	2.92	1.69	0.55	3800	56	57	A
UDTX-10/10-1	960	3.1	1.79	0.75	4175	58	58.5	A
UDTX-10/10-1,5	1070	4.03	2.32	1.1	4800	61	61.3	A
UDTX-10/10-2	1140	5.96	3.44	1.5	5400	63	64.6	A
UDTX-12/12-0,5	595	2.02	1.17	0.37	4200	52	69	A
UDTX-12/12-0,75	675	2.92	1.69	0.55	4800	54	71	A
UDTX-12/12-1	765	3.1	1.79	0.75	5400	57	72.4	A
UDTX-12/12-1,5	855	4.03	2.32	1.1	5800	59	75.3	A
UDTX-12/12-2	965	5.96	3.44	1.5	6500	62	78.6	A
UDTX-12/12-3	1180	8.36	4.83	2.2	7400	65	87	A
UDTX-15/15-0,75	525	2.92	1.69	0.55	5900	49	85	B
UDTX-15/15-1	595	3.1	1.79	0.75	6500	52	86.4	B
UDTX-15/15-1,5	635	4.03	2.32	1.1	7500	54	89.3	B
UDTX-15/15-2	670	5.96	3.44	1.5	8200	56	92.6	B
UDTX-15/15-3	740	8.36	4.83	2.2	9500	59	101	B
UDTX-15/15-4	805	10.96	6.33	3	10600	61	103	B
UDTX-15/15-5,5	965	14.1	8.12	4	12000	63	108	B
UDTX-18/18-1,5	480	4.03	2.32	1.1	9000	48	122	B
UDTX-18/18-2	605	5.96	3.44	1.5	9250	51	125.3	B
UDTX-18/18-3	590	8.36	4.83	2.2	11500	54	133.7	B
UDTX-18/18-4	640	10.96	6.33	3	13200	56	135.7	B
UDTX-18/18-5,5	675	14.1	8.12	4	15000	58	141	B
UDTX-18/18-7,5	760		11.6	5.5	17000	60	154.5	B

### Dimensions mm

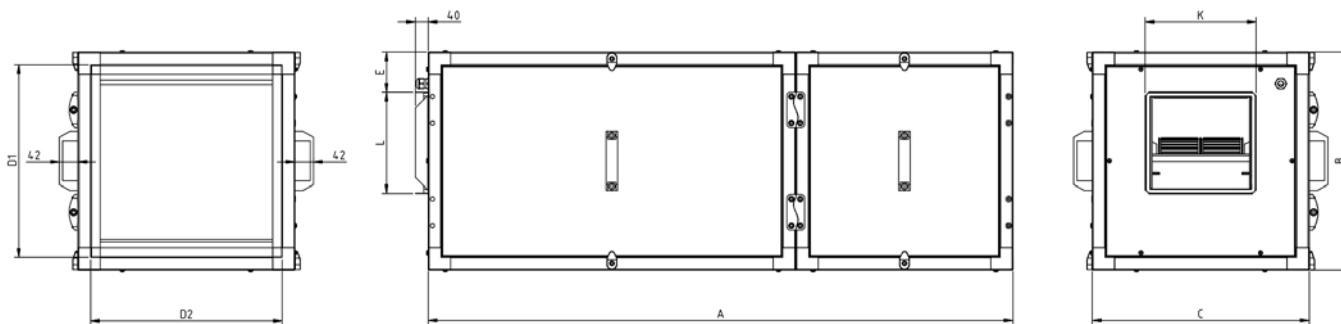

Model	A	B	C	D1	D2	E	L	K
UDTX-7/7	1321	490	490	428	428	91	226	247
UDTX-9/9	1411	550	550	488	488	86	279	317
UDTX-10/10	1461	605	605	543	543	88	306	343
UDTX-12/12	1541	680	680	618	618	84	360	404
UDTX-15/15	1711	855	855	793	793	119	423	490
UDTX-18/18	1847	1000	1000	938	938	137	498	554

**Air treatment module options**



**MF: Filtration modules**

- Aluminium profiles structure with thermal and acoustic insulation.
- Lateral access panel to ensure correct maintenance.
- Modular construction for adding filter or air treatment modules.
- Standard F6+F8 version and optional F7+F9 version module.
- Compatible with the UDT, UDTX, CJBD/ALG, CJBD/ALS, CJBX/ALG and CJBX/ALS series.

**ME: Electric coil modules**

- Aluminium profiles structure with thermal and acoustic insulation.
- Lateral access panel to ensure correct maintenance.
- Modular construction for adding filter or air treatment modules.
- Cable gland for cable entry.
- Standard G4 version module and optional with F6+F8 or F7+F9 filters.
- Compatible with the UDT, UDTX, CJBD/ALG, CJBD/ALS, CJBX/ALG and CJBX/ALS series.

**MA: Water coil modules**

- Aluminium profiles structure with thermal and acoustic insulation.
- Lateral access panel to ensure correct maintenance.
- Modular construction for adding filter or air treatment modules.
- Standard G4 version module and optional with F6+F8 or F7+F9 filters.
- Compatible with the UDT, UDTX, CJBD/ALG, CJBD/ALS, CJBX/ALG and CJBX/ALS series.

**MF: Filtration module characteristics**

**F Filter load loss**

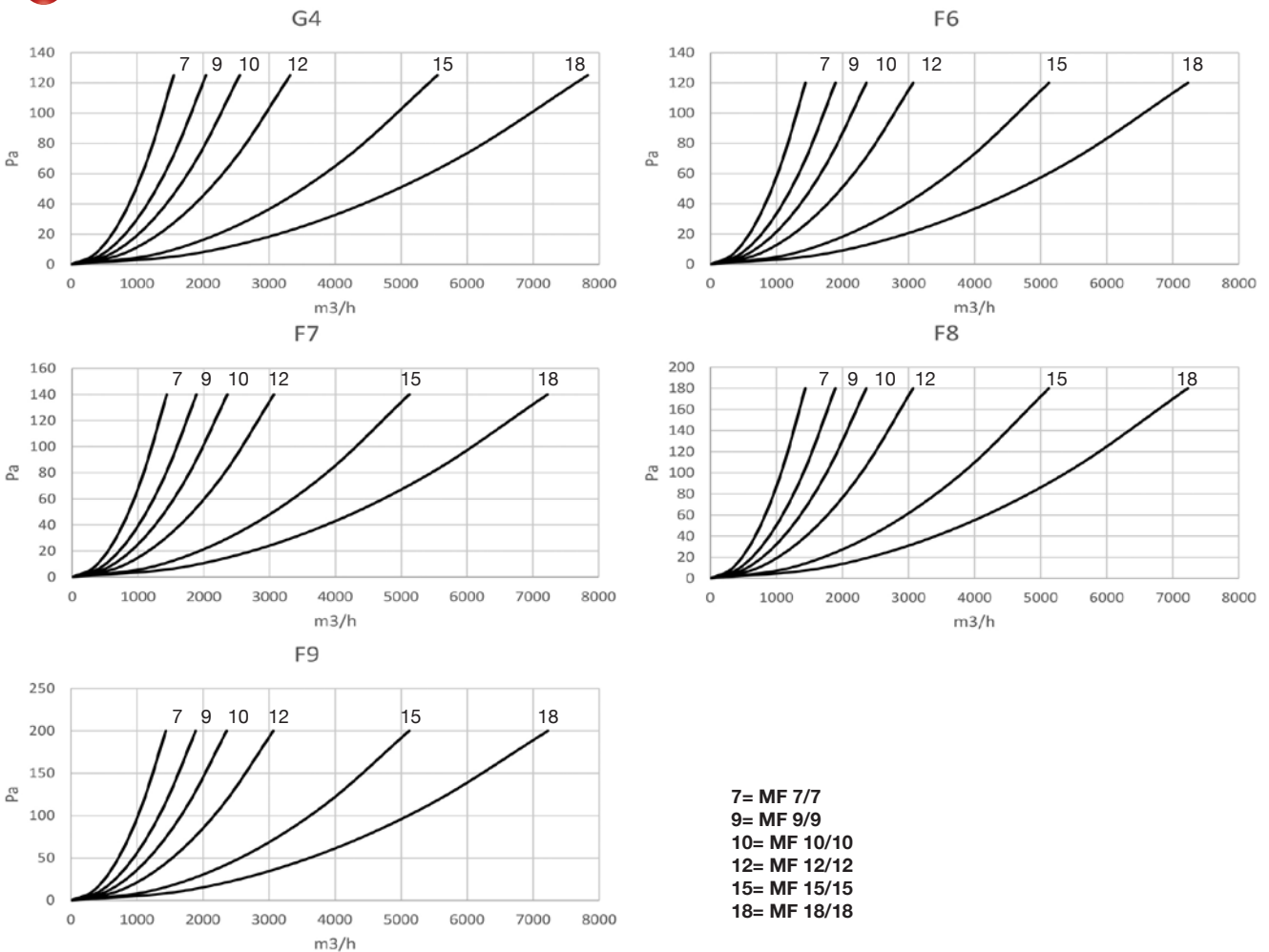

### ME: Electric coil module characteristics



Model	Current (A)	Installed power (kW)			Maximum flow rate (m <sup>3</sup> /h)	Approx. weight (kg)
	400V	Phase 1	Phase 2	Phase 3		
ME-7/7	13	3	3	3	1500	23
ME-9/9	23	5.4	5.4	5.4	3300	33
ME-10/10	33	7.7	7.7	7.7	4500	44
ME-12/12	52	12	12	12	6000	61
ME-15/15	81	18.8	18.8	18.8	10000	96
ME-18/18	97	22.5	22.5	22.5	13000	123

### Electric coil load loss

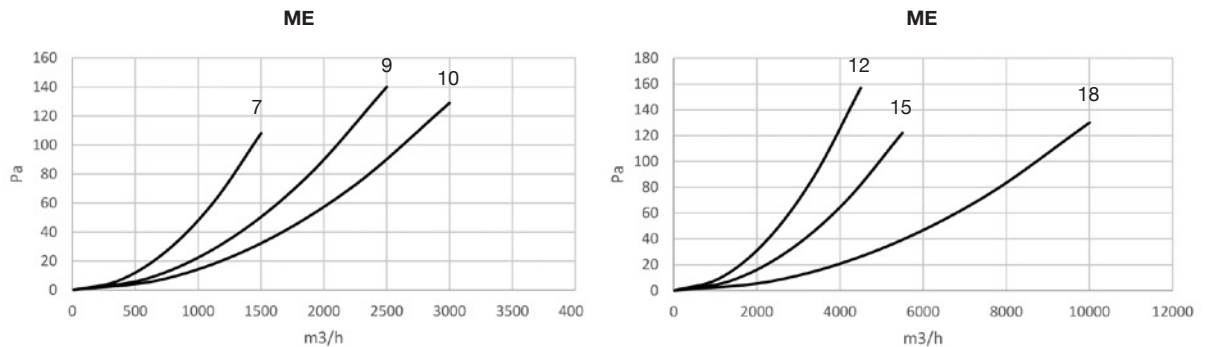

### MA: 90/70 °C water coil module characteristics with air at 0 °C



Model	Power (kW)	Maximum flow rate (m <sup>3</sup> /h)	Water flow rate (m <sup>3</sup> /h)	Water load loss (kPa)	Connection (inch)	Approx. weight (kg)
	MA-7/7	23	1500	1.0	16.3	
MA-9/9	37	2500	1.7	26.6	1/2"	25
MA-10/10	46	3000	2.0	17.6	3/4"	31
MA-12/12	66	4500	2.9	29.8	3/4"	39
MA-15/15	108	5500	4.8	21.4	1"	63
MA-18/18	153	10000	6.8	21.9	1 1/4"	87

### MA: 80/60 °C water coil module characteristics with air at 0 °C



Model	Power (kW)	Maximum flow rate (m <sup>3</sup> /h)	Water flow rate (m <sup>3</sup> /h)	Water load loss (kPa)	Connection (inch)	Approx. weight (kg)
	MA-7/7	20	1500	0.9	13.0	
MA-9/9	33	2500	1.4	21.3	1/2"	25
MA-10/10	40	3000	1.7	14.0	3/4"	31
MA-12/12	58	4500	2.5	23.8	3/4"	39
MA-15/15	100	5500	4.2	17.5	1"	63
MA-18/18	133	10000	5.8	17.5	1 1/4"	87

### Water coil load loss

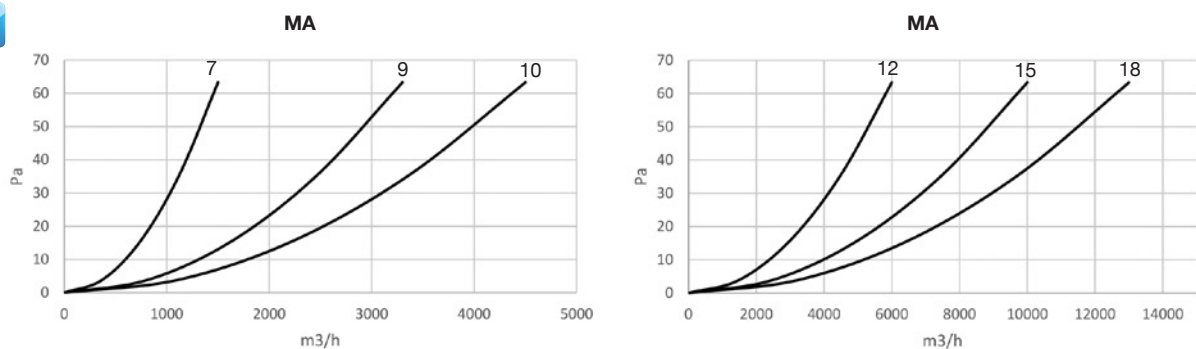



**Installation diagrams and filter position**

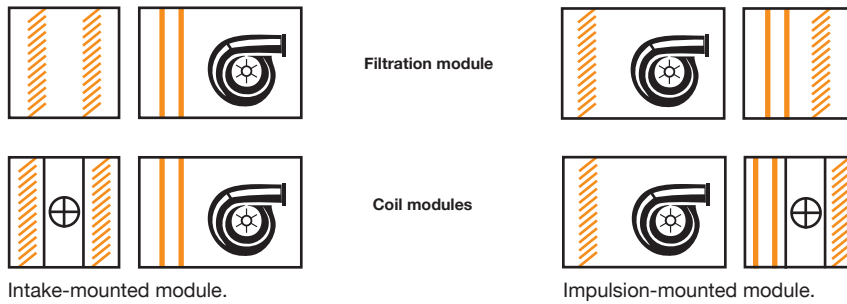

**Module dimensions mm**

Compatible with the UDT, UDTX, CJBD/ALG, CJBD/ALS, CJBX/ALG and CJBX/ALS series.

**F MF MODULES**

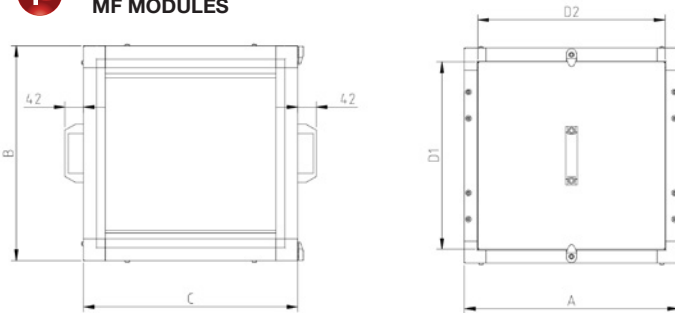

Model	A	B	C	D1	D2
MF-7/7	490	490	490	428	428
MF-9/9	550	550	550	488	488
MF-10/10	605	605	605	543	543
MF-12/12	680	680	680	618	618
MF-15/15	855	855	855	793	793
MF-18/18	1000	1000	1000	938	938

**ME MODULES**

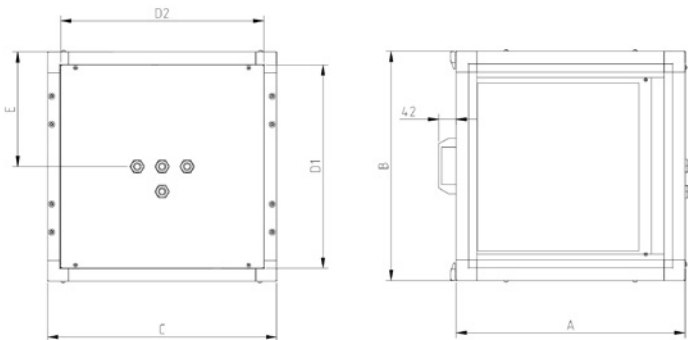

Model	A	B	C	D1	D2	E
ME-7/7	490	490	490	428	428	245
ME-9/9	550	550	550	488	488	275
ME-10/10	605	605	605	543	543	302.5
ME-12/12	680	680	680	618	618	340
ME-15/15	855	855	855	793	793	427.5
ME-18/18	1000	1000	1000	938	938	500

**MA MODULES**

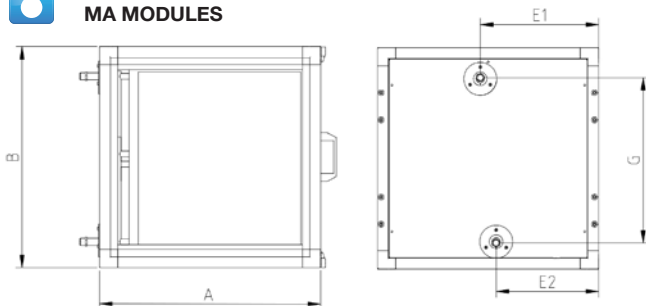

Model	A	B	C	D1	D2	E1	E2	G	H
MA-7/7	490	490	490	428	428	267	224	334	60
MA-9/9	550	550	550	488	488	297	254	410	57
MA-10/10	605	605	605	543	543	324	281	452	54
MA-12/12	680	680	680	618	618	362	319	527	79
MA-15/15	855	855	855	793	793	460	395	671	42
MA-18/18	1000	1000	1000	938	938	522	479	814	47

Fan characteristic curves

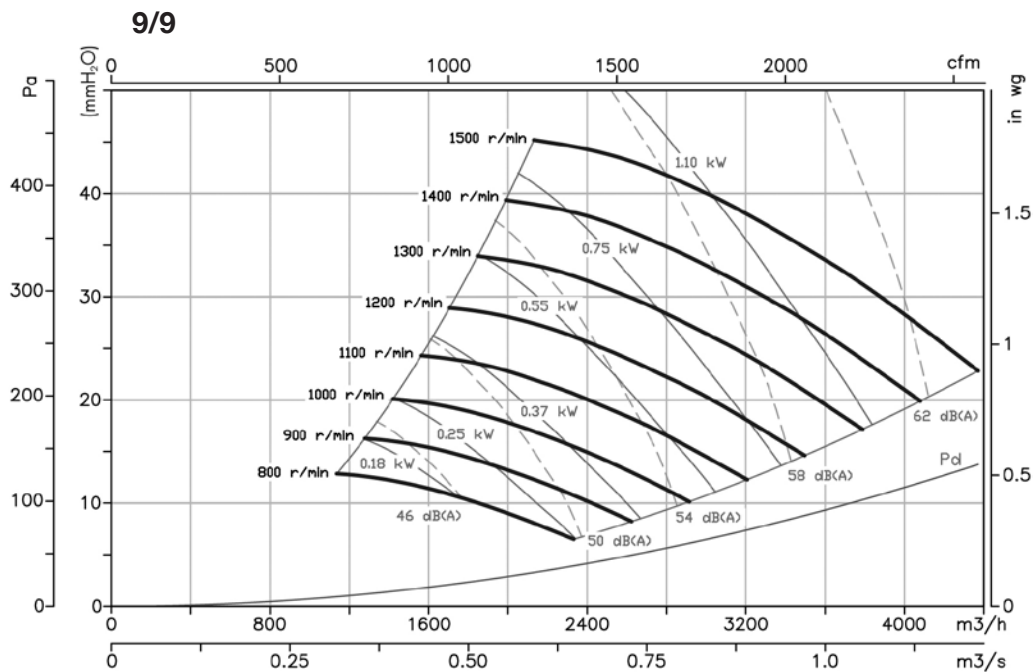
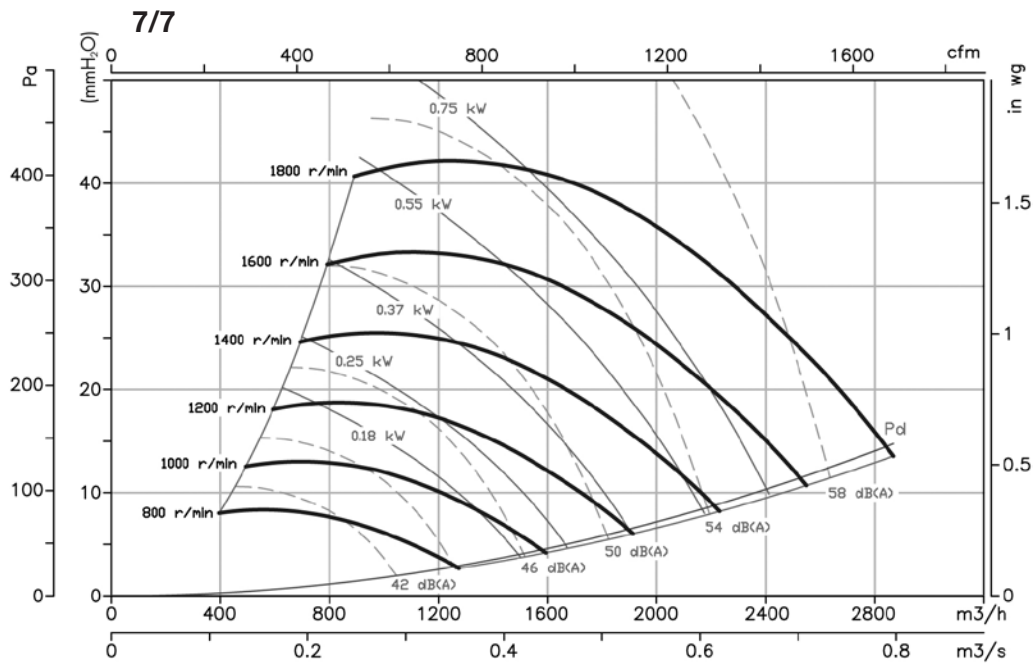

Fan characteristic curves

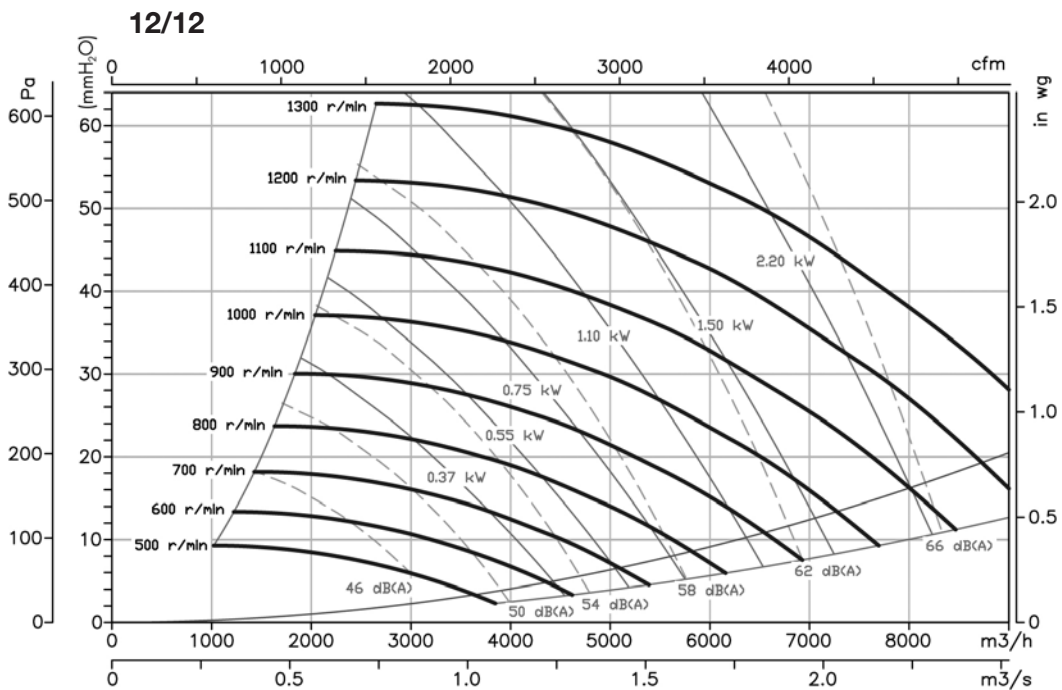
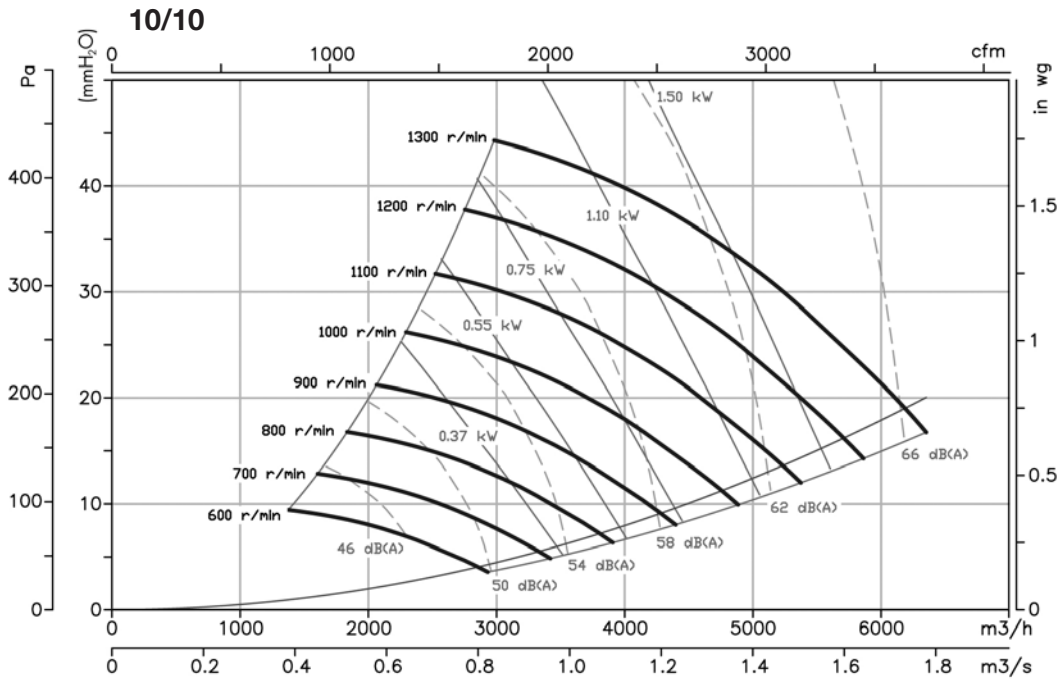

Fan characteristic curves

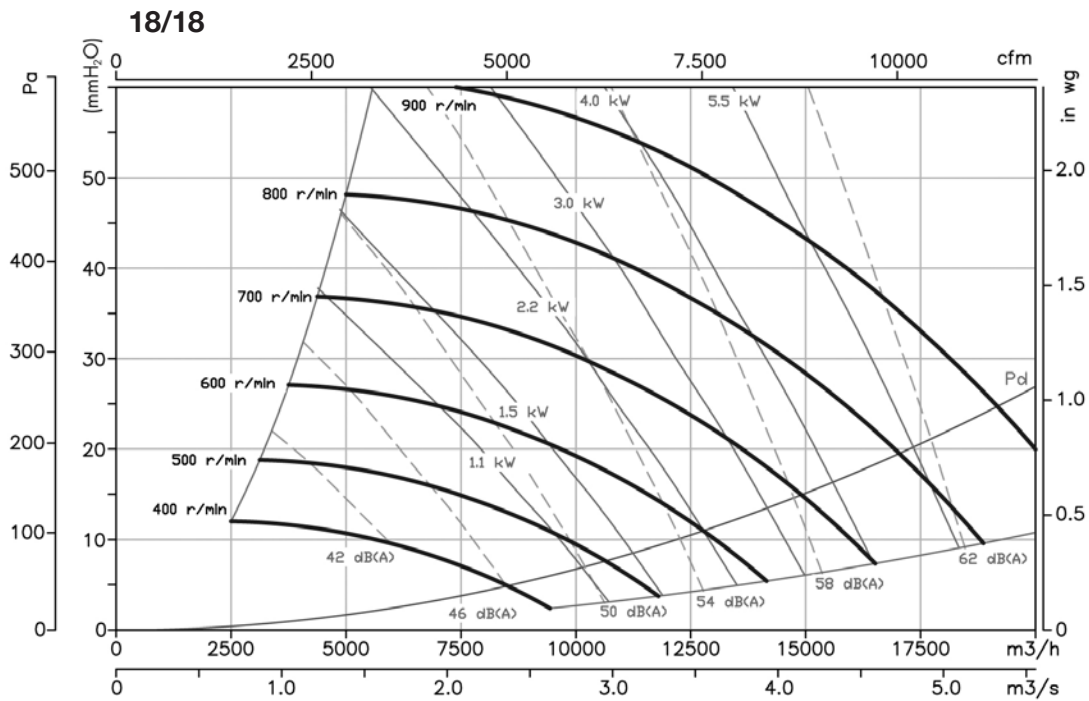
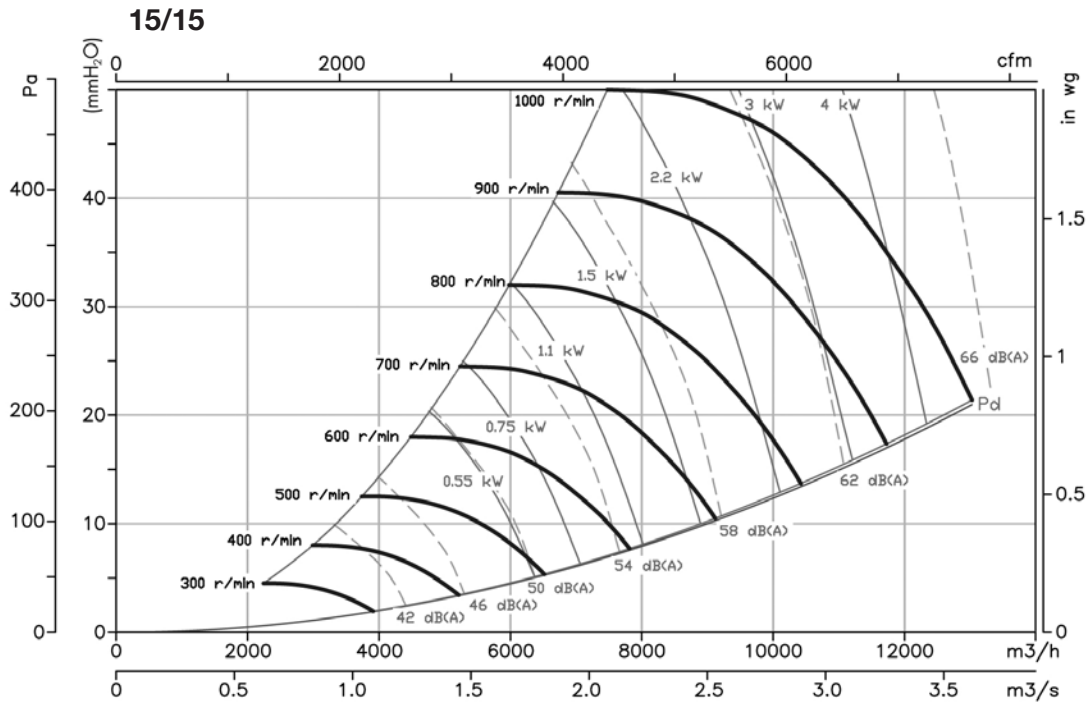

# INDUSTRIAL AND COMMERCIAL AIR CURTAINS



## EFFICIENCY WITHOUT RESERVATIONS

Air curtains achieve savings in consumption of up to 30% in indoor air conditioning systems, preventing draughts and temperature gradients that also affect comfort and well-being.

## NEW DESIGN

Curtains with a perfect blend of innovation and design.



## MULTIPLE APPLICATIONS

Large range of curtains appropriate for multiple applications, door dimensions and mounting options.



## VARIED CONTROL OPTIONS

Most air curtains have different control options, to respond to different needs.



## EFFICIENT DESIGNS

Efficient designs that achieve adjustable laminar flows with a large range and efficiency and minimal power consumptions.

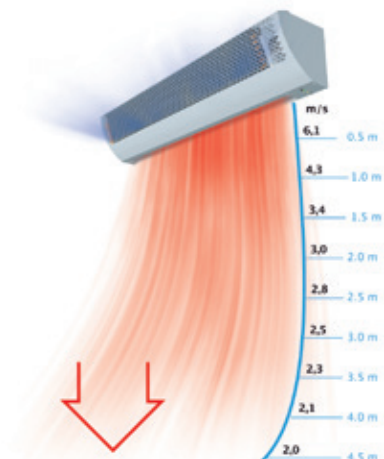

## AIR CURTAIN TYPES

---

The air curtains may be used for simply recirculating the interior air or they can be used for heating buildings:



### ENVIRONMENTAL

Recirculation of ambient air with fans, without supplying heat.



### ELECTRIC

Recirculation of ambient air and when necessary, heating the air with electric elements during the winter.



### HOT WATER

Recirculation of ambient air and when necessary, heating the air with hot water coils during the winter.

Curtains with electric or water coil heating can be used as heating elements, as their performance and hot air volumes are able to heat up a surface area of 500 to 750 m<sup>2</sup>, depending on the model, in the door area.

## SELECTION AND INSTALLATION OF AIR CURTAINS

---

- 1 Define the air curtain series you are interested in, the door height and the preferred design.
- 2 Select the most appropriate model, depending on the door length. The curtain must cover the door opening and an extra 100mm on each side.
- 3 Select the type of curtain you want: environmental, electric or hot water type.
- 4 Select the air curtain that best suits your needs to obtain the adequate noise level.
- 5 Install the curtain as close as possible to the entrance, on the inside wall of the premises.
- 6 In the case of separated premises that are very cool, install the air curtain on the wall with the most heat.

For optimal operation, it is advisable to install and control the air curtain using controllers specifically designed for this application.

# ECONOMIC

## Economical air curtains for small commercial establishments

Economical air curtains for heights of up to 3m. for horizontal installation, specially designed for small commercial establishments.



Control

**Construction:**

- Painted metal structure
- Designed for horizontal mounting
- Version S: Two-speed fan operation
- Operation led indicator lamp
- Supports for attachment to wall
- Version E: Electric coil control with safety elements. Delayed fan stop to evacuate residual heat



**Version:**

- Environmental: Recirculation of air
- Electric: Built-in electric elements



**External control**

- Version E: Remote control operation

<b>Applications:</b>	Small commercial premises Stores	Bars Offices
----------------------	-------------------------------------	-----------------

Control:		
Operation	manual	manual
Speeds	2 speeds	1 speed
Electric coil control	no	1 power level
Door contact	no	no
Operation indicator lamp	yes	yes

**Order code**

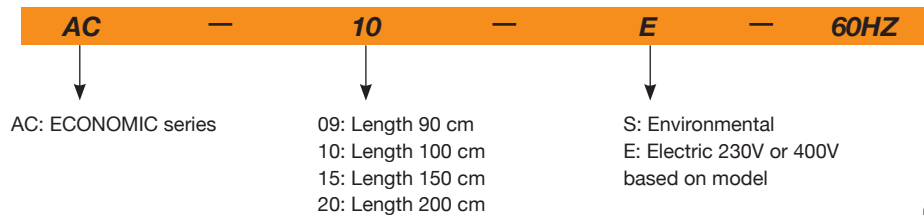

**Technical characteristics**



Model	Door height (m)	Max. flow rate (m³/h)	Irradiated SPL dB(A)	Heating power (kW)	Coil voltage (V)	Coil current (A)	Fan voltage (V)	Fan current (A)	Weight (kg)
AC-09-S	3	1440	45.15				1x220	0.65	14.5
AC-10-S	3	1620	46.20				1x220	0.72	16
AC-15-S	3	2520	48.30				1x220	0.95	23.5
AC-09-E	3	1200	47.25	3.5	1x230	15	1x220	0.65	18
AC-10-E	3	1380	48.30	4.0	1x230	19	1x220	0.72	20
AC-15-E	3	2160	49.35	5.5	3X400	9	1x220	0.95	31
AC-20-E	3	2880	53.55	10	3X400	16	1x220	1.38	39

**Dimensions mm**

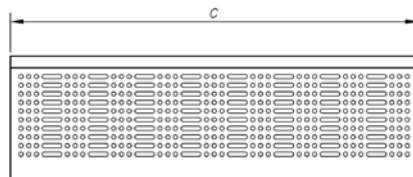
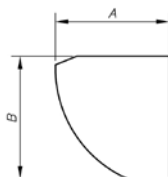

Model	A	B	C
AC-09-S	200	215	900
AC-10-S	200	215	1000
AC-15-S	200	215	1500
AC-09-E	195	220	900
AC-10-E	195	220	1000
AC-15-E	195	220	1500
AC-20-E	195	220	2000

## Alphabetical Index of References. FANS

CA	196	CJTHT	325	HC	27	KIT BOXPDS	385
CAS	199	CJTSA	165	HCD	35	KIT SOBREPRESIÓN	381
CAS-S	199	CJTX-C	351	HCDF	397	NEOLINEO/V	19
CBD	120	CMA	188	HCH	37	NEOSILENT	21
CBX	126	CMA/ATEX	404	HCH/ATEX	400	RECUP	419
CBXC	126	CMP	175	HCT	37	RFH	222
CBXR	126	CMP/ATEX	406	HCT/ATEX	400	RFV	222
CBXT	126	CMR	183	HCT/IMP	54	SV/FILTER	423
CDXR	144	CMR/ATEX	410	HCT/IMP-C	52	SVE	13
CDXRT	144	CMX	111	HDF	397	SVE/PLUS	13
CI	335	CPV	191	HFW	57	TCR/R	346
CI-CO	110	CRF	227	HGI	33	THT	272
CJBD/ALG	123	CSX	365	HGT	75	THT/IMP	331
CJBX/ALG	136	CSXR	153	HGTX	75	THT/ROOF	343
CJBR	169	CSXRT	153	HPX	102	TSA	165
CJDXR	144	CXT	217	HT	230	TSAT	165
CJHCH	49	ECONOMIC	447	HTMF	336	UDT	431
CJSX	359	EDMF	24	HTMH	233	UDTX	437
CJSXR	153	HATCH PDS	387	HTMV	240	UFR	427
CJTCR/R	346	HBA	105	HTP	62	VC-HDU	208





EFFICIENT WORK FANS



# SOLution DEVELOPMENT CAPACITY

Fast and flexible industrial fan solutions and tailored fans

Large experience in smoke control systems and ATEX applications

Wide range of certified products for specific markets

AXIAL FANS AND  
ROOF-MOUNTED EXTRACTOR  
FANS



IN-LINE CENTRIFUGAL FANS  
AND EXTRACTORS



SMOKE  
EXTRACTOR  
FANS



HEAVY DUTY FANS  
AND EXTRACTOR FANS FOR  
ATEX EXPLOSIVE ATMOSPHERES



HEAT RECOVERY UNITS, FILTER  
UNITS  
AND TREATMENT UNITS



AIR CURTAINS FOR  
COMMERCIAL AND INDUSTRIAL  
APPLICATIONS



EXTRACTION SYSTEMS FOR  
HOMES



ASK US FOR  
INFORMATION



[www.sodeca.com](http://www.sodeca.com)



## HEADQUARTER

**Sodeca, S.L.U.**  
Pol. Ind. La Barricona  
Carrer del Metall, 2  
E-17500 Ripoll  
Girona, SPAIN  
Tel. +34 93 852 91 11  
Fax: +34 93 852 90 42  
General sales:  
comercial@sodeca.com  
Export sales:  
ventilation@sodeca.com

## PRODUCTION PLANT

**Sodeca, S.L.U.**  
Ctra. de Berga, km 0,7  
E-08580 Sant Quirze de  
Besora  
Barcelona, SPAIN  
Tel. +34 93 852 91 11  
Fax: +34 93 852 90 42  
General sales:  
comercial@sodeca.com  
Export sales:  
ventilation@sodeca.com



## EUROPE

### FINLAND

**Sodeca Finland, Oy**  
HUITTINEN  
Sales and Warehouse  
Mr. Kai Yli-Sipilä  
Metsälinnankatu 26  
FI-32700 Huitinen  
Tel. + 358 400 320 125  
orders.finland@sodeca.com

HELSINKI  
Smoke Control Solutions  
Mr. Antti Kontkanen  
Viilpulantie 9C  
FI-00700 Helsinki  
Tel. +358 400 237 434  
akontkanen@sodeca.com

HYVINKÄÄ  
Industrial Applications  
Mr. Jaakko Tomperi  
Niinistökatu 12  
FI-05800 Hyvinkää  
Tel. +358 451 651 333  
jtomperi@sodeca.com

### ITALIA

**Marelli Ventilazione, S.R.L.**  
Viale del Lavoro, 28  
37036 San Martino B.A.  
(VR), ITALY  
Tel. +39 045 87 80 140  
vendite@sodeca.com

### PORTUGAL

**Sodeca Portugal, Unip. Lda.**  
PORTO  
Rua Veloso Salgado 1120/1138  
4450-801 Leça de Palmeira  
Tel. +351 229 991 100  
geral@sodeca.pt

LISBOA  
Pq. Emp. da Granja Pav. 29  
2625-607 Vialonga  
Tel. +351 219 748 491  
geral@sodeca.pt

ALGARVE  
Rua da Alegria, 33  
8200-569 Ferreiras  
Tel. +351 289 092 586  
geral@sodeca.pt

### UNITED KINGDOM

**Sodeca Fans UK, Ltd.**  
Mr. Mark Newcombe  
Tamworth Enterprise Centre  
Philip Dix House, Corporation  
Street, Tamworth, B79 7DN  
UNITED KINGDOM  
Tel. +44 (0) 1827 216 109  
sales@sodeca.co.uk

## AMERICA

### CHILE

**Sodeca Ventiladores, SpA.**  
Sra. Sofía Ormazábal  
Santa Bernardita 12.005  
(Esquina con Puerta Sur)  
Bodegas 24 a 26,  
San Bernardo, Santiago, CHILE  
Tel. +56 22 840 5582  
ventas.chile@sodeca.com

### COLOMBIA

**Sodeca Latam, S.A.S.**  
Sra. Luisa Stella Prieto  
Calle7 No. 13 A-44  
Manzana 4 Lote1, Montaña  
Mosquera, Cundinamarca  
Bogotá, COLOMBIA  
Tel. +57 1 756 4213  
ventascolombia@sodeca.co

### PERU

**Sodeca Perú, S.A.C.**  
Sr. Jose Luis Jiménez  
C/ Mariscal Jose Luis de  
Orbegoso 331. Urb. El pino.  
15022, San Luis. Lima, PERÚ  
Tel. +51 1 326 24 24  
Cel. +51 994671594  
comercial@sodeca.pe



#### HEADQUARTER

**Sodeca, S.L.U.**  
 Pol. Ind. La Barricona  
 Carrer del Metall, 2  
 E-17500 Ripoll  
 Girona, SPAIN  
 Tel. +34 93 852 91 11  
 Fax: +34 93 852 90 42  
 General sales: comercial@sodeca.com  
 Export sales: ventilation@sodeca.com

#### PRODUCTION PLANT

**Sodeca, S.L.U.**  
 Ctra. de Berga, km 0,7  
 E-08580 Sant Quirze de Besora  
 Barcelona, SPAIN  
 Tel. +34 93 852 91 11  
 Fax: +34 93 852 90 42  
 General sales: comercial@sodeca.com  
 Export sales: ventilation@sodeca.com



[www.sodeca.com](http://www.sodeca.com)

