

HCT/EC

Tubular axial fans, with EC Technology IE5 motor



← EC TECHNOLOGY MOTOR with integrated electronics



← EC CONTROL Supplied as an optional accessory

Tubular axial fans with EC Technology IE5 motor with integrated electronics, specially designed for high energy efficiency.

Fan:

- Airflow direction from motor to impeller.
- Fibreglass reinforced polyamide-6 impeller. AL version made of cast aluminium.
- Long tubular casing in sheet steel with external terminal box.

Motor:

- High efficiency EC Technology motors with integrated electronics, regulated by 0-10 V or 4-20 mA.
- IE5 efficiency motors, class F and IP55 protection.
- Single-phase 230 V 50/60 Hz and three-phase 400 V 50/60 Hz.
- Working temperature: -25 °C +60 °C.

EC CONTROL: Supplied as an optional accessory. Control panel for ventilation

systems with EC Technology motors with the electronics integrated in the motor itself. With the following characteristics:

- CPC: Constant pressure control.
- CFC: Constant flow control.
- DAY/NIGHT: Double pressure setpoint adjustment according to time of day.
- External sensor: compatible with temperature, humidity, air quality or CO sensor.
- Equipment preconfigured in constant pressure mode with 100 Pa set point.

Finish:

- Anti-corrosive finish in polyester resin, polymerised at 190 °C, after degreasing with phosphate-free nanotechnology treatment.

On request:

- Airflow direction from impeller to motor.
- 100% reversible impellers.

Order code

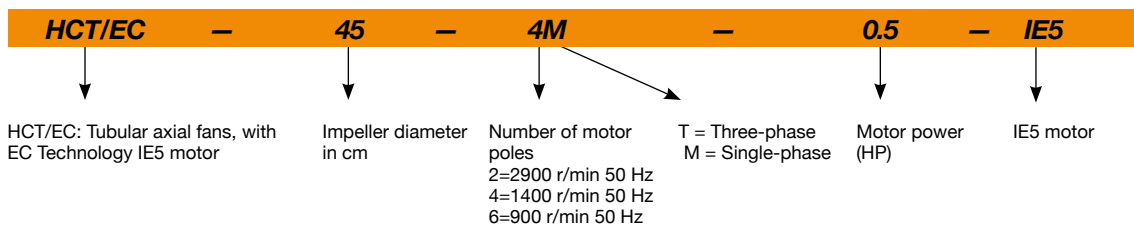

Technical characteristics

Model	Speed (r/min)	Maximum admissible current (A)		Max. electric power (kW)	Maximum flow rate (m³/h)	Sound pressure level dB (A)	Approx. weight (Kg)	According ErP*
		230V	400V					
HCT/EC-45-2T-3 IE5	2910		6.1	2.20	12750	88	39	2020
HCT/EC-45-4M-0.5 IE5	1400	3.4		0.37	7100	68	24	2020
HCT/EC-50-4M-0.75 IE5	1350	4.8		0.55	10400	70	28	2020
HCT/EC-56-4M-1.5 IE5	1455	8.9		1.10	14000	74	40	2020
HCT/EC-63-4M-1.5 IE5	1455	8.9		1.10	17000	74	49	2020
HCT/EC-63-4T-3 IE5	1435		5.9	2.20	22100	76	58	2020
HCT/EC-71-4T-3 IE5	1435		5.9	2.20	23950	81	65	2020
HCT/EC-71-6M-1 IE5	940	5.9		0.75	17250	68	58	2020
HCT/EC-80-4T-3 IE5	1435		5.9	2.20	28000	82	73	2020
HCT/EC-80-4T-5.5 IE5	1450		10.6	4.00	37200	84	81	2020
HCT/EC-90-4T-5.5 IE5	1450		10.6	4.00	41850	89	97	2020
HCT/EC-90-6T-3 IE5	950		7.5	2.20	35000	78	96	2020
HCT/EC-100-6T-3 IE5	950		7.5	2.20	40500	82	107	2020

* In accordance with the ErP 2020 draft

Acoustic characteristics

The indicated values are determined by measuring the pressure and sound power levels in dB(A) obtained in a free field at a distance equivalent to twice the size of the fan plus the impeller diameter, with a minimum of 1.5 m.

Sound power spectrum Lw(A) in dB(A) per Hz frequency band

	63	125	250	500	1000	2000	4000	8000
HCT/EC-45-2T-3	53	70	82	90	95	95	91	84
HCT/EC-45-4M-0.5	33	50	62	70	75	75	71	64
HCT/EC-50-4M-0.75	37	54	67	74	79	80	75	68
HCT/EC-56-4M-1.5	49	69	77	82	84	81	74	63
HCT/EC-63-4M-1.5	51	71	79	84	86	83	76	65
HCT/EC-63-4T-3	53	73	81	86	88	85	78	67
HCT/EC-71-4T-3	58	78	86	91	93	90	83	72
HCT/EC-71-6M-1	45	65	73	78	80	77	70	59
HCT/EC-80-4T-3	59	79	87	92	94	91	84	73
HCT/EC-80-4T-5.5	61	81	89	94	96	93	86	75
HCT/EC-90-4T-5.5	67	88	95	100	103	99	92	81
HCT/EC-90-6T-3	56	77	84	89	92	88	81	70
HCT/EC-100-6T-3	62	82	90	95	97	94	87	76

Dimensions mm

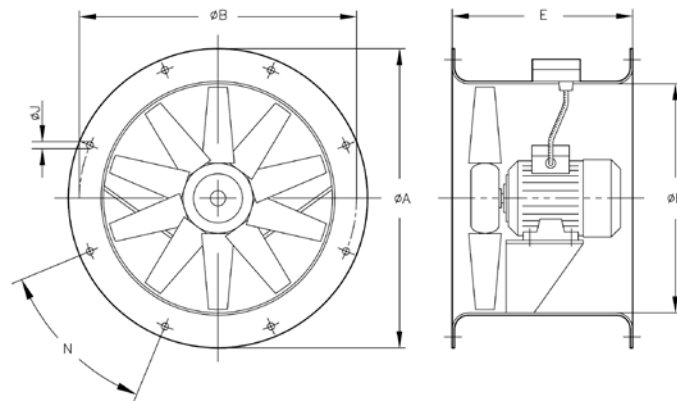

	ØA	ØB	ØD	E	ØJ	N
HCT/EC-45	540	500	460	360	12	8x45°
HCT/EC-50	600	560	514	360	12	12x30°
HCT/EC-56	660	620	560	400	12	12x30°
HCT/EC-63	730	690	640	430	12	12x30°
HCT/EC-71	810	770	710	500	12	16x22°30'
HCT/EC-80	900	860	800	500	12	16x22°30'
HCT/EC-90	1015	970	900	500	15	16x22°30'
HCT/EC-100	1115	1070	1000	600	15	16x22°30'

Characteristic curves

Q= Flow rate in m³/h, m³/s and cfm

Pe= Static pressure in mm H₂O, Pa and inwg

HCT/EC-45-2T-3

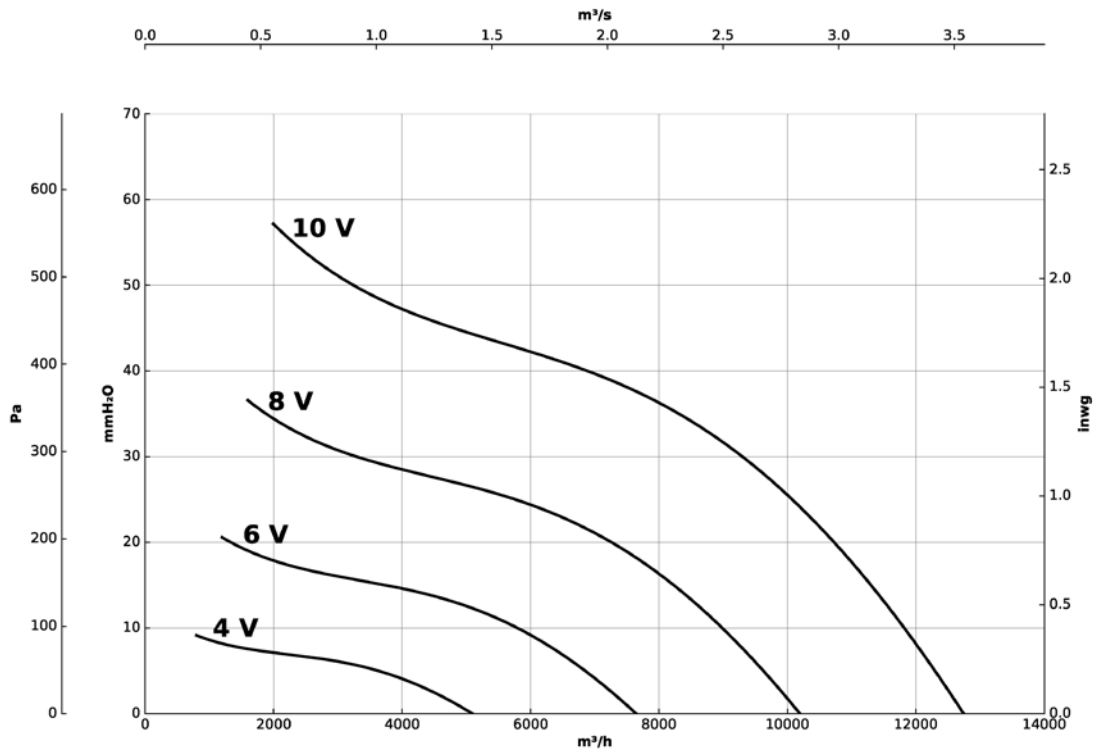

HCT/EC-45-4M-0.5

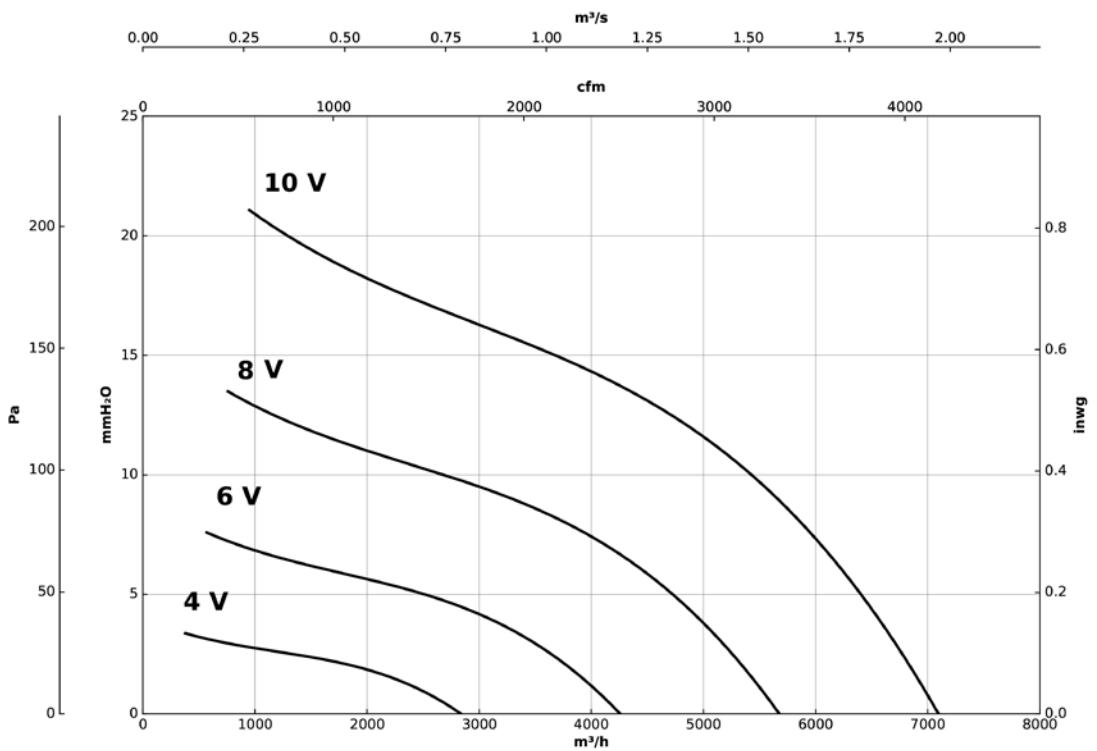

Characteristic curves

Q= Flow rate in m³/h, m³/s and cfm

Pe= Static pressure in mm H₂O, Pa and inwg

HCT/EC-50-4M-0.75

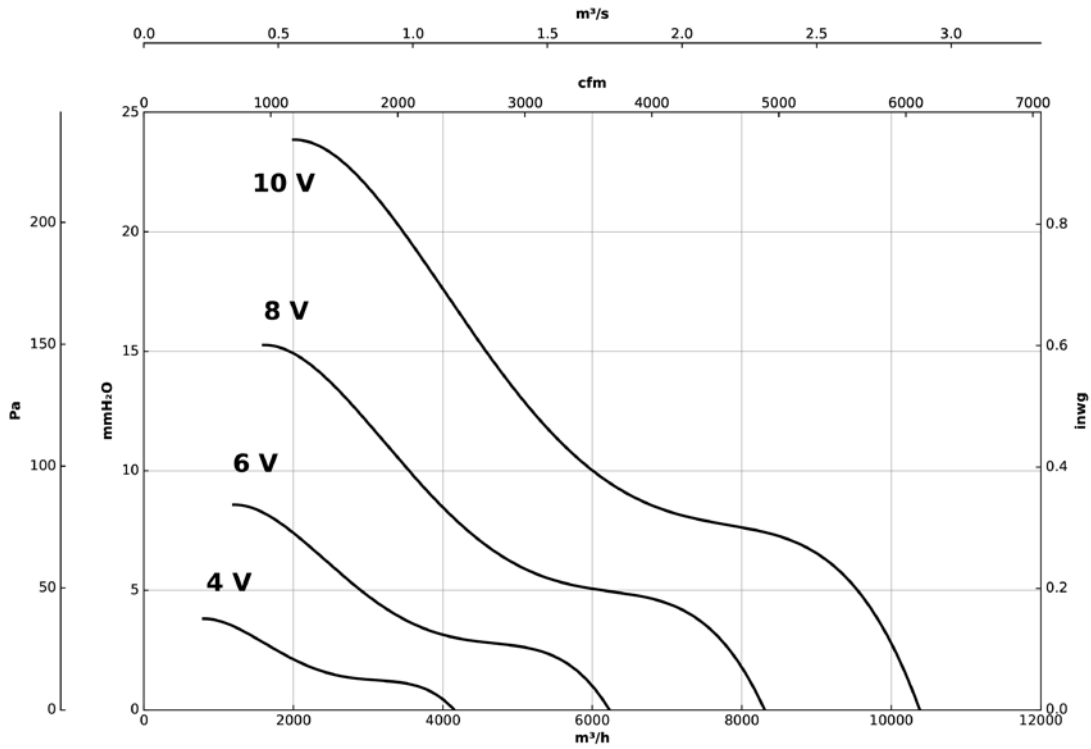

HCT/EC-56-4M-1.5

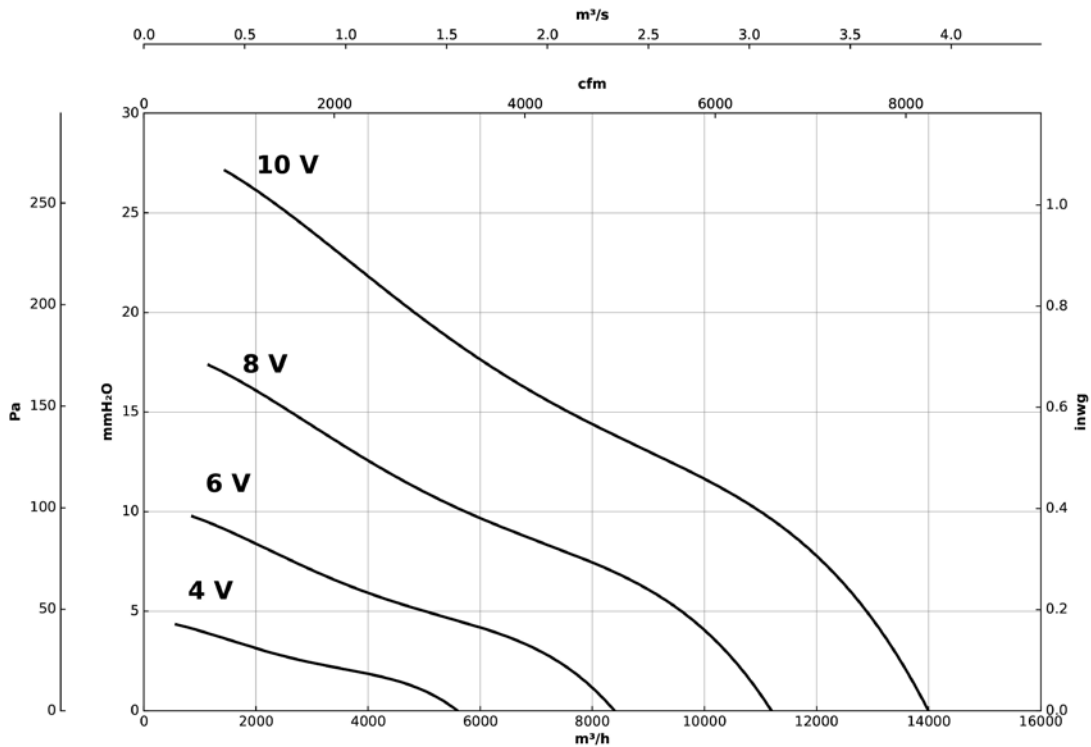

Characteristic curves

Q= Flow rate in m³/h, m³/s and cfm

Pe= Static pressure in mm H₂O, Pa and inwg

HCT/EC-63-4M-1.5

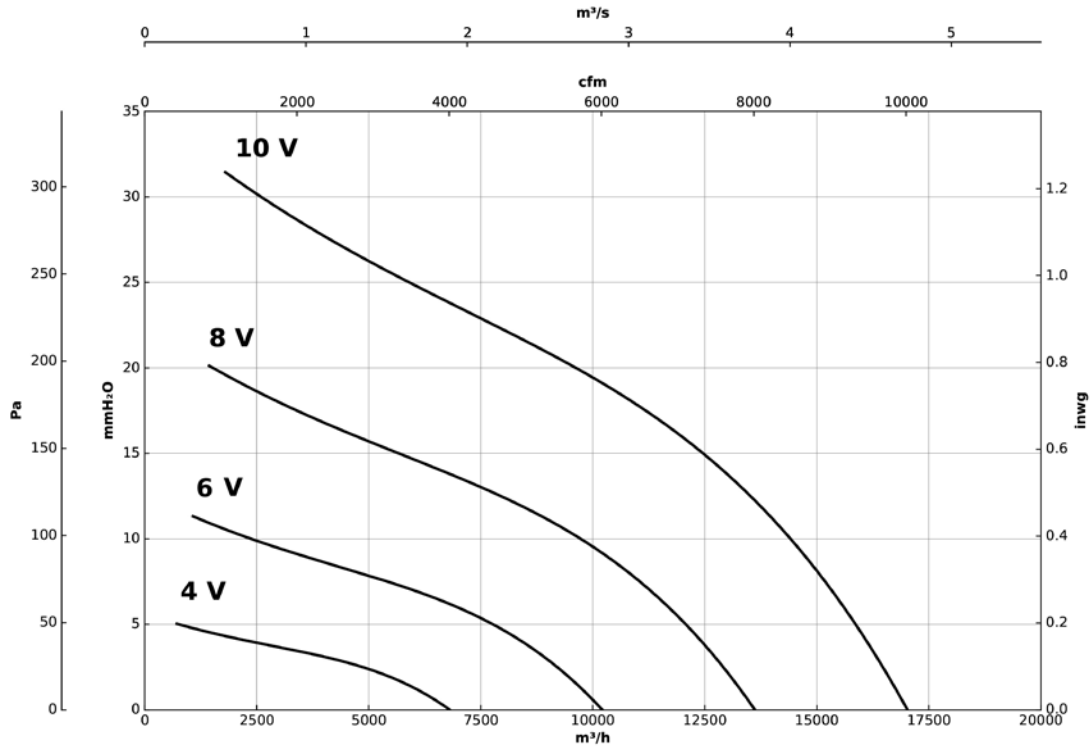

HCT/EC-63-4T-3

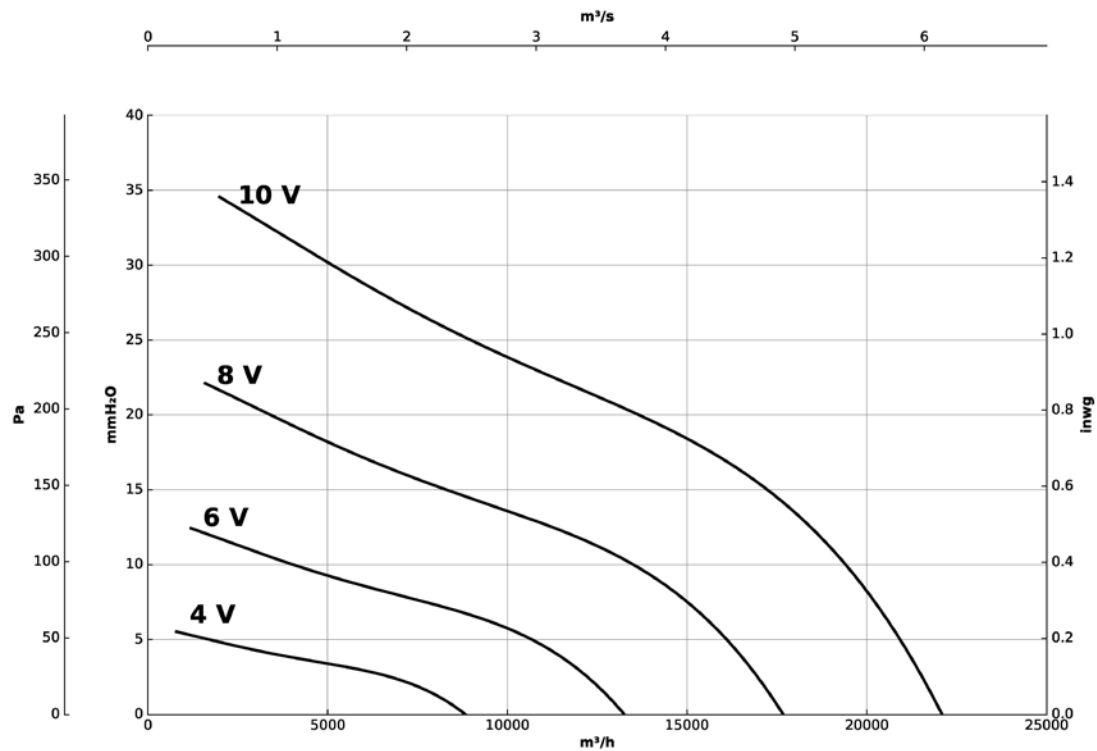

Characteristic curves

Q= Flow rate in m³/h, m³/s and cfm

Pe= Static pressure in mm H₂O, Pa and inwg

HCT/EC-71-4T-3

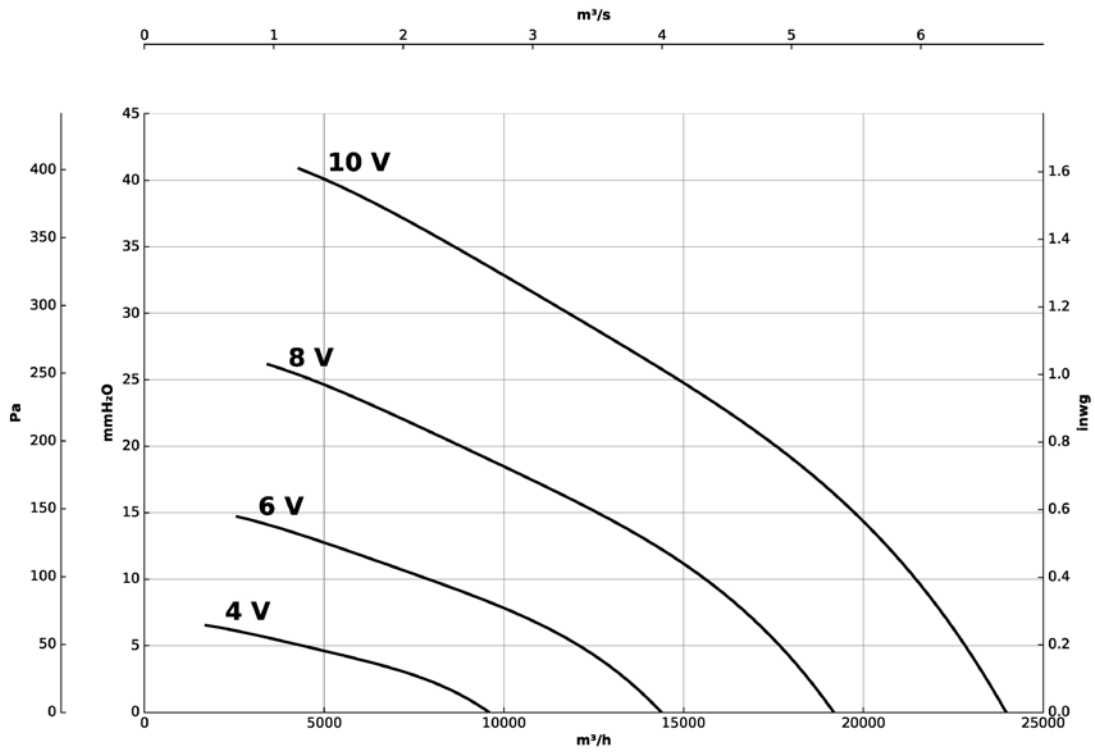

HCT/EC-71-6M-1

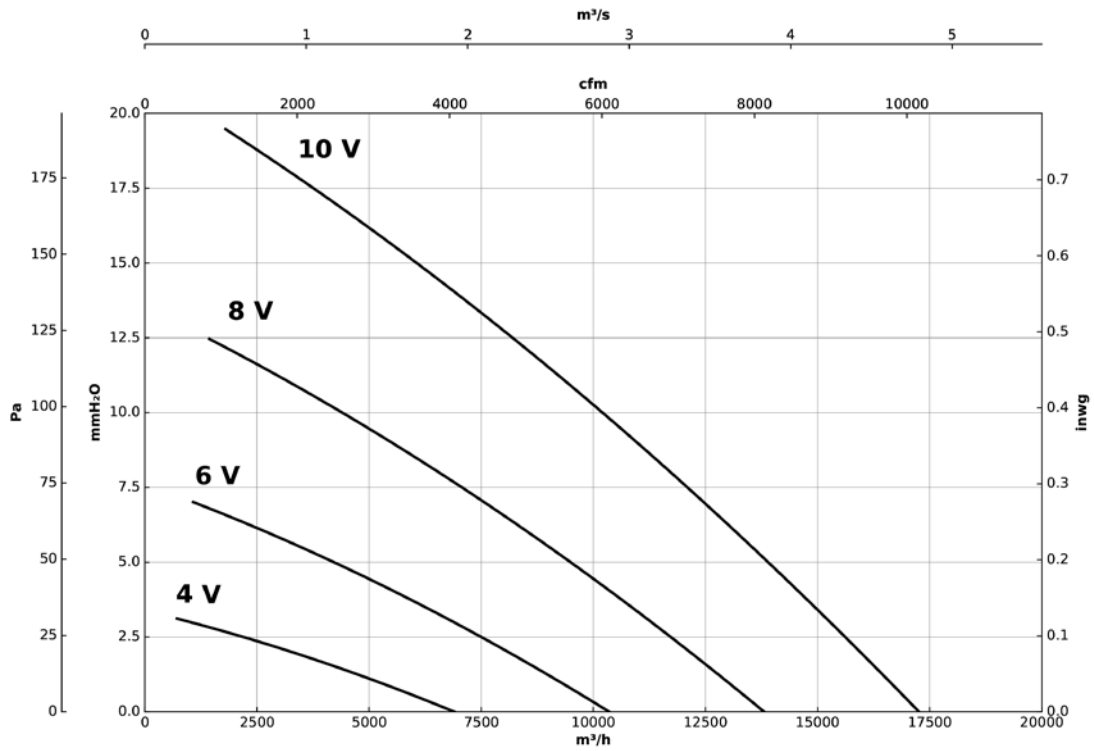

Characteristic curves

Q= Flow rate in m³/h, m³/s and cfm

Pe= Static pressure in mm H₂O, Pa and inwg

HCT/EC-80-4T-3

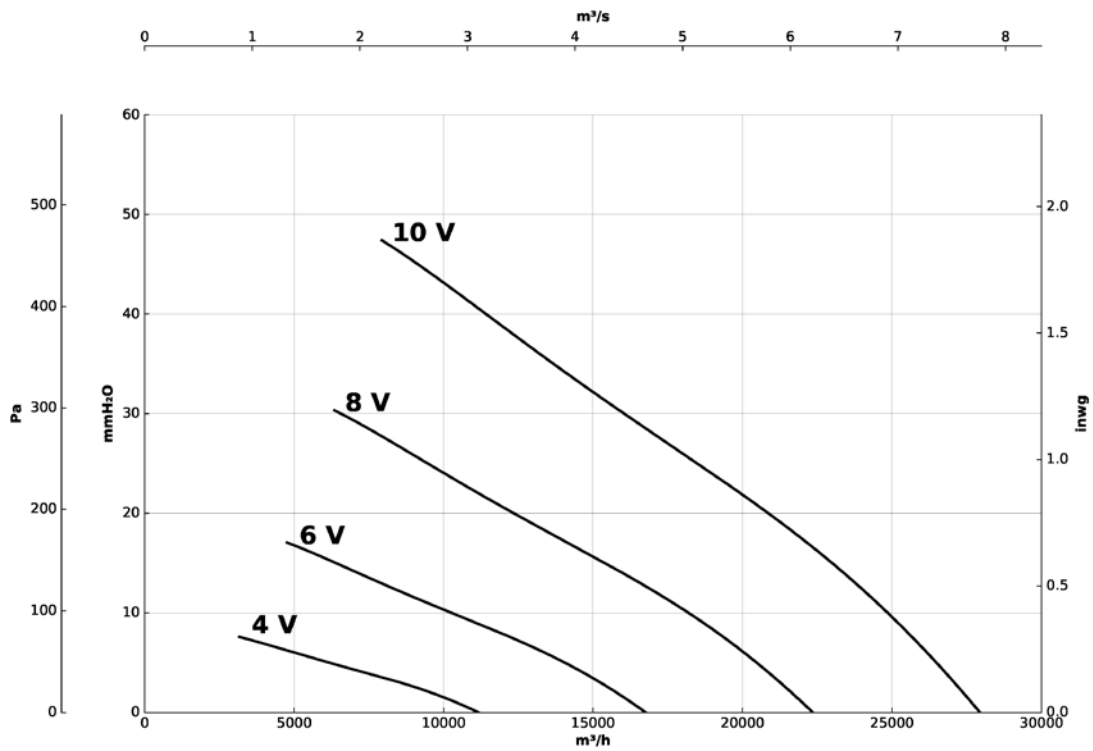

HCT/EC-80-4T-5.5

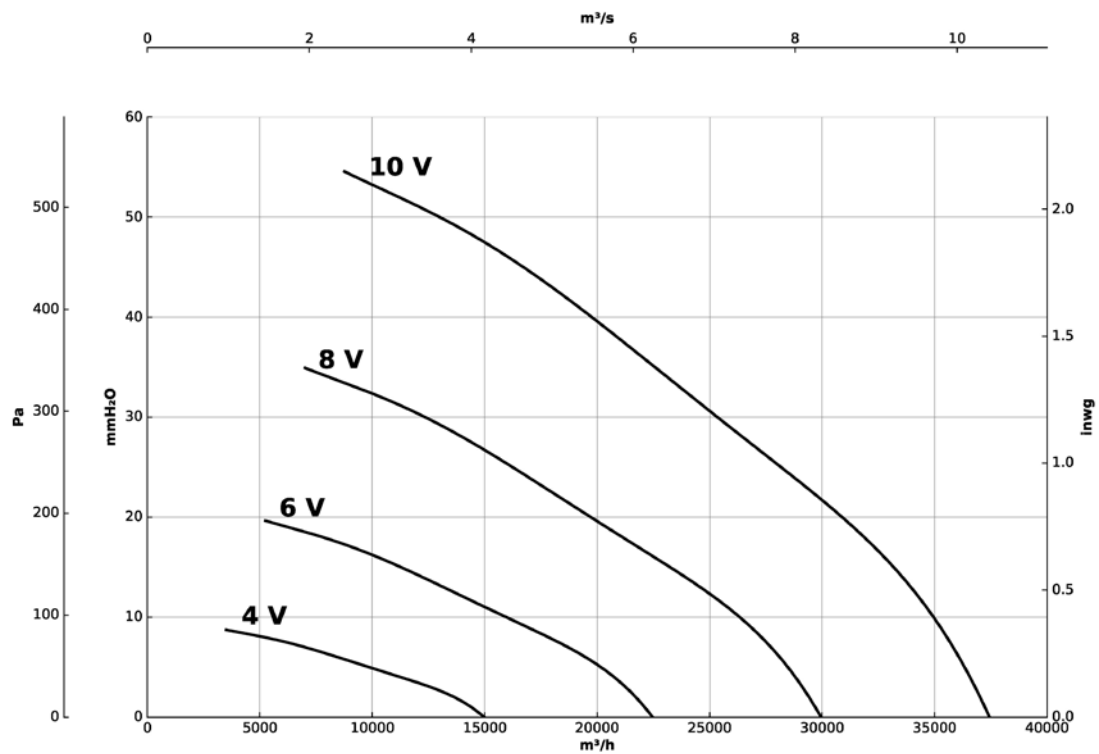

Characteristic curves

Q= Flow rate in m³/h, m³/s and cfm

Pe= Static pressure in mm H₂O, Pa and inwg

HCT/EC-90-4T-5.5

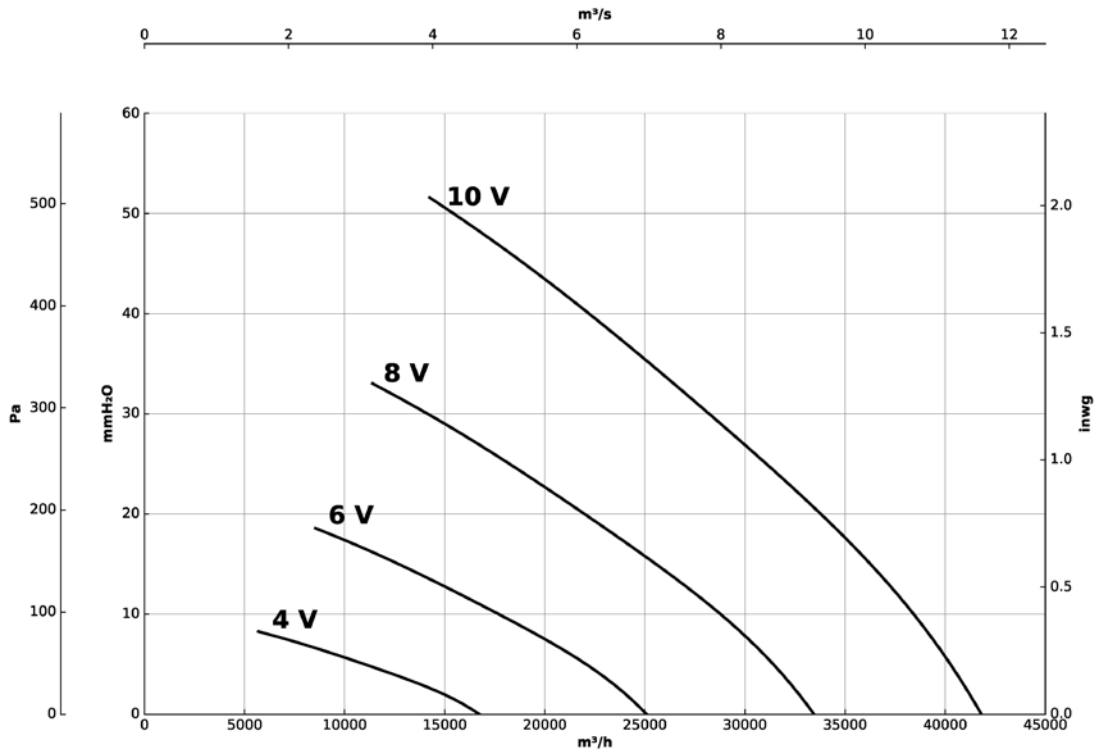

HCT/EC-90-6T-3

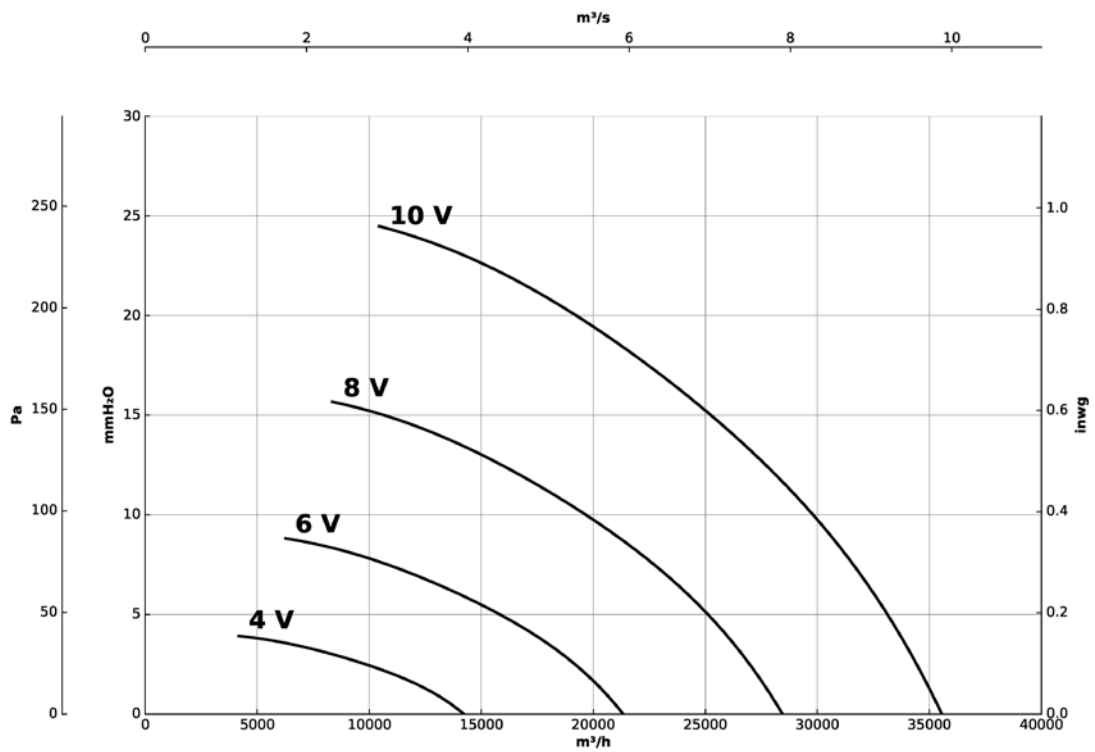

Characteristic curves

Q= Flow rate in m³/h, m³/s and cfm

Pe= Static pressure in mm H₂O, Pa and inwg

HCT/EC-100-6T-3

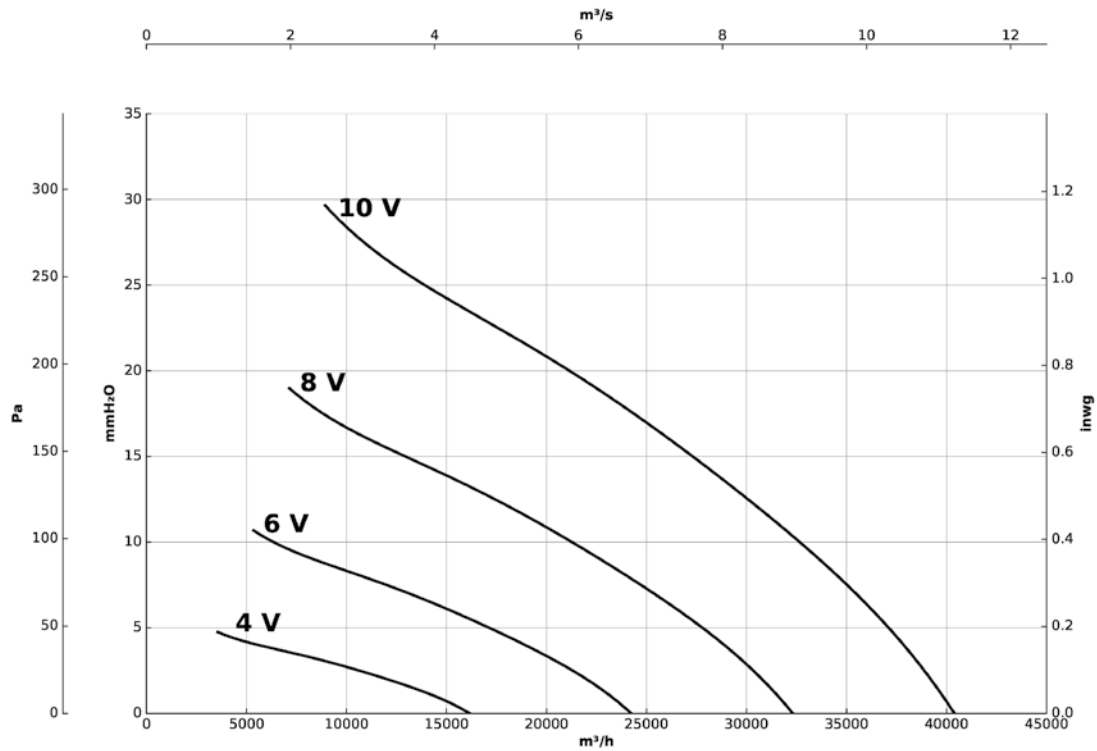

Accessories

